

Ergebnis: **417.8** (397)
 Serien: 105.0 103.9 104.8 104.1
 Zähler: 37 3 0 0 0 0 0 0 0 0
 Innenzehner: 33
 weiteste: 287 (23), 265 (35), 261 (30)
 beste Teiler 1.0 (15.) 9.0 (5.) 14.8 (26.)
 Trefferlage 0.34 mm links, 0.10 mm tief
 Streuwert 1.02, horizontal: 1.17, vertikal: 0.84

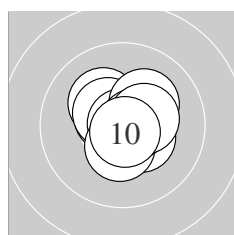

Serie 1:
 10.2 * 10.6 * 10.5 * 10.4 * 10.9 *
 10.2 * 10.4 * 10.6 * 10.4 * 10.8 *
 beste Teiler 9.0 (5.) 45.5 (10.) 78.4 (8.)
 Trefferlage 0.15 mm rechts, 0.21 mm hoch
 Streuwert 0.93, horizontal: 0.97, vertikal: 0.88

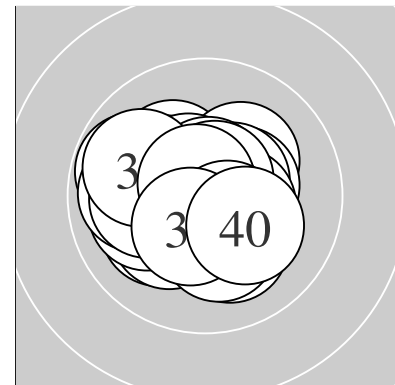
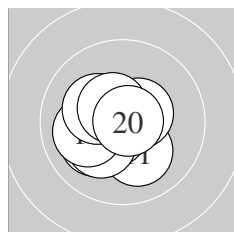

Serie 2:
 10.1 ↘ 10.5 * 10.1 ↙ 10.6 * 10.9 *
 10.2 * 10.0 ← 10.2 * 10.5 * 10.8 *
 beste Teiler 1.0 (15.) 35.9 (20.) 87.6 (14.)
 Trefferlage 0.59 mm links, 0.31 mm tief
 Streuwert 1.05, horizontal: 1.14, vertikal: 0.95

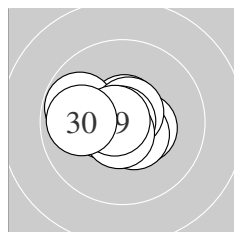

Serie 3:
 10.6 * 10.4 * 9.8 ↖ 10.5 * 10.7 *
 10.9 * 10.5 * 10.7 * 10.8 * 9.9 ←
 beste Teiler 14.8 (26.) 50.8 (29.) 72.2 (25.)
 Trefferlage 0.48 mm links, 0.05 mm hoch
 Streuwert 1.02, horizontal: 1.32, vertikal: 0.59

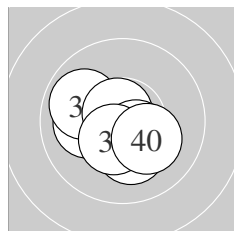

Serie 4:
 10.7 * 10.5 * 10.1 ← 10.9 * 9.9 ↖
 10.7 * 10.2 * 10.5 * 10.4 * 10.2 *
 beste Teiler 24.5 (34.) 59.0 (36.) 68.1 (31.)
 Trefferlage 0.46 mm links, 0.36 mm tief
 Streuwert 1.08, horizontal: 1.25, vertikal: 0.87

Unterschrift des Schützen

Meyton Elektronik

Ergebnis: **415.6** (393)
 Serien: 106.4 102.2 102.6 104.4
 Zähler: 33 7 0 0 0 0 0 0 0 0
 Innenzehner: 33
 weiteste: 420 (27), 400 (16), 347 (18)
 beste Teiler 8.0 (1.) 10.7 (28.) 35.0 (7.)
 Trefferlage 0.59 mm links, 0.32 mm hoch
 Streuwert 1.16, horizontal: 1.34, vertikal: 0.96

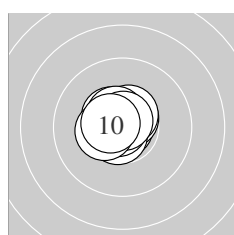
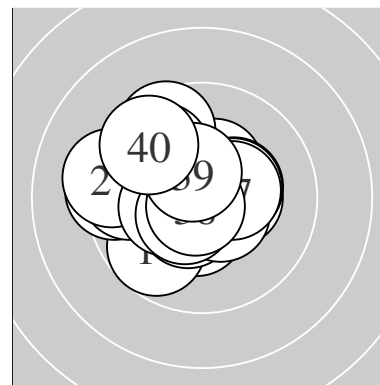

Serie 1:
 10.9 * 10.6 * 10.5 * 10.5 * 10.7 *
 10.6 * 10.8 * 10.8 * 10.4 * 10.6 *
 beste Teiler 8.0 (1.) 35.0 (7.) 48.2 (8.)
 Trefferlage 0.33 mm links, 0.31 mm hoch
 Streuwert 0.57, horizontal: 0.61, vertikal: 0.53

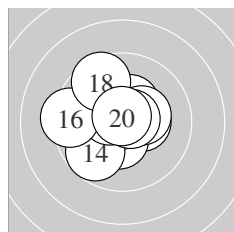

Serie 2:
 10.4 * 10.4 * 10.4 * 9.7 ✓ 10.5 *
 9.4 ← 10.3 * 9.6 ↘ 10.7 * 10.8 *
 beste Teiler 46.5 (20.) 65.0 (19.) 110.4 (15.)
 Trefferlage 0.50 mm links, 0.29 mm hoch
 Streuwert 1.56, horizontal: 1.71, vertikal: 1.41

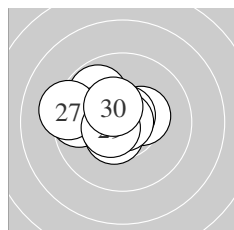

Serie 3:
 10.4 * 10.4 * 9.8 ↘ 10.7 * 9.6 ←
 10.5 * 9.3 ← 10.9 * 10.6 * 10.4 *
 beste Teiler 10.7 (28.) 56.3 (24.) 99.7 (29.)
 Trefferlage 1.11 mm links, 0.45 mm hoch
 Streuwert 1.31, horizontal: 1.65, vertikal: 0.84

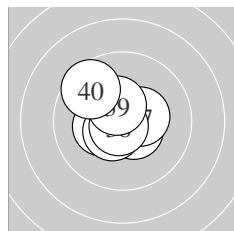

Serie 4:
 10.7 * 10.5 * 10.5 * 10.3 * 10.5 *
 10.6 * 10.4 * 10.8 * 10.5 * 9.6 ↘
 beste Teiler 48.4 (38.) 70.4 (31.) 78.7 (36.)
 Trefferlage 0.40 mm links, 0.23 mm hoch
 Streuwert 1.06, horizontal: 1.13, vertikal: 0.99

Unterschrift des Schützen

Meyton Elektronik

Ergebnis: **405.2** (387)
 Serien: 99.2 102.8 100.4 102.8
 Zähler: 30 7 3 0 0 0 0 0 0 0
 Innenzehner: 24
 weiteste: 683 (2), 567 (6), 526 (21)
 beste Teiler 51.8 (34.) 60.0 (7.) 60.4 (5.)
 Trefferlage 0.70 mm rechts, 0.12 mm tief
 Streuwert 1.72, horizontal: 2.10, vertikal: 1.22

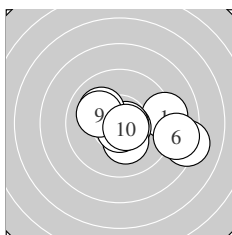
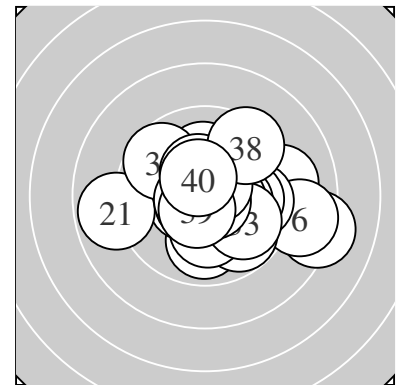

Serie 1:
 9.2 → 8.2 → 10.6 * 10.2 * 10.7 *
 8.7 → 10.7 * 10.1 ↖ 10.1 ↖ 10.7 *
 beste Teiler 60.0 (7.) 60.4 (5.) 73.4 (10.)
 Trefferlage 1.53 mm rechts, 0.36 mm tief
 Streuwert 2.22, horizontal: 2.94, vertikal: 1.09

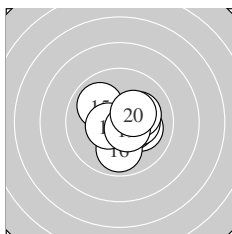

Serie 2:
 10.1 → 10.4 * 10.3 * 10.5 * 10.0 ↖
 9.9 ↓ 10.5 * 10.2 * 10.6 * 10.3 *
 beste Teiler 98.5 (19.) 102.0 (14.) 115.4 (17.)
 Trefferlage 0.57 mm rechts, 0.25 mm tief
 Streuwert 1.24, horizontal: 1.31, vertikal: 1.16

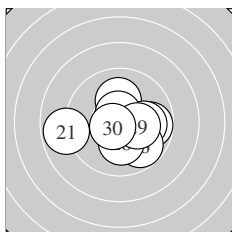

Serie 3:
 8.8 ← 10.3 * 10.1 ↑ 9.8 → 10.0 →
 9.8 ↘ 10.6 * 10.2 * 10.2 * 10.6 *
 beste Teiler 79.2 (27.) 80.4 (30.) 175.5 (22.)
 Trefferlage 0.47 mm rechts, 0.39 mm tief
 Streuwert 1.87, horizontal: 2.34, vertikal: 1.22

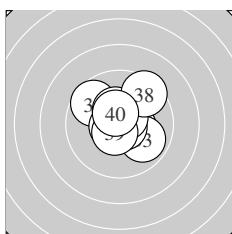

Serie 4:
 10.4 * 9.7 ↖ 9.9 ↘ 10.7 * 10.4 *
 10.6 * 10.6 * 9.4 ↗ 10.6 * 10.5 *
 beste Teiler 51.8 (34.) 77.2 (37.) 83.2 (36.)
 Trefferlage 0.23 mm rechts, 0.49 mm hoch
 Streuwert 1.42, horizontal: 1.49, vertikal: 1.36

Unterschrift des Schützen

Ergebnis: **406.7** (392)
 Serien: 102.4 99.4 103.0 101.9
 Zähler: 32 8 0 0 0 0 0 0 0 0
 Innenzehner: 23
 weiteste: 483 (15), 353 (39), 331 (17)
 beste Teiler 62.6 (28.) 74.2 (25.) 82.9 (6.)
 Trefferlage 0.34 mm links, 0.11 mm hoch
 Streuwert 1.50, horizontal: 1.75, vertikal: 1.20

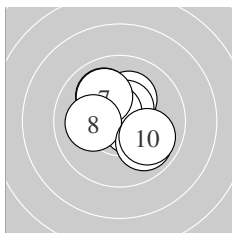
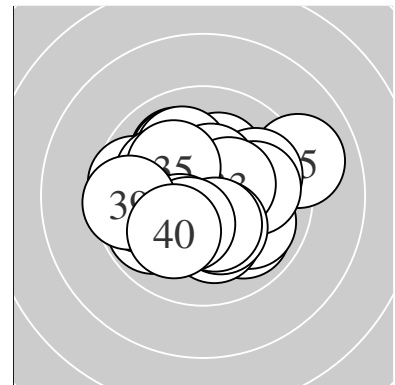

Serie 1:
 10.6 * 10.6 * 10.0 ↗ 10.2 * 10.5 *
 10.6 * 10.0 ↘ 10.1 ← 9.9 ↘ 9.9 ↘
 beste Teiler 82.9 (6.) 86.5 (1.) 99.3 (2.)
 Trefferlage 0.07 mm rechts, 0.46 mm hoch
 Streuwert 1.36, horizontal: 1.41, vertikal: 1.30

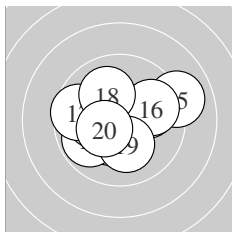

Serie 2:
 10.3 * 9.8 ↙ 10.0 → 10.2 * 9.0 →
 9.9 → 9.6 ← 10.0 ↘ 10.2 * 10.4 *
 beste Teiler 138.7 (20.) 155.7 (11.) 197.0 (14.)
 Trefferlage 0.07 mm links, 0.06 mm hoch
 Streuwert 2.00, horizontal: 2.48, vertikal: 1.38

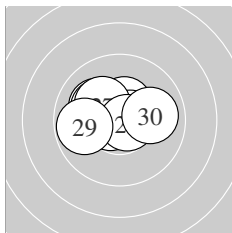

Serie 3:
 10.3 * 10.4 * 10.1 ↖ 10.6 * 10.7 *
 10.2 * 10.2 * 10.7 * 9.8 ← 10.0 →
 beste Teiler 62.6 (28.) 74.2 (25.) 86.1 (24.)
 Trefferlage 0.53 mm links, 0.53 mm hoch
 Streuwert 1.20, horizontal: 1.56, vertikal: 0.68

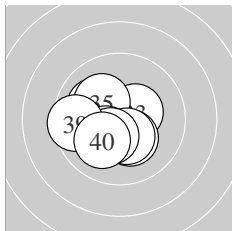

Serie 4:
 10.1 ↖ 10.3 * 10.4 * 10.3 * 10.2 *
 10.3 * 10.4 * 10.3 * 9.5 ← 10.1 ↙
 beste Teiler 135.1 (33.) 148.3 (37.) 152.5 (38.)
 Trefferlage 0.85 mm links, 0.58 mm tief
 Streuwert 1.30, horizontal: 1.43, vertikal: 1.16

Unterschrift des Schützen

Meyton Elektronik

Ergebnis: **414.4** (396)
 Serien: 102.3 103.9 104.2 104.0
 Zähler: 36 4 0 0 0 0 0 0 0 0
 Innenzehner: 27
 weiteste: 382 (36), 290 (10), 268 (12)
 beste Teiler 25.4 (38.) 34.2 (1.) 34.2 (40.)
 Trefferlage 0.05 mm links, 0.13 mm hoch
 Streuwert 1.22, horizontal: 1.42, vertikal: 0.99

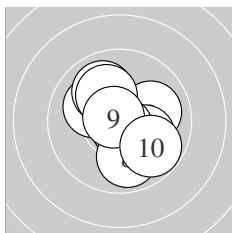
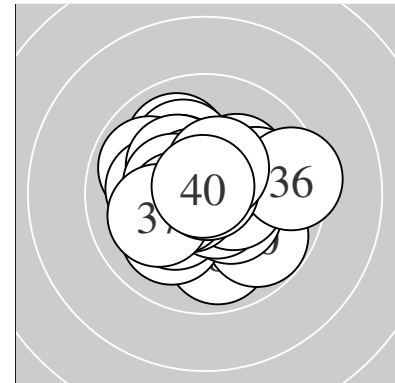

Serie 1:
 10.8 * 10.0 → 10.1 ↖ 10.0 ↗ 10.1 ↘
 10.1 ↘ 10.8 * 9.9 ↓ 10.7 * 9.8 ↘
 beste Teiler 34.2 (1.) 49.0 (7.) 52.6 (9.)
 Trefferlage 0.23 mm rechts, 0.04 mm hoch
 Streuwert 1.50, horizontal: 1.47, vertikal: 1.53

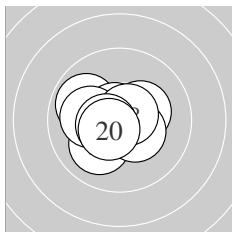

Serie 2:
 10.7 * 9.9 ↖ 10.7 * 10.1 ↗ 10.1 ←
 10.3 * 10.4 * 10.7 * 10.5 * 10.5 *
 beste Teiler 60.2 (13.) 68.8 (11.) 70.4 (18.)
 Trefferlage 0.54 mm links, 0.09 mm tief
 Streuwert 1.10, horizontal: 1.31, vertikal: 0.84

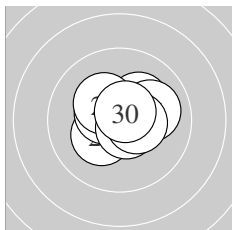

Serie 3:
 10.3 * 10.2 * 10.7 * 10.3 * 10.5 *
 10.0 → 10.3 * 10.7 * 10.5 * 10.7 *
 beste Teiler 58.2 (23.) 73.4 (30.) 75.9 (28.)
 Trefferlage 0.34 mm rechts, 0.31 mm hoch
 Streuwert 1.05, horizontal: 1.28, vertikal: 0.74

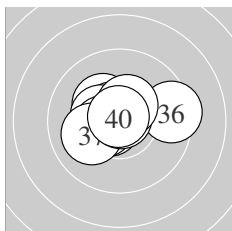

Serie 4:
 10.3 * 10.6 * 10.6 * 10.4 * 10.5 *
 9.4 → 10.1 ← 10.9 * 10.4 * 10.8 *
 beste Teiler 25.4 (38.) 34.2 (40.) 78.3 (32.)
 Trefferlage 0.26 mm links, 0.29 mm hoch
 Streuwert 1.24, horizontal: 1.61, vertikal: 0.68

Unterschrift des Schützen

Meyton Elektronik

Ergebnis: **412.5** (392)
 Serien: 101.4 105.5 104.1 101.5
 Zähler: 32 8 0 0 0 0 0 0 0 0
 Innenzehner: 28
 weiteste: 405 (37), 361 (10), 356 (32)
 beste Teiler 6.3 (15.) 16.5 (31.) 46.0 (38.)
 Trefferlage 0.17 mm rechts, 0.06 mm tief
 Streuwert 1.32, horizontal: 1.61, vertikal: 0.94

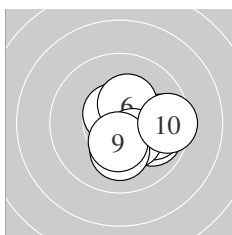
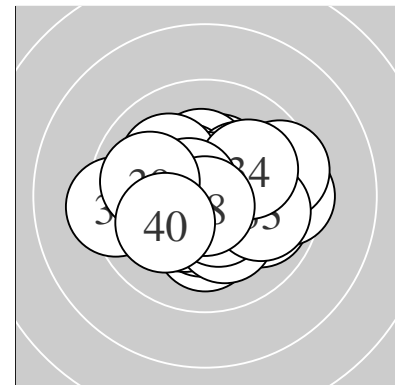

Serie 1:
 10.6 * 9.8 → 10.6 * 9.9 ↘ 9.9 →
 10.3 * 10.3 * 10.1 ↓ 10.4 * 9.5 →
 beste Teiler 80.4 (1.) 88.8 (3.) 140.4 (9.)
 Trefferlage 1.29 mm rechts, 0.46 mm tief
 Streuwert 1.26, horizontal: 1.46, vertikal: 1.03

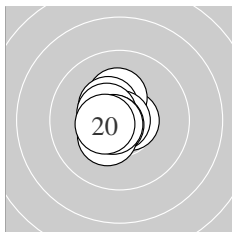

Serie 2:
 10.7 * 10.4 * 10.3 * 10.4 * 10.9 *
 10.5 * 10.7 * 10.4 * 10.7 * 10.5 *
 beste Teiler 6.3 (15.) 55.3 (17.) 59.3 (19.)
 Trefferlage 0.44 mm links, 0.23 mm hoch
 Streuwert 0.74, horizontal: 0.56, vertikal: 0.88

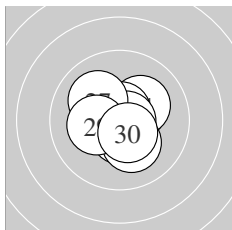

Serie 3:
 10.5 * 10.3 * 10.5 * 10.2 * 10.7 *
 10.8 * 10.1 ↖ 10.2 * 10.3 * 10.5 *
 beste Teiler 48.3 (26.) 63.7 (25.) 107.1 (23.)
 Trefferlage 0.04 mm rechts, 0.01 mm tief
 Streuwert 1.11, horizontal: 1.18, vertikal: 1.03

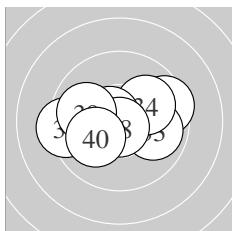

Serie 4:
 10.9 * 9.5 → 9.9 → 10.0 ↗ 10.6 *
 10.5 * 9.3 ← 10.8 * 9.9 ← 10.1 ↙
 beste Teiler 16.5 (31.) 46.0 (38.) 81.3 (35.)
 Trefferlage 0.21 mm links, 0.00 mm
 Streuwert 1.74, horizontal: 2.32, vertikal: 0.81

Unterschrift des Schützen

Ergebnis: **415.9** (396)
 Serien: 103.8 104.2 103.9 104.0
 Zähler: 36 4 0 0 0 0 0 0 0 0
 Innenzehner: 32
 weiteste: 313 (1), 312 (25), 253 (13)
 beste Teiler 18.0 (39.) 29.1 (14.) 43.4 (21.)
 Trefferlage 0.65 mm links, 0.04 mm hoch
 Streuwert 1.02, horizontal: 1.14, vertikal: 0.89

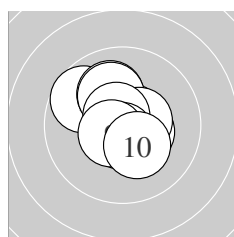
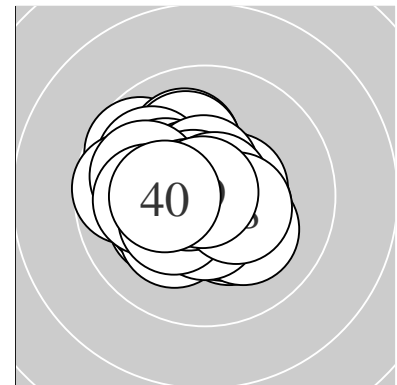

Serie 1:
 9.7 ↘ 10.7 * 10.4 * 10.1 ↗ 10.1 ↗
 10.5 * 10.7 * 10.7 * 10.6 * 10.3 *
 beste Teiler 71.5 (8.) 73.5 (2.) 75.7 (7.)
 Trefferlage 0.16 mm links, 0.42 mm hoch
 Streuwert 1.19, horizontal: 1.18, vertikal: 1.20

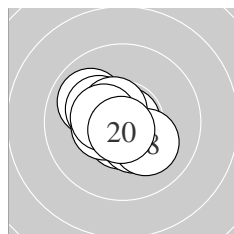

Serie 2:
 10.6 * 10.4 * 9.9 ↘ 10.8 * 10.2 *
 10.5 * 10.6 * 10.1 ↘ 10.4 * 10.7 *
 beste Teiler 29.1 (14.) 52.7 (20.) 91.2 (11.)
 Trefferlage 0.44 mm links, 0.08 mm tief
 Streuwert 1.03, horizontal: 1.13, vertikal: 0.92

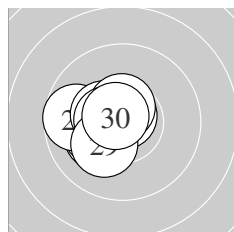

Serie 3:
 10.8 * 10.2 * 10.2 * 10.6 * 9.7 ←
 10.4 * 10.6 * 10.5 * 10.2 * 10.7 *
 beste Teiler 43.4 (21.) 63.1 (30.) 98.0 (24.)
 Trefferlage 1.15 mm links, 0.02 mm tief
 Streuwert 0.84, horizontal: 0.92, vertikal: 0.76

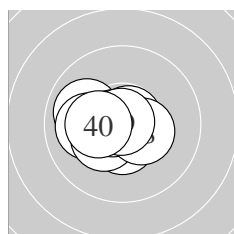

Serie 4:
 10.5 * 10.2 * 9.9 ↘ 10.0 ← 10.3 *
 10.8 * 10.7 * 10.4 * 10.9 * 10.3 *
 beste Teiler 18.0 (39.) 50.4 (36.) 66.1 (37.)
 Trefferlage 0.85 mm links, 0.11 mm tief
 Streuwert 0.96, horizontal: 1.23, vertikal: 0.59

Unterschrift des Schützen

Meyton Elektronik

Ergebnis: **408.4** (390)
 Serien: 101.2 102.7 102.8 101.7
 Zähler: 31 8 1 0 0 0 0 0 0
 Innenzehner: 26
 weiteste: 632 (32), 329 (20), 297 (2)
 beste Teiler 6.0 (12.) 54.7 (39.) 54.8 (21.)
 Trefferlage 0.12 mm rechts, 0.00 mm
 Streuwert 1.51, horizontal: 1.95, vertikal: 0.89

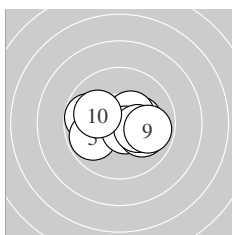
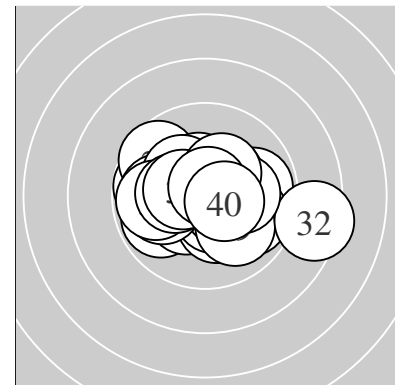

Serie 1:
 10.2 * 9.8 ← 10.2 * 10.4 * 9.8 ←
 10.6 * 10.0 → 10.2 * 9.9 → 10.1 ←
 beste Teiler 83.0 (6.) 130.0 (4.) 176.2 (8.)
 Trefferlage 0.03 mm rechts, 0.09 mm tief
 Streuwert 1.61, horizontal: 2.15, vertikal: 0.76

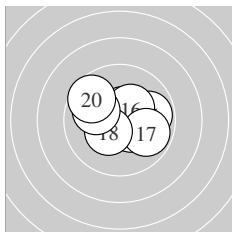

Serie 2:
 10.7 * 10.9 * 10.6 * 10.4 * 9.9 →
 10.3 * 9.9 → 10.4 * 10.0 ← 9.6 ↖
 beste Teiler 6.0 (12.) 63.5 (11.) 95.8 (13.)
 Trefferlage 0.22 mm rechts, 0.21 mm hoch
 Streuwert 1.46, horizontal: 1.78, vertikal: 1.04

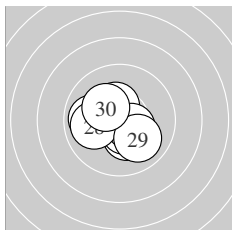

Serie 3:
 10.7 * 10.3 * 9.9 ← 10.4 * 10.4 *
 10.5 * 10.4 * 10.0 ← 10.0 ↘ 10.2 *
 beste Teiler 54.8 (21.) 109.5 (26.) 127.9 (27.)
 Trefferlage 0.37 mm links, 0.25 mm tief
 Streuwert 1.27, horizontal: 1.45, vertikal: 1.06

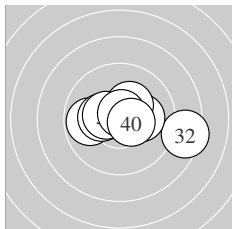

Serie 4:
 9.8 ← 8.4 → 10.6 * 10.5 * 10.2 *
 10.3 * 10.4 * 10.3 * 10.7 * 10.5 *
 beste Teiler 54.7 (39.) 83.2 (33.) 104.7 (34.)
 Trefferlage 0.61 mm rechts, 0.12 mm hoch
 Streuwert 1.80, horizontal: 2.44, vertikal: 0.72

Unterschrift des Schützen

Meyton Elektronik

Ergebnis: **409.1** (391)
 Serien: 100.8 100.2 103.5 104.6
 Zähler: 33 5 2 0 0 0 0 0 0 0
 Innenzehner: 26
 weiteste: 553 (4), 515 (18), 487 (6)
 beste Teiler 5.3 (8.) 7.8 (2.) 18.1 (11.)
 Trefferlage 0.19 mm rechts, 0.08 mm hoch
 Streuwert 1.65, horizontal: 2.18, vertikal: 0.82

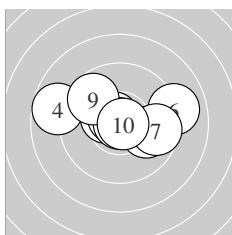
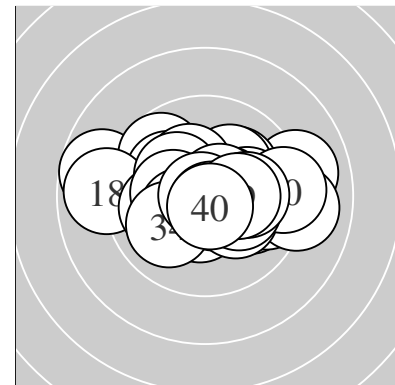

Serie 1:
 10.4 * 10.9 * 10.0 → 8.7 ← 10.7 *
 9.0 → 9.7 → 10.9 * 9.7 ↖ 10.8 *
 beste Teiler 5.3 (8.) 7.8 (2.) 30.8 (10.)
 Trefferlage 0.10 mm rechts, 0.41 mm hoch
 Streuwert 2.12, horizontal: 2.87, vertikal: 0.89

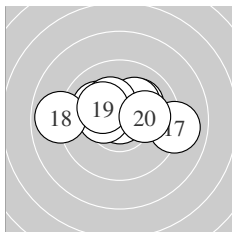

Serie 2:
 10.9 * 10.1 ↖ 10.1 ↗ 10.2 * 10.3 *
 10.4 * 9.0 → 8.9 ← 10.2 * 10.1 →
 beste Teiler 18.1 (11.) 141.0 (16.) 172.2 (15.)
 Trefferlage 0.08 mm links, 0.70 mm hoch
 Streuwert 1.99, horizontal: 2.72, vertikal: 0.72

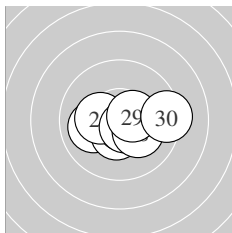

Serie 3:
 10.7 * 10.0 ← 10.5 * 10.7 * 10.7 *
 10.3 * 10.6 * 10.2 * 10.5 * 9.3 →
 beste Teiler 55.0 (24.) 59.4 (21.) 75.8 (25.)
 Trefferlage 0.44 mm rechts, 0.38 mm tief
 Streuwert 1.29, horizontal: 1.75, vertikal: 0.53

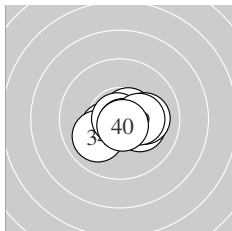

Serie 4:
 10.2 * 10.7 * 10.4 * 10.0 ↙ 10.6 *
 10.9 * 10.1 → 10.7 * 10.3 * 10.7 *
 beste Teiler 20.3 (36.) 56.4 (38.) 60.8 (40.)
 Trefferlage 0.31 mm rechts, 0.37 mm tief
 Streuwert 1.01, horizontal: 1.32, vertikal: 0.55

Unterschrift des Schützen

Meyton Elektronik

Ergebnis: **411.4** (393)
 Serien: 103.5 103.5 100.7 103.7
 Zähler: 33 7 0 0 0 0 0 0 0 0
 Innenzehner: 26
 weiteste: 407 (29), 363 (23), 309 (22)
 beste Teiler 40.3 (12.) 61.4 (15.) 63.6 (6.)
 Trefferlage 0.05 mm links, 0.01 mm hoch
 Streuwert 1.35, horizontal: 1.60, vertikal: 1.05

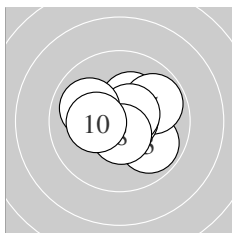
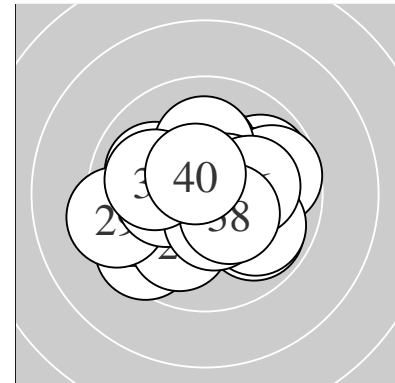

Serie 1:
 10.6 * 10.7 * 9.9 ↘ 10.3 * 9.8 ↗
 10.7 * 10.6 * 10.6 * 10.0 ↖ 10.3 *
 beste Teiler 63.6 (6.) 70.8 (2.) 91.8 (7.)
 Trefferlage 0.33 mm rechts, 0.17 mm hoch
 Streuwert 1.27, horizontal: 1.51, vertikal: 0.98

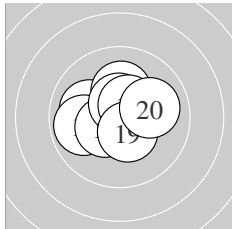

Serie 2:
 10.0 ↖ 10.8 * 9.9 ← 10.2 * 10.7 *
 10.4 * 10.5 * 10.5 * 10.5 * 10.0 →
 beste Teiler 40.3 (12.) 61.4 (15.) 103.2 (17.)
 Trefferlage 0.29 mm links, 0.30 mm hoch
 Streuwert 1.21, horizontal: 1.43, vertikal: 0.93

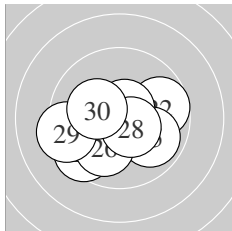

Serie 3:
 10.5 * 9.7 → 9.5 ↙ 10.4 * 9.9 ↘
 10.0 ↙ 10.7 * 10.5 * 9.3 ← 10.2 *
 beste Teiler 73.9 (27.) 107.4 (28.) 115.3 (21.)
 Trefferlage 0.22 mm links, 0.72 mm tief
 Streuwert 1.74, horizontal: 2.17, vertikal: 1.16

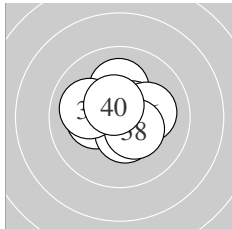

Serie 4:
 10.1 ↑ 10.6 * 10.5 * 10.6 * 10.3 *
 10.1 → 10.5 * 10.4 * 10.0 ↖ 10.6 *
 beste Teiler 86.8 (32.) 98.8 (40.) 99.7 (34.)
 Trefferlage 0.03 mm links, 0.28 mm hoch
 Streuwert 1.15, horizontal: 1.35, vertikal: 0.91

Unterschrift des Schützen

Meyton Elektronik

Ergebnis: **408.6** (389)
 Serien: 101.2 101.0 104.2 102.2
 Zähler: 29 11 0 0 0 0 0 0 0 0
 Innenzehner: 24
 weiteste: 407 (17), 405 (20), 404 (9)
 beste Teiler 27.6 (12.) 50.6 (28.) 56.4 (27.)
 Trefferlage 0.58 mm links, 0.22 mm tief
 Streuwert 1.43, horizontal: 1.82, vertikal: 0.90

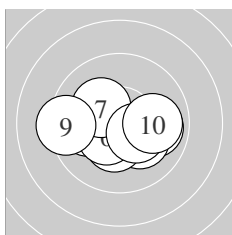
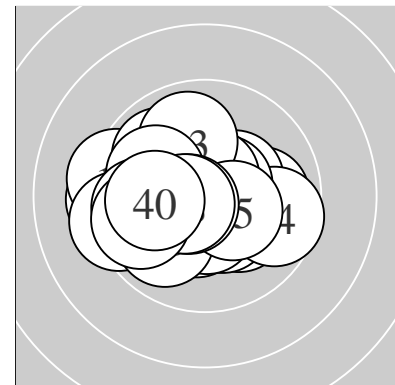

Serie 1:
 10.4 * 9.9 → 10.2 * 10.0 ← 10.4 *
 10.4 * 10.2 * 10.4 * 9.3 ← 10.0 →
 beste Teiler 132.3 (6.) 132.8 (1.) 144.9 (8.)
 Trefferlage 0.02 mm links, 0.46 mm tief
 Streuwert 1.62, horizontal: 2.18, vertikal: 0.73

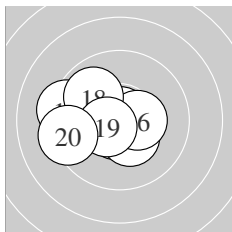

Serie 2:
 10.6 * 10.8 * 10.4 * 9.7 ← 10.1 ←
 10.4 * 9.3 ← 9.9 ↘ 10.5 * 9.3 ←
 beste Teiler 27.6 (12.) 78.1 (11.) 106.9 (19.)
 Trefferlage 1.41 mm links, 0.04 mm tief
 Streuwert 1.50, horizontal: 1.91, vertikal: 0.91

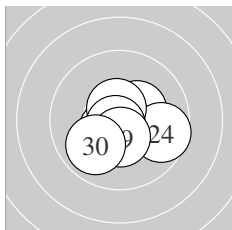

Serie 3:
 10.4 * 10.5 * 10.6 * 9.6 → 10.7 *
 10.6 * 10.7 * 10.8 * 10.4 * 9.9 ↙
 beste Teiler 50.6 (28.) 56.4 (27.) 68.4 (25.)
 Trefferlage 0.13 mm rechts, 0.53 mm tief
 Streuwert 1.11, horizontal: 1.33, vertikal: 0.82

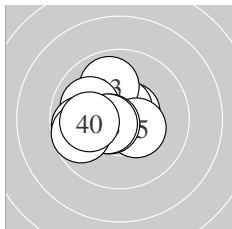

Serie 4:
 10.6 * 10.6 * 9.9 ↑ 10.0 ↘ 10.4 *
 10.6 * 9.8 ← 10.6 * 9.7 ← 10.0 ←
 beste Teiler 81.8 (36.) 84.6 (32.) 94.3 (31.)
 Trefferlage 1.04 mm links, 0.15 mm hoch
 Streuwert 1.29, horizontal: 1.50, vertikal: 1.04

Unterschrift des Schützen

Meyton Elektronik