

Ergebnis: **405.9** (387)  
 Serien: 102.2 102.0 100.8 100.9  
 Zaehler: 27 13 0 0 0 0 0 0 0 0  
 Innenzehner: 19  
 weiteste: 397 (22), 372 (14), 306 (37)  
 beste Teiler 33.0 (13.) 35.5 (7.) 58.8 (30.)  
 Trefferlage 0.57 mm links, 0.17 mm tief  
 Streuwert 1.49, horizontal: 1.57, vertikal: 1.41

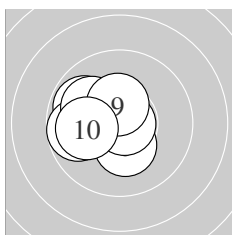

Serie 1:  
 10.6 \*                      9.8 ↖                      10.5 \*                      9.7 ←                      10.1 ←  
 10.3 \*                      10.8 \*                      10.0 ↖                      10.4 \*                      10.0 ←  
 beste Teiler 35.5 (7.) 88.6 (1.) 112.7 (3.)  
 Trefferlage 1.27 mm links, 0.20 mm hoch  
 Streuwert 1.10, horizontal: 1.26, vertikal: 0.92

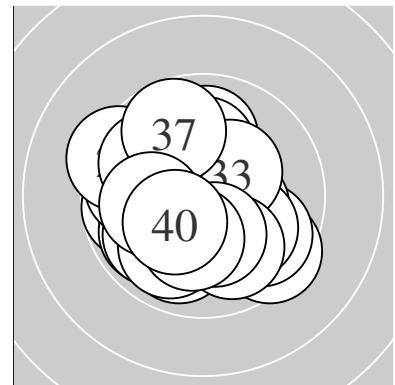
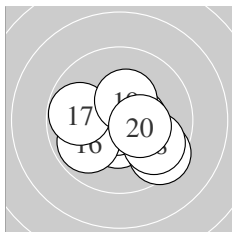

Serie 2:  
 10.5 \*                      10.5 \*                      10.8 \*                      9.5 ↘                      10.5 \*  
 9.9 ↙                      9.8 ←                      9.8 ↘                      10.4 \*                      10.3 \*  
 beste Teiler 33.0 (13.) 112.2 (15.) 120.5 (12.)  
 Trefferlage 0.39 mm rechts, 0.62 mm tief  
 Streuwert 1.52, horizontal: 1.84, vertikal: 1.12

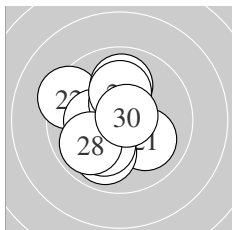

Serie 3:  
 10.0 ↘                      9.4 ↖                      9.9 ↙                      10.1 ↙                      10.2 \*  
 10.5 \*                      10.0 ↑                      9.9 ↙                      10.1 ↑                      10.7 \*  
 beste Teiler 58.8 (30.) 120.0 (26.) 177.0 (25.)  
 Trefferlage 0.70 mm links, 0.04 mm hoch  
 Streuwert 1.65, horizontal: 1.55, vertikal: 1.76

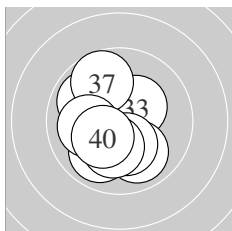

Serie 4:  
 10.3 \*                      9.9 ↙                      10.3 \*                      9.9 ↖                      9.9 ↘  
 10.3 \*                      9.7 ↖                      10.2 \*                      10.1 ←                      10.3 \*  
 beste Teiler 152.8 (31.) 155.1 (33.) 165.5 (40.)  
 Trefferlage 0.72 mm links, 0.33 mm tief  
 Streuwert 1.53, horizontal: 1.29, vertikal: 1.74

Unterschrift des Schuetzen

Meyton Elektronik

Ergebnis: **407.8** (386)  
 Serien: 104.1 102.7 99.8 101.2  
 Zaehler: 27 12 1 0 0 0 0 0 0 0  
 Innenzehner: 23  
 weiteste: 576 (27), 457 (22), 351 (35)  
 beste Teiler 29.0 (9.) 38.4 (6.) 40.0 (1.)  
 Trefferlage 0.18 mm links, 0.06 mm tief  
 Streuwert 1.61, horizontal: 1.88, vertikal: 1.27

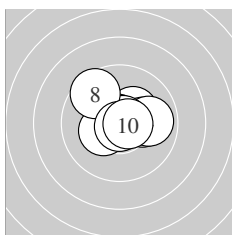
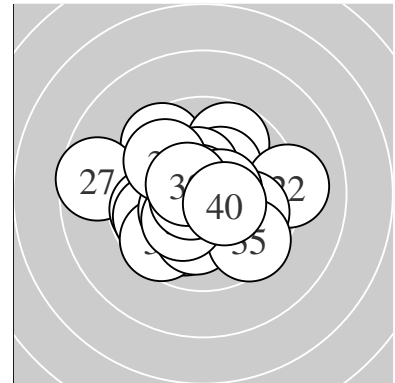

Serie 1:  
 10.8 \*                      10.3 \*                      10.1 →                      9.9 →                      10.8 \*  
 10.8 \*                      10.3 \*                      9.6 ↖                      10.8 \*                      10.7 \*  
 beste Teiler 29.0 (9.) 38.4 (6.) 40.0 (1.)  
 Trefferlage 0.34 mm rechts, 0.35 mm hoch  
 Streuwert 1.22, horizontal: 1.46, vertikal: 0.92

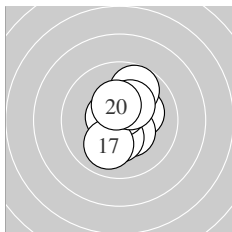

Serie 2:  
 10.2 \*                      10.4 \*                      10.6 \*                      10.3 \*                      10.6 \*  
 10.1 ↗                      10.0 ↘                      9.8 ↗                      10.3 \*                      10.4 \*  
 beste Teiler 78.4 (15.) 88.5 (13.) 139.2 (20.)  
 Trefferlage 0.39 mm rechts, 0.43 mm hoch  
 Streuwert 1.30, horizontal: 0.94, vertikal: 1.58

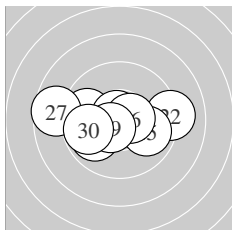

Serie 3:  
 10.8 \*                      9.1 →                      9.8 ←                      10.8 \*                      9.9 →  
 10.6 \*                      8.6 ←                      9.9 ↙                      10.5 \*                      9.8 ←  
 beste Teiler 47.8 (21.) 50.4 (24.) 96.3 (26.)  
 Trefferlage 0.72 mm links, 0.17 mm tief  
 Streuwert 2.14, horizontal: 2.93, vertikal: 0.77

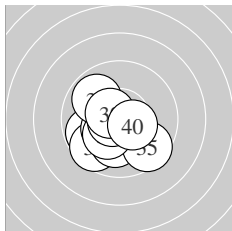

Serie 4:  
 9.8 ↙                      9.6 ↙                      10.3 \*                      10.1 ↓                      9.5 ↘  
 10.3 \*                      9.9 ↘                      10.7 \*                      10.6 \*                      10.4 \*  
 beste Teiler 68.6 (38.) 99.6 (39.) 127.5 (40.)  
 Trefferlage 0.75 mm links, 0.89 mm tief  
 Streuwert 1.47, horizontal: 1.57, vertikal: 1.36

Unterschrift des Schuetzen

Meyton Elektronik

Ergebnis: **403.8** (387)  
 Serien: 101.0 100.9 101.0 100.9  
 Zaehler: 27 13 0 0 0 0 0 0 0 0  
 Innenzehner: 18  
 weiteste: 496 (10), 427 (37), 410 (21)  
 beste Teiler 37.6 (32.) 55.6 (6.) 56.0 (4.)  
 Trefferlage 0.11 mm links, 0.36 mm tief  
 Streuwert 1.69, horizontal: 1.82, vertikal: 1.56

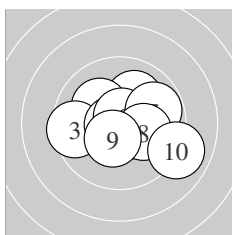
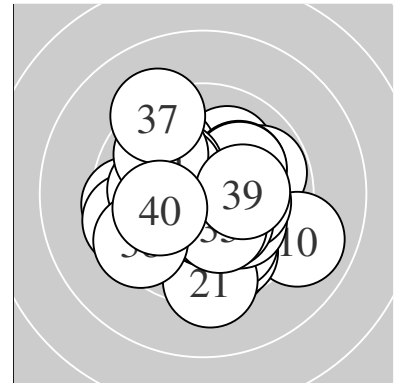

Serie 1:  
 10.1 ↗ 10.1 ↘ 9.5 ← 10.7 \* 10.6 \*  
 10.7 \* 9.8 → 10.1 → 10.4 \* 9.0 ↘  
 beste Teiler 55.6 (6.) 56.0 (4.) 98.6 (5.)  
 Trefferlage 0.49 mm rechts, 0.04 mm tief  
 Streuwert 1.82, horizontal: 2.26, vertikal: 1.24

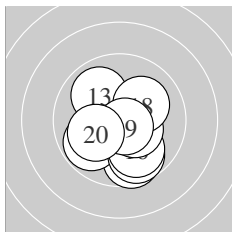

Serie 2:  
 9.6 ↓ 10.7 \* 9.9 ↘ 9.8 ↙ 9.7 ↓  
 9.9 ↓ 10.4 \* 10.1 ↗ 10.7 \* 10.1 ←  
 beste Teiler 57.0 (12.) 65.2 (19.) 140.8 (17.)  
 Trefferlage 0.06 mm rechts, 0.91 mm tief  
 Streuwert 1.57, horizontal: 1.49, vertikal: 1.65

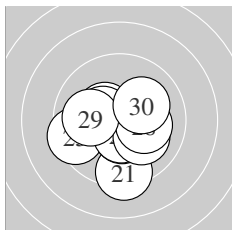

Serie 3:  
 9.3 ↓ 10.4 \* 10.4 \* 10.5 \* 9.5 ←  
 10.5 \* 10.1 ↘ 10.2 \* 10.0 ← 10.1 →  
 beste Teiler 114.8 (26.) 121.6 (24.) 137.5 (22.)  
 Trefferlage 0.21 mm links, 0.68 mm tief  
 Streuwert 1.67, horizontal: 1.82, vertikal: 1.50

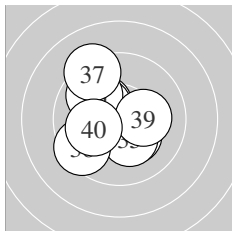

Serie 4:  
 10.3 \* 10.8 \* 10.3 \* 10.3 \* 10.3 \*  
 9.9 ↘ 9.2 ↘ 9.5 ↙ 10.2 \* 10.1 ←  
 beste Teiler 37.6 (32.) 164.2 (34.) 168.7 (33.)  
 Trefferlage 0.78 mm links, 0.18 mm hoch  
 Streuwert 1.71, horizontal: 1.64, vertikal: 1.78

Unterschrift des Schuetzen

Meyton Elektronik

Ergebnis: **409.0** (392)  
 Serien: 101.3 103.7 102.7 101.3  
 Zaehler: 32 8 0 0 0 0 0 0 0 0  
 Innenzehner: 26  
 weiteste: 397 (31), 330 (33), 312 (4)  
 beste Teiler 16.1 (32.) 29.5 (22.) 41.2 (12.)  
 Trefferlage 0.41 mm links, 0.06 mm hoch  
 Streuwert 1.41, horizontal: 1.62, vertikal: 1.16

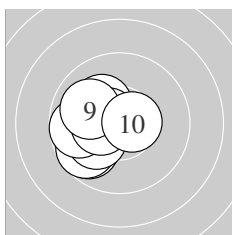
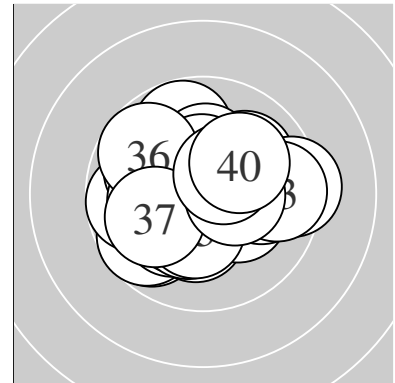

Serie 1:  
 9.8 ↙ 10.2 \* 10.2 \* 9.7 ↙ 10.1 ↙  
 9.7 ← 10.6 \* 10.4 \* 10.0 ↘ 10.6 \*  
 beste Teiler 92.4 (10.) 98.4 (7.) 139.7 (8.)  
 Trefferlage 1.63 mm links, 0.23 mm tief  
 Streuwert 1.11, horizontal: 1.09, vertikal: 1.12

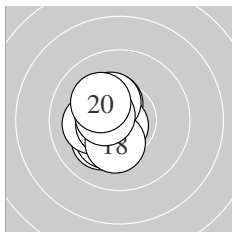

Serie 2:  
 10.4 \* 10.8 \* 10.2 \* 10.3 \* 10.1 ←  
 10.5 \* 10.4 \* 10.3 \* 10.5 \* 10.2 \*  
 beste Teiler 41.2 (12.) 108.7 (16.) 114.1 (19.)  
 Trefferlage 0.95 mm links, 0.13 mm tief  
 Streuwert 0.92, horizontal: 0.58, vertikal: 1.16

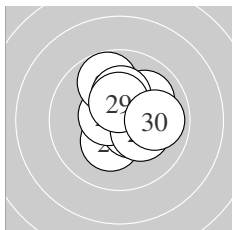

Serie 3:  
 10.0 ↗ 10.8 \* 10.3 \* 10.5 \* 10.6 \*  
 9.8 ↑ 10.2 \* 10.2 \* 10.4 \* 9.9 →  
 beste Teiler 29.5 (22.) 91.0 (25.) 104.5 (24.)  
 Trefferlage 0.43 mm rechts, 0.45 mm hoch  
 Streuwert 1.30, horizontal: 1.23, vertikal: 1.36

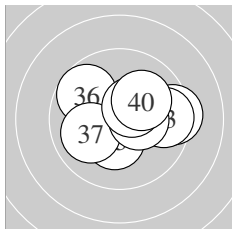

Serie 4:  
 9.4 → 10.9 \* 9.6 → 10.5 \* 10.3 \*  
 9.7 ↘ 10.0 ← 10.4 \* 10.4 \* 10.1 ↗  
 beste Teiler 16.1 (32.) 115.5 (34.) 128.0 (39.)  
 Trefferlage 0.50 mm rechts, 0.15 mm hoch  
 Streuwert 1.68, horizontal: 2.15, vertikal: 1.02

Unterschrift des Schuetzen

Meyton Elektronik