

Ergebnis: **414.3** (396)  
 Serien: 101.9 104.6 104.5 103.3  
 Zähler: 36 4 0 0 0 0 0 0 0 0  
 Innenzehner: 31  
 weiteste: 286 (30), 283 (1), 277 (4)  
 beste Teiler 25.9 (29.) 37.8 (28.) 39.8 (17.)  
 Trefferlage 0.17 mm rechts, 0.05 mm hoch  
 Streuwert 1.18, horizontal: 1.22, vertikal: 1.13

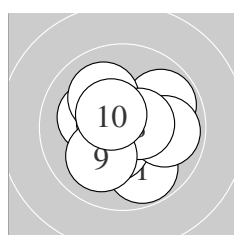

Serie 1:  
 9.8 ↘                      10.2 \*                      10.7 \*                      9.8 ↗                      10.4 \*  
 9.9 →                      10.1 ↖                      10.5 \*                      10.0 ↙                      10.5 \*  
 beste Teiler 72.9 (3.) 105.1 (8.) 107.6 (10.)  
 Trefferlage 0.09 mm rechts, 0.05 mm tief  
 Streuwert 1.51, horizontal: 1.61, vertikal: 1.41

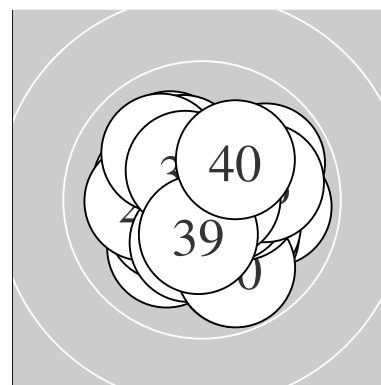
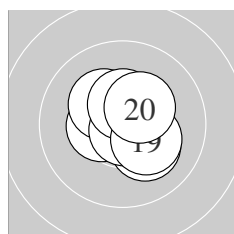

Serie 2:  
 10.6 \*                      10.2 \*                      10.4 \*                      10.7 \*                      10.5 \*  
 10.3 \*                      10.8 \*                      10.5 \*                      10.2 \*                      10.4 \*  
 beste Teiler 39.8 (17.) 73.2 (14.) 97.6 (11.)  
 Trefferlage 0.26 mm rechts, 0.18 mm hoch  
 Streuwert 0.98, horizontal: 1.03, vertikal: 0.93

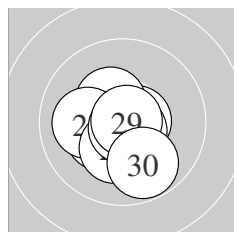

Serie 3:  
 10.3 \*                      10.7 \*                      10.6 \*                      10.4 \*                      10.1 ←  
 10.6 \*                      10.3 \*                      10.8 \*                      10.9 \*                      9.8 ↘  
 beste Teiler 25.9 (29.) 37.8 (28.) 51.0 (22.)  
 Trefferlage 0.14 mm links, 0.49 mm tief  
 Streuwert 1.04, horizontal: 1.06, vertikal: 1.03

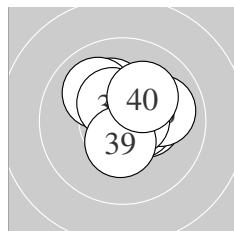

Serie 4:  
 10.2 \*                      10.4 \*                      10.5 \*                      10.5 \*                      10.0 ↖  
 10.0 →                      10.7 \*                      10.4 \*                      10.4 \*                      10.2 \*  
 beste Teiler 72.3 (37.) 102.3 (33.) 108.6 (34.)  
 Trefferlage 0.47 mm rechts, 0.59 mm hoch  
 Streuwert 1.09, horizontal: 1.20, vertikal: 0.98

Unterschrift des Schützen

Meyton Elektronik

Ergebnis: **409.2** (387)  
 Serien: 100.4 103.6 103.9 101.3  
 Zähler: 28 11 1 0 0 0 0 0 0 0  
 Innenzehner: 26  
 weiteste: 507 (37), 429 (10), 353 (5)  
 beste Teiler 43.6 (30.) 45.8 (13.) 47.8 (36.)  
 Trefferlage 0.22 mm links, 0.23 mm tief  
 Streuwert 1.52, horizontal: 1.90, vertikal: 1.01

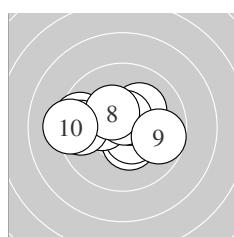
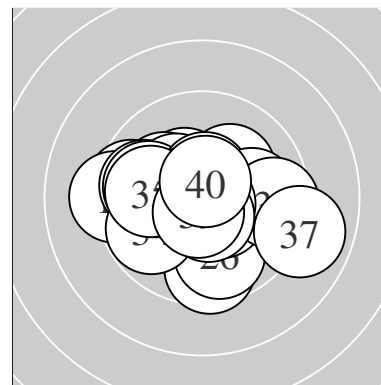

Serie 1:  
 10.4 \*                      10.5 \*                      10.3 \*                      10.2 \*                      9.5 ←  
 9.6 ←                      10.6 \*                      10.4 \*                      9.7 →                      9.2 ←  
 beste Teiler 79.8 (7.) 106.0 (2.) 138.0 (1.)  
 Trefferlage 0.79 mm links, 0.15 mm hoch  
 Streuwert 1.79, horizontal: 2.38, vertikal: 0.88

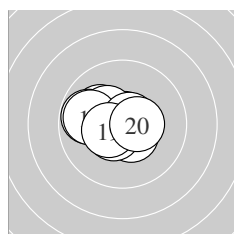

Serie 2:  
 10.1 ↖                      9.8 ←                      10.8 \*                      10.5 \*                      10.3 \*  
 10.5 \*                      9.9 ←                      10.7 \*                      10.5 \*                      10.5 \*  
 beste Teiler 45.8 (13.) 65.7 (18.) 105.3 (16.)  
 Trefferlage 0.78 mm links, 0.17 mm hoch  
 Streuwert 1.10, horizontal: 1.40, vertikal: 0.68

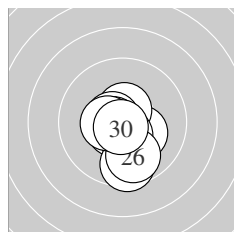

Serie 3:  
 10.3 \*                      10.6 \*                      10.6 \*                      10.5 \*                      9.6 ↓  
 9.8 ↓                      10.6 \*                      10.6 \*                      10.5 \*                      10.8 \*  
 beste Teiler 43.6 (30.) 79.6 (28.) 87.6 (27.)  
 Trefferlage 0.06 mm links, 0.81 mm tief  
 Streuwert 1.12, horizontal: 0.84, vertikal: 1.34

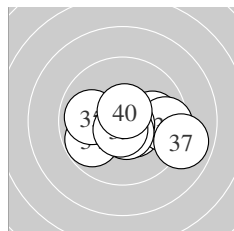

Serie 4:  
 10.0 →                      10.5 \*                      9.5 →                      9.8 ↙                      9.9 ←  
 10.8 \*                      8.9 →                      10.6 \*                      10.7 \*                      10.6 \*  
 beste Teiler 47.8 (36.) 72.2 (39.) 82.5 (40.)  
 Trefferlage 0.73 mm rechts, 0.46 mm tief  
 Streuwert 1.75, horizontal: 2.35, vertikal: 0.79

Unterschrift des Schützen

Meyton Elektronik

Ergebnis: **415.6** (397)  
 Serien: 103.7 104.4 104.0 103.5  
 Zähler: 37 3 0 0 0 0 0 0 0 0  
 Innenzehner: 32  
 weiteste: 291 (16), 274 (10), 253 (9)  
 beste Teiler 12.5 (18.) 23.3 (40.) 50.0 (26.)  
 Trefferlage 0.01 mm links, 0.09 mm tief  
 Streuwert 1.13, horizontal: 1.33, vertikal: 0.87

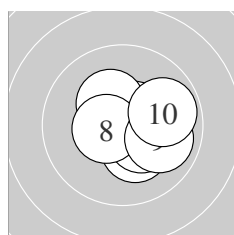
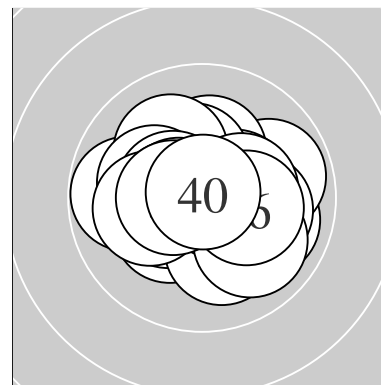

Serie 1:  
 10.7 \*                      10.5 \*                      10.6 \*                      10.3 \*                      10.6 \*  
 10.3 \*                      10.4 \*                      10.5 \*                      9.9 →                      9.9 →  
 beste Teiler 71.5 (1.) 91.4 (3.) 96.5 (5.)  
 Trefferlage 0.80 mm rechts, 0.24 mm tief  
 Streuwert 1.04, horizontal: 1.16, vertikal: 0.91

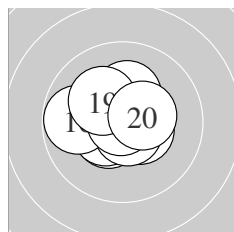

Serie 2:  
 10.5 \*                      10.7 \*                      10.5 \*                      10.5 \*                      10.7 \*  
 9.8 ←                      10.2 \*                      10.9 \*                      10.2 \*                      10.4 \*  
 beste Teiler 12.5 (18.) 64.5 (12.) 70.3 (15.)  
 Trefferlage 0.38 mm links, 0.14 mm hoch  
 Streuwert 1.08, horizontal: 1.26, vertikal: 0.86

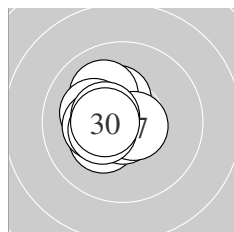

Serie 3:  
 10.3 \*                      10.1 ↖                      10.2 \*                      10.3 \*                      10.3 \*  
 10.8 \*                      10.6 \*                      10.4 \*                      10.5 \*                      10.5 \*  
 beste Teiler 50.0 (26.) 76.2 (27.) 115.0 (30.)  
 Trefferlage 0.92 mm links, 0.16 mm hoch  
 Streuwert 0.86, horizontal: 0.81, vertikal: 0.91

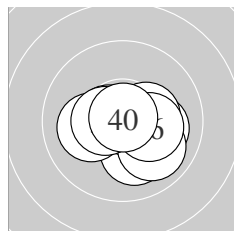

Serie 4:  
 10.1 ↘                      10.1 →                      10.7 \*                      10.0 ↘                      10.3 \*  
 10.2 \*                      10.1 ←                      10.6 \*                      10.5 \*                      10.9 \*  
 beste Teiler 23.3 (40.) 61.1 (33.) 91.6 (38.)  
 Trefferlage 0.45 mm rechts, 0.43 mm tief  
 Streuwert 1.15, horizontal: 1.43, vertikal: 0.77

Unterschrift des Schützen

Meyton Elektronik

Ergebnis: **422.3** (400)  
 Serien: 105.9 105.2 106.8 104.4  
 Zähler: 40 0 0 0 0 0 0 0 0 0  
 Innenzehner: 38  
 weiteste: 239 (9), 227 (39), 188 (30)  
 beste Teiler 5.0 (22.) 25.0 (1.) 29.8 (18.)  
 Trefferlage 0.08 mm links, 0.01 mm tief  
 Streuwert 0.82, horizontal: 0.98, vertikal: 0.62

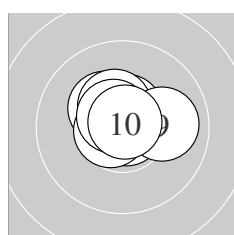
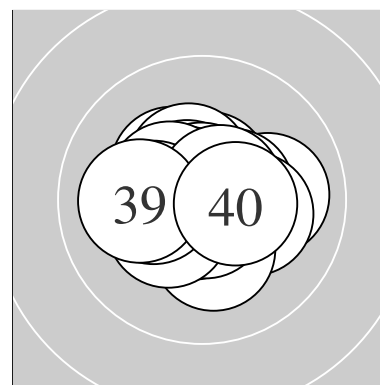

Serie 1:  
 10.9 \*                      10.6 \*                      10.8 \*                      10.8 \*                      10.3 \*  
 10.7 \*                      10.4 \*                      10.6 \*                      10.0 →                      10.8 \*  
 beste Teiler 25.0 (1.) 31.9 (4.) 34.0 (10.)  
 Trefferlage 0.00 mm , 0.48 mm hoch  
 Streuwert 0.77, horizontal: 0.95, vertikal: 0.51

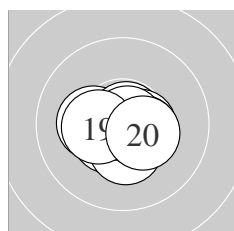

Serie 2:  
 10.2 \*                      10.8 \*                      10.8 \*                      10.5 \*                      10.4 \*  
 10.5 \*                      10.4 \*                      10.8 \*                      10.4 \*                      10.4 \*  
 beste Teiler 29.8 (18.) 39.6 (13.) 49.6 (12.)  
 Trefferlage 0.04 mm links, 0.31 mm tief  
 Streuwert 0.84, horizontal: 1.07, vertikal: 0.51

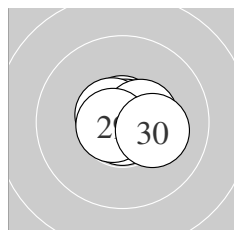

Serie 3:  
 10.7 \*                      10.9 \*                      10.8 \*                      10.8 \*                      10.8 \*  
 10.6 \*                      10.8 \*                      10.5 \*                      10.7 \*                      10.2 \*  
 beste Teiler 5.0 (22.) 33.6 (25.) 38.0 (27.)  
 Trefferlage 0.16 mm rechts, 0.04 mm hoch  
 Streuwert 0.60, horizontal: 0.76, vertikal: 0.37

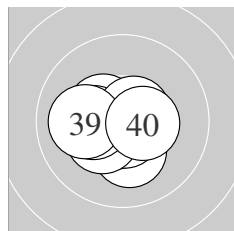

Serie 4:  
 10.2 \*                      10.8 \*                      10.7 \*                      10.7 \*                      10.4 \*  
 10.3 \*                      10.2 \*                      10.6 \*                      10.0 ←                      10.5 \*  
 beste Teiler 38.2 (32.) 62.1 (34.) 74.7 (33.)  
 Trefferlage 0.46 mm links, 0.29 mm tief  
 Streuwert 0.95, horizontal: 1.12, vertikal: 0.73

Unterschrift des Schützen

Meyton Elektronik

Ergebnis: **418.3** (397)  
 Serien: 104.5 105.3 103.6 104.9  
 Zähler: 37 3 0 0 0 0 0 0 0 0  
 Innenzehner: 37  
 weiteste: 322 (29), 305 (26), 260 (22)  
 beste Teiler 1.0 (28.) 14.0 (11.) 45.6 (2.)  
 Trefferlage 0.10 mm rechts, 0.01 mm tief  
 Streuwert 1.00, horizontal: 1.19, vertikal: 0.77

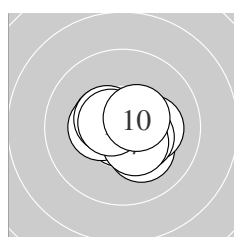
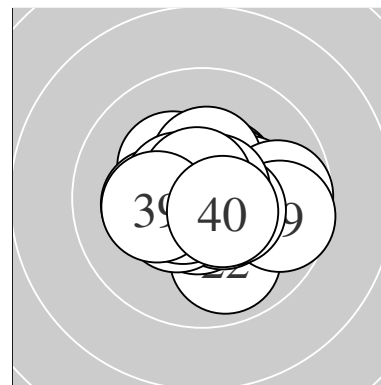

Serie 1:  
 10.2 \*                      10.8 \*                      10.5 \*                      10.4 \*                      10.2 \*  
 10.4 \*                      10.4 \*                      10.5 \*                      10.6 \*                      10.5 \*  
 beste Teiler 45.6 (2.) 83.0 (9.) 112.6 (10.)  
 Trefferlage 0.15 mm rechts, 0.16 mm tief  
 Streuwert 0.99, horizontal: 1.21, vertikal: 0.71

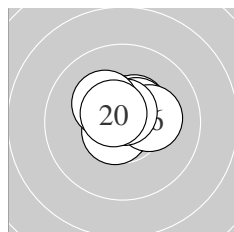

Serie 2:  
 10.9 \*                      10.6 \*                      10.5 \*                      10.5 \*                      10.6 \*  
 10.2 \*                      10.4 \*                      10.7 \*                      10.3 \*                      10.6 \*  
 beste Teiler 14.0 (11.) 68.4 (18.) 79.5 (15.)  
 Trefferlage 0.02 mm rechts, 0.56 mm hoch  
 Streuwert 0.76, horizontal: 0.91, vertikal: 0.57

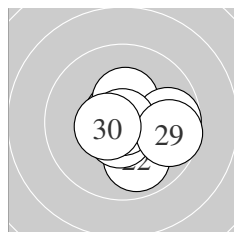

Serie 3:  
 10.6 \*                      9.9 ↘                      10.6 \*                      10.7 \*                      10.4 \*  
 9.7 →                      10.6 \*                      10.9 \*                      9.7 →                      10.5 \*  
 beste Teiler 1.0 (28.) 56.6 (24.) 76.4 (21.)  
 Trefferlage 0.59 mm rechts, 0.25 mm tief  
 Streuwert 1.24, horizontal: 1.45, vertikal: 1.00

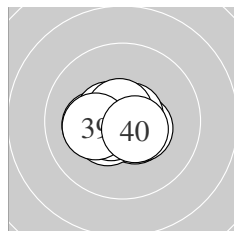

Serie 4:  
 10.5 \*                      10.5 \*                      10.4 \*                      10.2 \*                      10.6 \*  
 10.5 \*                      10.7 \*                      10.7 \*                      10.2 \*                      10.6 \*  
 beste Teiler 60.4 (37.) 64.5 (38.) 87.7 (35.)  
 Trefferlage 0.32 mm links, 0.21 mm tief  
 Streuwert 0.86, horizontal: 1.11, vertikal: 0.48

Unterschrift des Schützen

Meyton Elektronik

Ergebnis: **412.7** (394)  
 Serien: 105.3 101.8 102.3 103.3  
 Zähler: 34 6 0 0 0 0 0 0 0 0  
 Innenzehner: 30  
 weiteste: 414 (13), 370 (30), 311 (12)  
 beste Teiler 22.0 (39.) 56.7 (19.) 60.8 (5.)  
 Trefferlage 0.27 mm rechts, 0.08 mm hoch  
 Streuwert 1.28, horizontal: 1.64, vertikal: 0.76

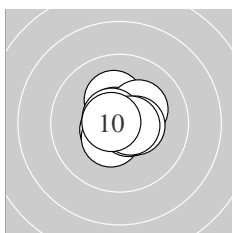
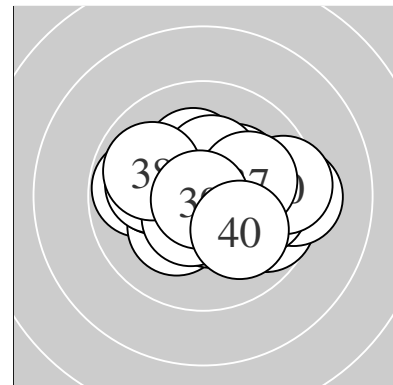

Serie 1:  
 10.6 \*                      10.4 \*                      10.2 \*                      10.7 \*                      10.7 \*  
 10.2 \*                      10.5 \*                      10.7 \*                      10.6 \*                      10.7 \*  
 beste Teiler 60.8 (5.) 63.6 (10.) 73.2 (8.)  
 Trefferlage 0.06 mm rechts, 0.15 mm hoch  
 Streuwert 0.84, horizontal: 0.87, vertikal: 0.82

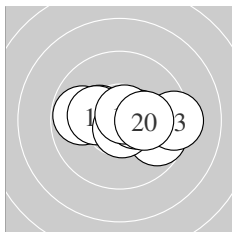

Serie 2:  
 9.8 ←                      9.7 ↘                      9.3 →                      10.3 \*                      10.2 \*  
 10.7 \*                      10.4 \*                      10.5 \*                      10.7 \*                      10.2 \*  
 beste Teiler 56.7 (19.) 64.8 (16.) 122.1 (18.)  
 Trefferlage 0.58 mm rechts, 0.02 mm tief  
 Streuwert 1.58, horizontal: 2.17, vertikal: 0.53

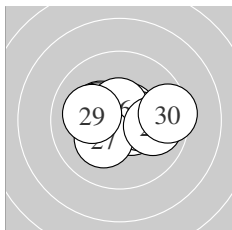

Serie 3:  
 10.6 \*                      10.3 \*                      10.6 \*                      10.2 \*                      10.3 \*  
 10.6 \*                      10.2 \*                      9.9 →                      10.1 ←                      9.5 →  
 beste Teiler 84.8 (21.) 97.3 (26.) 99.2 (23.)  
 Trefferlage 0.27 mm rechts, 0.14 mm hoch  
 Streuwert 1.46, horizontal: 1.93, vertikal: 0.73

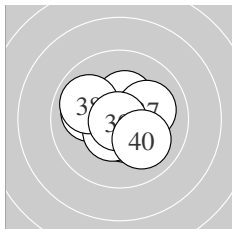

Serie 4:  
 10.5 \*                      10.4 \*                      10.0 ←                      10.5 \*                      10.5 \*  
 10.5 \*                      10.1 →                      9.9 ←                      10.9 \*                      10.0 ↘  
 beste Teiler 22.0 (39.) 110.7 (34.) 111.1 (35.)  
 Trefferlage 0.15 mm rechts, 0.07 mm hoch  
 Streuwert 1.27, horizontal: 1.50, vertikal: 0.99

Unterschrift des Schützen

Ergebnis: **419.3** (398)  
 Serien: 104.2 104.3 104.9 105.9  
 Zähler: 38 2 0 0 0 0 0 0 0 0  
 Innenzehner: 37  
 weiteste: 262 (26), 256 (6), 243 (40)  
 beste Teiler 10.4 (38.) 27.3 (35.) 28.1 (27.)  
 Trefferlage 0.05 mm links, 0.00 mm  
 Streuwert 0.95, horizontal: 1.00, vertikal: 0.89

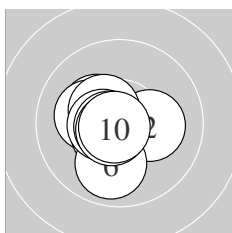
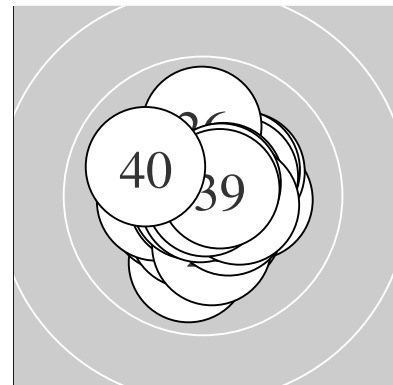

Serie 1:  
 10.3 \*                      10.2 \*                      10.2 \*                      10.4 \*                      10.5 \*  
 9.9 ↓                      10.5 \*                      10.7 \*                      10.7 \*                      10.8 \*  
 beste Teiler 41.4 (10.) 66.0 (9.) 67.0 (8.)  
 Trefferlage 0.62 mm links, 0.22 mm tief  
 Streuwert 0.97, horizontal: 1.00, vertikal: 0.95

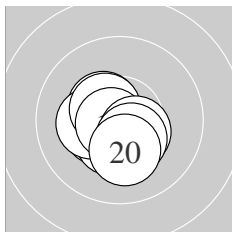

Serie 2:  
 10.4 \*                      10.4 \*                      10.6 \*                      10.4 \*                      10.2 \*  
 10.5 \*                      10.7 \*                      10.5 \*                      10.4 \*                      10.2 \*  
 beste Teiler 57.0 (17.) 78.7 (13.) 114.8 (16.)  
 Trefferlage 0.37 mm links, 0.52 mm tief  
 Streuwert 0.87, horizontal: 0.91, vertikal: 0.84

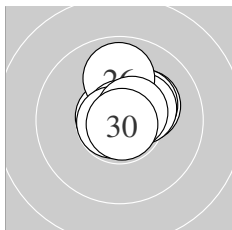

Serie 3:  
 10.5 \*                      10.2 \*                      10.3 \*                      10.7 \*                      10.3 \*  
 9.9 ↑                      10.8 \*                      10.8 \*                      10.6 \*                      10.8 \*  
 beste Teiler 28.1 (27.) 30.0 (30.) 47.1 (28.)  
 Trefferlage 0.43 mm rechts, 0.70 mm hoch  
 Streuwert 0.80, horizontal: 0.78, vertikal: 0.83

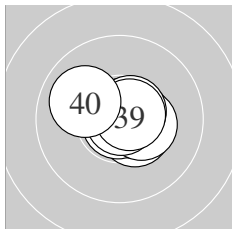

Serie 4:  
 10.8 \*                      10.6 \*                      10.5 \*                      10.6 \*                      10.8 \*  
 10.4 \*                      10.6 \*                      10.9 \*                      10.7 \*                      10.0 ↖  
 beste Teiler 10.4 (38.) 27.3 (35.) 50.9 (31.)  
 Trefferlage 0.36 mm rechts, 0.07 mm hoch  
 Streuwert 0.79, horizontal: 0.99, vertikal: 0.52

Unterschrift des Schützen

Meyton Elektronik

Ergebnis: **418.5** (397)  
 Serien: 105.0 104.2 104.3 105.0  
 Zähler: 37 3 0 0 0 0 0 0 0 0  
 Innenzehner: 35  
 weiteste: 356 (12), 274 (30), 263 (22)  
 beste Teiler 18.1 (34.) 31.5 (9.) 37.4 (6.)  
 Trefferlage 0.07 mm rechts, 0.10 mm hoch  
 Streuwert 1.02, horizontal: 1.24, vertikal: 0.73

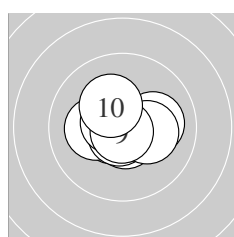
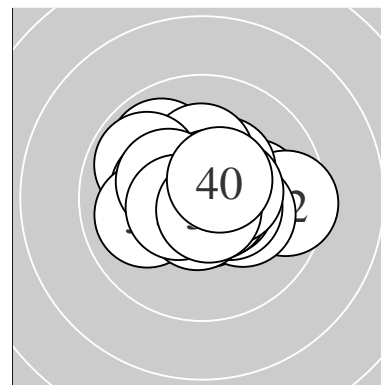

Serie 1:  
 10.7 \*                      10.6 \*                      10.1 →                      10.2 \*                      10.7 \*  
 10.8 \*                      10.2 \*                      10.6 \*                      10.8 \*                      10.3 \*  
 beste Teiler 31.5 (9.) 37.4 (6.) 56.3 (5.)  
 Trefferlage 0.01 mm links, 0.04 mm tief  
 Streuwert 0.97, horizontal: 1.21, vertikal: 0.64

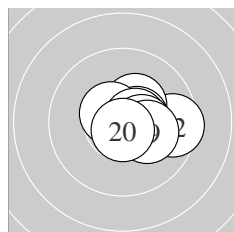

Serie 2:  
 10.8 \*                      9.5 →                      10.6 \*                      10.4 \*                      10.5 \*  
 10.5 \*                      10.6 \*                      10.4 \*                      10.2 \*                      10.7 \*  
 beste Teiler 46.8 (11.) 56.0 (20.) 90.4 (17.)  
 Trefferlage 0.95 mm rechts, 0.12 mm hoch  
 Streuwert 0.93, horizontal: 1.16, vertikal: 0.62

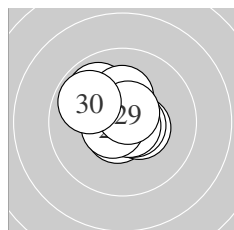

Serie 3:  
 10.6 \*                      9.9 ↖                      10.5 \*                      10.6 \*                      10.7 \*  
 10.7 \*                      10.2 \*                      10.6 \*                      10.6 \*                      9.9 ↖  
 beste Teiler 53.7 (25.) 54.1 (26.) 76.9 (21.)  
 Trefferlage 0.28 mm links, 0.41 mm hoch  
 Streuwert 1.05, horizontal: 1.11, vertikal: 0.99

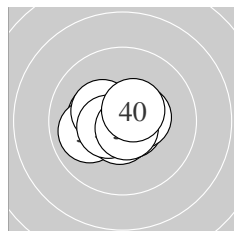

Serie 4:  
 10.3 \*                      10.0 ←                      10.3 \*                      10.9 \*                      10.7 \*  
 10.6 \*                      10.5 \*                      10.5 \*                      10.7 \*                      10.5 \*  
 beste Teiler 18.1 (34.) 58.6 (39.) 71.0 (35.)  
 Trefferlage 0.37 mm links, 0.09 mm tief  
 Streuwert 0.92, horizontal: 1.17, vertikal: 0.58

Unterschrift des Schützen

Meyton Elektronik



Ergebnis: **405.6** (385)  
 Serien: 99.3 101.3 102.9 102.1  
 Zähler: 27 11 2 0 0 0 0 0 0 0  
 Innenzehner: 24  
 weiteste: 563 (8), 560 (13), 475 (31)  
 beste Teiler 54.7 (30.) 64.1 (25.) 66.0 (20.)  
 Trefferlage 0.17 mm rechts, 0.06 mm tief  
 Streuwert 1.71, horizontal: 2.15, vertikal: 1.12

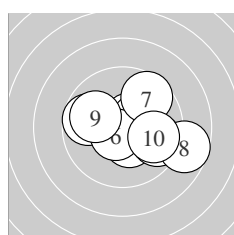
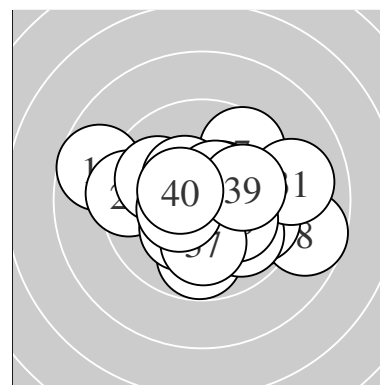

Serie 1:  
 10.6 \*                      10.4 \*                      9.7 ←                      10.3 \*                      9.7 →  
 10.6 \*                      9.6 ↗                      8.7 →                      9.9 ←                      9.8 →  
 beste Teiler 87.7 (6.) 92.6 (1.) 140.0 (2.)  
 Trefferlage 0.97 mm rechts, 0.00 mm  
 Streuwert 2.02, horizontal: 2.53, vertikal: 1.34

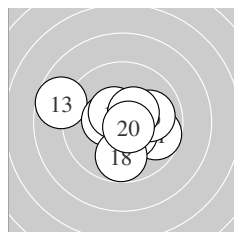

Serie 2:  
 9.7 →                      10.5 \*                      8.7 ←                      10.4 \*                      10.5 \*  
 10.0 →                      10.5 \*                      9.8 ↓                      10.5 \*                      10.7 \*  
 beste Teiler 66.0 (20.) 105.2 (12.) 111.1 (17.)  
 Trefferlage 0.05 mm rechts, 0.21 mm tief  
 Streuwert 1.86, horizontal: 2.28, vertikal: 1.31

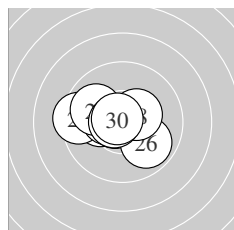

Serie 3:  
 10.6 \*                      10.2 \*                      9.4 ←                      10.4 \*                      10.7 \*  
 9.9 ↘                      9.9 ←                      10.4 \*                      10.7 \*                      10.7 \*  
 beste Teiler 54.7 (30.) 64.1 (25.) 72.0 (29.)  
 Trefferlage 0.88 mm links, 0.10 mm hoch  
 Streuwert 1.29, horizontal: 1.67, vertikal: 0.74

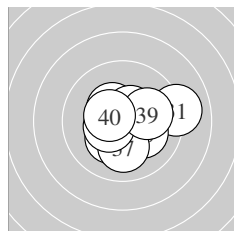

Serie 4:  
 9.1 →                      10.2 \*                      10.4 \*                      10.6 \*                      10.5 \*  
 10.2 \*                      10.1 ↓                      10.4 \*                      10.1 →                      10.5 \*  
 beste Teiler 83.8 (34.) 109.4 (35.) 123.6 (40.)  
 Trefferlage 0.57 mm rechts, 0.16 mm tief  
 Streuwert 1.55, horizontal: 1.87, vertikal: 1.14

Unterschrift des Schützen

Meyton Elektronik

Ergebnis: **411.9** (395)  
 Serien: 103.3 102.0 102.1 104.5  
 Zähler: 35 5 0 0 0 0 0 0 0 0  
 Innenzehner: 27  
 weiteste: 401 (27), 375 (24), 345 (20)  
 beste Teiler 32.6 (13.) 34.1 (21.) 35.4 (39.)  
 Trefferlage 0.80 mm links, 0.08 mm tief  
 Streuwert 1.20, horizontal: 1.46, vertikal: 0.87

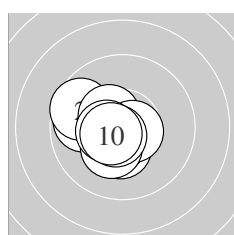
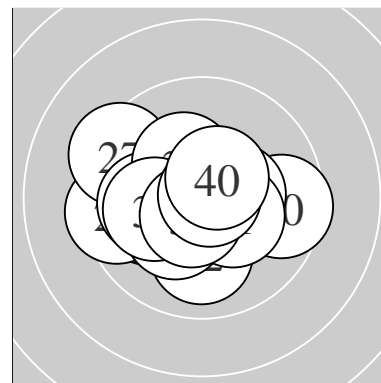

Serie 1:  
 9.8 ←                      9.6 ↖                      10.4 \*                      10.4 \*                      10.5 \*  
 10.6 \*                      10.3 \*                      10.6 \*                      10.5 \*                      10.6 \*  
 beste Teiler 77.4 (6.) 80.4 (8.) 96.7 (10.)  
 Trefferlage 1.00 mm links, 0.31 mm tief  
 Streuwert 1.04, horizontal: 1.13, vertikal: 0.93

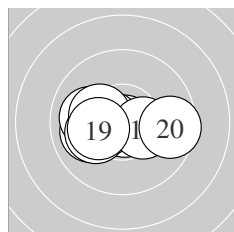

Serie 2:  
 10.0 ←                      10.1 ←                      10.8 \*                      10.0 ←                      10.1 ←  
 10.6 \*                      10.3 \*                      10.3 \*                      10.2 \*                      9.6 →  
 beste Teiler 32.6 (13.) 89.0 (16.) 152.8 (18.)  
 Trefferlage 0.79 mm links, 0.19 mm tief  
 Streuwert 1.39, horizontal: 1.92, vertikal: 0.43

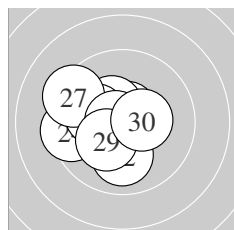

Serie 3:  
 10.8 \*                      10.0 ↓                      10.6 \*                      9.5 ←                      10.4 \*  
 10.1 ←                      9.3 ↖                      10.7 \*                      10.3 \*                      10.4 \*  
 beste Teiler 34.1 (21.) 51.0 (28.) 76.3 (23.)  
 Trefferlage 0.98 mm links, 0.01 mm tief  
 Streuwert 1.45, horizontal: 1.65, vertikal: 1.22

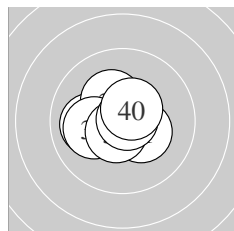

Serie 4:  
 10.3 \*                      10.7 \*                      10.0 ←                      10.6 \*                      10.6 \*  
 10.3 \*                      10.1 ←                      10.6 \*                      10.8 \*                      10.5 \*  
 beste Teiler 35.4 (39.) 65.3 (32.) 83.3 (34.)  
 Trefferlage 0.45 mm links, 0.16 mm hoch  
 Streuwert 0.96, horizontal: 1.14, vertikal: 0.75

Unterschrift des Schützen

Meyton Elektronik

Ergebnis: **418.0** (394)  
 Serien: 105.2 104.4 105.1 103.3  
 Zähler: 34 6 0 0 0 0 0 0 0 0  
 Innenzehner: 33  
 weiteste: 297 (19), 292 (39), 288 (4)  
 beste Teiler 13.6 (11.) 41.6 (27.) 42.2 (1.)  
 Trefferlage 0.34 mm rechts, 0.02 mm tief  
 Streuwert 1.05, horizontal: 1.26, vertikal: 0.78

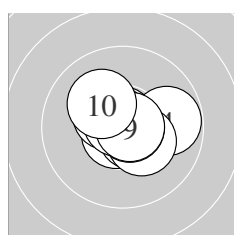
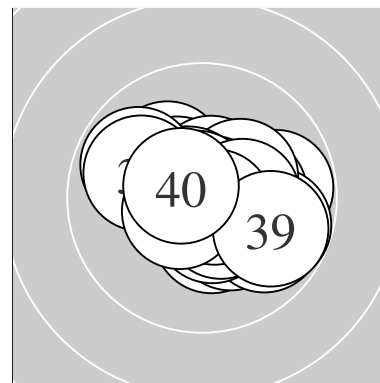

Serie 1:  
 10.8 \*                      10.7 \*                      10.6 \*                      9.8 →                      10.3 \*  
 10.8 \*                      10.5 \*                      10.8 \*                      10.8 \*                      10.1 ↖  
 beste Teiler 42.2 (1.) 46.7 (8.) 47.0 (6.)  
 Trefferlage 0.25 mm rechts, 0.15 mm hoch  
 Streuwert 0.98, horizontal: 1.20, vertikal: 0.69

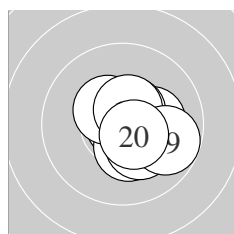

Serie 2:  
 10.9 \*                      10.4 \*                      10.2 \*                      10.3 \*                      10.7 \*  
 10.6 \*                      10.4 \*                      10.5 \*                      9.8 →                      10.6 \*  
 beste Teiler 13.6 (11.) 61.4 (15.) 97.9 (16.)  
 Trefferlage 0.71 mm rechts, 0.13 mm tief  
 Streuwert 0.99, horizontal: 1.03, vertikal: 0.94

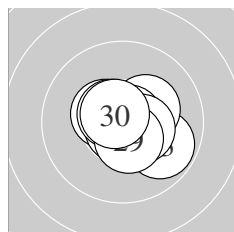

Serie 3:  
 10.5 \*                      10.8 \*                      9.8 ↘                      10.6 \*                      10.3 \*  
 10.6 \*                      10.8 \*                      10.5 \*                      10.5 \*                      10.7 \*  
 beste Teiler 41.6 (27.) 44.2 (22.) 73.5 (30.)  
 Trefferlage 0.41 mm rechts, 0.11 mm tief  
 Streuwert 0.94, horizontal: 1.10, vertikal: 0.75

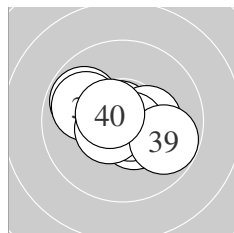

Serie 4:  
 10.8 \*                      10.4 \*                      10.3 \*                      9.8 ↖                      10.5 \*  
 10.7 \*                      9.9 ↖                      10.5 \*                      9.8 →                      10.6 \*  
 beste Teiler 42.5 (31.) 60.2 (36.) 94.5 (40.)  
 Trefferlage 0.01 mm rechts, 0.00 mm  
 Streuwert 1.32, horizontal: 1.69, vertikal: 0.79

Unterschrift des Schützen

Meyton Elektronik

Ergebnis: **411.3** (396)  
 Serien: 104.0 102.9 101.2 103.2  
 Zähler: 36 4 0 0 0 0 0 0 0 0  
 Innenzehner: 32  
 weiteste: 429 (21), 426 (24), 377 (29)  
 beste Teiler 39.1 (12.) 47.0 (31.) 57.3 (18.)  
 Trefferlage 0.18 mm rechts, 0.07 mm tief  
 Streuwert 1.34, horizontal: 1.63, vertikal: 0.97

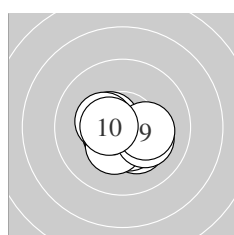
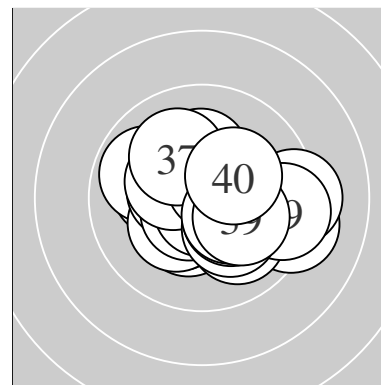

Serie 1:  
 10.5 \*                      10.5 \*                      10.6 \*                      10.3 \*                      10.5 \*  
 10.3 \*                      10.2 \*                      10.4 \*                      10.2 \*                      10.5 \*  
 beste Teiler 96.8 (3.) 102.6 (1.) 105.3 (10.)  
 Trefferlage 0.05 mm links, 0.52 mm tief  
 Streuwert 0.99, horizontal: 1.22, vertikal: 0.69

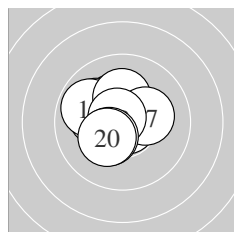

Serie 2:  
 10.3 \*                      10.8 \*                      10.0 ↖                      10.2 \*                      9.9 ↖  
 10.2 \*                      10.2 \*                      10.7 \*                      10.3 \*                      10.3 \*  
 beste Teiler 39.1 (12.) 57.3 (18.) 152.1 (19.)  
 Trefferlage 0.78 mm links, 0.44 mm hoch  
 Streuwert 1.15, horizontal: 1.27, vertikal: 1.03

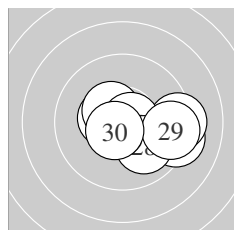

Serie 3:  
 9.2 ↗                      10.6 \*                      10.4 \*                      9.2 →                      10.6 \*  
 10.5 \*                      10.7 \*                      10.0 ↘                      9.4 →                      10.6 \*  
 beste Teiler 63.1 (27.) 77.1 (25.) 89.1 (30.)  
 Trefferlage 1.13 mm rechts, 0.33 mm tief  
 Streuwert 1.64, horizontal: 2.19, vertikal: 0.77

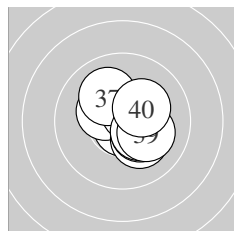

Serie 4:  
 10.8 \*                      10.3 \*                      10.3 \*                      10.6 \*                      10.2 \*  
 10.3 \*                      10.1 ↖                      10.3 \*                      10.1 ↘                      10.2 \*  
 beste Teiler 47.0 (31.) 90.6 (34.) 152.6 (38.)  
 Trefferlage 0.45 mm rechts, 0.13 mm hoch  
 Streuwert 1.17, horizontal: 1.18, vertikal: 1.16

Unterschrift des Schützen

Meyton Elektronik

Ergebnis: **406.1** (387)  
 Serien: 100.7 100.9 101.2 103.3  
 Zähler: 28 11 1 0 0 0 0 0 0 0  
 Innenzehner: 21  
 weiteste: 542 (20), 383 (27), 346 (2)  
 beste Teiler 16.1 (35.) 17.0 (40.) 45.3 (12.)  
 Trefferlage 0.26 mm rechts, 0.19 mm hoch  
 Streuwert 1.63, horizontal: 2.05, vertikal: 1.04

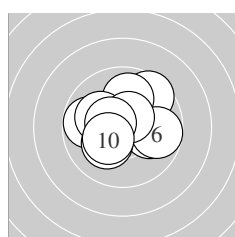
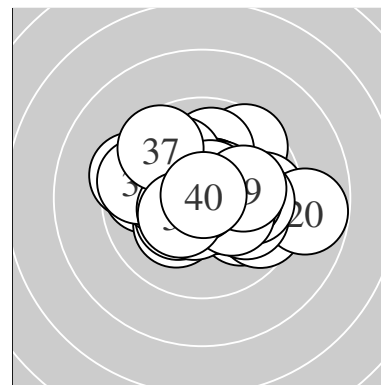

Serie 1:  
 10.0 → 9.6 ↗ 9.9 ↑ 9.8 ← 10.1 ↖  
 9.7 → 10.6 \* 10.5 \* 10.2 \* 10.3 \*  
 beste Teiler 100.4 (7.) 111.6 (8.) 159.4 (10.)  
 Trefferlage 0.00 mm , 0.42 mm hoch  
 Streuwert 1.72, horizontal: 2.01, vertikal: 1.35

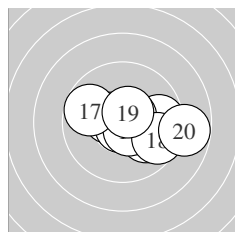

Serie 2:  
 10.5 \* 10.8 \* 9.7 → 10.6 \* 10.0 ↘  
 10.6 \* 9.7 ← 9.6 ↘ 10.6 \* 8.8 →  
 beste Teiler 45.3 (12.) 87.6 (14.) 89.0 (16.)  
 Trefferlage 1.11 mm rechts, 0.16 mm tief  
 Streuwert 1.78, horizontal: 2.37, vertikal: 0.87

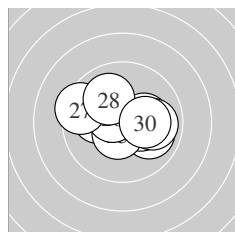

Serie 3:  
 10.2 \* 10.0 → 10.3 \* 10.1 ← 10.5 \*  
 10.6 \* 9.4 ← 10.0 ↘ 9.9 → 10.2 \*  
 beste Teiler 99.3 (26.) 107.5 (25.) 159.4 (23.)  
 Trefferlage 0.20 mm rechts, 0.19 mm hoch  
 Streuwert 1.65, horizontal: 2.15, vertikal: 0.91

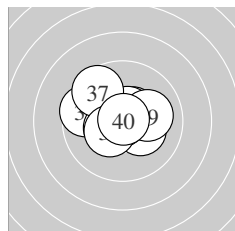

Serie 4:  
 9.6 ← 10.3 \* 10.5 \* 10.4 \* 10.9 \*  
 10.6 \* 9.6 ↘ 10.4 \* 10.1 → 10.9 \*  
 beste Teiler 16.1 (35.) 17.0 (40.) 88.1 (36.)  
 Trefferlage 0.27 mm links, 0.33 mm hoch  
 Streuwert 1.39, horizontal: 1.67, vertikal: 1.02

Unterschrift des Schützen

Meyton Elektronik

Ergebnis: **403.2** (387)  
 Serien: 98.7 102.3 101.5 100.7  
 Zähler: 27 13 0 0 0 0 0 0 0 0  
 Innenzehner: 16  
 weiteste: 425 (7), 379 (28), 330 (3)  
 beste Teiler 82.9 (27.) 89.4 (16.) 102.6 (12.)  
 Trefferlage 0.11 mm links, 0.12 mm tief  
 Streuwert 1.67, horizontal: 2.08, vertikal: 1.10

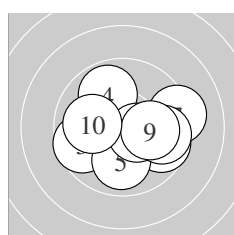
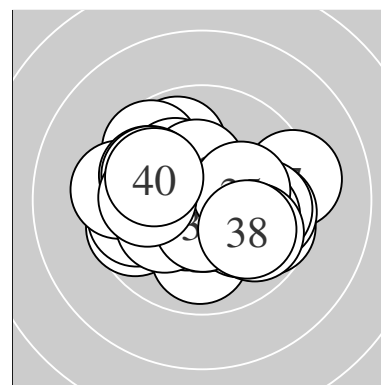

Serie 1:  
 10.0 ←                      9.7 →                      9.6 ←                      9.9 ↗                      9.9 ↓  
 10.5 \*                      9.3 →                      9.7 →                      10.1 →                      10.0 ←  
 beste Teiler 116.8 (6.) 211.3 (9.) 232.3 (10.)  
 Trefferlage 0.43 mm rechts, 0.28 mm tief  
 Streuwert 2.06, horizontal: 2.59, vertikal: 1.34

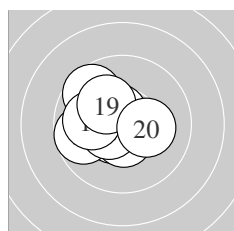

Serie 2:  
 9.6 ↘                      10.5 \*                      10.5 \*                      9.7 ←                      10.5 \*  
 10.6 \*                      10.5 \*                      10.0 ←                      10.2 \*                      10.2 \*  
 beste Teiler 89.4 (16.) 102.6 (12.) 104.3 (13.)  
 Trefferlage 0.98 mm links, 0.24 mm hoch  
 Streuwert 1.25, horizontal: 1.38, vertikal: 1.10

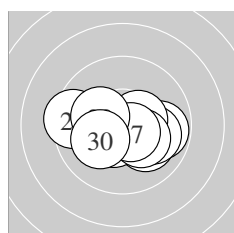

Serie 3:  
 10.1 ↘                      10.5 \*                      9.8 →                      10.0 →                      10.5 \*  
 10.3 \*                      10.6 \*                      9.4 ←                      10.2 \*                      10.1 ←  
 beste Teiler 82.9 (27.) 118.7 (22.) 125.5 (25.)  
 Trefferlage 0.21 mm rechts, 0.45 mm tief  
 Streuwert 1.57, horizontal: 2.10, vertikal: 0.72

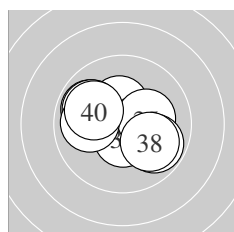

Serie 4:  
 9.9 ↘                      10.4 \*                      10.0 ↘                      10.5 \*                      10.2 \*  
 9.8 ↘                      9.9 ↘                      10.0 ↘                      10.0 ←                      10.0 ↘  
 beste Teiler 104.0 (34.) 145.1 (32.) 183.8 (35.)  
 Trefferlage 0.13 mm links, 0.01 mm hoch  
 Streuwert 1.72, horizontal: 2.12, vertikal: 1.18

Unterschrift des Schützen

Meyton Elektronik

Ergebnis: **411.3** (396)  
 Serien: 103.8 101.4 101.8 104.3  
 Zähler: 36 4 0 0 0 0 0 0 0 0  
 Innenzehner: 25  
 weiteste: 463 (14), 325 (11), 300 (24)  
 beste Teiler 42.4 (16.) 52.6 (33.) 60.0 (5.)  
 Trefferlage 0.34 mm links, 0.14 mm hoch  
 Streuwert 1.33, horizontal: 1.67, vertikal: 0.86

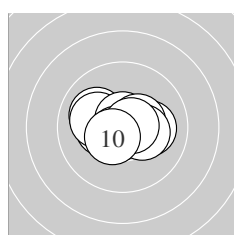
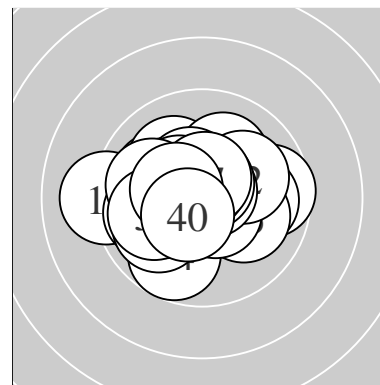

Serie 1:  
 10.1 → 10.3 \* 10.0 ↖ 10.1 ↖ 10.7 \*  
 10.4 \* 10.7 \* 10.3 \* 10.7 \* 10.5 \*  
 beste Teiler 60.0 (5.) 70.0 (9.) 73.0 (7.)  
 Trefferlage 0.13 mm links, 0.07 mm hoch  
 Streuwert 1.13, horizontal: 1.50, vertikal: 0.56

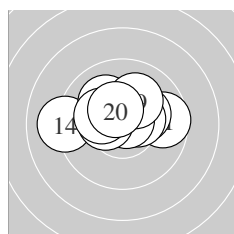

Serie 2:  
 9.7 → 10.2 \* 10.4 \* 9.1 ← 10.1 ↖  
 10.8 \* 10.4 \* 10.2 \* 10.1 ↗ 10.4 \*  
 beste Teiler 42.4 (16.) 128.7 (13.) 130.1 (20.)  
 Trefferlage 0.21 mm links, 0.74 mm hoch  
 Streuwert 1.62, horizontal: 2.20, vertikal: 0.65

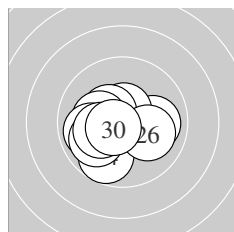

Serie 3:  
 10.0 → 10.6 \* 10.4 \* 9.8 ↙ 10.2 \*  
 10.1 → 9.9 ← 10.0 ↙ 10.2 \* 10.6 \*  
 beste Teiler 86.9 (30.) 91.5 (22.) 134.2 (23.)  
 Trefferlage 0.68 mm links, 0.48 mm tief  
 Streuwert 1.42, horizontal: 1.70, vertikal: 1.06

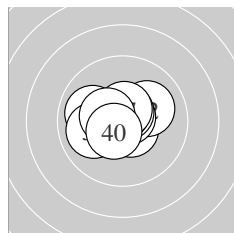

Serie 4:  
 10.6 \* 10.1 ↗ 10.7 \* 10.0 ↖ 10.7 \*  
 10.7 \* 10.6 \* 10.0 ← 10.4 \* 10.5 \*  
 beste Teiler 52.6 (33.) 69.3 (36.) 75.0 (35.)  
 Trefferlage 0.33 mm links, 0.24 mm hoch  
 Streuwert 1.08, horizontal: 1.36, vertikal: 0.71

Unterschrift des Schützen

Meyton Elektronik

Ergebnis: **420.2** (400)  
 Serien: 104.6 105.1 104.9 105.6  
 Zähler: 40 0 0 0 0 0 0 0 0 0  
 Innenzehner: 38  
 weiteste: 213 (6), 213 (12), 194 (28)  
 beste Teiler 22.5 (5.) 30.4 (31.) 31.8 (26.)  
 Trefferlage 0.08 mm rechts, 0.09 mm hoch  
 Streuwert 0.88, horizontal: 1.05, vertikal: 0.67

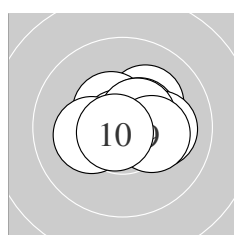
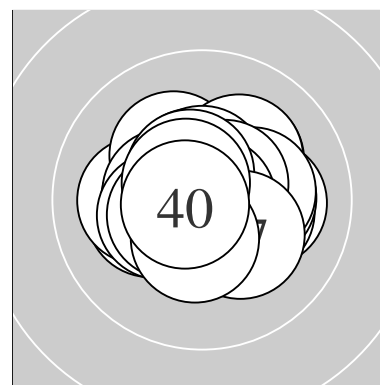

Serie 1:  
 10.2 \*                      10.5 \*                      10.5 \*                      10.7 \*                      10.9 \*  
 10.1 →                      10.5 \*                      10.2 \*                      10.3 \*                      10.7 \*  
 beste Teiler 22.5 (5.) 54.6 (10.) 68.6 (4.)  
 Trefferlage 0.45 mm rechts, 0.24 mm hoch  
 Streuwert 0.97, horizontal: 1.21, vertikal: 0.63

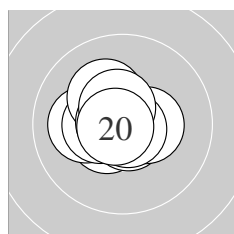

Serie 2:  
 10.5 \*                      10.1 ←                      10.4 \*                      10.2 \*                      10.7 \*  
 10.4 \*                      10.7 \*                      10.8 \*                      10.5 \*                      10.8 \*  
 beste Teiler 43.9 (18.) 45.5 (20.) 51.4 (17.)  
 Trefferlage 0.45 mm links, 0.09 mm hoch  
 Streuwert 0.84, horizontal: 0.97, vertikal: 0.67

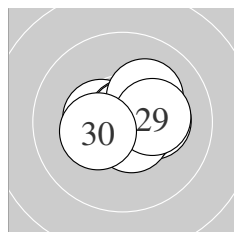

Serie 3:  
 10.4 \*                      10.2 \*                      10.6 \*                      10.8 \*                      10.8 \*  
 10.8 \*                      10.6 \*                      10.2 \*                      10.2 \*                      10.3 \*  
 beste Teiler 31.8 (26.) 32.2 (25.) 48.8 (24.)  
 Trefferlage 0.35 mm rechts, 0.07 mm hoch  
 Streuwert 0.91, horizontal: 1.13, vertikal: 0.60

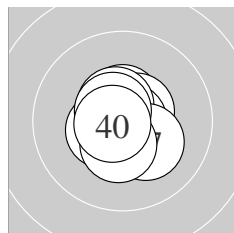

Serie 4:  
 10.8 \*                      10.5 \*                      10.6 \*                      10.8 \*                      10.5 \*  
 10.5 \*                      10.2 \*                      10.6 \*                      10.4 \*                      10.7 \*  
 beste Teiler 30.4 (31.) 34.0 (34.) 62.0 (40.)  
 Trefferlage 0.02 mm links, 0.03 mm tief  
 Streuwert 0.78, horizontal: 0.72, vertikal: 0.83

Unterschrift des Schützen

Meyton Elektronik



Ergebnis: **397.7** (377)  
 Serien: 100.0 99.6 97.1 101.0  
 Zähler: 22 13 5 0 0 0 0 0 0 0  
 Innenzehner: 20  
 weiteste: 618 (14), 616 (24), 611 (37)  
 beste Teiler 5.0 (34.) 44.8 (31.) 56.9 (32.)  
 Trefferlage 0.17 mm links, 1.27 mm hoch  
 Streuwert 1.98, horizontal: 2.06, vertikal: 1.90

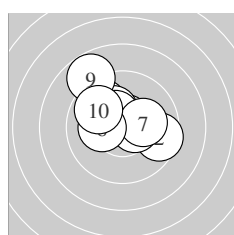
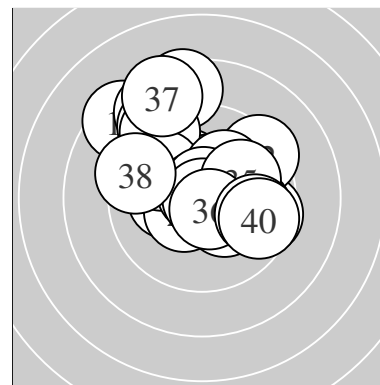

Serie 1:  
 9.8 ↘                      9.5 →                      10.6 \*                      10.2 \*                      10.5 \*  
 10.4 \*                      10.2 \*                      10.2 \*                      8.8 ↘                      9.8 ↘  
 beste Teiler 85.6 (3.) 114.6 (5.) 136.1 (6.)  
 Trefferlage 0.37 mm links, 1.13 mm hoch  
 Streuwert 1.80, horizontal: 2.04, vertikal: 1.53

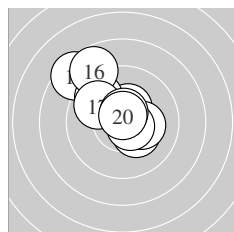

Serie 2:  
 10.4 \*                      10.3 \*                      10.2 \*                      8.5 ↘                      9.7 ↘  
 8.8 ↘                      9.8 ↘                      10.6 \*                      10.6 \*                      10.7 \*  
 beste Teiler 62.0 (20.) 82.7 (18.) 91.7 (19.)  
 Trefferlage 0.72 mm links, 1.41 mm hoch  
 Streuwert 1.99, horizontal: 2.04, vertikal: 1.94

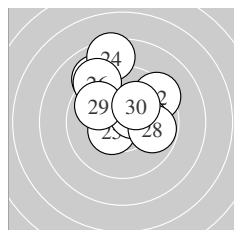

Serie 3:  
 9.1 ↘                      9.4 ↗                      10.1 →                      8.5 ↑                      10.4 \*  
 9.2 ↘                      10.5 \*                      9.8 →                      9.9 ↘                      10.2 \*  
 beste Teiler 122.0 (27.) 126.2 (25.) 197.7 (30.)  
 Trefferlage 0.10 mm rechts, 1.86 mm hoch  
 Streuwert 2.20, horizontal: 2.19, vertikal: 2.20

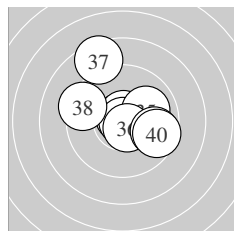

Serie 4:  
 10.8 \*                      10.7 \*                      10.7 \*                      10.9 \*                      10.0 ↗  
 10.7 \*                      8.5 ↘                      9.4 ↖                      9.7 →                      9.6 →  
 beste Teiler 5.0 (34.) 44.8 (31.) 56.9 (32.)  
 Trefferlage 0.28 mm rechts, 0.67 mm hoch  
 Streuwert 2.05, horizontal: 2.16, vertikal: 1.94

Unterschrift des Schützen

Ergebnis: **416.0** (394)  
 Serien: 104.5 103.6 102.3 105.6  
 Zähler: 34 6 0 0 0 0 0 0 0 0  
 Innenzehner: 31  
 weiteste: 299 (25), 290 (21), 269 (13)  
 beste Teiler 16.1 (6.) 25.4 (33.) 28.0 (30.)  
 Trefferlage 0.06 mm rechts, 0.18 mm hoch  
 Streuwert 1.14, horizontal: 1.26, vertikal: 1.01

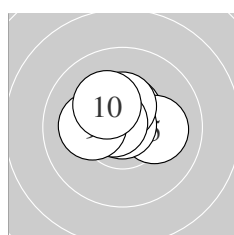
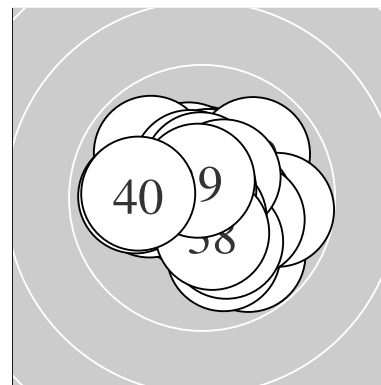

Serie 1:  
 10.5 \*                      10.7 \*                      10.3 \*                      10.5 \*                      10.1 →  
 10.9 \*                      10.4 \*                      10.7 \*                      10.2 \*                      10.2 \*  
 beste Teiler 16.1 (6.) 66.6 (8.) 74.0 (2.)  
 Trefferlage 0.23 mm links, 0.74 mm hoch  
 Streuwert 0.87, horizontal: 1.07, vertikal: 0.60

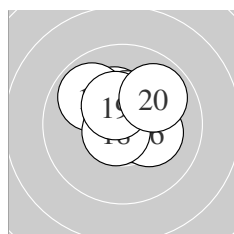

Serie 2:  
 10.3 \*                      10.5 \*                      9.9 ↘                      10.7 \*                      10.4 \*  
 10.2 \*                      10.6 \*                      10.7 \*                      10.4 \*                      9.9 ↗  
 beste Teiler 65.1 (18.) 67.6 (14.) 80.1 (17.)  
 Trefferlage 0.19 mm rechts, 0.67 mm hoch  
 Streuwert 1.09, horizontal: 1.22, vertikal: 0.96

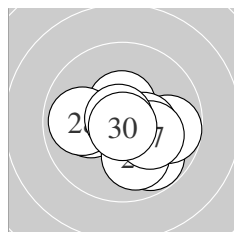

Serie 3:  
 9.8 ↘                      10.1 ←                      10.5 \*                      10.0 ↘                      9.8 →  
 10.4 \*                      10.2 \*                      9.9 ←                      10.8 \*                      10.8 \*  
 beste Teiler 28.0 (30.) 34.6 (29.) 113.1 (23.)  
 Trefferlage 0.37 mm rechts, 0.50 mm tief  
 Streuwert 1.45, horizontal: 1.76, vertikal: 1.05

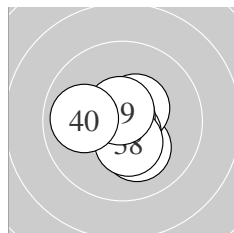

Serie 4:  
 10.8 \*                      10.8 \*                      10.9 \*                      10.2 \*                      10.5 \*  
 10.6 \*                      10.8 \*                      10.4 \*                      10.7 \*                      9.9 ←  
 beste Teiler 25.4 (33.) 30.8 (31.) 31.9 (37.)  
 Trefferlage 0.06 mm links, 0.18 mm tief  
 Streuwert 0.91, horizontal: 0.96, vertikal: 0.86

Unterschrift des Schützen

Meyton Elektronik