

Ergebnis: **417.7** (398)  
 Serien: 105.2 104.4 104.5 103.6  
 Zähler: 38 2 0 0 0 0 0 0 0 0  
 Innenzehner: 37  
 weiteste: 306 (32), 285 (14), 206 (33)  
 beste Teiler 14.7 (11.) 21.0 (4.) 44.6 (36.)  
 Trefferlage 0.51 mm links, 0.32 mm tief  
 Streuwert 0.91, horizontal: 1.15, vertikal: 0.59

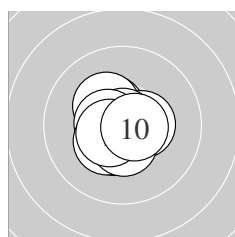

Serie 1:  
 10.4 \* 10.4 \* 10.3 \* 10.9 \* 10.5 \*  
 10.6 \* 10.4 \* 10.5 \* 10.6 \* 10.6 \*  
 beste Teiler 21.0 (4.) 80.0 (10.) 99.9 (6.)  
 Trefferlage 0.31 mm links, 0.12 mm tief  
 Streuwert 0.84, horizontal: 0.82, vertikal: 0.86

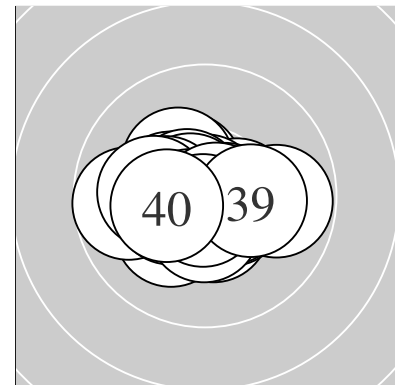
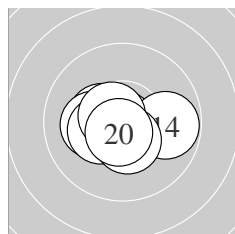

Serie 2:  
 10.9 \* 10.4 \* 10.4 \* 9.8 → 10.2 \*  
 10.6 \* 10.3 \* 10.5 \* 10.6 \* 10.7 \*  
 beste Teiler 14.7 (11.) 72.4 (20.) 83.3 (19.)  
 Trefferlage 0.45 mm links, 0.23 mm tief  
 Streuwert 1.02, horizontal: 1.35, vertikal: 0.51

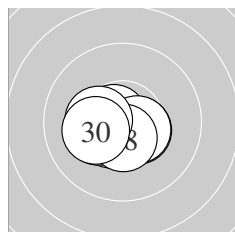

Serie 3:  
 10.4 \* 10.5 \* 10.5 \* 10.7 \* 10.3 \*  
 10.6 \* 10.5 \* 10.5 \* 10.3 \* 10.2 \*  
 beste Teiler 64.0 (24.) 85.6 (26.) 105.1 (28.)  
 Trefferlage 0.51 mm links, 0.45 mm tief  
 Streuwert 0.82, horizontal: 1.09, vertikal: 0.41

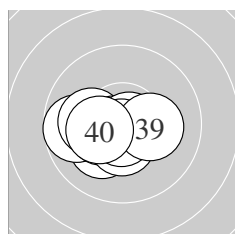

Serie 4:  
 10.2 \* 9.7 ← 10.1 ← 10.4 \* 10.7 \*  
 10.8 \* 10.5 \* 10.7 \* 10.2 \* 10.3 \*  
 beste Teiler 44.6 (36.) 58.5 (38.) 70.1 (35.)  
 Trefferlage 0.78 mm links, 0.48 mm tief  
 Streuwert 1.04, horizontal: 1.39, vertikal: 0.47

Unterschrift des Schützen

Ergebnis: **411.7** (393)  
 Serien: 104.1 99.5 103.1 105.0  
 Zähler: 33 7 0 0 0 0 0 0 0 0  
 Innenzehner: 26  
 weiteste: 456 (30), 432 (19), 380 (18)  
 beste Teiler 10.6 (35.) 30.4 (23.) 32.7 (22.)  
 Trefferlage 0.11 mm links, 0.00 mm  
 Streuwert 1.44, horizontal: 1.54, vertikal: 1.34

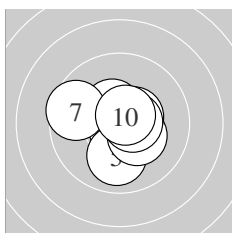
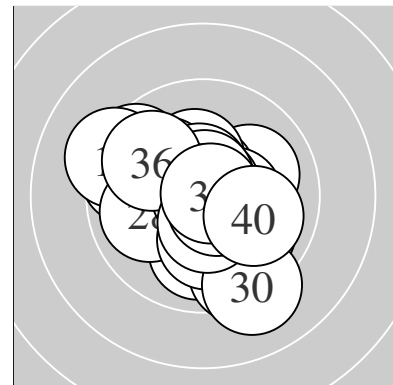

Serie 1:  
 10.5 \*                      10.5 \*                      10.8 \*                      10.6 \*                      10.0 ↓  
 10.3 \*                      9.6 ↖                      10.5 \*                      10.6 \*                      10.7 \*  
 beste Teiler 36.1 (3.) 74.4 (10.) 96.0 (4.)  
 Trefferlage 0.07 mm rechts, 0.17 mm tief  
 Streuwert 1.21, horizontal: 1.33, vertikal: 1.07

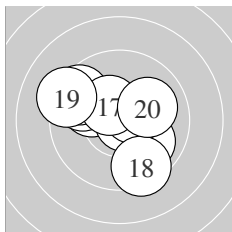

Serie 2:  
 10.0 ↘                      10.0 ↖                      9.7 ↖                      9.5 ↖                      10.8 \*  
 10.5 \*                      10.4 \*                      9.4 ↓                      9.2 ↖                      10.0 →  
 beste Teiler 39.5 (15.) 111.3 (16.) 133.9 (17.)  
 Trefferlage 0.55 mm links, 0.34 mm hoch  
 Streuwert 1.99, horizontal: 2.26, vertikal: 1.67

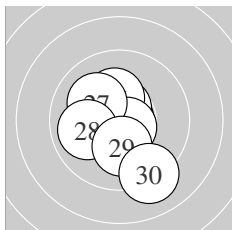

Serie 3:  
 10.5 \*                      10.8 \*                      10.8 \*                      10.6 \*                      10.3 \*  
 10.7 \*                      10.1 ↖                      10.0 ←                      10.2 \*                      9.1 ↓  
 beste Teiler 30.4 (23.) 32.7 (22.) 74.9 (26.)  
 Trefferlage 0.22 mm links, 0.31 mm tief  
 Streuwert 1.49, horizontal: 1.28, vertikal: 1.67

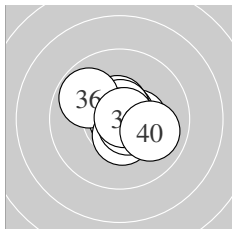

Serie 4:  
 10.4 \*                      10.8 \*                      10.5 \*                      10.7 \*                      10.9 \*  
 9.8 ↖                      10.5 \*                      10.6 \*                      10.8 \*                      10.0 →  
 beste Teiler 10.6 (35.) 35.7 (39.) 50.3 (32.)  
 Trefferlage 0.26 mm rechts, 0.12 mm hoch  
 Streuwert 1.02, horizontal: 1.16, vertikal: 0.85

Unterschrift des Schützen

Meyton Elektronik

Ergebnis: **422.9** (400)  
 Serien: 105.3 106.3 105.7 105.6  
 Zähler: 40 0 0 0 0 0 0 0 0 0  
 Innenzehner: 38  
 weiteste: 233 (40), 213 (4), 187 (12)  
 beste Teiler 14.1 (15.) 17.1 (29.) 33.2 (14.)  
 Trefferlage 0.24 mm links, 0.08 mm tief  
 Streuwert 0.75, horizontal: 0.89, vertikal: 0.59

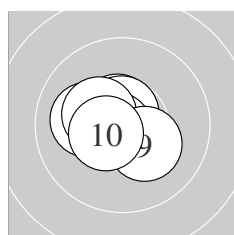
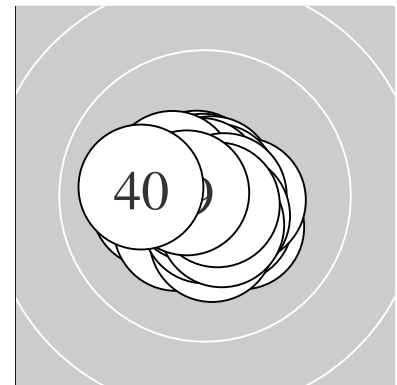

Serie 1:  
 10.6 \*                      10.7 \*                      10.8 \*                      10.1 ←                      10.6 \*  
 10.7 \*                      10.7 \*                      10.3 \*                      10.3 \*                      10.5 \*  
 beste Teiler 44.5 (3.) 51.4 (7.) 66.8 (2.)  
 Trefferlage 0.56 mm links, 0.08 mm hoch  
 Streuwert 0.78, horizontal: 0.91, vertikal: 0.63

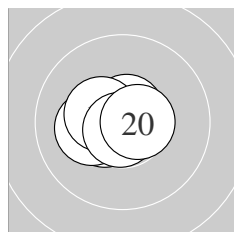

Serie 2:  
 10.5 \*                      10.2 \*                      10.7 \*                      10.8 \*                      10.9 \*  
 10.7 \*                      10.7 \*                      10.4 \*                      10.8 \*                      10.6 \*  
 beste Teiler 14.1 (15.) 33.2 (14.) 48.3 (19.)  
 Trefferlage 0.35 mm links, 0.02 mm hoch  
 Streuwert 0.66, horizontal: 0.85, vertikal: 0.40

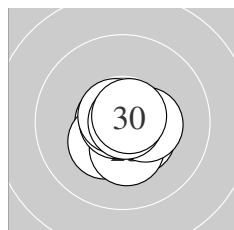

Serie 3:  
 10.4 \*                      10.5 \*                      10.7 \*                      10.3 \*                      10.3 \*  
 10.8 \*                      10.7 \*                      10.4 \*                      10.9 \*                      10.7 \*  
 beste Teiler 17.1 (29.) 36.3 (26.) 53.0 (30.)  
 Trefferlage 0.16 mm rechts, 0.33 mm tief  
 Streuwert 0.72, horizontal: 0.78, vertikal: 0.66

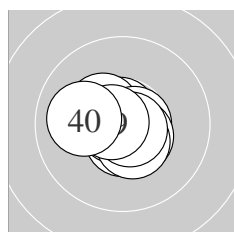

Serie 4:  
 10.7 \*                      10.4 \*                      10.6 \*                      10.8 \*                      10.7 \*  
 10.5 \*                      10.5 \*                      10.7 \*                      10.7 \*                      10.0 ←  
 beste Teiler 45.6 (34.) 54.4 (38.) 58.5 (31.)  
 Trefferlage 0.22 mm links, 0.12 mm tief  
 Streuwert 0.82, horizontal: 0.98, vertikal: 0.62

Unterschrift des Schützen

Meyton Elektronik

Ergebnis: **422.0** (400)  
 Serien: 105.0 106.5 104.7 105.8  
 Zähler: 40 0 0 0 0 0 0 0 0 0  
 Innenzehner: 38  
 weiteste: 232 (26), 205 (4), 199 (10)  
 beste Teiler 32.2 (38.) 39.3 (3.) 42.2 (37.)  
 Trefferlage 0.01 mm links, 0.16 mm tief  
 Streuwert 0.80, horizontal: 0.89, vertikal: 0.70

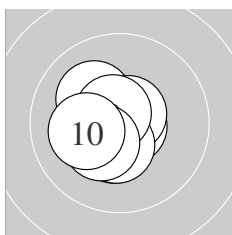
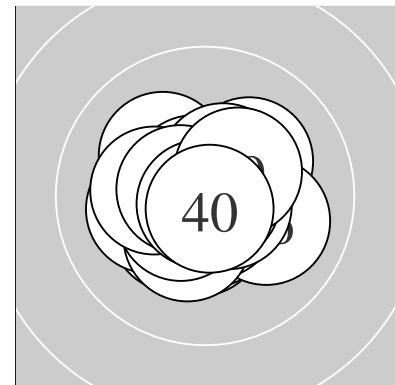

Serie 1:  
 10.7 \*                      10.7 \*                      10.8 \*                      10.1 ↘                      10.7 \*  
 10.4 \*                      10.4 \*                      10.7 \*                      10.3 \*                      10.2 \*  
 beste Teiler 39.3 (3.) 51.9 (1.) 55.6 (2.)  
 Trefferlage 0.50 mm links, 0.22 mm tief  
 Streuwert 0.84, horizontal: 0.80, vertikal: 0.88

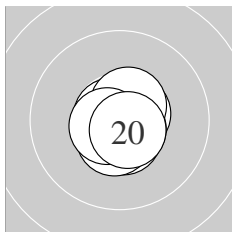

Serie 2:  
 10.7 \*                      10.7 \*                      10.6 \*                      10.8 \*                      10.6 \*  
 10.5 \*                      10.7 \*                      10.6 \*                      10.6 \*                      10.7 \*  
 beste Teiler 50.9 (14.) 51.6 (12.) 62.8 (11.)  
 Trefferlage 0.00 mm , 0.24 mm tief  
 Streuwert 0.57, horizontal: 0.54, vertikal: 0.59

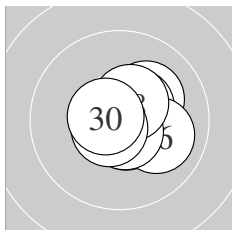

Serie 3:  
 10.3 \*                      10.2 \*                      10.5 \*                      10.6 \*                      10.7 \*  
 10.0 →                      10.7 \*                      10.5 \*                      10.6 \*                      10.6 \*  
 beste Teiler 53.8 (25.) 73.3 (27.) 76.8 (29.)  
 Trefferlage 0.57 mm rechts, 0.00 mm  
 Streuwert 0.90, horizontal: 1.02, vertikal: 0.76

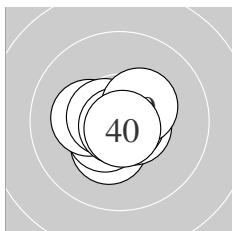

Serie 4:  
 10.3 \*                      10.5 \*                      10.2 \*                      10.8 \*                      10.6 \*  
 10.6 \*                      10.8 \*                      10.8 \*                      10.4 \*                      10.8 \*  
 beste Teiler 32.2 (38.) 42.2 (37.) 46.0 (34.)  
 Trefferlage 0.13 mm links, 0.20 mm tief  
 Streuwert 0.77, horizontal: 0.90, vertikal: 0.62

Unterschrift des Schützen

Meyton Elektronik

Ergebnis: **408.9** (389)  
 Serien: 104.5 101.3 101.0 102.1  
 Zähler: 29 11 0 0 0 0 0 0 0 0  
 Innenzehner: 24  
 weiteste: 408 (12), 406 (13), 392 (39)  
 beste Teiler 35.3 (15.) 72.1 (2.) 72.1 (36.)  
 Trefferlage 0.04 mm links, 0.07 mm tief  
 Streuwert 1.50, horizontal: 1.79, vertikal: 1.14

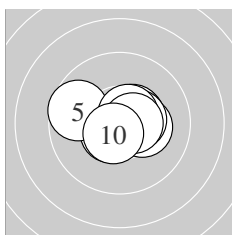
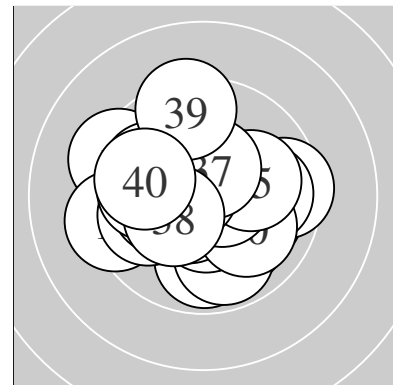

Serie 1:  
 10.5 \*                      10.7 \*                      10.3 \*                      10.6 \*                      9.7 ↖  
 10.5 \*                      10.4 \*                      10.6 \*                      10.6 \*                      10.6 \*  
 beste Teiler 72.1 (2.) 89.0 (8.) 89.3 (10.)  
 Trefferlage 0.16 mm rechts, 0.09 mm hoch  
 Streuwert 1.08, horizontal: 1.42, vertikal: 0.58

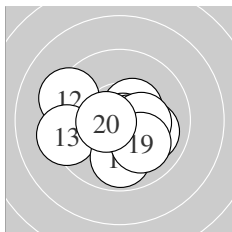

Serie 2:  
 10.0 ↗                      9.3 ↖                      9.3 ←                      10.4 \*                      10.8 \*  
 9.9 ↓                      10.7 \*                      10.3 \*                      10.0 ↘                      10.6 \*  
 beste Teiler 35.3 (15.) 75.8 (17.) 100.8 (20.)  
 Trefferlage 0.14 mm links, 0.48 mm tief  
 Streuwert 1.75, horizontal: 2.14, vertikal: 1.23

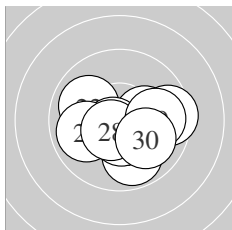

Serie 3:  
 10.2 \*                      9.9 ↖                      9.5 →                      9.8 ↘                      10.7 \*  
 10.5 \*                      9.9 ←                      10.6 \*                      9.9 →                      10.0 ↘  
 beste Teiler 74.3 (25.) 97.9 (28.) 116.8 (26.)  
 Trefferlage 0.52 mm rechts, 0.54 mm tief  
 Streuwert 1.61, horizontal: 2.03, vertikal: 1.05

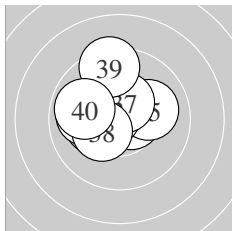

Serie 4:  
 10.2 \*                      10.5 \*                      10.6 \*                      10.0 ←                      10.1 →  
 10.7 \*                      10.4 \*                      10.3 \*                      9.4 ↑                      9.9 ↖  
 beste Teiler 72.1 (36.) 85.0 (33.) 114.2 (32.)  
 Trefferlage 0.73 mm links, 0.63 mm hoch  
 Streuwert 1.39, horizontal: 1.49, vertikal: 1.28

Unterschrift des Schützen

Meyton Elektronik

Ergebnis: **420.6** (397)  
 Serien: 105.3 105.9 104.9 104.5  
 Zähler: 37 3 0 0 0 0 0 0 0 0  
 Innenzehner: 36  
 weiteste: 309 (40), 287 (32), 266 (7)  
 beste Teiler 8.4 (8.) 9.8 (25.) 14.5 (19.)  
 Trefferlage 0.34 mm rechts, 0.22 mm hoch  
 Streuwert 0.91, horizontal: 1.18, vertikal: 0.50

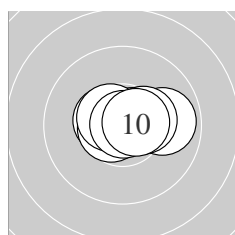
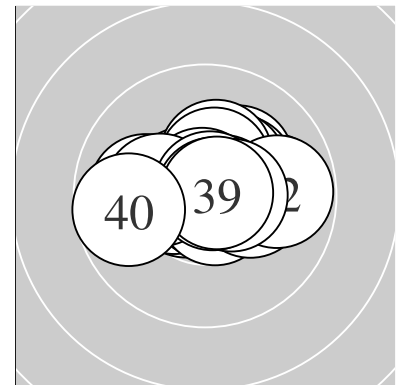

Serie 1:  
 10.7 \*                      10.4 \*                      10.5 \*                      10.6 \*                      10.7 \*  
 10.6 \*                      9.9 →                      10.9 \*                      10.4 \*                      10.6 \*  
 beste Teiler 8.4 (8.) 69.6 (5.) 74.0 (1.)  
 Trefferlage 0.36 mm rechts, 0.24 mm hoch  
 Streuwert 0.87, horizontal: 1.21, vertikal: 0.20

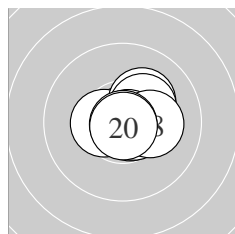

Serie 2:  
 10.7 \*                      10.9 \*                      10.5 \*                      10.2 \*                      10.3 \*  
 10.6 \*                      10.8 \*                      10.2 \*                      10.9 \*                      10.8 \*  
 beste Teiler 14.5 (19.) 25.6 (12.) 26.6 (20.)  
 Trefferlage 0.50 mm rechts, 0.12 mm hoch  
 Streuwert 0.73, horizontal: 0.86, vertikal: 0.58

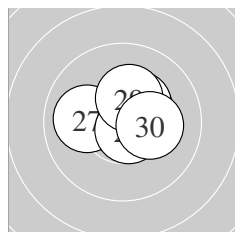

Serie 3:  
 10.4 \*                      10.8 \*                      10.3 \*                      10.6 \*                      10.9 \*  
 10.7 \*                      10.0 ←                      10.7 \*                      10.3 \*                      10.2 \*  
 beste Teiler 9.8 (25.) 48.1 (22.) 65.6 (28.)  
 Trefferlage 0.42 mm rechts, 0.31 mm hoch  
 Streuwert 0.92, horizontal: 1.11, vertikal: 0.69

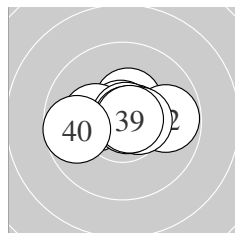

Serie 4:  
 10.4 \*                      9.8 →                      10.8 \*                      10.2 \*                      10.7 \*  
 10.8 \*                      10.5 \*                      10.8 \*                      10.8 \*                      9.7 ←  
 beste Teiler 31.0 (38.) 38.5 (36.) 48.5 (33.)  
 Trefferlage 0.09 mm rechts, 0.23 mm hoch  
 Streuwert 1.17, horizontal: 1.59, vertikal: 0.45

Unterschrift des Schützen

Meyton Elektronik

Ergebnis: **413.9** (396)  
 Serien: 104.3 103.8 103.7 102.1  
 Zähler: 36 4 0 0 0 0 0 0 0 0  
 Innenzehner: 33  
 weiteste: 352 (11), 328 (38), 281 (31)  
 beste Teiler 53.1 (13.) 59.2 (17.) 60.1 (10.)  
 Trefferlage 0.06 mm rechts, 0.18 mm hoch  
 Streuwert 1.18, horizontal: 1.22, vertikal: 1.14

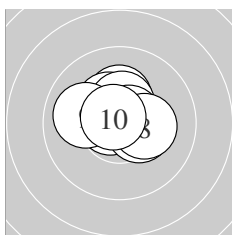
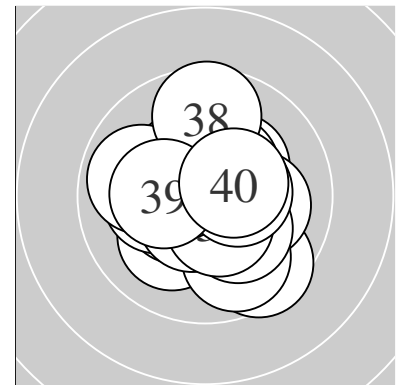

Serie 1:  
 10.3 \*                      10.4 \*                      10.4 \*                      10.7 \*                      10.4 \*  
 10.7 \*                      10.4 \*                      10.3 \*                      10.0 ←                      10.7 \*  
 beste Teiler 60.1 (10.) 63.2 (4.) 73.4 (6.)  
 Trefferlage 0.11 mm rechts, 0.48 mm hoch  
 Streuwert 1.02, horizontal: 1.23, vertikal: 0.74

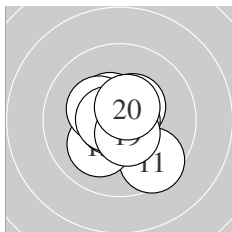

Serie 2:  
 9.5 ↘                      10.4 \*                      10.7 \*                      10.5 \*                      10.1 ↙  
 10.3 \*                      10.7 \*                      10.6 \*                      10.5 \*                      10.5 \*  
 beste Teiler 53.1 (13.) 59.2 (17.) 78.3 (18.)  
 Trefferlage 0.00 mm , 0.17 mm tief  
 Streuwert 1.20, horizontal: 1.14, vertikal: 1.25

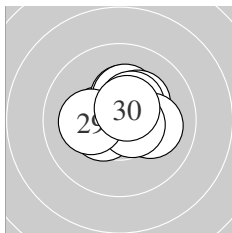

Serie 3:  
 10.4 \*                      10.3 \*                      10.3 \*                      10.3 \*                      10.4 \*  
 10.1 →                      10.5 \*                      10.6 \*                      10.2 \*                      10.6 \*  
 beste Teiler 93.6 (28.) 95.7 (30.) 124.3 (27.)  
 Trefferlage 0.16 mm rechts, 0.48 mm hoch  
 Streuwert 1.08, horizontal: 1.28, vertikal: 0.84

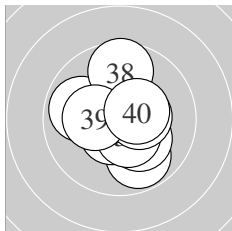

Serie 4:  
 9.8 ↘                      10.5 \*                      10.2 \*                      10.5 \*                      10.5 \*  
 9.9 ←                      10.4 \*                      9.6 ↑                      10.3 \*                      10.4 \*  
 beste Teiler 102.7 (32.) 108.7 (35.) 122.1 (34.)  
 Trefferlage 0.00 mm , 0.06 mm tief  
 Streuwert 1.49, horizontal: 1.41, vertikal: 1.55

Unterschrift des Schützen

Ergebnis: **408.3** (388)  
 Serien: 101.4 102.2 102.7 102.0  
 Zähler: 30 8 2 0 0 0 0 0 0 0  
 Innenzehner: 25  
 weiteste: 634 (9), 508 (18), 440 (23)  
 beste Teiler 18.3 (38.) 49.8 (20.) 51.0 (29.)  
 Trefferlage 0.10 mm links, 0.42 mm hoch  
 Streuwert 1.59, horizontal: 1.92, vertikal: 1.17

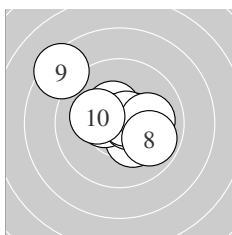
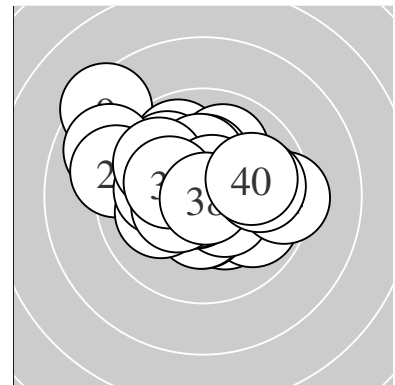

Serie 1:  
 10.4 \*                      10.3 \*                      10.5 \*                      10.6 \*                      10.4 \*  
 10.7 \*                      10.0 →                      9.9 ↘                      8.4 ↖                      10.2 \*  
 beste Teiler 65.7 (6.) 82.2 (4.) 123.7 (3.)  
 Trefferlage 0.01 mm rechts, 0.44 mm hoch  
 Streuwert 1.88, horizontal: 2.17, vertikal: 1.53

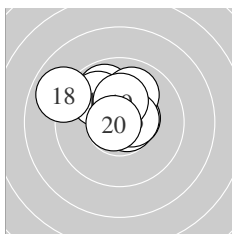

Serie 2:  
 10.5 \*                      9.9 ↖                      10.6 \*                      10.7 \*                      10.0 ↗  
 10.6 \*                      9.9 ↖                      8.9 ↖                      10.3 \*                      10.8 \*  
 beste Teiler 49.8 (20.) 62.8 (14.) 94.8 (13.)  
 Trefferlage 0.34 mm links, 1.13 mm hoch  
 Streuwert 1.47, horizontal: 1.78, vertikal: 1.06

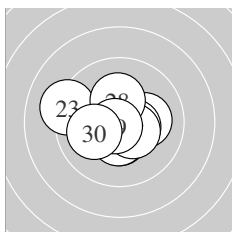

Serie 3:  
 10.1 →                      10.4 \*                      9.2 ↖                      10.7 \*                      10.4 \*  
 10.5 \*                      10.4 \*                      10.2 \*                      10.7 \*                      10.1 ←  
 beste Teiler 51.0 (29.) 55.9 (24.) 117.3 (26.)  
 Trefferlage 0.26 mm links, 0.22 mm tief  
 Streuwert 1.44, horizontal: 1.77, vertikal: 1.01

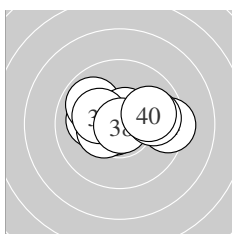

Serie 4:  
 10.1 ←                      10.7 \*                      9.9 ↖                      9.4 →                      10.6 \*  
 10.4 \*                      10.3 \*                      10.9 \*                      9.8 →                      9.9 →  
 beste Teiler 18.3 (38.) 54.9 (32.) 85.2 (35.)  
 Trefferlage 0.20 mm rechts, 0.35 mm hoch  
 Streuwert 1.60, horizontal: 2.17, vertikal: 0.63

Unterschrift des Schützen

Meyton Elektronik



Ergebnis: **411.0** (392)  
 Serien: 100.7 102.9 104.2 103.2  
 Zähler: 32 8 0 0 0 0 0 0 0 0  
 Innenzehner: 27  
 weiteste: 450 (6), 422 (4), 415 (39)  
 beste Teiler 24.3 (21.) 42.9 (26.) 48.3 (28.)  
 Trefferlage 0.06 mm links, 0.30 mm hoch  
 Streuwert 1.43, horizontal: 1.71, vertikal: 1.07

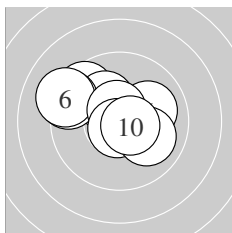
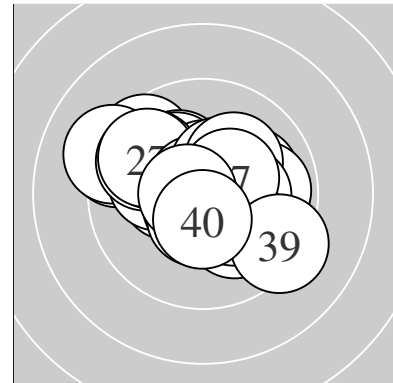

Serie 1:  
 9.6 ↘ 10.2 \* 10.5 \* 9.3 ↘ 10.0 →  
 9.2 ↘ 10.6 \* 10.7 \* 10.0 ↘ 10.6 \*  
 beste Teiler 55.6 (8.) 87.4 (10.) 88.0 (7.)  
 Trefferlage 0.59 mm links, 0.73 mm hoch  
 Streuwert 1.81, horizontal: 2.30, vertikal: 1.13

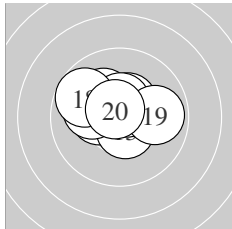

Serie 2:  
 10.2 \* 10.3 \* 10.5 \* 10.1 ↘ 10.6 \*  
 10.4 \* 10.5 \* 9.7 ↘ 9.9 → 10.7 \*  
 beste Teiler 69.4 (20.) 92.0 (15.) 101.0 (13.)  
 Trefferlage 0.34 mm links, 0.65 mm hoch  
 Streuwert 1.22, horizontal: 1.57, vertikal: 0.73

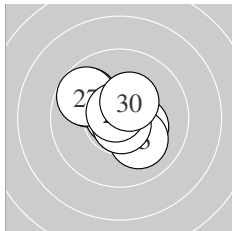

Serie 3:  
 10.9 \* 10.3 \* 10.1 ↘ 9.8 ↘ 10.7 \*  
 10.8 \* 9.7 ↘ 10.8 \* 10.7 \* 10.4 \*  
 beste Teiler 24.3 (21.) 42.9 (26.) 48.3 (28.)  
 Trefferlage 0.19 mm links, 0.26 mm hoch  
 Streuwert 1.21, horizontal: 1.36, vertikal: 1.04

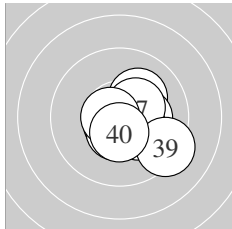

Serie 4:  
 10.1 ↗ 10.2 \* 10.5 \* 10.3 \* 10.7 \*  
 10.5 \* 10.4 \* 10.7 \* 9.3 ↘ 10.5 \*  
 beste Teiler 71.0 (38.) 72.8 (35.) 108.8 (36.)  
 Trefferlage 0.87 mm rechts, 0.41 mm tief  
 Streuwert 1.18, horizontal: 1.29, vertikal: 1.05

Unterschrift des Schützen

Meyton Elektronik

Ergebnis: **418.4** (397)  
 Serien: 105.8 104.5 105.2 102.9  
 Zähler: 37 3 0 0 0 0 0 0 0 0  
 Innenzehner: 34  
 weiteste: 403 (35), 296 (38), 286 (27)  
 beste Teiler 26.4 (7.) 27.6 (4.) 35.6 (6.)  
 Trefferlage 0.02 mm links, 0.17 mm tief  
 Streuwert 1.05, horizontal: 1.11, vertikal: 0.99

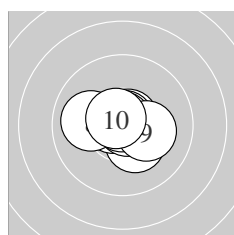
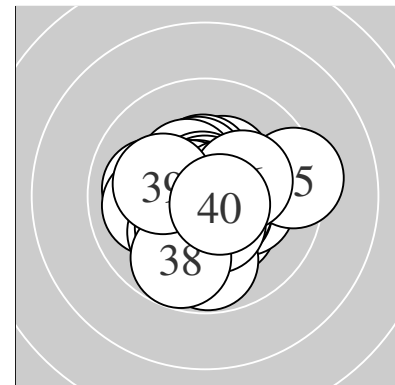

Serie 1:  
 10.3 \*                      10.7 \*                      10.7 \*                      10.8 \*                      10.8 \*  
 10.8 \*                      10.8 \*                      10.0 ←                      10.2 \*                      10.7 \*  
 beste Teiler 26.4 (7.) 27.6 (4.) 35.6 (6.)  
 Trefferlage 0.00 mm , 0.04 mm hoch  
 Streuwert 0.86, horizontal: 1.08, vertikal: 0.54

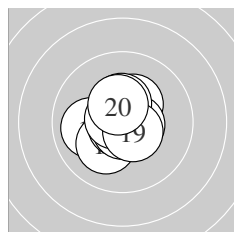

Serie 2:  
 10.0 ←                      10.3 \*                      10.1 ✓                      10.8 \*                      10.6 \*  
 10.7 \*                      10.7 \*                      10.4 \*                      10.5 \*                      10.4 \*  
 beste Teiler 46.0 (14.) 52.0 (16.) 63.6 (17.)  
 Trefferlage 0.25 mm links, 0.04 mm hoch  
 Streuwert 1.00, horizontal: 1.00, vertikal: 1.00

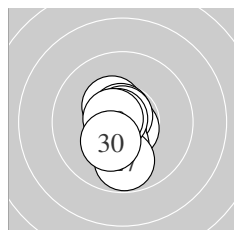

Serie 3:  
 10.7 \*                      10.4 \*                      10.7 \*                      10.8 \*                      10.7 \*  
 10.3 \*                      9.8 ↓                      10.8 \*                      10.7 \*                      10.3 \*  
 beste Teiler 45.0 (24.) 45.4 (28.) 60.0 (25.)  
 Trefferlage 0.30 mm links, 0.39 mm tief  
 Streuwert 0.93, horizontal: 0.43, vertikal: 1.24

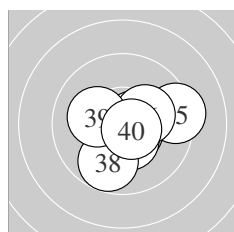

Serie 4:  
 10.6 \*                      10.6 \*                      10.4 \*                      10.6 \*                      9.3 →  
 10.2 \*                      10.6 \*                      9.8 ↓                      10.2 \*                      10.6 \*  
 beste Teiler 76.1 (40.) 77.8 (37.) 87.3 (34.)  
 Trefferlage 0.45 mm rechts, 0.41 mm tief  
 Streuwert 1.37, horizontal: 1.61, vertikal: 1.07

Unterschrift des Schützen

Meyton Elektronik

Ergebnis: **413.7** (397)  
 Serien: 100.5 104.5 104.5 104.2  
 Zähler: 37 3 0 0 0 0 0 0 0 0  
 Innenzehner: 29  
 weiteste: 453 (2), 344 (6), 331 (30)  
 beste Teiler 20.8 (16.) 39.6 (24.) 48.0 (40.)  
 Trefferlage 0.20 mm rechts, 0.08 mm hoch  
 Streuwert 1.26, horizontal: 1.62, vertikal: 0.75

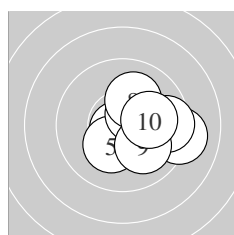
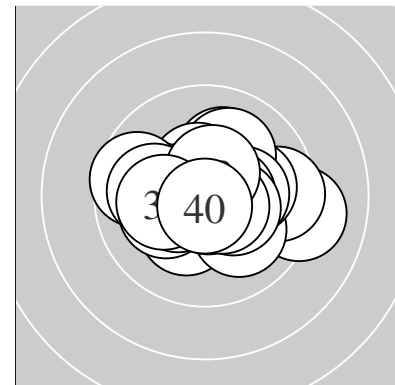

Serie 1:  
 10.1 →                      9.1 →                      10.0 →                      10.8 \*                      10.2 \*  
 9.6 →                      10.5 \*                      10.1 ↑                      10.0 ↘                      10.1 →  
 beste Teiler 50.9 (4.) 123.0 (7.) 176.1 (5.)  
 Trefferlage 1.66 mm rechts, 0.13 mm tief  
 Streuwert 1.38, horizontal: 1.63, vertikal: 1.07

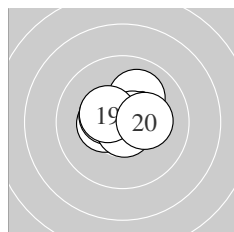

Serie 2:  
 10.3 \*                      10.4 \*                      10.1 ↗                      10.4 \*                      10.4 \*  
 10.9 \*                      10.6 \*                      10.7 \*                      10.4 \*                      10.3 \*  
 beste Teiler 20.8 (16.) 54.1 (18.) 79.8 (17.)  
 Trefferlage 0.27 mm rechts, 0.37 mm hoch  
 Streuwert 0.95, horizontal: 1.16, vertikal: 0.68

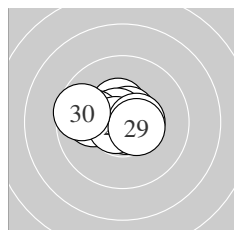

Serie 3:  
 10.4 \*                      10.7 \*                      10.6 \*                      10.8 \*                      10.7 \*  
 10.0 ←                      10.7 \*                      10.5 \*                      10.5 \*                      9.6 ←  
 beste Teiler 39.6 (24.) 57.7 (27.) 62.2 (25.)  
 Trefferlage 0.47 mm links, 0.27 mm hoch  
 Streuwert 1.04, horizontal: 1.39, vertikal: 0.51

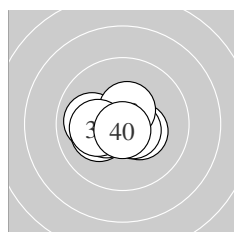

Serie 4:  
 10.3 \*                      10.4 \*                      10.0 ←                      10.8 \*                      10.2 \*  
 10.4 \*                      10.6 \*                      10.5 \*                      10.2 \*                      10.8 \*  
 beste Teiler 48.0 (40.) 50.9 (34.) 93.8 (37.)  
 Trefferlage 0.63 mm links, 0.16 mm tief  
 Streuwert 1.03, horizontal: 1.34, vertikal: 0.56

Unterschrift des Schützen

Meyton Elektronik

Ergebnis: **412.4** (395)  
 Serien: 103.5 102.6 102.8 103.5  
 Zähler: 35 5 0 0 0 0 0 0 0 0  
 Innenzehner: 29  
 weiteste: 386 (37), 284 (27), 268 (18)  
 beste Teiler 44.2 (22.) 47.0 (6.) 51.4 (38.)  
 Trefferlage 0.14 mm links, 0.32 mm tief  
 Streuwert 1.24, horizontal: 1.35, vertikal: 1.13

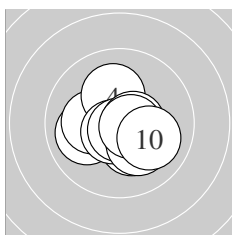
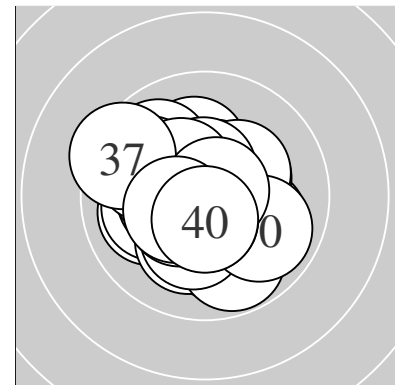

Serie 1:  
 10.3 \*                      10.0 ←                      10.2 \*                      10.2 \*                      10.6 \*  
 10.8 \*                      10.2 \*                      10.6 \*                      10.6 \*                      10.0 ↘  
 beste Teiler 47.0 (6.) 78.2 (5.) 82.5 (9.)  
 Trefferlage 0.08 mm rechts, 0.39 mm tief  
 Streuwert 1.20, horizontal: 1.38, vertikal: 0.98

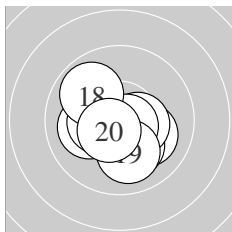

Serie 2:  
 10.1 ↘                      10.1 ←                      10.4 \*                      10.3 \*                      10.2 \*  
 10.4 \*                      10.7 \*                      9.9 ↘                      10.0 ↓                      10.5 \*  
 beste Teiler 63.7 (17.) 103.2 (20.) 131.2 (16.)  
 Trefferlage 0.04 mm links, 0.67 mm tief  
 Streuwert 1.28, horizontal: 1.42, vertikal: 1.12

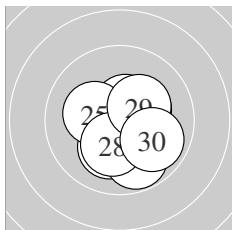

Serie 3:  
 10.7 \*                      10.8 \*                      10.5 \*                      10.1 ↓                      10.2 \*  
 10.3 \*                      9.8 ↓                      10.2 \*                      10.3 \*                      9.9 ↘  
 beste Teiler 44.2 (22.) 67.0 (21.) 105.3 (23.)  
 Trefferlage 0.33 mm rechts, 0.40 mm tief  
 Streuwert 1.29, horizontal: 1.21, vertikal: 1.36

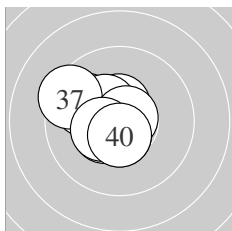

Serie 4:  
 10.5 \*                      9.9 ↘                      10.6 \*                      10.4 \*                      10.6 \*  
 10.4 \*                      9.4 ↘                      10.7 \*                      10.4 \*                      10.6 \*  
 beste Teiler 51.4 (38.) 85.7 (33.) 97.0 (35.)  
 Trefferlage 0.96 mm links, 0.17 mm hoch  
 Streuwert 1.11, horizontal: 1.21, vertikal: 0.99

Unterschrift des Schützen

Meyton Elektronik

Ergebnis: **417.5** (397)  
 Serien: 105.1 104.2 104.4 103.8  
 Zähler: 37 3 0 0 0 0 0 0 0 0  
 Innenzehner: 35  
 weiteste: 424 (30), 307 (36), 254 (14)  
 beste Teiler 9.0 (12.) 16.1 (7.) 23.2 (33.)  
 Trefferlage 0.40 mm links, 0.14 mm tief  
 Streuwert 1.07, horizontal: 1.31, vertikal: 0.75

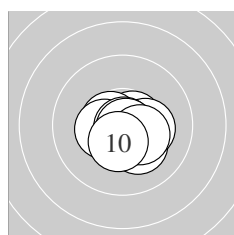
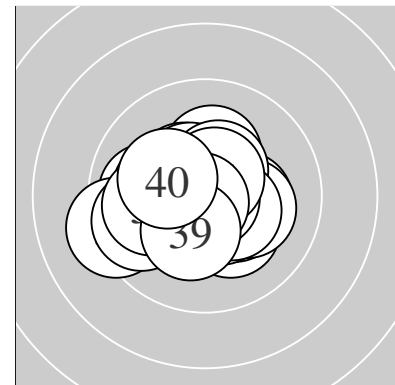

Serie 1:  
 10.5 \*                      10.2 \*                      10.6 \*                      10.3 \*                      10.6 \*  
 10.4 \*                      10.9 \*                      10.8 \*                      10.4 \*                      10.4 \*  
 beste Teiler 16.1 (7.) 33.9 (8.) 81.1 (3.)  
 Trefferlage 0.35 mm rechts, 0.41 mm tief  
 Streuwert 0.81, horizontal: 0.99, vertikal: 0.57

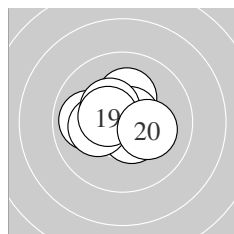

Serie 2:  
 10.7 \*                      10.9 \*                      10.2 \*                      9.9 ←                      10.7 \*  
 10.5 \*                      10.2 \*                      10.4 \*                      10.5 \*                      10.2 \*  
 beste Teiler 9.0 (12.) 66.8 (15.) 71.5 (11.)  
 Trefferlage 0.24 mm links, 0.19 mm hoch  
 Streuwert 1.10, horizontal: 1.34, vertikal: 0.79

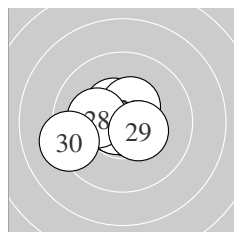

Serie 3:  
 10.8 \*                      10.7 \*                      10.7 \*                      10.6 \*                      10.8 \*  
 10.5 \*                      10.4 \*                      10.2 \*                      10.4 \*                      9.3 ←  
 beste Teiler 45.6 (21.) 48.4 (25.) 53.6 (23.)  
 Trefferlage 0.68 mm links, 0.02 mm hoch  
 Streuwert 1.16, horizontal: 1.46, vertikal: 0.76

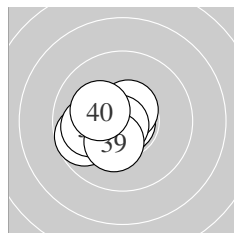

Serie 4:  
 10.8 \*                      10.1 ←                      10.9 \*                      10.4 \*                      10.6 \*  
 9.7 ←                      10.0 ←                      10.8 \*                      10.3 \*                      10.2 \*  
 beste Teiler 23.2 (33.) 40.3 (38.) 41.2 (31.)  
 Trefferlage 1.04 mm links, 0.40 mm tief  
 Streuwert 0.98, horizontal: 1.15, vertikal: 0.77

Unterschrift des Schützen

Ergebnis: **414.1** (396)  
 Serien: 104.2 103.1 103.4 103.4  
 Zähler: 36 4 0 0 0 0 0 0 0 0  
 Innenzehner: 29  
 weiteste: 380 (26), 347 (19), 292 (35)  
 beste Teiler 21.9 (33.) 29.1 (3.) 30.4 (18.)  
 Trefferlage 0.71 mm links, 0.47 mm tief  
 Streuwert 1.05, horizontal: 1.25, vertikal: 0.79

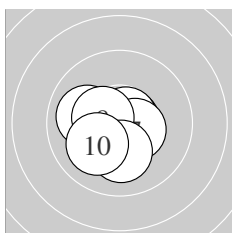
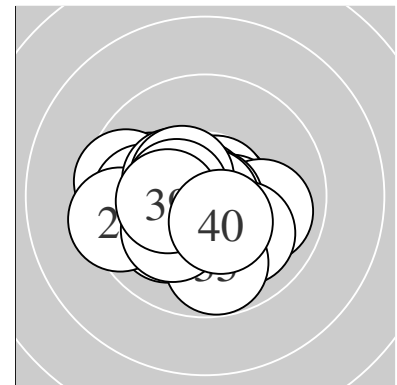

Serie 1:  
 10.7 \*                      10.0 ←                      10.8 \*                      10.7 \*                      10.5 \*  
 10.4 \*                      10.5 \*                      10.4 \*                      10.1 ↓                      10.1 ↙  
 beste Teiler 29.1 (3.) 57.6 (4.) 65.7 (1.)  
 Trefferlage 0.51 mm links, 0.37 mm tief  
 Streuwert 0.98, horizontal: 1.09, vertikal: 0.85

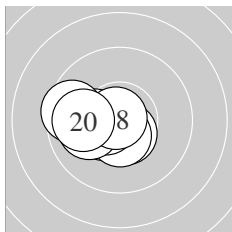

Serie 2:  
 10.5 \*                      10.5 \*                      10.6 \*                      10.2 \*                      10.5 \*  
 10.5 \*                      10.0 ←                      10.8 \*                      9.6 ←                      9.9 ←  
 beste Teiler 30.4 (18.) 96.7 (13.) 102.3 (16.)  
 Trefferlage 1.28 mm links, 0.29 mm tief  
 Streuwert 0.95, horizontal: 1.22, vertikal: 0.54

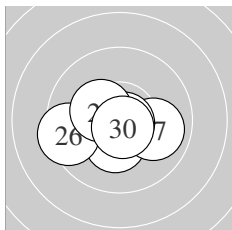

Serie 3:  
 10.4 \*                      10.4 \*                      10.4 \*                      10.6 \*                      10.3 \*  
 9.4 ←                      10.0 →                      10.8 \*                      10.4 \*                      10.7 \*  
 beste Teiler 34.8 (28.) 56.4 (30.) 86.8 (24.)  
 Trefferlage 0.62 mm links, 0.51 mm tief  
 Streuwert 1.19, horizontal: 1.55, vertikal: 0.67

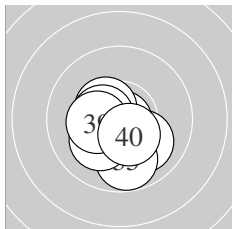

Serie 4:  
 10.0 ↘                      10.4 \*                      10.9 \*                      10.6 \*                      9.8 ↓  
 10.4 \*                      10.5 \*                      10.1 ↗                      10.3 \*                      10.4 \*  
 beste Teiler 21.9 (33.) 94.3 (34.) 124.7 (37.)  
 Trefferlage 0.44 mm links, 0.71 mm tief  
 Streuwert 1.08, horizontal: 1.10, vertikal: 1.07

Unterschrift des Schützen

Meyton Elektronik

Ergebnis: **418.1** (396)  
 Serien: 104.5 105.4 105.4 102.8  
 Zähler: 36 4 0 0 0 0 0 0 0 0  
 Innenzehner: 34  
 weiteste: 329 (37), 328 (9), 291 (22)  
 beste Teiler 26.0 (17.) 33.1 (11.) 36.7 (33.)  
 Trefferlage 0.14 mm rechts, 0.27 mm hoch  
 Streuwert 1.03, horizontal: 1.26, vertikal: 0.73

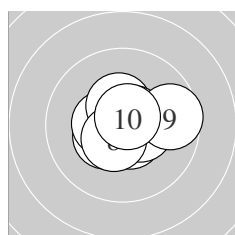
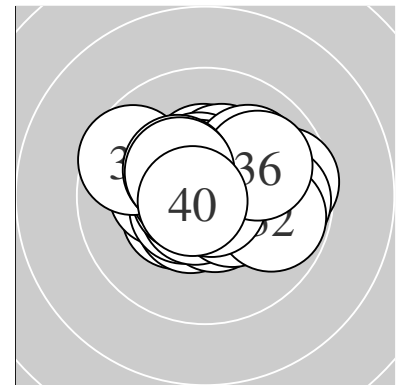

Serie 1:  
 10.7 \*                      10.4 \*                      10.6 \*                      10.5 \*                      10.4 \*  
 10.6 \*                      10.5 \*                      10.5 \*                      9.6 →                      10.7 \*  
 beste Teiler 66.7 (10.) 66.8 (1.) 85.1 (6.)  
 Trefferlage 0.23 mm rechts, 0.08 mm hoch  
 Streuwert 1.07, horizontal: 1.32, vertikal: 0.73

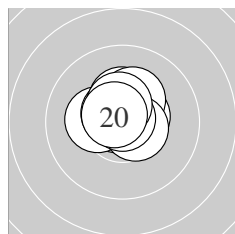

Serie 2:  
 10.8 \*                      10.3 \*                      10.3 \*                      10.5 \*                      10.3 \*  
 10.6 \*                      10.8 \*                      10.6 \*                      10.5 \*                      10.7 \*  
 beste Teiler 26.0 (17.) 33.1 (11.) 75.0 (20.)  
 Trefferlage 0.09 mm links, 0.58 mm hoch  
 Streuwert 0.73, horizontal: 0.81, vertikal: 0.63

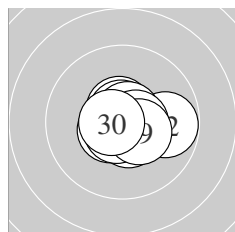

Serie 3:  
 10.6 \*                      9.8 →                      10.6 \*                      10.7 \*                      10.7 \*  
 10.6 \*                      10.6 \*                      10.7 \*                      10.4 \*                      10.7 \*  
 beste Teiler 61.2 (25.) 62.8 (24.) 69.6 (28.)  
 Trefferlage 0.33 mm rechts, 0.09 mm tief  
 Streuwert 0.89, horizontal: 1.11, vertikal: 0.59

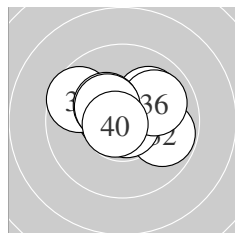

Serie 4:  
 10.6 \*                      9.8 →                      10.8 \*                      10.6 \*                      10.0 ↗  
 10.0 ↗                      9.6 ↖                      10.3 \*                      10.4 \*                      10.7 \*  
 beste Teiler 36.7 (33.) 55.1 (40.) 80.3 (31.)  
 Trefferlage 0.12 mm rechts, 0.53 mm hoch  
 Streuwert 1.37, horizontal: 1.75, vertikal: 0.82

Unterschrift des Schützen

Ergebnis: **413.3** (395)  
 Serien: 101.9 103.8 104.3 103.3  
 Zähler: 35 5 0 0 0 0 0 0 0 0  
 Innenzehner: 31  
 weiteste: 414 (27), 336 (17), 335 (10)  
 beste Teiler 11.4 (29.) 25.4 (38.) 31.0 (30.)  
 Trefferlage 0.40 mm links, 0.38 mm tief  
 Streuwert 1.20, horizontal: 1.21, vertikal: 1.19

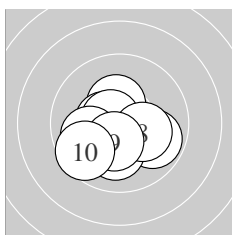
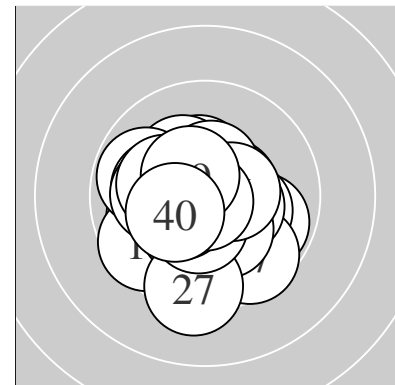

Serie 1:  
 10.4 \*                      9.8 ↘                      10.2 \*                      10.1 ↓                      10.5 \*  
 10.7 \*                      10.0 ←                      10.2 \*                      10.4 \*                      9.6 ↙  
 beste Teiler 73.9 (6.) 115.1 (5.) 143.9 (9.)  
 Trefferlage 0.43 mm links, 0.79 mm tief  
 Streuwert 1.37, horizontal: 1.57, vertikal: 1.13

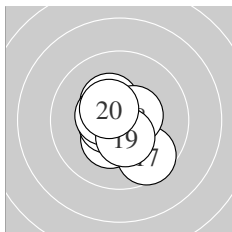

Serie 2:  
 10.5 \*                      10.3 \*                      10.6 \*                      10.3 \*                      10.6 \*  
 10.5 \*                      9.6 ↘                      10.5 \*                      10.4 \*                      10.5 \*  
 beste Teiler 85.5 (13.) 92.0 (15.) 106.0 (11.)  
 Trefferlage 0.12 mm links, 0.45 mm tief  
 Streuwert 1.12, horizontal: 1.03, vertikal: 1.20

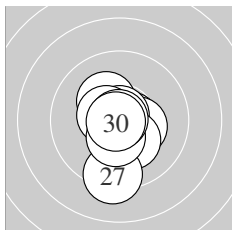

Serie 3:  
 10.3 \*                      10.6 \*                      10.4 \*                      10.8 \*                      10.5 \*  
 10.3 \*                      9.3 ↓                      10.4 \*                      10.9 \*                      10.8 \*  
 beste Teiler 11.4 (29.) 31.0 (30.) 37.0 (24.)  
 Trefferlage 0.01 mm links, 0.53 mm tief  
 Streuwert 1.21, horizontal: 0.80, vertikal: 1.51

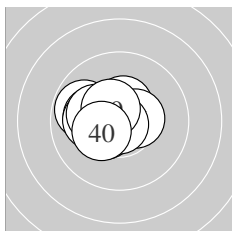

Serie 4:  
 9.8 ↙                      10.1 ←                      10.1 ←                      10.2 \*                      10.5 \*  
 10.5 \*                      10.4 \*                      10.9 \*                      10.5 \*                      10.3 \*  
 beste Teiler 25.4 (38.) 115.2 (39.) 119.5 (36.)  
 Trefferlage 1.03 mm links, 0.24 mm hoch  
 Streuwert 0.98, horizontal: 1.21, vertikal: 0.66

Unterschrift des Schützen

Meyton Elektronik



Ergebnis: **409.0** (393)  
 Serien: 101.2 101.9 103.7 102.2  
 Zähler: 34 5 1 0 0 0 0 0 0  
 Innenzehner: 27  
 weiteste: 563 (1), 395 (38), 393 (15)  
 beste Teiler 23.4 (23.) 48.4 (10.) 52.8 (21.)  
 Trefferlage 0.73 mm rechts, 0.59 mm tief  
 Streuwert 1.34, horizontal: 1.65, vertikal: 0.91

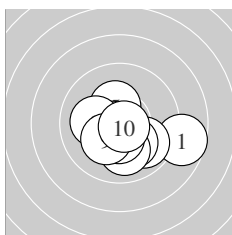
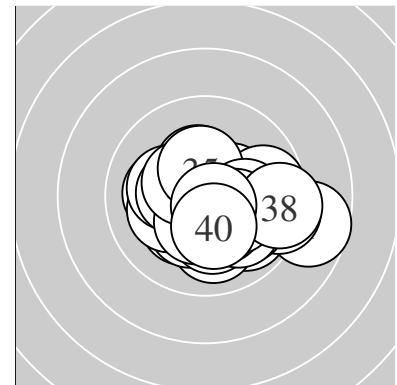

Serie 1:  
 8.7 →                      9.9 ↘                      10.1 ↘                      10.0 ↓                      10.3 \*  
 10.7 \*                      10.4 \*                      10.1 ←                      10.2 \*                      10.8 \*  
 beste Teiler 48.4 (10.) 74.2 (6.) 130.1 (7.)  
 Trefferlage 0.51 mm rechts, 0.88 mm tief  
 Streuwert 1.68, horizontal: 2.09, vertikal: 1.13

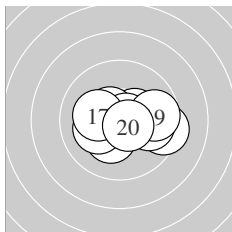

Serie 2:  
 10.3 \*                      10.4 \*                      10.5 \*                      10.2 \*                      9.4 →  
 10.7 \*                      10.2 \*                      9.9 →                      9.7 →                      10.6 \*  
 beste Teiler 56.2 (16.) 89.0 (20.) 108.2 (13.)  
 Trefferlage 0.67 mm rechts, 0.18 mm tief  
 Streuwert 1.52, horizontal: 2.03, vertikal: 0.72

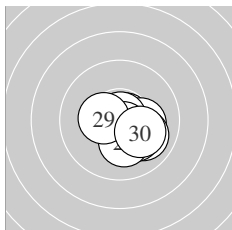

Serie 3:  
 10.7 \*                      10.2 \*                      10.9 \*                      10.0 ↘                      10.3 \*  
 10.7 \*                      10.2 \*                      10.2 \*                      10.4 \*                      10.1 ↘  
 beste Teiler 23.4 (23.) 52.8 (21.) 70.6 (26.)  
 Trefferlage 0.81 mm rechts, 0.71 mm tief  
 Streuwert 0.91, horizontal: 1.05, vertikal: 0.74

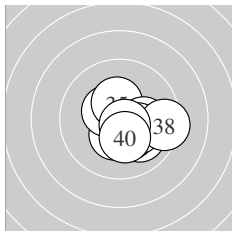

Serie 4:  
 10.4 \*                      10.0 ↘                      10.4 \*                      10.3 \*                      10.4 \*  
 10.1 →                      10.2 \*                      9.4 →                      10.7 \*                      10.3 \*  
 beste Teiler 68.7 (39.) 129.5 (33.) 141.9 (31.)  
 Trefferlage 0.93 mm rechts, 0.57 mm tief  
 Streuwert 1.25, horizontal: 1.46, vertikal: 0.99

Unterschrift des Schützen

Meyton Elektronik

Ergebnis: **413.2** (395)

Serien: 103.8 103.7 102.9 102.8

Zähler: 35 5 0 0 0 0 0 0 0 0

Innenzehner: 29

weiteste: 314 (28), 296 (38), 295 (9)

beste Teiler 3.1 (1.) 27.2 (2.) 43.6 (14.)

Trefferlage 0.28 mm rechts, 0.41 mm hoch

Streuwert 1.18, horizontal: 1.32, vertikal: 1.03

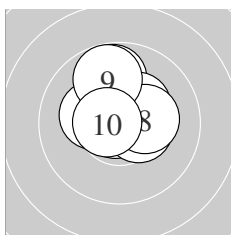
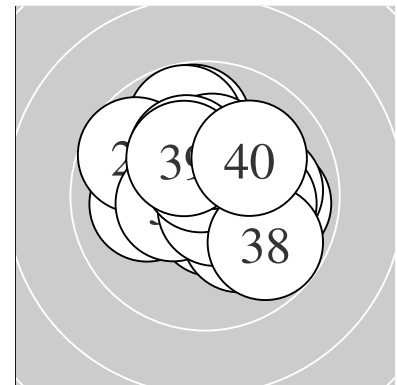

Serie 1:

10.9 *	10.8 *	10.7 *	10.2 *	10.4 *
9.8 ↑	10.3 *	10.3 *	9.8 ↑	10.6 *

beste Teiler 3.1 (1.) 27.2 (2.) 68.5 (3.)

Trefferlage 0.03 mm links, 0.79 mm hoch

Streuwert 1.10, horizontal: 1.05, vertikal: 1.16

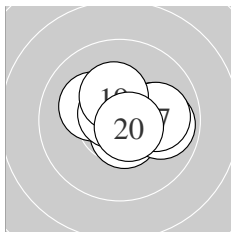

Serie 2:

10.6 *	10.1 →	10.2 *	10.8 *	10.4 *
9.9 →	10.0 →	10.7 *	10.3 *	10.7 *

beste Teiler 43.6 (14.) 63.7 (18.) 73.8 (20.)

Trefferlage 0.73 mm rechts, 0.16 mm hoch

Streuwert 1.11, horizontal: 1.40, vertikal: 0.69

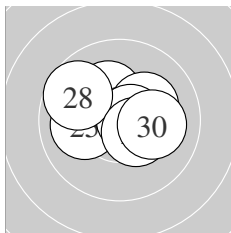

Serie 3:

10.6 *	10.5 *	10.2 *	10.5 *	10.0 ←
10.2 *	10.7 *	9.7 ↖	10.4 *	10.1 →

beste Teiler 72.3 (27.) 99.3 (21.) 107.8 (22.)

Trefferlage 0.11 mm rechts, 0.27 mm hoch

Streuwert 1.31, horizontal: 1.66, vertikal: 0.83

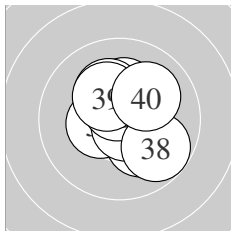

Serie 4:

10.1 ↘	10.5 *	10.4 *	10.7 *	10.6 *
10.2 *	10.2 *	9.8 ↘	10.3 *	10.0 ↗

beste Teiler 62.4 (34.) 84.5 (35.) 120.8 (32.)

Trefferlage 0.33 mm rechts, 0.42 mm hoch

Streuwert 1.26, horizontal: 1.16, vertikal: 1.35

Unterschrift des Schützen

Meyton Elektronik

Ergebnis: **412.3** (390)  
 Serien: 103.4 103.3 100.7 104.9  
 Zähler: 30 10 0 0 0 0 0 0 0 0  
 Innenzehner: 27  
 weiteste: 444 (22), 392 (21), 376 (26)  
 beste Teiler 8.0 (5.) 31.6 (14.) 42.0 (17.)  
 Trefferlage 0.38 mm rechts, 0.01 mm tief  
 Streuwert 1.38, horizontal: 1.65, vertikal: 1.05

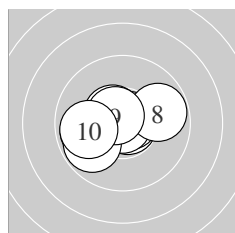
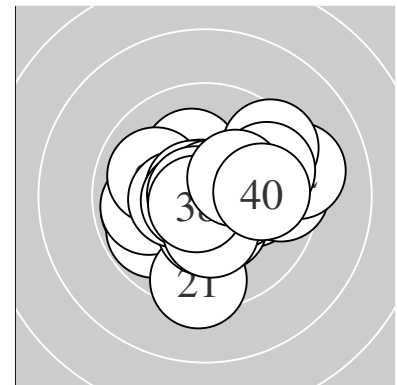

Serie 1:  
 10.5 \*                      10.8 \*                      10.5 \*                      10.7 \*                      10.9 \*  
 9.9 ←                      9.8 ↙                      9.8 →                      10.6 \*                      9.9 ←  
 beste Teiler 8.0 (5.) 43.8 (2.) 58.5 (4.)  
 Trefferlage 0.63 mm links, 0.04 mm tief  
 Streuwert 1.29, horizontal: 1.67, vertikal: 0.72

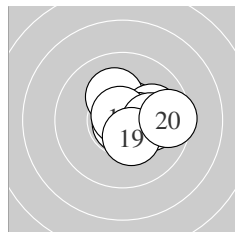

Serie 2:  
 10.6 \*                      10.4 \*                      10.2 \*                      10.8 \*                      10.0 →  
 10.5 \*                      10.8 \*                      10.1 →                      10.4 \*                      9.5 →  
 beste Teiler 31.6 (14.) 42.0 (17.) 95.8 (11.)  
 Trefferlage 1.07 mm rechts, 0.20 mm hoch  
 Streuwert 1.07, horizontal: 1.29, vertikal: 0.80

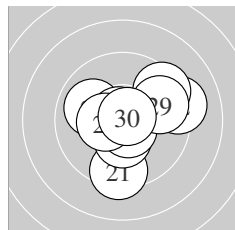

Serie 3:  
 9.4 ↓                      9.2 →                      10.4 \*                      10.6 \*                      10.0 ↖  
 9.4 ↗                      10.8 \*                      10.4 \*                      9.7 →                      10.8 \*  
 beste Teiler 44.8 (30.) 46.6 (27.) 79.6 (24.)  
 Trefferlage 0.67 mm rechts, 0.00 mm  
 Streuwert 1.91, horizontal: 2.08, vertikal: 1.72

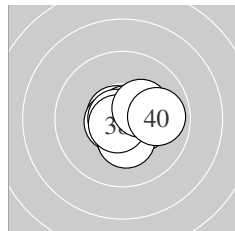

Serie 4:  
 10.7 \*                      10.6 \*                      10.4 \*                      10.4 \*                      10.8 \*  
 10.8 \*                      10.3 \*                      10.7 \*                      10.3 \*                      9.9 →  
 beste Teiler 44.8 (35.) 45.3 (36.) 54.4 (38.)  
 Trefferlage 0.41 mm rechts, 0.20 mm tief  
 Streuwert 0.94, horizontal: 1.09, vertikal: 0.75

Unterschrift des Schützen

Meyton Elektronik

Ergebnis: **418.8** (399)  
 Serien: 106.5 103.8 105.0 103.5  
 Zähler: 39 1 0 0 0 0 0 0 0 0  
 Innenzehner: 34  
 weiteste: 255 (31), 246 (29), 243 (38)  
 beste Teiler 13.3 (9.) 19.4 (5.) 27.3 (24.)  
 Trefferlage 0.10 mm links, 0.18 mm tief  
 Streuwert 0.97, horizontal: 1.14, vertikal: 0.75

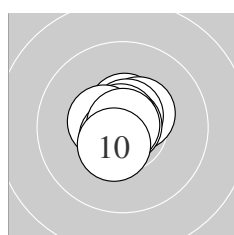
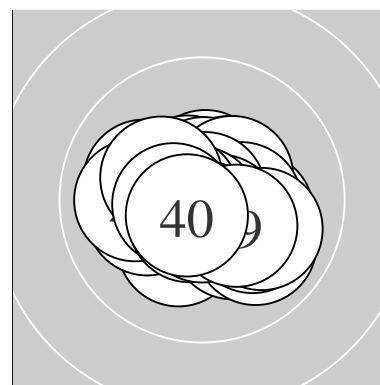

Serie 1:  
 10.5 \*                      10.4 \*                      10.6 \*                      10.7 \*                      10.9 \*  
 10.8 \*                      10.5 \*                      10.7 \*                      10.9 \*                      10.5 \*  
 beste Teiler 13.3 (9.) 19.4 (5.) 42.7 (6.)  
 Trefferlage 0.16 mm links, 0.21 mm hoch  
 Streuwert 0.64, horizontal: 0.63, vertikal: 0.65

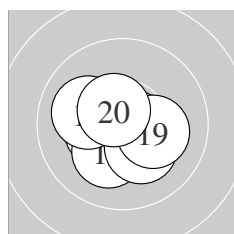

Serie 2:  
 10.6 \*                      10.4 \*                      10.6 \*                      10.4 \*                      10.2 \*  
 10.6 \*                      10.1 ←                      10.2 \*                      10.2 \*                      10.5 \*  
 beste Teiler 84.4 (16.) 96.1 (13.) 100.6 (11.)  
 Trefferlage 0.34 mm links, 0.26 mm tief  
 Streuwert 1.08, horizontal: 1.24, vertikal: 0.89

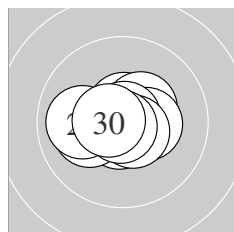

Serie 3:  
 10.6 \*                      10.4 \*                      10.4 \*                      10.8 \*                      10.7 \*  
 10.6 \*                      10.1 ←                      10.8 \*                      10.0 ←                      10.6 \*  
 beste Teiler 27.3 (24.) 30.8 (28.) 67.0 (25.)  
 Trefferlage 0.23 mm links, 0.01 mm tief  
 Streuwert 0.96, horizontal: 1.25, vertikal: 0.53

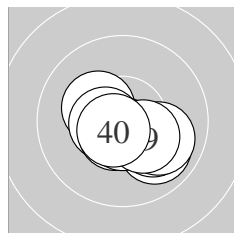

Serie 4:  
 9.9 ↘                      10.6 \*                      10.3 \*                      10.5 \*                      10.6 \*  
 10.6 \*                      10.1 ↘                      10.0 ↘                      10.3 \*                      10.6 \*  
 beste Teiler 79.0 (36.) 79.9 (40.) 83.2 (32.)  
 Trefferlage 0.30 mm rechts, 0.67 mm tief  
 Streuwert 1.08, horizontal: 1.38, vertikal: 0.66

Unterschrift des Schützen