

Ergebnis: **416.9** (397)  
 Serien: 103.3 103.9 106.4 103.3  
 Zähler: 37 3 0 0 0 0 0 0 0 0  
 Innenzehner: 33  
 weiteste: 345 (8), 294 (39), 283 (33)  
 beste Teiler 12.0 (2.) 24.0 (29.) 32.0 (30.)  
 Trefferlage 0.11 mm rechts, 0.04 mm tief  
 Streuwert 1.10, horizontal: 1.08, vertikal: 1.12

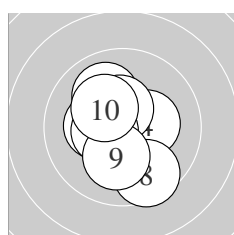

Serie 1:  
 10.7 \*                    10.9 \*                    10.3 \*                    10.3 \*                    10.0 ↗  
 10.5 \*                    10.5 \*                    9.6 ↘                    10.2 \*                    10.3 \*  
 beste Teiler 12.0 (2.) 69.4 (1.) 122.5 (7.)  
 Trefferlage 0.33 mm links, 0.01 mm tief  
 Streuwert 1.34, horizontal: 1.14, vertikal: 1.52

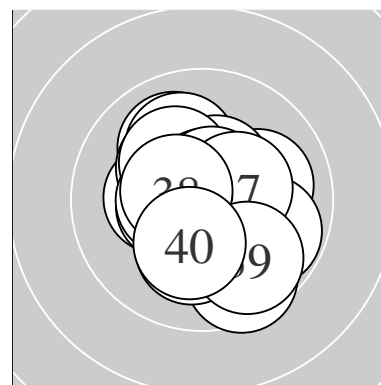
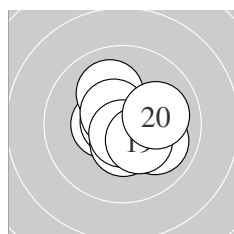

Serie 2:  
 10.5 \*                    10.7 \*                    10.5 \*                    10.1 ↗                    10.5 \*  
 10.0 ↘                    10.6 \*                    10.7 \*                    10.3 \*                    10.0 →  
 beste Teiler 60.8 (12.) 63.0 (18.) 96.2 (17.)  
 Trefferlage 0.34 mm rechts, 0.07 mm tief  
 Streuwert 1.14, horizontal: 1.24, vertikal: 1.02

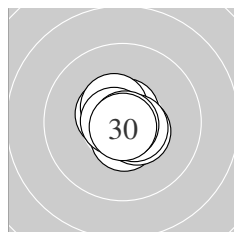

Serie 3:  
 10.7 \*                    10.7 \*                    10.5 \*                    10.5 \*                    10.5 \*  
 10.7 \*                    10.5 \*                    10.6 \*                    10.9 \*                    10.8 \*  
 beste Teiler 24.0 (29.) 32.0 (30.) 57.4 (26.)  
 Trefferlage 0.07 mm rechts, 0.06 mm tief  
 Streuwert 0.62, horizontal: 0.62, vertikal: 0.63

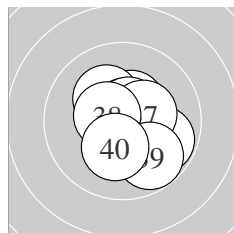

Serie 4:  
 10.4 \*                    10.2 \*                    9.8 ↘                    10.7 \*                    10.7 \*  
 10.6 \*                    10.4 \*                    10.5 \*                    9.8 ↘                    10.2 \*  
 beste Teiler 63.5 (34.) 66.7 (35.) 79.2 (36.)  
 Trefferlage 0.35 mm rechts, 0.03 mm tief  
 Streuwert 1.26, horizontal: 1.24, vertikal: 1.28

Unterschrift des Schützen

Meyton Elektronik

Ergebnis: **404.2** (387)  
 Serien: 100.8 101.8 100.7 100.9  
 Zähler: 28 11 1 0 0 0 0 0 0 0  
 Innenzehner: 21  
 weiteste: 629 (30), 410 (12), 390 (35)  
 beste Teiler 31.1 (13.) 62.8 (18.) 65.0 (22.)  
 Trefferlage 0.52 mm links, 0.18 mm hoch  
 Streuwert 1.68, horizontal: 1.95, vertikal: 1.36

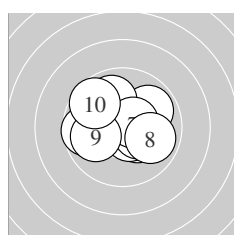
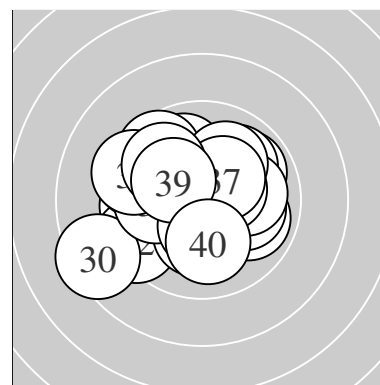

Serie 1:  
 10.3 \*                      9.7 ←                      9.9 ↗                      10.6 \*                      9.9 ↖  
 10.3 \*                      10.5 \*                      9.9 →                      10.0 ←                      9.7 ↘  
 beste Teiler 99.0 (4.) 101.6 (7.) 153.0 (6.)  
 Trefferlage 0.00 mm , 0.20 mm hoch  
 Streuwert 1.73, horizontal: 2.08, vertikal: 1.30

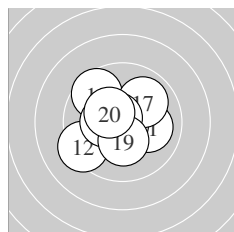

Serie 2:  
 10.1 →                      9.3 ↙                      10.8 \*                      10.3 \*                      9.6 ↖  
 10.3 \*                      10.0 ↗                      10.7 \*                      10.3 \*                      10.4 \*  
 beste Teiler 31.1 (13.) 62.8 (18.) 144.0 (20.)  
 Trefferlage 0.62 mm links, 0.16 mm hoch  
 Streuwert 1.59, horizontal: 1.74, vertikal: 1.41

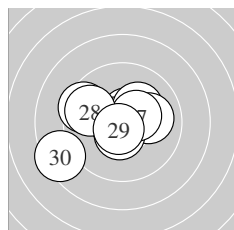

Serie 3:  
 10.6 \*                      10.7 \*                      10.2 \*                      10.0 →                      9.5 ↖  
 10.5 \*                      10.4 \*                      9.7 ←                      10.7 \*                      8.4 ←  
 beste Teiler 65.0 (22.) 70.3 (29.) 85.0 (21.)  
 Trefferlage 0.79 mm links, 0.05 mm hoch  
 Streuwert 1.97, horizontal: 2.44, vertikal: 1.33

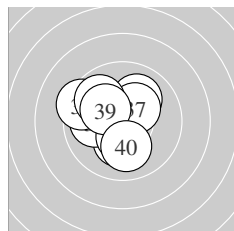

Serie 4:  
 10.2 \*                      10.4 \*                      10.0 ←                      10.4 \*                      9.4 ↖  
 10.0 ↗                      10.3 \*                      9.9 ↘                      10.2 \*                      10.1 ↓  
 beste Teiler 138.4 (34.) 148.5 (32.) 158.4 (37.)  
 Trefferlage 0.67 mm links, 0.32 mm hoch  
 Streuwert 1.61, horizontal: 1.65, vertikal: 1.58

Unterschrift des Schützen

Meyton Elektronik

Ergebnis: **416.7** (398)  
 Serien: 105.7 102.4 103.0 105.6  
 Zähler: 38 2 0 0 0 0 0 0 0 0  
 Innenzehner: 33  
 weiteste: 291 (19), 251 (23), 250 (20)  
 beste Teiler 17.4 (14.) 43.6 (4.) 52.8 (28.)  
 Trefferlage 0.29 mm links, 0.20 mm tief  
 Streuwert 1.05, horizontal: 1.17, vertikal: 0.91

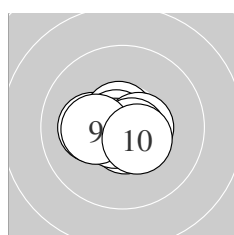
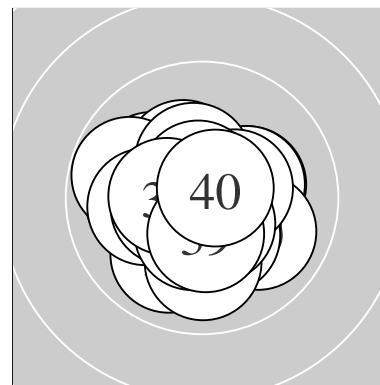

Serie 1:  
 10.2 \*                      10.7 \*                      10.7 \*                      10.8 \*                      10.6 \*  
 10.7 \*                      10.5 \*                      10.7 \*                      10.3 \*                      10.5 \*  
 beste Teiler 43.6 (4.) 57.8 (2.) 62.6 (6.)  
 Trefferlage 0.23 mm links, 0.11 mm tief  
 Streuwert 0.78, horizontal: 0.99, vertikal: 0.48

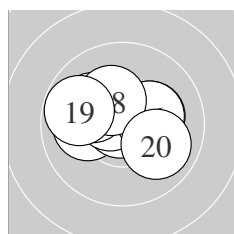

Serie 2:  
 10.2 \*                      10.2 \*                      10.1 ←                      10.9 \*                      10.6 \*  
 10.2 \*                      10.1 ↖                      10.3 \*                      9.8 ↖                      10.0 ↘  
 beste Teiler 17.4 (14.) 95.1 (15.) 168.6 (18.)  
 Trefferlage 0.48 mm links, 0.43 mm hoch  
 Streuwert 1.38, horizontal: 1.80, vertikal: 0.76

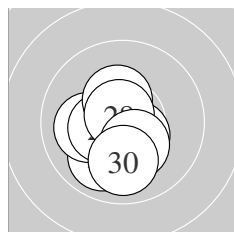

Serie 3:  
 10.4 \*                      10.3 \*                      9.9 ↙                      10.1 ←                      10.4 \*  
 10.4 \*                      10.5 \*                      10.7 \*                      10.3 \*                      10.0 ↓  
 beste Teiler 52.8 (28.) 116.0 (27.) 132.0 (25.)  
 Trefferlage 0.57 mm links, 0.77 mm tief  
 Streuwert 1.07, horizontal: 0.96, vertikal: 1.17

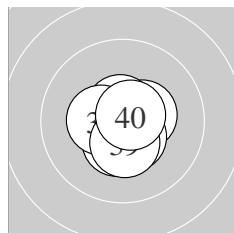

Serie 4:  
 10.7 \*                      10.7 \*                      10.7 \*                      10.4 \*                      10.4 \*  
 10.7 \*                      10.5 \*                      10.4 \*                      10.4 \*                      10.7 \*  
 beste Teiler 61.3 (33.) 62.6 (31.) 63.6 (40.)  
 Trefferlage 0.09 mm rechts, 0.38 mm tief  
 Streuwert 0.72, horizontal: 0.69, vertikal: 0.74

Unterschrift des Schützen

Meyton Elektronik

Ergebnis: **410.8** (392)  
 Serien: 103.6 102.7 102.8 101.7  
 Zähler: 32 8 0 0 0 0 0 0 0 0  
 Innenzehner: 27  
 weiteste: 369 (27), 343 (11), 332 (38)  
 beste Teiler 41.5 (8.) 58.4 (23.) 68.0 (18.)  
 Trefferlage 0.11 mm links, 0.24 mm hoch  
 Streuwert 1.34, horizontal: 1.55, vertikal: 1.09

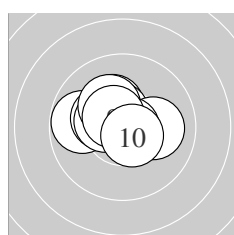
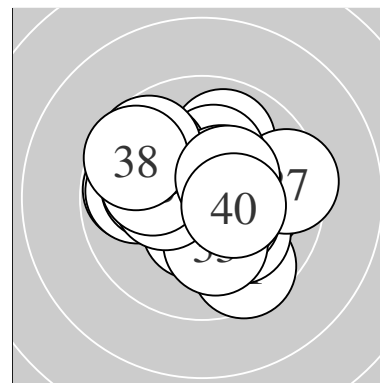

Serie 1:  
 10.3 \*                      9.8 ←                      10.5 \*                      10.3 \*                      10.4 \*  
 10.1 →                      10.2 \*                      10.8 \*                      10.6 \*                      10.6 \*  
 beste Teiler 41.5 (8.) 90.6 (10.) 98.4 (9.)  
 Trefferlage 0.49 mm links, 0.54 mm hoch  
 Streuwert 1.09, horizontal: 1.37, vertikal: 0.69

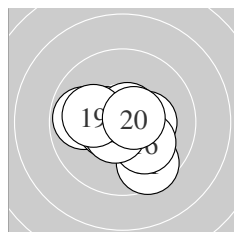

Serie 2:  
 9.6 ↘                      9.8 ←                      10.4 \*                      10.3 \*                      10.5 \*  
 10.1 ↘                      10.6 \*                      10.7 \*                      10.1 ←                      10.6 \*  
 beste Teiler 68.0 (18.) 85.4 (20.) 87.0 (17.)  
 Trefferlage 0.14 mm links, 0.35 mm tief  
 Streuwert 1.39, horizontal: 1.63, vertikal: 1.10

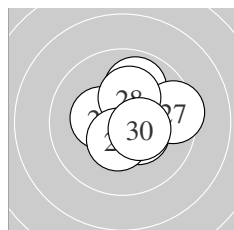

Serie 3:  
 10.6 \*                      10.4 \*                      10.7 \*                      10.3 \*                      10.4 \*  
 9.9 ↑                      9.5 →                      10.2 \*                      10.4 \*                      10.4 \*  
 beste Teiler 58.4 (23.) 87.0 (21.) 129.5 (29.)  
 Trefferlage 0.83 mm rechts, 0.27 mm hoch  
 Streuwert 1.22, horizontal: 1.31, vertikal: 1.12

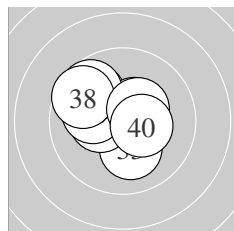

Serie 4:  
 10.7 \*                      9.9 ↖                      10.1 ↓                      10.3 \*                      10.5 \*  
 10.1 ←                      9.7 ↖                      9.6 ↖                      10.4 \*                      10.4 \*  
 beste Teiler 68.4 (31.) 120.9 (35.) 139.6 (39.)  
 Trefferlage 0.66 mm links, 0.52 mm hoch  
 Streuwert 1.46, horizontal: 1.63, vertikal: 1.27

Unterschrift des Schützen

Meyton Elektronik

Ergebnis: **406.8** (390)  
 Serien: 100.0 102.8 102.6 101.4  
 Zähler: 31 8 1 0 0 0 0 0 0  
 Innenzehner: 26  
 weiteste: 512 (6), 486 (40), 433 (30)  
 beste Teiler 14.7 (21.) 35.2 (37.) 47.8 (26.)  
 Trefferlage 0.27 mm rechts, 0.07 mm hoch  
 Streuwert 1.64, horizontal: 2.06, vertikal: 1.07

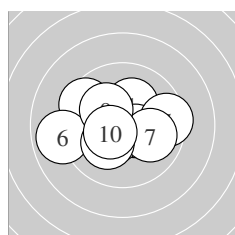
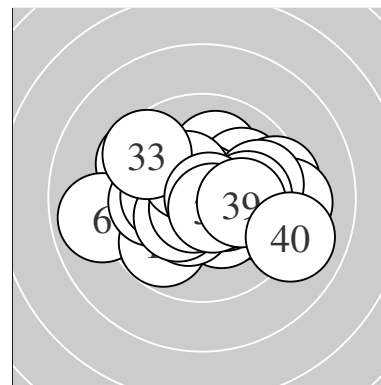

Serie 1:  
 10.2 \*                      10.5 \*                      9.5 ↘                      10.5 \*                      9.5 →  
 8.9 ←                      10.0 →                      10.2 \*                      10.2 \*                      10.5 \*  
 beste Teiler 110.1 (4.) 118.1 (2.) 119.5 (10.)  
 Trefferlage 0.46 mm links, 0.01 mm tief  
 Streuwert 1.99, horizontal: 2.55, vertikal: 1.20

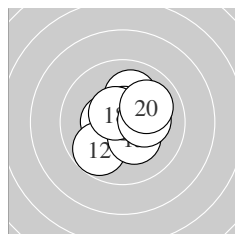

Serie 2:  
 10.4 \*                      9.8 ↙                      10.3 \*                      10.2 \*                      10.6 \*  
 10.1 ↑                      10.6 \*                      10.6 \*                      10.2 \*                      10.0 ↗  
 beste Teiler 77.1 (17.) 93.0 (15.) 96.5 (18.)  
 Trefferlage 0.28 mm rechts, 0.39 mm hoch  
 Streuwert 1.30, horizontal: 1.30, vertikal: 1.31

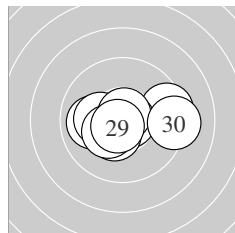

Serie 3:  
 10.9 \*                      10.0 ←                      9.4 →                      10.2 \*                      10.7 \*  
 10.8 \*                      10.4 \*                      10.3 \*                      10.7 \*                      9.2 →  
 beste Teiler 14.7 (21.) 47.8 (26.) 52.7 (25.)  
 Trefferlage 0.19 mm rechts, 0.16 mm tief  
 Streuwert 1.62, horizontal: 2.21, vertikal: 0.61

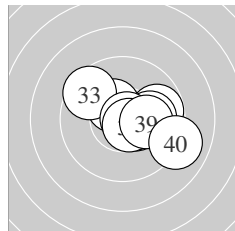

Serie 4:  
 10.4 \*                      9.8 →                      9.5 ↘                      10.0 →                      10.5 \*  
 10.5 \*                      10.8 \*                      10.7 \*                      10.2 \*                      9.0 ↘  
 beste Teiler 35.2 (37.) 74.2 (38.) 101.0 (36.)  
 Trefferlage 1.09 mm rechts, 0.06 mm hoch  
 Streuwert 1.62, horizontal: 2.00, vertikal: 1.11

Unterschrift des Schützen

Meyton Elektronik

Ergebnis: **404.1** (386)  
 Serien: 99.3 101.1 102.2 101.5  
 Zähler: 26 14 0 0 0 0 0 0 0 0  
 Innenzehner: 18  
 weiteste: 482 (7), 378 (17), 359 (18)  
 beste Teiler 26.6 (15.) 47.8 (23.) 50.1 (8.)  
 Trefferlage 0.33 mm links, 0.19 mm hoch  
 Streuwert 1.65, horizontal: 2.02, vertikal: 1.18

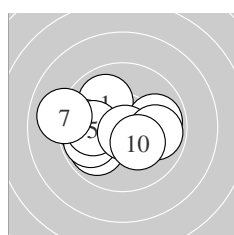
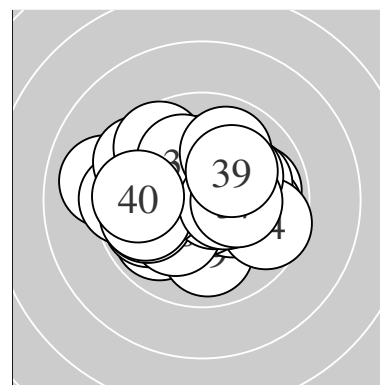

Serie 1:  
 10.0 ↖                      9.9 ↙                      9.7 ←                      9.8 ←                      10.0 ←  
    9.9 →                      9.0 ←                      10.8 \*                      9.9 →                      10.3 \*  
 beste Teiler 50.1 (8.) 173.9 (10.) 240.1 (5.)  
 Trefferlage 0.95 mm links, 0.15 mm tief  
 Streuwert 1.94, horizontal: 2.52, vertikal: 1.10

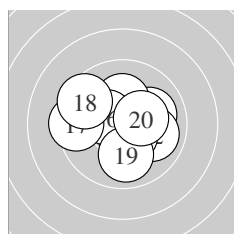

Serie 2:  
 10.0 →                      10.0 →                      10.5 \*                      10.2 \*                      10.8 \*  
    10.4 \*                      9.4 ←                      9.5 ↘                      10.0 ↓                      10.3 \*  
 beste Teiler 26.6 (15.) 110.1 (13.) 141.5 (16.)  
 Trefferlage 0.14 mm links, 0.12 mm hoch  
 Streuwert 1.73, horizontal: 2.06, vertikal: 1.31

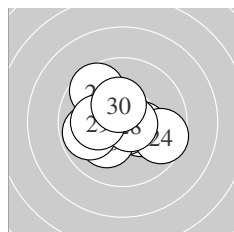

Serie 3:  
 10.6 \*                      10.3 \*                      10.8 \*                      9.6 →                      9.6 ↖  
    10.2 \*                      9.8 ←                      10.7 \*                      10.2 \*                      10.4 \*  
 beste Teiler 47.8 (23.) 63.0 (28.) 85.4 (21.)  
 Trefferlage 0.34 mm links, 0.00 mm  
 Streuwert 1.53, horizontal: 1.78, vertikal: 1.24

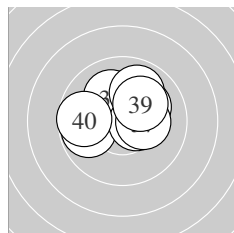

Serie 4:  
 10.6 \*                      10.4 \*                      10.1 ↗                      10.1 ↖                      9.8 ←  
    10.5 \*                      10.3 \*                      9.9 ↑                      10.1 ↗                      9.7 ←  
 beste Teiler 87.6 (31.) 111.3 (36.) 137.3 (32.)  
 Trefferlage 0.10 mm rechts, 0.81 mm hoch  
 Streuwert 1.45, horizontal: 1.80, vertikal: 0.98

Unterschrift des Schützen

Meyton Elektronik

Ergebnis: **407.2** (386)  
 Serien: 99.7 101.3 101.7 104.5  
 Zähler: 27 12 1 0 0 0 0 0 0 0  
 Innenzehner: 21  
 weiteste: 503 (2), 415 (21), 304 (3)  
 beste Teiler 15.6 (29.) 42.7 (5.) 59.6 (28.)  
 Trefferlage 0.49 mm links, 0.21 mm tief  
 Streuwert 1.53, horizontal: 1.89, vertikal: 1.05

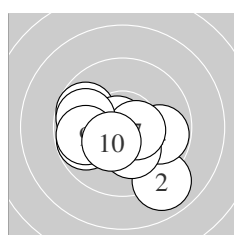
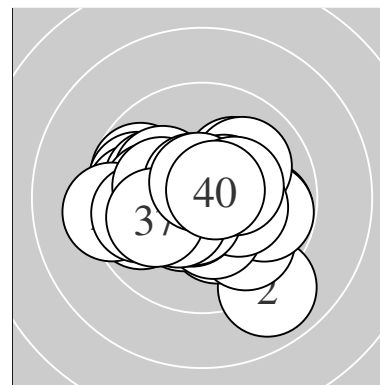

Serie 1:  
 9.8 ←                      8.9 ↘                      9.7 ↖                      9.8 →                      10.8 \*  
 10.2 \*                      10.5 \*                      9.8 ←                      9.8 ←                      10.4 \*  
 beste Teiler 42.7 (5.) 104.5 (7.) 138.2 (10.)  
 Trefferlage 0.49 mm links, 0.72 mm tief  
 Streuwert 1.93, horizontal: 2.31, vertikal: 1.45

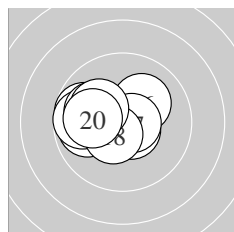

Serie 2:  
 10.6 \*                      9.7 ←                      9.9 ←                      9.7 ←                      10.0 ↖  
 10.1 ↗                      10.7 \*                      10.5 \*                      10.1 ↖                      10.0 ←  
 beste Teiler 68.3 (17.) 85.7 (11.) 116.2 (18.)  
 Trefferlage 1.28 mm links, 0.26 mm hoch  
 Streuwert 1.30, horizontal: 1.67, vertikal: 0.76

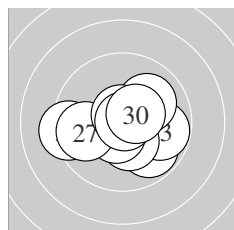

Serie 3:  
 9.3 ←                      9.8 ↘                      9.8 →                      10.3 \*                      10.0 ↗  
 10.6 \*                      9.8 ←                      10.7 \*                      10.9 \*                      10.5 \*  
 beste Teiler 15.6 (29.) 59.6 (28.) 99.7 (26.)  
 Trefferlage 0.08 mm rechts, 0.35 mm tief  
 Streuwert 1.69, horizontal: 2.15, vertikal: 1.03

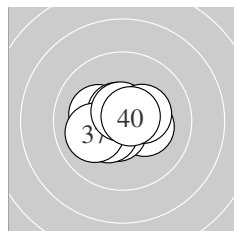

Serie 4:  
 10.3 \*                      10.2 \*                      10.7 \*                      10.6 \*                      10.6 \*  
 10.4 \*                      10.0 ←                      10.7 \*                      10.3 \*                      10.7 \*  
 beste Teiler 59.8 (33.) 70.8 (40.) 73.7 (38.)  
 Trefferlage 0.28 mm links, 0.03 mm tief  
 Streuwert 1.01, horizontal: 1.26, vertikal: 0.68

Unterschrift des Schützen

Meyton Elektronik

Ergebnis: **406.3** (390)  
 Serien: 100.0 99.2 103.3 103.8  
 Zähler: 31 8 1 0 0 0 0 0 0  
 Innenzehner: 25  
 weiteste: 575 (6), 469 (15), 449 (18)  
 beste Teiler 36.8 (27.) 50.2 (37.) 51.0 (39.)  
 Trefferlage 0.16 mm links, 0.24 mm tief  
 Streuwert 1.65, horizontal: 2.09, vertikal: 1.03

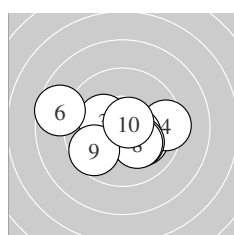
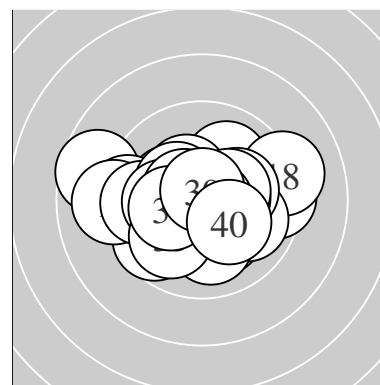

Serie 1:  
 10.4 \*                      10.1 ↘                      10.2 \*                      9.4 →                      10.4 \*  
 8.7 ←                      10.2 \*                      10.2 \*                      9.7 ↙                      10.7 \*  
 beste Teiler 66.2 (10.) 127.4 (5.) 130.0 (1.)  
 Trefferlage 0.07 mm links, 0.45 mm tief  
 Streuwert 2.05, horizontal: 2.68, vertikal: 1.10

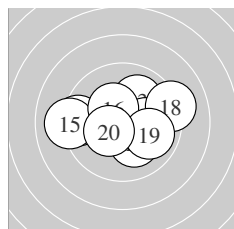

Serie 2:  
 10.6 \*                      9.4 ←                      10.0 ↗                      10.1 →                      9.1 ←  
 10.4 \*                      10.1 ↘                      9.2 →                      9.9 ↘                      10.4 \*  
 beste Teiler 100.7 (11.) 143.9 (20.) 148.3 (16.)  
 Trefferlage 0.01 mm rechts, 0.19 mm hoch  
 Streuwert 2.15, horizontal: 2.80, vertikal: 1.18

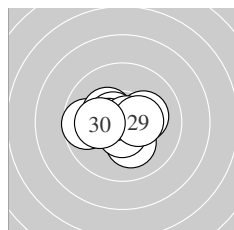

Serie 3:  
 9.7 ←                      10.3 \*                      10.6 \*                      10.4 \*                      10.2 \*  
 10.2 \*                      10.8 \*                      10.6 \*                      10.4 \*                      10.1 ←  
 beste Teiler 36.8 (27.) 90.0 (28.) 95.2 (23.)  
 Trefferlage 0.43 mm links, 0.11 mm tief  
 Streuwert 1.24, horizontal: 1.58, vertikal: 0.76

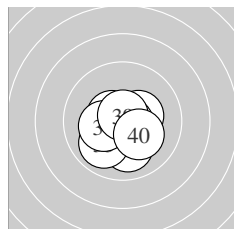

Serie 4:  
 10.6 \*                      10.5 \*                      10.4 \*                      10.0 ↓                      9.9 ↙  
 10.4 \*                      10.8 \*                      10.3 \*                      10.7 \*                      10.2 \*  
 beste Teiler 50.2 (37.) 51.0 (39.) 81.3 (31.)  
 Trefferlage 0.15 mm links, 0.63 mm tief  
 Streuwert 1.06, horizontal: 1.12, vertikal: 1.00

Unterschrift des Schützen

Meyton Elektronik



Ergebnis: **410.1** (391)  
 Serien: 100.5 102.9 102.5 104.2  
 Zähler: 31 9 0 0 0 0 0 0 0 0  
 Innenzehner: 25  
 weiteste: 381 (10), 347 (3), 323 (5)  
 beste Teiler 16.9 (37.) 18.9 (33.) 48.0 (1.)  
 Trefferlage 0.50 mm links, 0.21 mm hoch  
 Streuwert 1.36, horizontal: 1.39, vertikal: 1.32

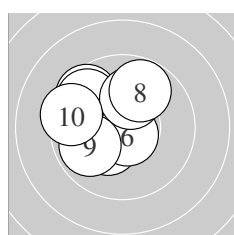
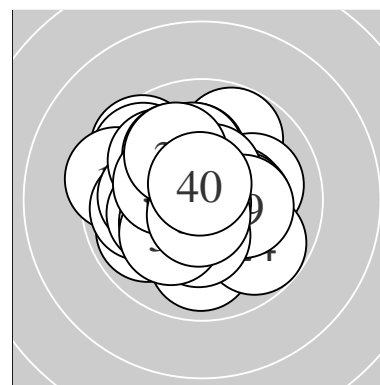

Serie 1:  
 10.8 \*                      10.2 \*                      9.6 ↘                      10.3 \*                      9.7 ↘  
 10.7 \*                      10.1 ↑                      9.8 ↑                      9.9 ↙                      9.4 ↙  
 beste Teiler 48.0 (1.) 65.5 (6.) 163.1 (4.)  
 Trefferlage 1.16 mm links, 0.79 mm hoch  
 Streuwert 1.57, horizontal: 1.62, vertikal: 1.51

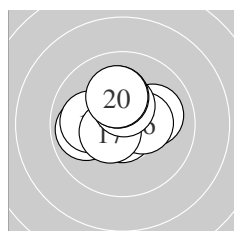

Serie 2:  
 10.7 \*                      9.9 ←                      10.0 →                      10.7 \*                      10.0 ←  
 10.4 \*                      10.5 \*                      10.4 \*                      10.2 \*                      10.1 ↑  
 beste Teiler 54.0 (11.) 73.5 (14.) 106.5 (17.)  
 Trefferlage 0.28 mm links, 0.54 mm hoch  
 Streuwert 1.24, horizontal: 1.46, vertikal: 0.96

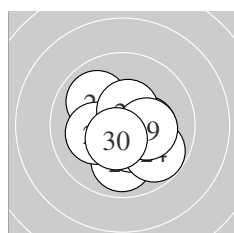

Serie 3:  
 9.9 ↓                      10.3 \*                      10.4 \*                      9.8 ↘                      10.7 \*  
 9.9 ↘                      10.2 \*                      10.5 \*                      10.3 \*                      10.5 \*  
 beste Teiler 71.4 (25.) 109.1 (30.) 112.2 (28.)  
 Trefferlage 0.18 mm rechts, 0.52 mm tief  
 Streuwert 1.35, horizontal: 1.44, vertikal: 1.26

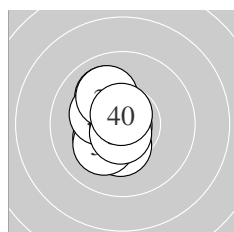

Serie 4:  
 10.3 \*                      10.3 \*                      10.9 \*                      10.2 \*                      10.0 ↘  
 10.2 \*                      10.9 \*                      10.7 \*                      10.0 ↘                      10.7 \*  
 beste Teiler 16.9 (37.) 18.9 (33.) 66.7 (38.)  
 Trefferlage 0.73 mm links, 0.05 mm hoch  
 Streuwert 1.01, horizontal: 0.64, vertikal: 1.27

Unterschrift des Schützen

Meyton Elektronik

Ergebnis: **416.5** (397)  
 Serien: 104.0 105.0 104.0 103.5  
 Zähler: 37 3 0 0 0 0 0 0 0 0  
 Innenzehner: 37  
 weiteste: 352 (30), 293 (33), 254 (31)  
 beste Teiler 13.4 (26.) 61.1 (5.) 70.1 (3.)  
 Trefferlage 0.06 mm rechts, 0.28 mm hoch  
 Streuwert 1.06, horizontal: 1.15, vertikal: 0.96

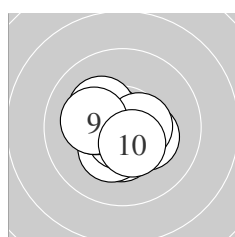
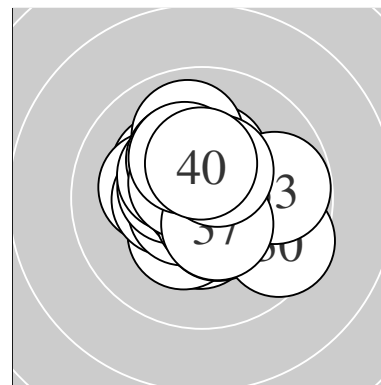

Serie 1:  
 10.4 \* 10.3 \* 10.7 \* 10.3 \* 10.7 \*  
 10.2 \* 10.2 \* 10.5 \* 10.2 \* 10.5 \*  
 beste Teiler 61.1 (5.) 70.1 (3.) 109.1 (8.)  
 Trefferlage 0.34 mm links, 0.27 mm tief  
 Streuwert 1.04, horizontal: 1.18, vertikal: 0.88

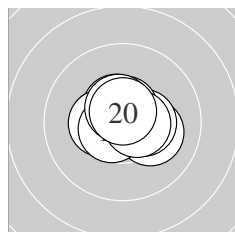

Serie 2:  
 10.4 \* 10.2 \* 10.4 \* 10.5 \* 10.4 \*  
 10.6 \* 10.6 \* 10.6 \* 10.6 \* 10.7 \*  
 beste Teiler 72.0 (20.) 85.0 (17.) 85.4 (16.)  
 Trefferlage 0.02 mm rechts, 0.21 mm hoch  
 Streuwert 0.88, horizontal: 1.08, vertikal: 0.60

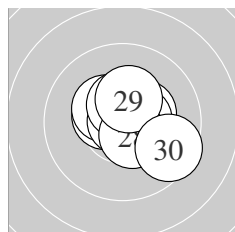

Serie 3:  
 10.4 \* 10.5 \* 10.5 \* 10.5 \* 10.4 \*  
 10.9 \* 10.5 \* 10.5 \* 10.3 \* 9.5 ↘  
 beste Teiler 13.4 (26.) 107.0 (22.) 107.6 (28.)  
 Trefferlage 0.41 mm rechts, 0.33 mm hoch  
 Streuwert 1.13, horizontal: 1.25, vertikal: 0.99

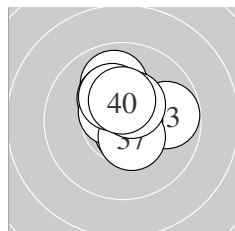

Serie 4:  
 9.9 ↑ 10.3 \* 9.8 → 10.7 \* 10.5 \*  
 10.6 \* 10.5 \* 10.3 \* 10.5 \* 10.4 \*  
 beste Teiler 72.9 (34.) 93.6 (36.) 120.2 (35.)  
 Trefferlage 0.15 mm rechts, 0.85 mm hoch  
 Streuwert 1.09, horizontal: 1.11, vertikal: 1.07

Unterschrift des Schützen

Meyton Elektronik

Ergebnis:	<b>398.3</b>	(380)
Serien:	97.9	99.9 99.6 100.9
Zähler:	23	14 3 0 0 0 0 0 0 0
Innenzehner:	20	
weiteste:	694	(22), 611 (13), 559 (8)
beste Teiler	44.4	(21.) 49.9 (28.) 77.1 (24.)
Trefferlage	0.15 mm	rechts, 0.19 mm hoch
Streuwert	2.10,	horizontal: 2.65, vertikal: 1.33

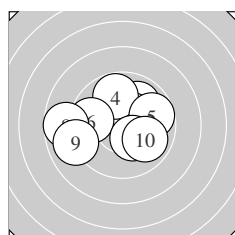
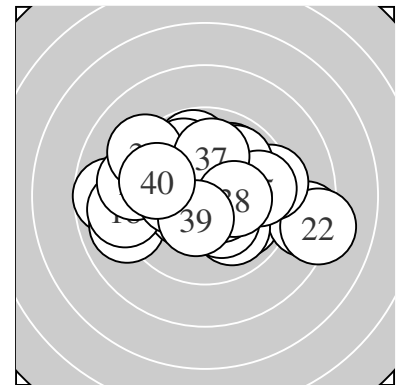

Serie 1:					
	9.9 ↗	10.5 *	10.4 *	9.8 ↑	9.7 →
	9.7 ←	10.3 *	8.7 ←	9.0 ←	9.9 ↘
beste Teiler	105.0 (2.) 129.4 (3.) 161.8 (7.)				
Trefferlage	0.46 mm links, 0.29 mm hoch				
Streuwert	2.34, horizontal: 2.96, vertikal: 1.49				

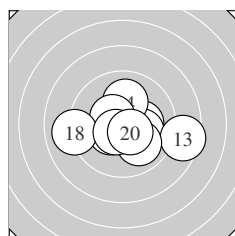

Serie 2:					
	10.2 *	10.2 *	8.5 →	10.1 ↑	10.4 *
	10.5 *	10.0 ↘	9.0 ←	10.5 *	10.5 *
beste Teiler	103.5 (19.) 108.2 (20.) 120.3 (16.)				
Trefferlage	0.46 mm rechts, 0.41 mm tief				
Streuwert	2.11, horizontal: 2.76, vertikal: 1.15				

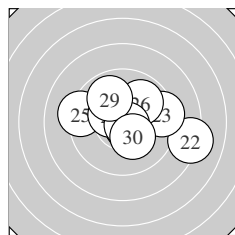

Serie 3:					
	10.8 *	8.2 →	9.4 →	10.6 *	9.3 ←
	9.9 ↗	10.4 *	10.8 *	9.9 ↘	10.3 *
beste Teiler	44.4 (21.) 49.9 (28.) 77.1 (24.)				
Trefferlage	0.80 mm rechts, 0.23 mm hoch				
Streuwert	2.29, horizontal: 2.95, vertikal: 1.35				

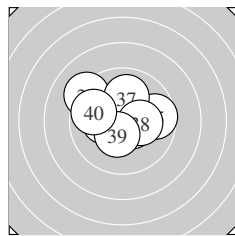

Serie 4:					
	10.2 *	9.2 ↘	10.5 *	10.3 *	9.7 →
	10.5 *	10.0 ↑	10.3 *	10.4 *	9.8 ←
beste Teiler	101.7 (33.) 107.3 (36.) 142.6 (39.)				
Trefferlage	0.19 mm links, 0.68 mm hoch				
Streuwert	1.70, horizontal: 2.06, vertikal: 1.26				

Unterschrift des Schützen

Ergebnis: **407.1** (391)  
 Serien: 98.7 102.9 102.7 102.8  
 Zähler: 32 7 1 0 0 0 0 0 0 0  
 Innenzehner: 22  
 weiteste: 657 (2), 349 (21), 330 (3)  
 beste Teiler 18.3 (32.) 32.3 (27.) 65.0 (18.)  
 Trefferlage 0.04 mm links, 0.27 mm tief  
 Streuwert 1.57, horizontal: 1.87, vertikal: 1.21

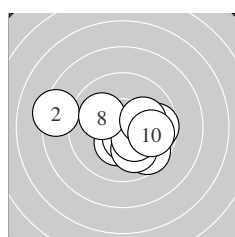
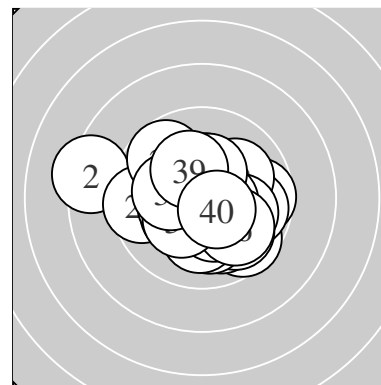

Serie 1:  
 9.7 →                      8.3 ←                      9.6 ↘                      10.3 \*                      10.5 \*  
 10.0 ↘                      10.3 \*                      10.1 ↖                      10.1 →                      9.8 →  
 beste Teiler 107.0 (5.) 154.9 (7.) 155.2 (4.)  
 Trefferlage 0.38 mm rechts, 0.54 mm tief  
 Streuwert 2.22, horizontal: 2.86, vertikal: 1.29

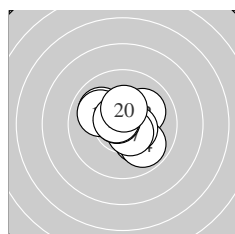

Serie 2:  
 10.0 ↖                      10.1 ↗                      10.1 ↘                      9.9 ↘                      10.5 \*  
 10.0 ↖                      10.5 \*                      10.7 \*                      10.7 \*                      10.4 \*  
 beste Teiler 65.0 (18.) 75.0 (19.) 108.9 (17.)  
 Trefferlage 0.19 mm rechts, 0.12 mm hoch  
 Streuwert 1.36, horizontal: 1.49, vertikal: 1.22

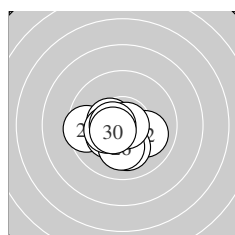

Serie 3:  
 9.6 ←                      10.0 →                      10.3 \*                      10.1 ↓                      10.4 \*  
 10.1 ↓                      10.8 \*                      10.3 \*                      10.6 \*                      10.5 \*  
 beste Teiler 32.3 (27.) 97.0 (29.) 106.9 (30.)  
 Trefferlage 0.66 mm links, 0.70 mm tief  
 Streuwert 1.21, horizontal: 1.49, vertikal: 0.84

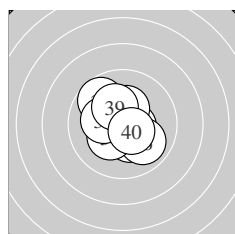

Serie 4:  
 10.5 \*                      10.9 \*                      9.7 ↖                      10.3 \*                      10.3 \*  
 9.9 ↘                      10.3 \*                      10.2 \*                      10.2 \*                      10.5 \*  
 beste Teiler 18.3 (32.) 103.1 (31.) 108.2 (40.)  
 Trefferlage 0.09 mm links, 0.03 mm hoch  
 Streuwert 1.34, horizontal: 1.32, vertikal: 1.37

Unterschrift des Schützen

Meyton Elektronik

Ergebnis: **413.5** (394)  
 Serien: 102.8 102.4 104.7 103.6  
 Zähler: 34 6 0 0 0 0 0 0 0 0  
 Innenzehner: 29  
 weiteste: 410 (4), 339 (40), 276 (18)  
 beste Teiler 21.0 (29.) 39.2 (37.) 44.5 (21.)  
 Trefferlage 0.33 mm rechts, 0.21 mm hoch  
 Streuwert 1.23, horizontal: 1.34, vertikal: 1.10

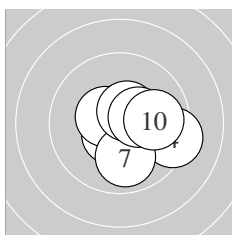
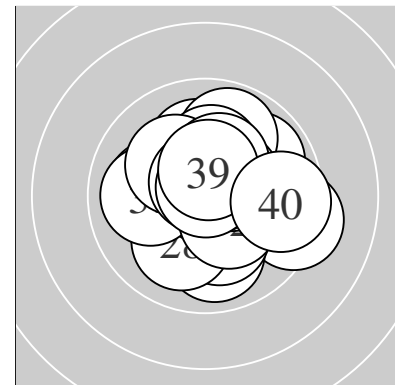

Serie 1:  
 10.6 \*                      10.7 \*                      10.5 \*                      9.3 →                      10.5 \*  
 10.5 \*                      9.9 ↓                      10.5 \*                      10.4 \*                      9.9 →  
 beste Teiler 67.8 (2.) 81.7 (1.) 101.8 (5.)  
 Trefferlage 0.86 mm rechts, 0.27 mm tief  
 Streuwert 1.28, horizontal: 1.48, vertikal: 1.05

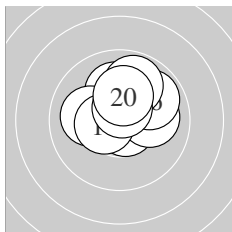

Serie 2:  
 10.4 \*                      10.7 \*                      10.1 ↑                      10.1 →                      10.1 ←  
 9.9 ↗                      10.5 \*                      9.8 ↑                      10.6 \*                      10.2 \*  
 beste Teiler 63.6 (12.) 93.9 (19.) 116.4 (17.)  
 Trefferlage 0.20 mm rechts, 1.00 mm hoch  
 Streuwert 1.23, horizontal: 1.39, vertikal: 1.03

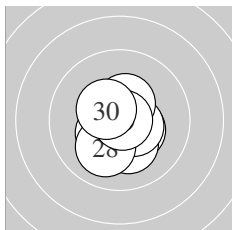

Serie 3:  
 10.8 \*                      10.4 \*                      10.2 \*                      10.5 \*                      10.4 \*  
 10.6 \*                      10.4 \*                      10.1 ↙                      10.9 \*                      10.4 \*  
 beste Teiler 21.0 (29.) 44.5 (21.) 85.9 (26.)  
 Trefferlage 0.00 mm , 0.37 mm tief  
 Streuwert 0.96, horizontal: 0.88, vertikal: 1.04

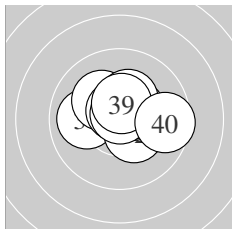

Serie 4:  
 10.0 ←                      10.4 \*                      10.2 \*                      10.4 \*                      10.7 \*  
 10.7 \*                      10.8 \*                      10.3 \*                      10.5 \*                      9.6 →  
 beste Teiler 39.2 (37.) 66.5 (35.) 67.6 (36.)  
 Trefferlage 0.27 mm rechts, 0.50 mm hoch  
 Streuwert 1.22, horizontal: 1.55, vertikal: 0.77

Unterschrift des Schützen

Meyton Elektronik

Ergebnis: **414.5** (396)  
 Serien: 104.3 102.0 104.4 103.8  
 Zähler: 36 4 0 0 0 0 0 0 0 0  
 Innenzehner: 32  
 weiteste: 343 (13), 297 (5), 291 (2)  
 beste Teiler 30.5 (4.) 72.8 (7.) 81.6 (10.)  
 Trefferlage 0.31 mm links, 0.17 mm hoch  
 Streuwert 1.15, horizontal: 1.18, vertikal: 1.11

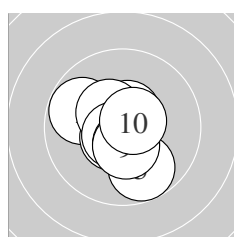
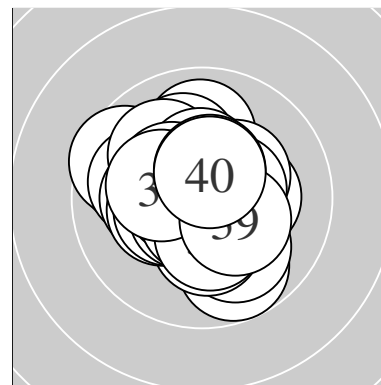

Serie 1:  
 10.6 \* 9.8 ↖ 10.6 \* 10.8 \* 9.8 ↘  
 10.4 \* 10.7 \* 10.5 \* 10.5 \* 10.6 \*  
 beste Teiler 30.5 (4.) 72.8 (7.) 81.6 (10.)  
 Trefferlage 0.16 mm links, 0.28 mm tief  
 Streuwert 1.15, horizontal: 1.10, vertikal: 1.21

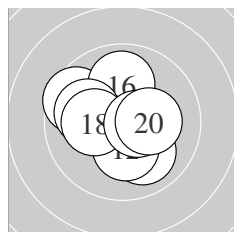

Serie 2:  
 10.0 ↘ 10.3 \* 9.6 ↖ 10.6 \* 10.5 \*  
 9.9 ↑ 10.0 ↖ 10.2 \* 10.6 \* 10.3 \*  
 beste Teiler 97.0 (14.) 99.6 (19.) 123.1 (15.)  
 Trefferlage 0.33 mm links, 0.20 mm hoch  
 Streuwert 1.51, horizontal: 1.68, vertikal: 1.33

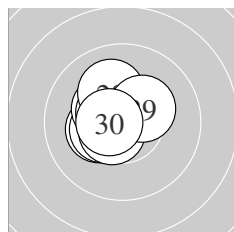

Serie 3:  
 10.3 \* 10.4 \* 10.6 \* 10.6 \* 10.4 \*  
 10.6 \* 10.5 \* 10.1 ↖ 10.3 \* 10.6 \*  
 beste Teiler 89.0 (30.) 90.3 (24.) 93.6 (26.)  
 Trefferlage 0.64 mm links, 0.41 mm hoch  
 Streuwert 0.84, horizontal: 0.87, vertikal: 0.81

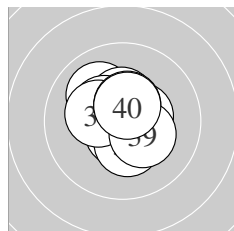

Serie 4:  
 10.0 ↘ 10.4 \* 10.6 \* 10.4 \* 10.3 \*  
 10.5 \* 10.3 \* 10.5 \* 10.3 \* 10.5 \*  
 beste Teiler 81.9 (33.) 107.5 (40.) 114.2 (38.)  
 Trefferlage 0.13 mm links, 0.37 mm hoch  
 Streuwert 1.06, horizontal: 1.05, vertikal: 1.07

Unterschrift des Schützen

Meyton Elektronik

Ergebnis: **411.6** (394)  
 Serien: 102.0 104.6 104.3 100.7  
 Zähler: 34 6 0 0 0 0 0 0 0 0  
 Innenzehner: 26  
 weiteste: 391 (38), 381 (31), 282 (3)  
 beste Teiler 15.5 (24.) 49.9 (18.) 52.0 (2.)  
 Trefferlage 0.34 mm links, 0.20 mm tief  
 Streuwert 1.31, horizontal: 1.46, vertikal: 1.14

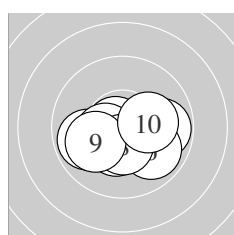
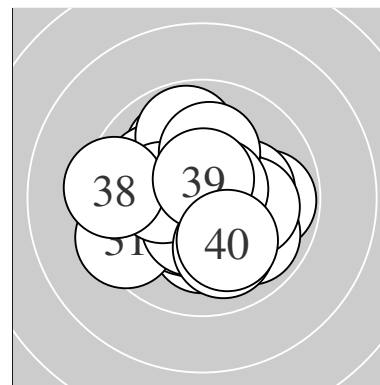

Serie 1:  
 10.4 \*                      10.7 \*                      9.8 →                      10.3 \*                      9.9 ←  
 9.9 ↘                      10.4 \*                      10.4 \*                      10.0 ←                      10.2 \*  
 beste Teiler 52.0 (2.) 128.0 (8.) 135.4 (7.)  
 Trefferlage 0.15 mm rechts, 0.72 mm tief  
 Streuwert 1.39, horizontal: 1.85, vertikal: 0.65

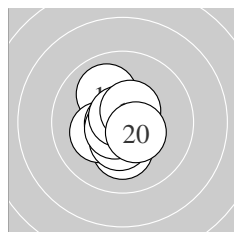

Serie 2:  
 10.0 ↖                      10.2 \*                      10.6 \*                      10.2 \*                      10.7 \*  
 10.4 \*                      10.7 \*                      10.8 \*                      10.5 \*                      10.5 \*  
 beste Teiler 49.9 (18.) 59.2 (15.) 74.5 (17.)  
 Trefferlage 0.37 mm links, 0.26 mm tief  
 Streuwert 0.98, horizontal: 0.78, vertikal: 1.15

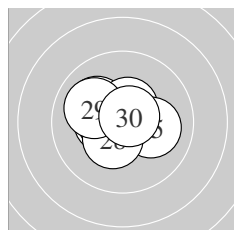

Serie 3:  
 10.7 \*                      10.1 ↖                      10.5 \*                      10.9 \*                      10.1 →  
 10.4 \*                      10.5 \*                      10.4 \*                      10.0 ↖                      10.7 \*  
 beste Teiler 15.5 (24.) 59.5 (21.) 65.1 (30.)  
 Trefferlage 0.47 mm links, 0.21 mm hoch  
 Streuwert 1.03, horizontal: 1.26, vertikal: 0.74

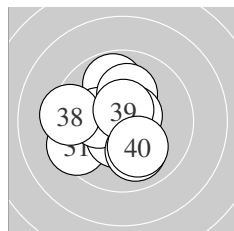

Serie 4:  
 9.4 ←                      10.4 \*                      9.8 ↑                      10.3 \*                      10.0 ↓  
 10.1 ↑                      10.6 \*                      9.4 ←                      10.6 \*                      10.1 ↓  
 beste Teiler 79.7 (37.) 84.2 (39.) 129.0 (32.)  
 Trefferlage 0.70 mm links, 0.03 mm tief  
 Streuwert 1.73, horizontal: 1.77, vertikal: 1.69

Unterschrift des Schützen

Meyton Elektronik

Ergebnis: **392.8** (372)  
 Serien: 94.1 99.8 98.5 100.4  
 Zähler: 18 17 4 1 0 0 0 0 0 0  
 Innenzehner: 15  
 weiteste: 804 (6), 571 (3), 554 (17)  
 beste Teiler 32.0 (11.) 41.8 (32.) 61.4 (38.)  
 Trefferlage 0.89 mm rechts, 0.21 mm hoch  
 Streuwert 2.27, horizontal: 2.67, vertikal: 1.79

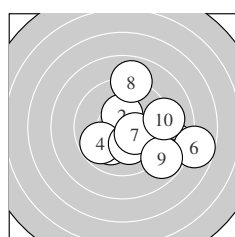
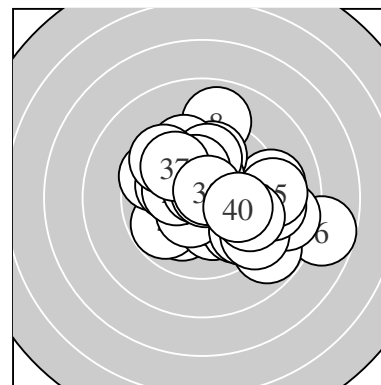

Serie 1:  
 10.1 ↙ 10.4 \* 8.7 → 9.8 ↙ 10.2 \*  
 7.7 → 10.4 \* 8.9 ↑ 8.8 ↘ 9.1 →  
 beste Teiler 133.1 (2.) 150.7 (7.) 191.6 (5.)  
 Trefferlage 2.11 mm rechts, 0.60 mm tief  
 Streuwert 2.84, horizontal: 3.22, vertikal: 2.40

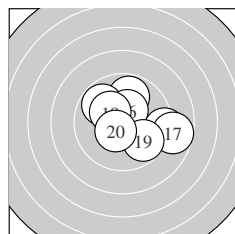

Serie 2:  
 10.8 \* 10.6 \* 9.8 ↑ 9.1 → 9.8 ↖  
 10.4 \* 8.7 → 10.3 \* 9.8 ↘ 10.5 \*  
 beste Teiler 32.0 (11.) 89.4 (12.) 121.8 (20.)  
 Trefferlage 0.96 mm rechts, 0.15 mm hoch  
 Streuwert 2.03, horizontal: 2.44, vertikal: 1.52

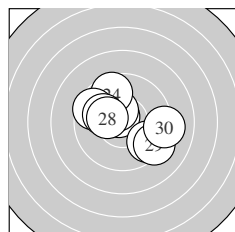

Serie 3:  
 10.7 \* 9.8 ↖ 10.4 \* 9.6 ↑ 9.6 ↖  
 9.6 ↘ 10.1 ↖ 10.3 \* 9.3 ↘ 9.1 →  
 beste Teiler 69.8 (21.) 138.0 (23.) 171.5 (28.)  
 Trefferlage 0.08 mm links, 0.39 mm hoch  
 Streuwert 2.23, horizontal: 2.67, vertikal: 1.68

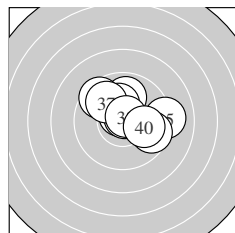

Serie 4:  
 10.7 \* 10.8 \* 9.9 ↑ 9.5 ↖ 9.1 →  
 10.2 \* 9.9 ↖ 10.7 \* 9.6 → 10.0 →  
 beste Teiler 41.8 (32.) 61.4 (38.) 68.4 (31.)  
 Trefferlage 0.60 mm rechts, 0.89 mm hoch  
 Streuwert 1.79, horizontal: 2.17, vertikal: 1.30

Unterschrift des Schützen

Meyton Elektronik



Ergebnis: **397.9** (379)  
 Serien: 99.0 100.7 99.7 98.5  
 Zähler: 21 17 2 0 0 0 0 0 0 0  
 Innenzehner: 16  
 weiteste: 525 (21), 519 (3), 484 (35)  
 beste Teiler 33.2 (8.) 49.0 (31.) 86.3 (10.)  
 Trefferlage 0.58 mm rechts, 0.94 mm hoch  
 Streuwert 1.88, horizontal: 2.28, vertikal: 1.37

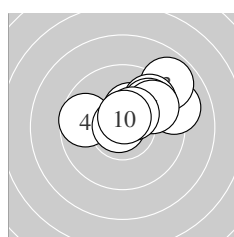
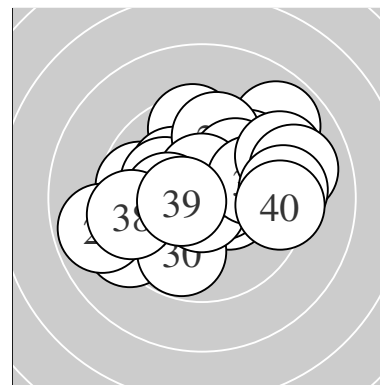

Serie 1:  
 9.1 → 10.3 \* 8.9 ↗ 9.7 ← 9.7 ↗  
 9.8 ↗ 9.7 ↗ 10.8 \* 10.4 \* 10.6 \*  
 beste Teiler 33.2 (8.) 86.3 (10.) 140.2 (9.)  
 Trefferlage 1.31 mm rechts, 1.52 mm hoch  
 Streuwert 1.68, horizontal: 2.17, vertikal: 0.97

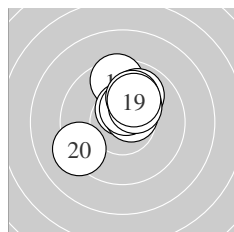

Serie 2:  
 10.0 ↑ 9.5 ↑ 10.5 \* 10.6 \* 9.9 ↗  
 10.5 \* 10.1 ↑ 10.3 \* 10.1 ↑ 9.2 ↖  
 beste Teiler 93.2 (14.) 109.1 (13.) 116.9 (16.)  
 Trefferlage 0.09 mm rechts, 1.40 mm hoch  
 Streuwert 1.48, horizontal: 1.42, vertikal: 1.53

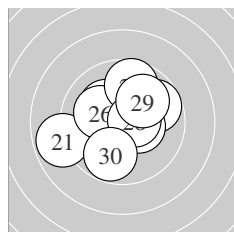

Serie 3:  
 8.9 ← 10.2 \* 9.7 ↗ 10.4 \* 10.3 \*  
 10.1 ↖ 9.7 ↑ 10.6 \* 10.0 ↗ 9.8 ↓  
 beste Teiler 98.9 (28.) 139.7 (24.) 157.1 (25.)  
 Trefferlage 0.33 mm links, 0.45 mm hoch  
 Streuwert 1.99, horizontal: 2.27, vertikal: 1.67

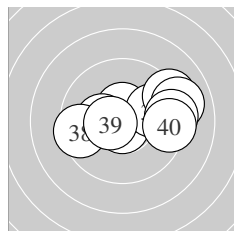

Serie 4:  
 10.8 \* 10.6 \* 9.9 → 9.2 → 9.0 →  
 10.3 \* 9.3 → 9.5 ← 10.5 \* 9.4 →  
 beste Teiler 49.0 (31.) 100.0 (32.) 104.3 (39.)  
 Trefferlage 1.26 mm rechts, 0.40 mm hoch  
 Streuwert 2.16, horizontal: 2.90, vertikal: 0.94

Unterschrift des Schützen

Meyton Elektronik

Ergebnis: **401.0** (382)  
 Serien: 100.0 101.7 101.1 98.2  
 Zähler: 23 16 1 0 0 0 0 0 0 0  
 Innenzehner: 20  
 weiteste: 631 (40), 446 (15), 425 (16)  
 beste Teiler 29.4 (18.) 60.4 (3.) 72.5 (34.)  
 Trefferlage 0.40 mm links, 0.48 mm tief  
 Streuwert 1.84, horizontal: 2.18, vertikal: 1.42

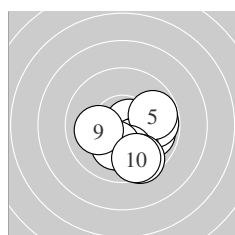
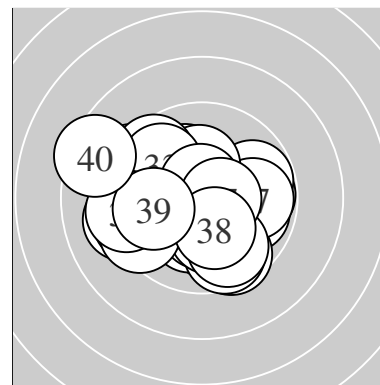

Serie 1:  
 9.9 → 9.8 → 10.7 \* 10.2 \* 9.8 →  
 10.0 ↓ 10.2 \* 9.6 ↘ 10.1 ← 9.7 ↓  
 beste Teiler 60.4 (3.) 191.9 (4.) 195.7 (7.)  
 Trefferlage 1.02 mm rechts, 1.18 mm tief  
 Streuwert 1.49, horizontal: 1.59, vertikal: 1.39

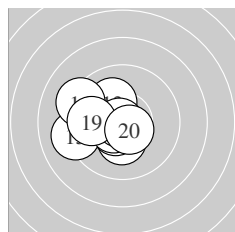

Serie 2:  
 10.5 \* 10.3 \* 10.1 ↗ 10.5 \* 9.2 ←  
 9.3 ↖ 10.6 \* 10.8 \* 9.8 ← 10.6 \*  
 beste Teiler 29.4 (18.) 92.0 (20.) 99.0 (17.)  
 Trefferlage 1.31 mm links, 0.23 mm tief  
 Streuwert 1.47, horizontal: 1.71, vertikal: 1.19

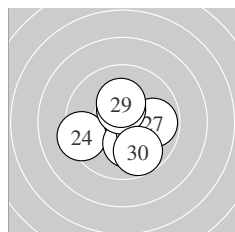

Serie 3:  
 10.4 \* 10.2 \* 10.4 \* 9.4 ← 10.2 \*  
 10.2 \* 9.8 → 10.5 \* 10.2 \* 9.8 ↓  
 beste Teiler 116.8 (28.) 129.2 (23.) 149.9 (21.)  
 Trefferlage 0.57 mm rechts, 0.66 mm tief  
 Streuwert 1.56, horizontal: 1.75, vertikal: 1.34

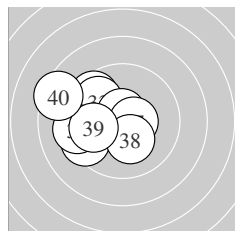

Serie 4:  
 9.5 ↖ 10.5 \* 9.8 ↖ 10.7 \* 9.4 ←  
 9.3 ← 10.5 \* 10.2 \* 9.9 ← 8.4 ↖  
 beste Teiler 72.5 (34.) 101.1 (37.) 106.3 (32.)  
 Trefferlage 1.91 mm links, 0.12 mm hoch  
 Streuwert 1.97, horizontal: 2.29, vertikal: 1.59

Unterschrift des Schützen

Meyton Elektronik

Ergebnis: **399.8** (381)  
 Serien: 98.8 100.4 100.6 100.0  
 Zähler: 26 9 5 0 0 0 0 0 0 0  
 Innenzehner: 22  
 weiteste: 690 (3), 568 (17), 556 (5)  
 beste Teiler 42.0 (26.) 53.7 (7.) 69.5 (9.)  
 Trefferlage 0.22 mm rechts, 0.47 mm hoch  
 Streuwert 2.01, horizontal: 2.51, vertikal: 1.34

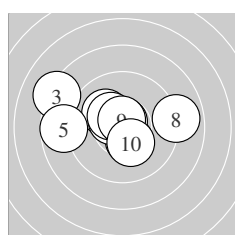
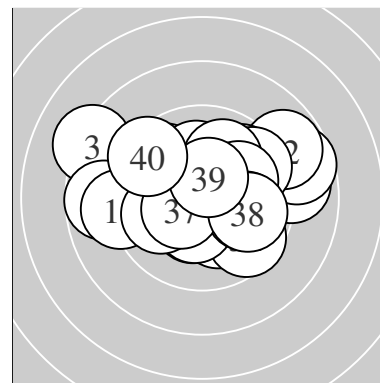

Serie 1:  
 10.4 \* 10.1 ↘ 8.2 ↘ 10.5 \* 8.7 ←  
 10.3 \* 10.7 \* 8.9 → 10.7 \* 10.3 \*  
 beste Teiler 53.7 (7.) 69.5 (9.) 116.1 (4.)  
 Trefferlage 0.90 mm links, 0.52 mm hoch  
 Streuwert 2.44, horizontal: 3.21, vertikal: 1.28

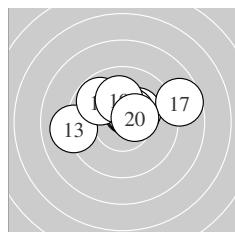

Serie 2:  
 10.5 \* 10.4 \* 9.1 ← 10.5 \* 10.3 \*  
 10.5 \* 8.7 → 9.8 ↘ 10.1 ↑ 10.5 \*  
 beste Teiler 113.3 (11.) 119.4 (14.) 121.2 (16.)  
 Trefferlage 0.33 mm rechts, 1.09 mm hoch  
 Streuwert 1.89, horizontal: 2.55, vertikal: 0.81

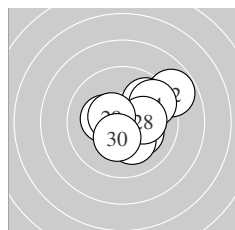

Serie 3:  
 10.2 \* 8.8 ↗ 9.8 ↗ 9.6 ↗ 10.2 \*  
 10.8 \* 10.2 \* 10.2 \* 10.5 \* 10.3 \*  
 beste Teiler 42.0 (26.) 116.2 (29.) 154.0 (30.)  
 Trefferlage 1.06 mm rechts, 0.29 mm hoch  
 Streuwert 1.74, horizontal: 1.95, vertikal: 1.50

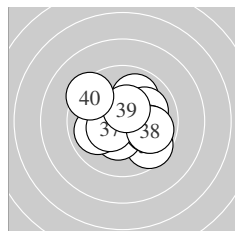

Serie 4:  
 10.0 ↗ 9.6 ↘ 10.0 ↗ 10.4 \* 9.9 →  
 9.9 ← 10.4 \* 9.9 → 10.5 \* 9.4 ↘  
 beste Teiler 121.4 (39.) 135.5 (37.) 150.0 (34.)  
 Trefferlage 0.40 mm rechts, 0.00 mm  
 Streuwert 1.85, horizontal: 2.10, vertikal: 1.57

Unterschrift des Schützen

Meyton Elektronik

Ergebnis: **398.1** (383)  
 Serien: 99.6 98.9 98.8 100.8  
 Zähler: 25 14 0 1 0 0 0 0 0 0  
 Innenzehner: 14  
 weiteste: 910 (26), 485 (15), 438 (16)  
 beste Teiler 40.4 (34.) 71.8 (33.) 84.4 (40.)  
 Trefferlage 0.27 mm rechts, 0.00 mm  
 Streuwert 2.07, horizontal: 2.57, vertikal: 1.40

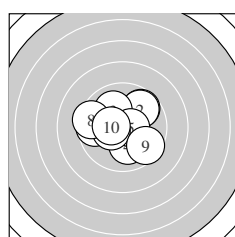
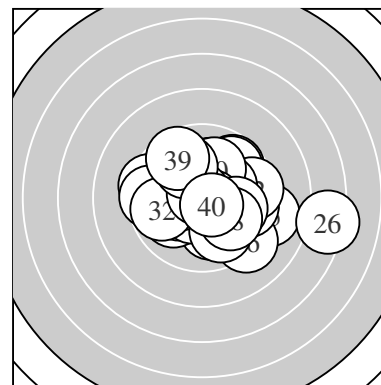

Serie 1:  
 9.7 ↗ 9.8 ↗ 10.0 ↘ 10.1 ↓ 10.6 \*  
 9.6 ← 10.4 \* 9.4 ← 9.6 ↘ 10.4 \*  
 beste Teiler 96.1 (5.) 135.8 (10.) 142.3 (7.)  
 Trefferlage 0.22 mm links, 0.26 mm hoch  
 Streuwert 1.97, horizontal: 2.27, vertikal: 1.61

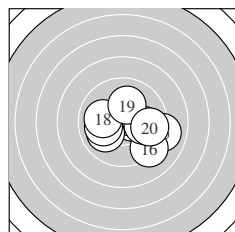

Serie 2:  
 10.5 \* 10.5 \* 10.0 ↙ 10.0 ← 9.0 →  
 9.2 ↘ 10.0 → 10.0 ← 10.1 ↑ 9.6 →  
 beste Teiler 103.8 (12.) 115.0 (11.) 208.5 (19.)  
 Trefferlage 0.93 mm rechts, 0.39 mm tief  
 Streuwert 2.01, horizontal: 2.50, vertikal: 1.35

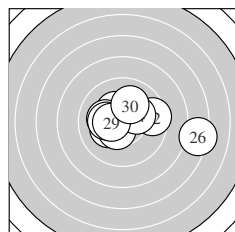

Serie 3:  
 10.2 \* 9.5 → 10.5 \* 10.2 \* 10.3 \*  
 7.3 → 10.1 ← 10.2 \* 10.4 \* 10.1 ↑  
 beste Teiler 120.3 (23.) 132.0 (29.) 164.2 (25.)  
 Trefferlage 0.65 mm rechts, 0.19 mm hoch  
 Streuwert 2.55, horizontal: 3.42, vertikal: 1.14

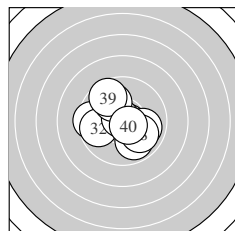

Serie 4:  
 9.5 ← 9.8 ← 10.7 \* 10.8 \* 9.9 →  
 10.0 ↘ 9.9 ↘ 10.0 ↘ 9.6 ↘ 10.6 \*  
 beste Teiler 40.4 (34.) 71.8 (33.) 84.4 (40.)  
 Trefferlage 0.25 mm links, 0.07 mm tief  
 Streuwert 1.82, horizontal: 2.05, vertikal: 1.56

Unterschrift des Schützen

Meyton Elektronik

Ergebnis: **414.3** (397)  
 Serien: 103.9 103.7 102.8 103.9  
 Zähler: 37 3 0 0 0 0 0 0 0 0  
 Innenzehner: 31  
 weiteste: 407 (12), 275 (5), 269 (24)  
 beste Teiler 46.0 (40.) 50.9 (10.) 69.1 (27.)  
 Trefferlage 0.29 mm rechts, 0.09 mm tief  
 Streuwert 1.18, horizontal: 1.38, vertikal: 0.95

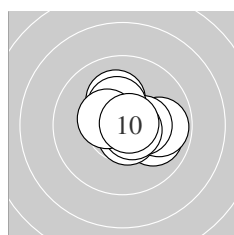
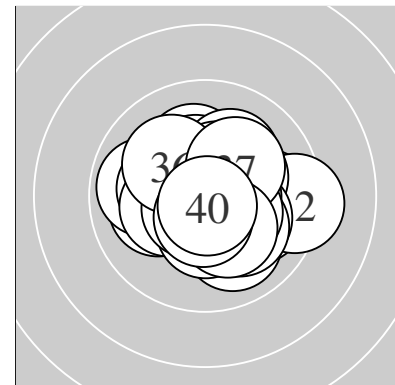

Serie 1:  
 10.6 \*                      10.2 \*                      10.0 →                      10.6 \*                      9.9 →  
 10.4 \*                      10.4 \*                      10.6 \*                      10.4 \*                      10.8 \*  
 beste Teiler 50.9 (10.) 81.3 (8.) 84.5 (4.)  
 Trefferlage 0.68 mm rechts, 0.19 mm hoch  
 Streuwert 1.08, horizontal: 1.24, vertikal: 0.88

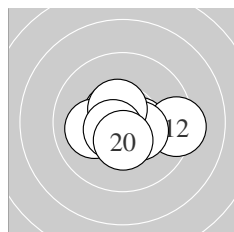

Serie 2:  
 10.5 \*                      9.3 →                      10.4 \*                      10.6 \*                      10.7 \*  
 10.6 \*                      10.1 ←                      10.5 \*                      10.6 \*                      10.4 \*  
 beste Teiler 74.8 (15.) 90.6 (19.) 95.0 (16.)  
 Trefferlage 0.11 mm rechts, 0.28 mm tief  
 Streuwert 1.29, horizontal: 1.70, vertikal: 0.67

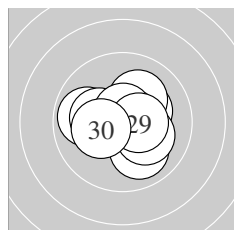

Serie 3:  
 10.3 \*                      10.1 ↗                      10.0 ↘                      9.9 ←                      10.6 \*  
 10.2 \*                      10.7 \*                      10.2 \*                      10.5 \*                      10.3 \*  
 beste Teiler 69.1 (27.) 85.4 (25.) 121.1 (29.)  
 Trefferlage 0.00 mm , 0.04 mm hoch  
 Streuwert 1.35, horizontal: 1.60, vertikal: 1.04

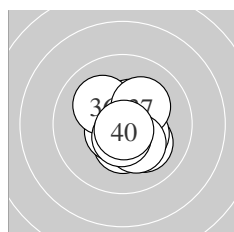

Serie 4:  
 10.1 ↘                      10.4 \*                      10.4 \*                      10.5 \*                      10.6 \*  
 10.1 ↘                      10.2 \*                      10.2 \*                      10.6 \*                      10.8 \*  
 beste Teiler 46.0 (40.) 84.9 (35.) 97.3 (39.)  
 Trefferlage 0.36 mm rechts, 0.31 mm tief  
 Streuwert 1.08, horizontal: 0.98, vertikal: 1.17

Unterschrift des Schützen

Ergebnis: **392.1** (375)  
 Serien: 100.2 100.2 96.0 95.7  
 Zähler: 18 19 3 0 0 0 0 0 0 0  
 Innenzehner: 13  
 weiteste: 749 (32), 745 (22), 554 (30)  
 beste Teiler 15.0 (9.) 50.0 (33.) 68.5 (23.)  
 Trefferlage 0.81 mm links, 0.33 mm hoch  
 Streuwert 2.29, horizontal: 2.49, vertikal: 2.06

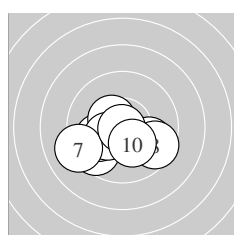
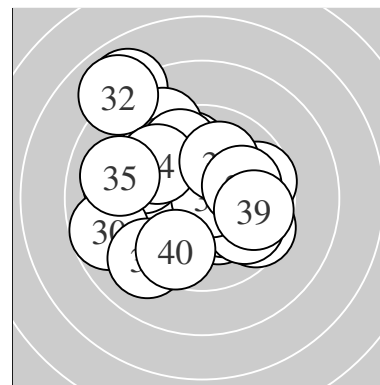

Serie 1:  
 9.6 ↙ 10.0 ↙ 10.2 \* 10.4 \* 9.8 ↘  
 10.3 \* 9.1 ↙ 9.6 ↘ 10.9 \* 10.3 \*  
 beste Teiler 15.0 (9.) 128.0 (4.) 163.7 (6.)  
 Trefferlage 0.35 mm links, 1.11 mm tief  
 Streuwert 1.76, horizontal: 2.32, vertikal: 0.90

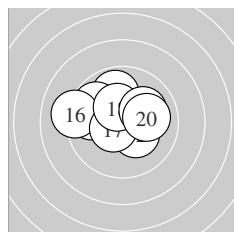

Serie 2:  
 9.8 ↖ 10.3 \* 9.9 ↗ 10.3 \* 9.8 ↘  
 9.1 ↖ 10.5 \* 10.4 \* 10.1 ↗ 10.0 →  
 beste Teiler 103.4 (17.) 149.0 (18.) 165.7 (12.)  
 Trefferlage 0.79 mm links, 0.78 mm hoch  
 Streuwert 1.70, horizontal: 2.16, vertikal: 1.06

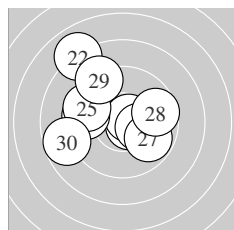

Serie 3:  
 10.7 \* 8.0 ↘ 10.7 \* 9.5 ↖ 9.5 ↘  
 10.3 \* 9.8 ↘ 9.7 → 9.1 ↘ 8.7 ↖  
 beste Teiler 68.5 (23.) 73.4 (21.) 161.3 (26.)  
 Trefferlage 1.02 mm links, 0.92 mm hoch  
 Streuwert 2.75, horizontal: 3.01, vertikal: 2.46

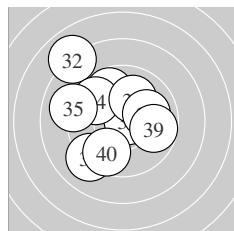

Serie 4:  
 9.7 ↖ 8.0 ↘ 10.8 \* 9.7 ↘ 9.0 ↖  
 9.1 ↙ 10.0 ↗ 10.0 → 9.8 → 9.6 ↙  
 beste Teiler 50.0 (33.) 227.6 (37.) 234.6 (38.)  
 Trefferlage 1.11 mm links, 0.74 mm hoch  
 Streuwert 2.71, horizontal: 2.71, vertikal: 2.71

Unterschrift des Schützen

Meyton Elektronik

Ergebnis: **416.2** (398)  
 Serien: 105.3 103.9 104.8 102.2  
 Zähler: 38 2 0 0 0 0 0 0 0 0  
 Innenzehner: 36  
 weiteste: 439 (34), 271 (39), 240 (5)  
 beste Teiler 15.0 (9.) 16.9 (7.) 40.8 (4.)  
 Trefferlage 0.05 mm rechts, 0.07 mm tief  
 Streuwert 1.11, horizontal: 1.25, vertikal: 0.94

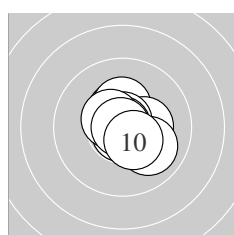
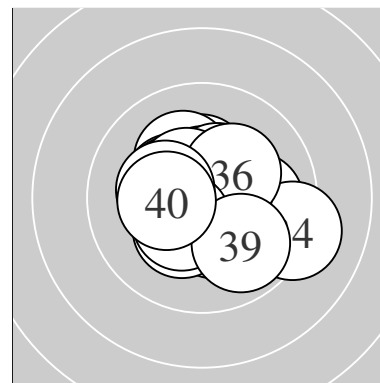

Serie 1:  
 10.4 \*                      10.3 \*                      10.3 \*                      10.8 \*                      10.0 ↘  
 10.8 \*                      10.9 \*                      10.5 \*                      10.9 \*                      10.4 \*  
 beste Teiler 15.0 (9.) 16.9 (7.) 40.8 (4.)  
 Trefferlage 0.25 mm rechts, 0.12 mm hoch  
 Streuwert 0.91, horizontal: 0.91, vertikal: 0.91

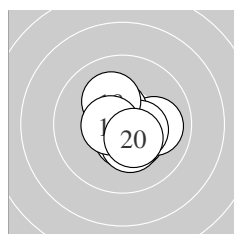

Serie 2:  
 10.4 \*                      10.0 →                      10.5 \*                      10.6 \*                      10.3 \*  
 10.5 \*                      10.4 \*                      10.2 \*                      10.6 \*                      10.4 \*  
 beste Teiler 81.8 (14.) 92.4 (19.) 106.4 (13.)  
 Trefferlage 0.30 mm rechts, 0.24 mm tief  
 Streuwert 1.04, horizontal: 1.08, vertikal: 1.01

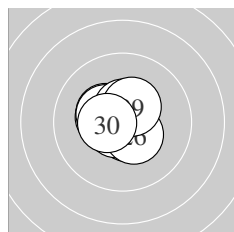

Serie 3:  
 10.5 \*                      10.4 \*                      10.4 \*                      10.6 \*                      10.7 \*  
 10.4 \*                      10.4 \*                      10.5 \*                      10.4 \*                      10.5 \*  
 beste Teiler 67.9 (25.) 83.6 (24.) 103.1 (28.)  
 Trefferlage 0.47 mm links, 0.21 mm hoch  
 Streuwert 0.82, horizontal: 0.89, vertikal: 0.74

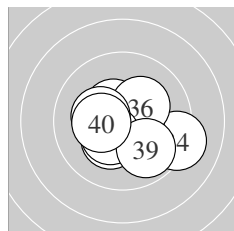

Serie 4:  
 10.5 \*                      10.3 \*                      10.5 \*                      9.2 ↘                      10.6 \*  
 10.2 \*                      10.4 \*                      10.3 \*                      9.9 ↘                      10.3 \*  
 beste Teiler 93.0 (35.) 112.9 (33.) 118.6 (31.)  
 Trefferlage 0.12 mm rechts, 0.41 mm tief  
 Streuwert 1.53, horizontal: 1.87, vertikal: 1.08

Unterschrift des Schützen

Ergebnis: **409.4** (392)  
 Serien: 101.7 102.5 103.7 101.5  
 Zähler: 32 8 0 0 0 0 0 0 0 0  
 Innenzehner: 27  
 weiteste: 407 (5), 363 (15), 323 (35)  
 beste Teiler 51.0 (21.) 55.0 (23.) 59.4 (20.)  
 Trefferlage 0.04 mm rechts, 0.10 mm hoch  
 Streuwert 1.42, horizontal: 1.61, vertikal: 1.18

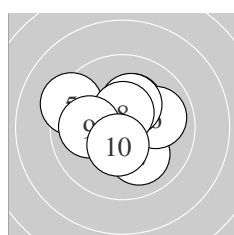
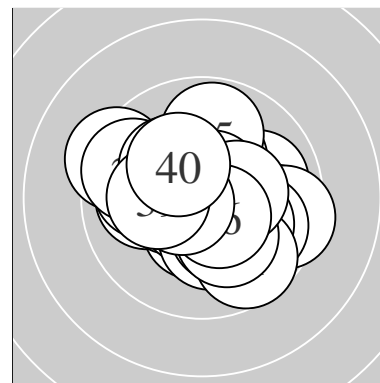

Serie 1:  
 10.3 \*                      10.0 ↘                      10.2 \*                      10.7 \*                      9.3 ↖  
 10.0 →                      10.3 \*                      10.5 \*                      10.0 ←                      10.4 \*  
 beste Teiler 62.8 (4.) 106.0 (8.) 133.4 (10.)  
 Trefferlage 0.30 mm links, 0.41 mm hoch  
 Streuwert 1.55, horizontal: 1.80, vertikal: 1.24

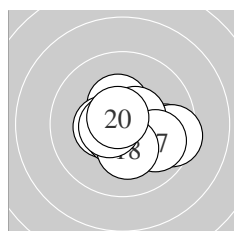

Serie 2:  
 10.4 \*                      10.4 \*                      9.7 →                      10.6 \*                      9.5 →  
 10.5 \*                      9.9 ↘                      10.2 \*                      10.6 \*                      10.7 \*  
 beste Teiler 59.4 (20.) 81.0 (14.) 95.7 (19.)  
 Trefferlage 0.67 mm rechts, 0.32 mm tief  
 Streuwert 1.38, horizontal: 1.73, vertikal: 0.92

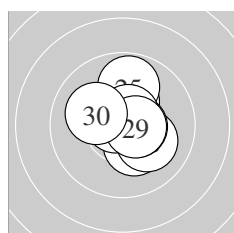

Serie 3:  
 10.7 \*                      10.3 \*                      10.7 \*                      10.2 \*                      9.8 ↑  
 10.1 ↘                      10.6 \*                      10.6 \*                      10.6 \*                      10.1 ↖  
 beste Teiler 51.0 (21.) 55.0 (23.) 80.2 (28.)  
 Trefferlage 0.33 mm rechts, 0.39 mm hoch  
 Streuwert 1.12, horizontal: 1.00, vertikal: 1.24

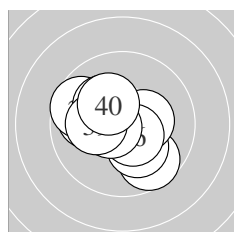

Serie 4:  
 9.7 ↘                      10.2 \*                      10.3 \*                      9.9 ←                      9.7 ↖  
 10.5 \*                      10.6 \*                      10.2 \*                      10.2 \*                      10.2 \*  
 beste Teiler 88.0 (37.) 109.6 (36.) 151.9 (33.)  
 Trefferlage 0.54 mm links, 0.05 mm tief  
 Streuwert 1.54, horizontal: 1.74, vertikal: 1.31

Unterschrift des Schützen

Meyton Elektronik



Ergebnis: **404.8** (388)  
 Serien: 100.4 102.0 100.3 102.1  
 Zähler: 28 12 0 0 0 0 0 0 0 0  
 Innenzehner: 17  
 weiteste: 436 (8), 396 (16), 371 (9)  
 beste Teiler 15.2 (19.) 32.3 (39.) 39.3 (27.)  
 Trefferlage 0.08 mm links, 0.22 mm tief  
 Streuwert 1.65, horizontal: 2.00, vertikal: 1.21

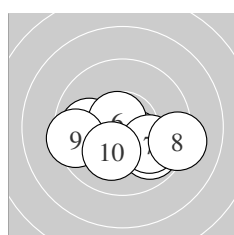
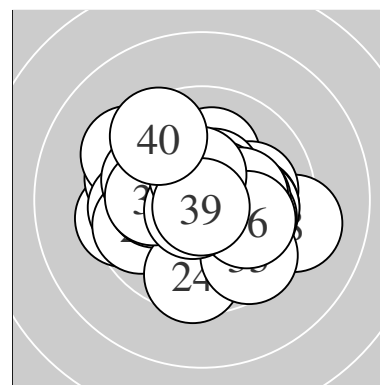

Serie 1:  
 10.2 \* 10.4 \* 9.9 ↘ 9.9 ← 10.5 \*  
 10.7 \* 10.0 ↘ 9.2 → 9.5 ← 10.1 ↙  
 beste Teiler 64.6 (6.) 110.1 (5.) 128.7 (2.)  
 Trefferlage 0.06 mm rechts, 0.87 mm tief  
 Streuwert 1.76, horizontal: 2.38, vertikal: 0.73

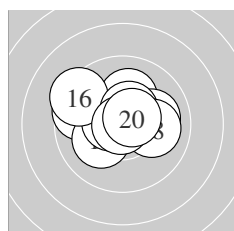

Serie 2:  
 9.6 ↖ 10.2 \* 10.6 \* 10.1 ↑ 10.1 →  
 9.4 ↖ 10.5 \* 10.0 → 10.9 \* 10.6 \*  
 beste Teiler 15.2 (19.) 87.6 (20.) 92.7 (13.)  
 Trefferlage 0.31 mm links, 0.57 mm hoch  
 Streuwert 1.56, horizontal: 1.97, vertikal: 1.01

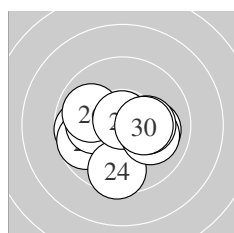

Serie 3:  
 9.7 ← 9.7 ← 10.1 ← 9.6 ↓ 10.0 →  
 9.9 ↖ 10.8 \* 10.0 → 10.2 \* 10.3 \*  
 beste Teiler 39.3 (27.) 164.0 (30.) 185.0 (29.)  
 Trefferlage 0.30 mm links, 0.48 mm tief  
 Streuwert 1.75, horizontal: 2.17, vertikal: 1.19

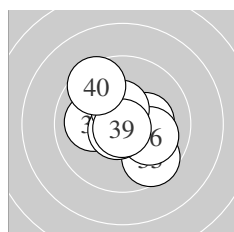

Serie 4:  
 10.0 ↘ 10.6 \* 9.6 ↘ 10.3 \* 10.1 ←  
 10.0 → 10.7 \* 10.5 \* 10.8 \* 9.5 ↘  
 beste Teiler 32.3 (39.) 64.4 (37.) 96.0 (32.)  
 Trefferlage 0.20 mm rechts, 0.12 mm tief  
 Streuwert 1.58, horizontal: 1.68, vertikal: 1.47

Unterschrift des Schützen

Meyton Elektronik

Ergebnis: **411.2** (394)  
 Serien: 102.5 102.0 104.3 102.4  
 Zähler: 34 6 0 0 0 0 0 0 0 0  
 Innenzehner: 27  
 weiteste: 344 (34), 296 (17), 268 (13)  
 beste Teiler 60.4 (28.) 63.2 (27.) 67.1 (26.)  
 Trefferlage 0.05 mm links, 0.19 mm hoch  
 Streuwert 1.29, horizontal: 1.37, vertikal: 1.21

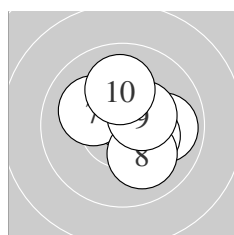
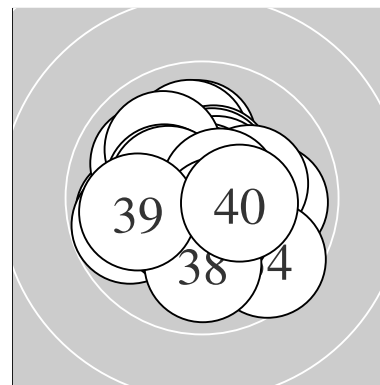

Serie 1:  
 10.5 \* 10.6 \* 10.2 \* 10.4 \* 9.9 →  
 10.3 \* 10.1 ↖ 10.1 ↘ 10.4 \* 10.0 ↑  
 beste Teiler 76.6 (2.) 104.5 (1.) 138.6 (9.)  
 Trefferlage 0.62 mm rechts, 0.43 mm hoch  
 Streuwert 1.23, horizontal: 1.31, vertikal: 1.15

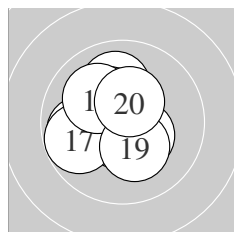

Serie 2:  
 10.2 \* 10.0 ↑ 9.9 ← 10.3 \* 10.6 \*  
 10.4 \* 9.8 ← 10.1 ↖ 10.3 \* 10.4 \*  
 beste Teiler 82.0 (15.) 138.1 (20.) 138.2 (16.)  
 Trefferlage 0.72 mm links, 0.30 mm hoch  
 Streuwert 1.37, horizontal: 1.33, vertikal: 1.40

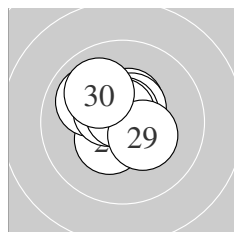

Serie 3:  
 10.4 \* 10.5 \* 10.0 ↖ 10.5 \* 10.5 \*  
 10.7 \* 10.7 \* 10.7 \* 10.3 \* 10.0 ↖  
 beste Teiler 60.4 (28.) 63.2 (27.) 67.1 (26.)  
 Trefferlage 0.33 mm links, 0.59 mm hoch  
 Streuwert 0.96, horizontal: 1.00, vertikal: 0.91

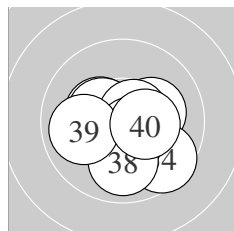

Serie 4:  
 10.3 \* 10.4 \* 10.2 \* 9.6 ↘ 10.6 \*  
 10.5 \* 10.6 \* 9.9 ↓ 9.9 ← 10.4 \*  
 beste Teiler 80.7 (35.) 90.7 (37.) 120.5 (36.)  
 Trefferlage 0.22 mm rechts, 0.53 mm tief  
 Streuwert 1.38, horizontal: 1.57, vertikal: 1.17

Unterschrift des Schützen

Ergebnis: **412.1** (394)  
 Serien: 102.9 105.3 101.5 102.4  
 Zähler: 34 6 0 0 0 0 0 0 0 0  
 Innenzehner: 29  
 weiteste: 470 (25), 347 (7), 319 (32)  
 beste Teiler 3.1 (15.) 27.0 (12.) 38.0 (3.)  
 Trefferlage 0.13 mm rechts, 0.14 mm tief  
 Streuwert 1.34, horizontal: 1.61, vertikal: 1.01

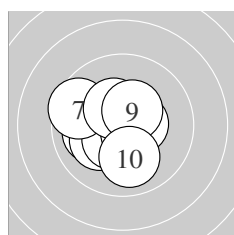
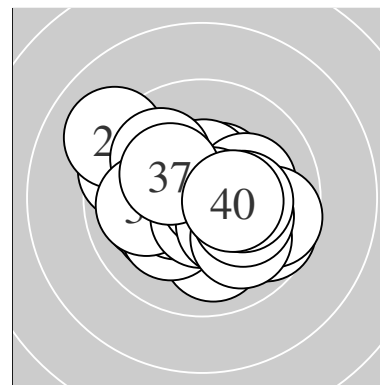

Serie 1:  
 10.0 ←                      10.2 \*                      10.8 \*                      10.4 \*                      10.6 \*  
 10.5 \*                      9.6 ↖                      10.4 \*                      10.4 \*                      10.0 ↓  
 beste Teiler 38.0 (3.) 82.2 (5.) 114.4 (6.)  
 Trefferlage 0.54 mm links, 0.22 mm tief  
 Streuwert 1.31, horizontal: 1.44, vertikal: 1.16

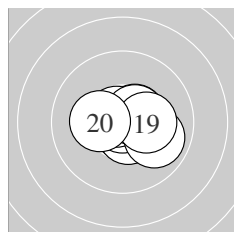

Serie 2:  
 10.5 \*                      10.8 \*                      10.8 \*                      10.6 \*                      10.9 \*  
 10.7 \*                      10.5 \*                      9.9 ↘                      10.3 \*                      10.3 \*  
 beste Teiler 3.1 (15.) 27.0 (12.) 49.2 (13.)  
 Trefferlage 0.39 mm rechts, 0.10 mm tief  
 Streuwert 0.90, horizontal: 1.15, vertikal: 0.57

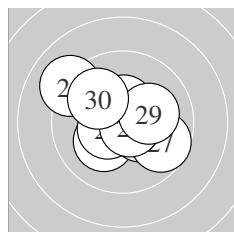

Serie 3:  
 10.2 \*                      10.4 \*                      10.5 \*                      10.4 \*                      9.1 ↖  
 10.5 \*                      9.7 ↘                      10.7 \*                      10.1 →                      9.9 ↖  
 beste Teiler 62.7 (28.) 120.0 (23.) 123.2 (26.)  
 Trefferlage 0.04 mm links, 0.25 mm hoch  
 Streuwert 1.71, horizontal: 2.01, vertikal: 1.36

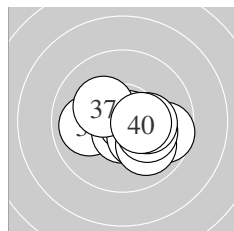

Serie 4:  
 10.0 ←                      9.7 →                      10.6 \*                      10.8 \*                      10.3 \*  
 10.0 ↘                      10.2 \*                      10.2 \*                      10.2 \*                      10.4 \*  
 beste Teiler 40.0 (34.) 85.0 (33.) 136.7 (40.)  
 Trefferlage 0.73 mm rechts, 0.49 mm tief  
 Streuwert 1.29, horizontal: 1.66, vertikal: 0.77

Unterschrift des Schützen

Meyton Elektronik

Ergebnis: **414.9** (398)  
 Serien: 104.3 103.9 101.7 105.0  
 Zähler: 38 2 0 0 0 0 0 0 0 0  
 Innenzehner: 36  
 weiteste: 387 (25), 297 (19), 250 (18)  
 beste Teiler 7.2 (32.) 28.0 (31.) 53.0 (17.)  
 Trefferlage 0.01 mm rechts, 0.11 mm hoch  
 Streuwert 1.14, horizontal: 1.31, vertikal: 0.94

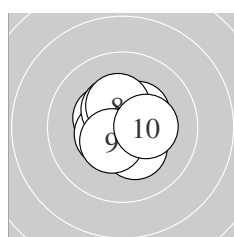
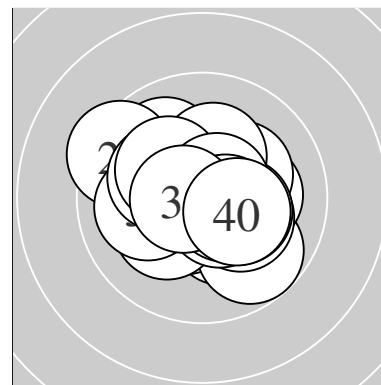

Serie 1:  
 10.4 \*                      10.5 \*                      10.4 \*                      10.4 \*                      10.5 \*  
 10.7 \*                      10.3 \*                      10.3 \*                      10.5 \*                      10.3 \*  
 beste Teiler 65.2 (6.) 106.5 (5.) 121.8 (9.)  
 Trefferlage 0.08 mm rechts, 0.04 mm hoch  
 Streuwert 1.00, horizontal: 1.02, vertikal: 0.99

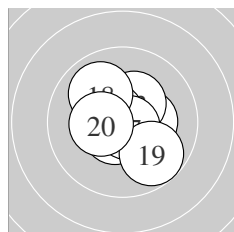

Serie 2:  
 10.6 \*                      10.3 \*                      10.3 \*                      10.6 \*                      10.6 \*  
 10.6 \*                      10.7 \*                      10.0 ↘                      9.8 ↘                      10.4 \*  
 beste Teiler 53.0 (17.) 82.4 (11.) 88.6 (15.)  
 Trefferlage 0.01 mm rechts, 0.01 mm hoch  
 Streuwert 1.19, horizontal: 1.24, vertikal: 1.15

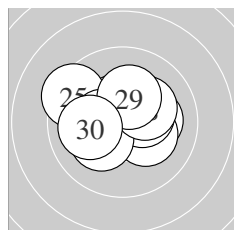

Serie 3:  
 10.2 \*                      10.5 \*                      10.2 \*                      10.4 \*                      9.4 ↖  
 10.4 \*                      10.2 \*                      10.2 \*                      10.2 \*                      10.0 ←  
 beste Teiler 118.5 (22.) 136.1 (26.) 145.7 (24.)  
 Trefferlage 0.20 mm links, 0.38 mm hoch  
 Streuwert 1.51, horizontal: 1.88, vertikal: 1.02

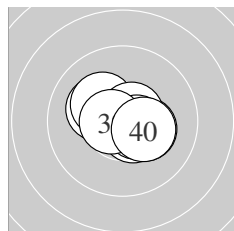

Serie 4:  
 10.8 \*                      10.9 \*                      10.3 \*                      10.2 \*                      10.6 \*  
 10.2 \*                      10.6 \*                      10.5 \*                      10.6 \*                      10.3 \*  
 beste Teiler 7.2 (32.) 28.0 (31.) 77.8 (37.)  
 Trefferlage 0.17 mm rechts, 0.01 mm hoch  
 Streuwert 0.92, horizontal: 1.14, vertikal: 0.63

Unterschrift des Schützen

Ergebnis: **401.8** (381)  
 Serien: 95.5 101.0 102.5 102.8  
 Zähler: 24 13 3 0 0 0 0 0 0 0  
 Innenzehner: 23  
 weiteste: 628 (25), 599 (5), 588 (8)  
 beste Teiler 19.9 (29.) 25.2 (34.) 35.0 (22.)  
 Trefferlage 1.05 mm links, 0.25 mm tief  
 Streuwert 1.81, horizontal: 1.86, vertikal: 1.77

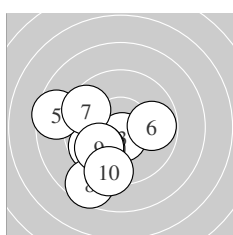
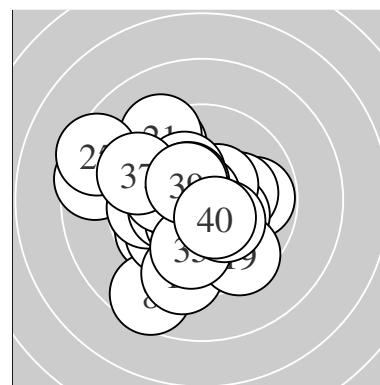

Serie 1:  
 9.6 ↙                  9.7 ↙                  10.6 \*                  9.9 ↙                  8.6 ←  
 9.8 →                  9.5 ↖                  8.6 ↙                  9.9 ↙                  9.3 ↓  
 beste Teiler 93.0 (3.) 271.6 (4.) 272.3 (9.)  
 Trefferlage 1.81 mm links, 1.57 mm tief  
 Streuwert 2.21, horizontal: 2.26, vertikal: 2.15

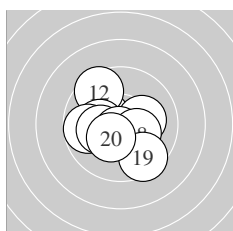

Serie 2:  
 10.3 \*                  9.5 ↖                  10.2 \*                  10.2 \*                  9.7 ←  
 10.2 \*                  10.7 \*                  10.3 \*                  9.5 ↘                  10.4 \*  
 beste Teiler 65.2 (17.) 149.6 (20.) 162.7 (11.)  
 Trefferlage 0.57 mm links, 0.24 mm tief  
 Streuwert 1.68, horizontal: 1.81, vertikal: 1.53

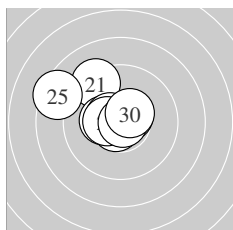

Serie 3:  
 9.3 ↖                  10.8 \*                  10.7 \*                  10.3 \*                  8.4 ↖  
 10.5 \*                  10.5 \*                  10.6 \*                  10.9 \*                  10.5 \*  
 beste Teiler 19.9 (29.) 35.0 (22.) 62.2 (23.)  
 Trefferlage 1.04 mm links, 0.79 mm hoch  
 Streuwert 1.63, horizontal: 1.94, vertikal: 1.25

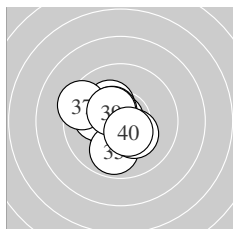

Serie 4:  
 10.5 \*                  10.1 ←                  10.2 \*                  10.9 \*                  9.9 ↓  
 10.3 \*                  9.4 ↖                  10.5 \*                  10.5 \*                  10.5 \*  
 beste Teiler 25.2 (34.) 102.7 (31.) 119.4 (38.)  
 Trefferlage 0.77 mm links, 0.00 mm  
 Streuwert 1.33, horizontal: 1.34, vertikal: 1.33

Unterschrift des Schützen

Meyton Elektronik

Ergebnis: **411.6** (397)  
 Serien: 104.6 103.1 102.4 101.5  
 Zähler: 37 3 0 0 0 0 0 0 0 0  
 Innenzehner: 26  
 weiteste: 400 (39), 274 (35), 262 (28)  
 beste Teiler 6.3 (3.) 46.3 (6.) 52.0 (16.)  
 Trefferlage 0.07 mm rechts, 0.13 mm tief  
 Streuwert 1.29, horizontal: 1.52, vertikal: 1.02

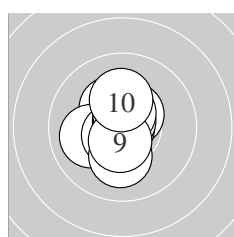
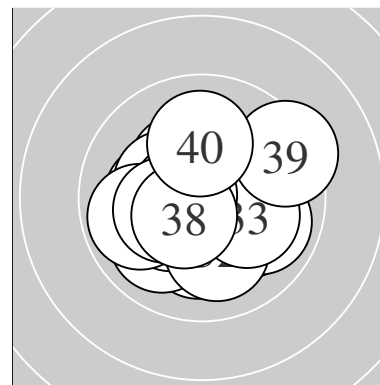

Serie 1:  
 10.3 \*                      10.5 \*                      10.9 \*                      10.0 ←                      10.6 \*  
 10.8 \*                      10.6 \*                      10.1 ↓                      10.6 \*                      10.2 \*  
 beste Teiler 6.3 (3.) 46.3 (6.) 87.3 (5.)  
 Trefferlage 0.32 mm links, 0.13 mm hoch  
 Streuwert 1.02, horizontal: 0.79, vertikal: 1.21

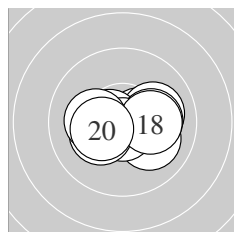

Serie 2:  
 10.5 \*                      10.1 →                      10.6 \*                      10.1 ↘                      10.1 →  
 10.7 \*                      10.3 \*                      10.2 \*                      10.2 \*                      10.3 \*  
 beste Teiler 52.0 (16.) 91.2 (13.) 117.5 (11.)  
 Trefferlage 0.33 mm rechts, 0.18 mm tief  
 Streuwert 1.24, horizontal: 1.68, vertikal: 0.53

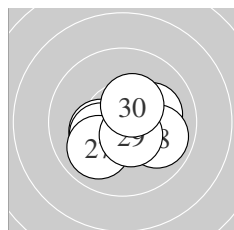

Serie 3:  
 10.3 \*                      10.1 →                      10.6 \*                      10.3 \*                      10.2 \*  
 10.1 →                      10.0 ←                      9.9 →                      10.5 \*                      10.4 \*  
 beste Teiler 91.0 (23.) 109.2 (29.) 137.0 (30.)  
 Trefferlage 0.55 mm rechts, 0.41 mm tief  
 Streuwert 1.29, horizontal: 1.60, vertikal: 0.86

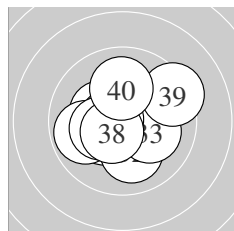

Serie 4:  
 10.3 \*                      10.1 ↓                      10.1 →                      10.3 \*                      9.9 ←  
 10.6 \*                      10.3 \*                      10.5 \*                      9.4 →                      10.0 ↑  
 beste Teiler 76.9 (36.) 106.7 (38.) 156.4 (31.)  
 Trefferlage 0.25 mm links, 0.08 mm tief  
 Streuwert 1.61, horizontal: 1.84, vertikal: 1.36

Unterschrift des Schützen

Ergebnis: **407.5** (386)  
 Serien: 102.5 101.3 100.7 103.0  
 Zähler: 26 14 0 0 0 0 0 0 0 0  
 Innenzehner: 24  
 weiteste: 410 (27), 375 (7), 375 (20)  
 beste Teiler 42.5 (8.) 46.0 (6.) 47.4 (21.)  
 Trefferlage 0.04 mm links, 0.39 mm tief  
 Streuwert 1.55, horizontal: 1.96, vertikal: 0.97

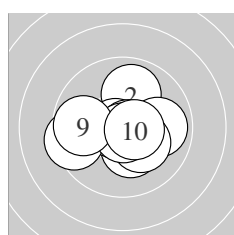
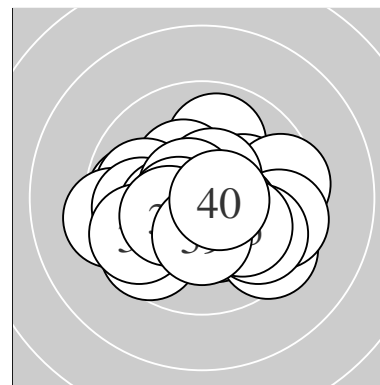

Serie 1:  
 10.3 \* 9.9 ↑ 9.9 → 10.7 \* 10.2 \*  
 10.8 \* 9.5 ← 10.8 \* 9.8 ← 10.6 \*  
 beste Teiler 42.5 (8.) 46.0 (6.) 54.9 (4.)  
 Trefferlage 0.05 mm links, 0.20 mm tief  
 Streuwert 1.55, horizontal: 1.90, vertikal: 1.08

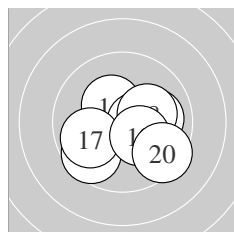

Serie 2:  
 10.4 \* 10.0 → 10.6 \* 10.3 \* 9.6 ↙  
 10.5 \* 9.9 ← 10.2 \* 10.3 \* 9.5 ↘  
 beste Teiler 98.0 (13.) 107.0 (16.) 143.7 (11.)  
 Trefferlage 0.21 mm rechts, 0.44 mm tief  
 Streuwert 1.64, horizontal: 1.95, vertikal: 1.27

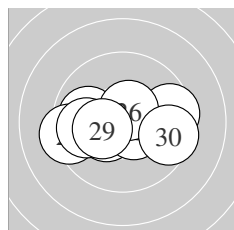

Serie 3:  
 10.8 \* 9.5 → 10.4 \* 9.9 ← 10.5 \*  
 10.6 \* 9.3 ← 9.9 ← 10.3 \* 9.5 →  
 beste Teiler 47.4 (21.) 98.8 (26.) 101.5 (25.)  
 Trefferlage 0.33 mm links, 0.19 mm tief  
 Streuwert 1.86, horizontal: 2.54, vertikal: 0.67

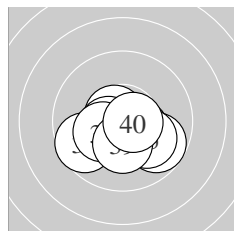

Serie 4:  
 9.8 ↘ 10.7 \* 9.6 ↙ 10.4 \* 10.1 ↘  
 10.7 \* 10.5 \* 10.3 \* 10.3 \* 10.6 \*  
 beste Teiler 63.6 (32.) 75.2 (36.) 78.6 (40.)  
 Trefferlage 0.02 mm links, 0.76 mm tief  
 Streuwert 1.27, horizontal: 1.63, vertikal: 0.77

Unterschrift des Schützen

Meyton Elektronik

Ergebnis: **416.2** (398)  
 Serien: 104.3 104.1 103.8 104.0  
 Zähler: 38 2 0 0 0 0 0 0 0 0  
 Innenzehner: 34  
 weiteste: 370 (35), 264 (20), 242 (24)  
 beste Teiler 28.2 (16.) 41.7 (2.) 62.3 (10.)  
 Trefferlage 0.13 mm links, 0.02 mm hoch  
 Streuwert 1.09, horizontal: 1.21, vertikal: 0.95

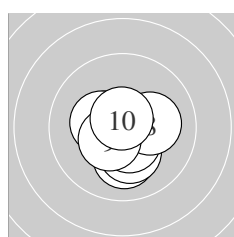
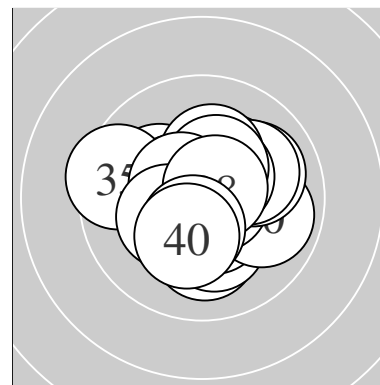

Serie 1:  
 10.1 ↓                      10.8 \*                      10.2 \*                      10.5 \*                      10.6 \*  
 10.5 \*                      10.3 \*                      10.2 \*                      10.4 \*                      10.7 \*  
 beste Teiler 41.7 (2.) 62.3 (10.) 80.3 (5.)  
 Trefferlage 0.14 mm links, 0.44 mm tief  
 Streuwert 0.99, horizontal: 1.02, vertikal: 0.97

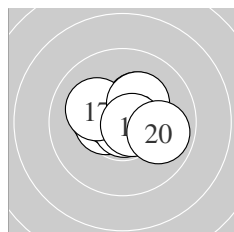

Serie 2:  
 10.3 \*                      10.3 \*                      10.5 \*                      10.7 \*                      10.5 \*  
 10.8 \*                      10.1 ↖                      10.3 \*                      10.7 \*                      9.9 →  
 beste Teiler 28.2 (16.) 69.4 (14.) 69.9 (19.)  
 Trefferlage 0.11 mm rechts, 0.39 mm hoch  
 Streuwert 1.09, horizontal: 1.37, vertikal: 0.70

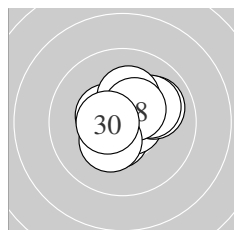

Serie 3:  
 10.5 \*                      10.5 \*                      10.7 \*                      10.0 →                      10.5 \*  
 10.1 ↗                      10.2 \*                      10.5 \*                      10.3 \*                      10.5 \*  
 beste Teiler 63.3 (23.) 101.2 (21.) 107.0 (30.)  
 Trefferlage 0.20 mm rechts, 0.19 mm hoch  
 Streuwert 1.12, horizontal: 1.20, vertikal: 1.03

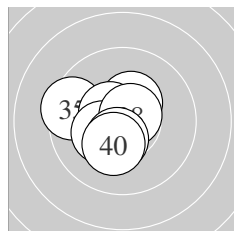

Serie 4:  
 10.6 \*                      10.6 \*                      10.7 \*                      10.4 \*                      9.5 ←  
 10.5 \*                      10.3 \*                      10.7 \*                      10.4 \*                      10.3 \*  
 beste Teiler 65.5 (33.) 70.6 (38.) 77.1 (32.)  
 Trefferlage 0.70 mm links, 0.05 mm tief  
 Streuwert 1.10, horizontal: 1.19, vertikal: 0.99

Unterschrift des Schützen