

Ergebnis: **585.4** (561)
 Serien: 97.3 97.2 97.4 101.2 96.7 95.6
 Zähler: 26 29 5 0 0 0 0 0 0
 Innenzehner: 19
 Weitestе: 695 (22.), 689 (46.), 594 (16.)
 beste Teiler: 91.2 (36.), 91.6 (44.), 101.4 (43.)
 Trefferlage: 0.36 mm links, 0.05 mm hoch
 Streuwert: 2.36, horizontal: 2.91, vertikal: 1.65

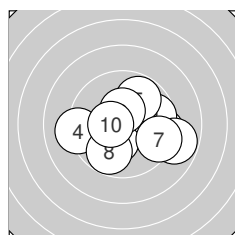

Serie 1:
 10.3 * 9.4 → 9.7 → 9.2 ← 9.8 ↗
 8.8 → 9.4 → 9.8 ↘ 10.4 * 10.5 *
 beste Teiler: 117.0 (10.), 131.0 (9.), 172.5 (1.)
 Trefferlage: 0.94 mm rechts, 0.41 mm tief
 Streuwert: 2.35, horizontal: 2.94, vertikal: 1.56

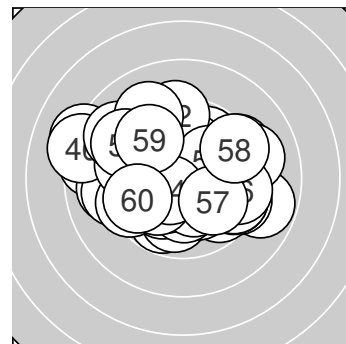
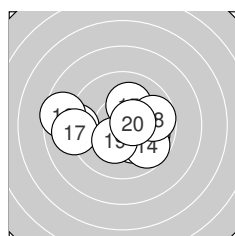

Serie 2:
 10.2 * 9.9 → 9.1 ← 9.7 ↘ 10.1 ↗
 8.6 ← 9.1 ← 9.7 → 10.3 * 10.5 *
 beste Teiler: 103.0 (20.), 167.2 (19.), 177.5 (11.)
 Trefferlage: 0.55 mm links, 0.27 mm tief
 Streuwert: 2.48, horizontal: 3.29, vertikal: 1.24

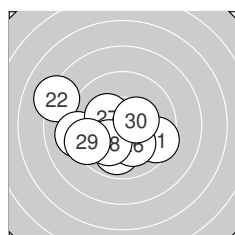

Serie 3:
 9.5 → 8.2 ↖ 9.2 ← 9.9 ↓ 10.3 *
 10.1 ↘ 10.3 * 10.1 ↗ 9.4 ← 10.4 *
 beste Teiler: 142.4 (30.), 169.9 (25.), 171.0 (27.)
 Trefferlage: 1.11 mm links, 0.75 mm tief
 Streuwert: 2.38, horizontal: 2.97, vertikal: 1.58

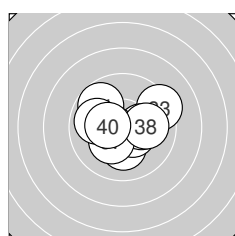

Serie 4:
 10.2 * 10.5 * 9.3 ↗ 9.8 ↘ 10.2 *
 10.6 * 10.3 * 10.0 → 9.9 ← 10.4 *
 beste Teiler: 91.2 (36.), 121.8 (32.), 146.9 (40.)
 Trefferlage: 0.07 mm rechts, 0.06 mm hoch
 Streuwert: 1.70, horizontal: 2.04, vertikal: 1.28

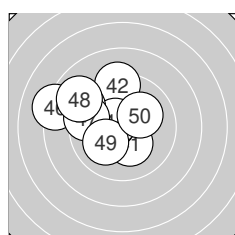

Serie 5:
 10.3 * 9.3 ↑ 10.5 * 10.6 * 9.2 ↖
 8.2 ↖ 9.5 ← 8.9 ↖ 10.1 ↗ 10.1 ↗
 beste Teiler: 91.6 (44.), 101.4 (43.), 173.6 (41.)
 Trefferlage: 1.97 mm links, 1.06 mm hoch
 Streuwert: 2.20, horizontal: 2.55, vertikal: 1.77

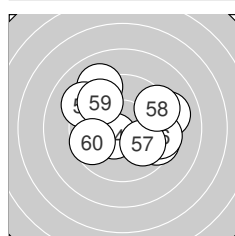

Serie 6:
 9.1 → 9.1 ↘ 9.2 ↖ 10.5 * 9.5 →
 9.5 → 10.0 ↘ 9.4 ↗ 9.6 ↖ 9.7 ←
 beste Teiler: 115.3 (54.), 245.2 (57.), 325.4 (60.)
 Trefferlage: 0.46 mm rechts, 0.64 mm hoch
 Streuwert: 2.65, horizontal: 3.16, vertikal: 2.01

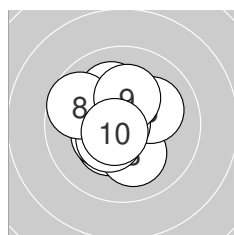
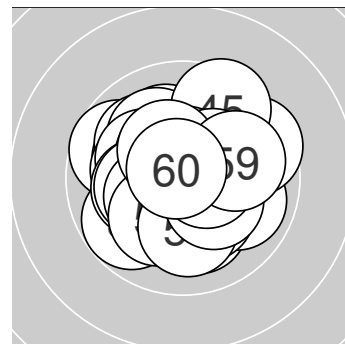

Ergebnis: **619.6** (595)
 Serien: 102.9 103.9 102.2 103.7 102.6 104.3
 Zähler: 55 5 0 0 0 0 0 0 0
 Innenzehner: 44
 Weitest: 353 (45.), 344 (27.), 312 (8.)
 beste Teiler: 36.8 (35.), 38.1 (6.), 47.2 (14.)
 Trefferlage: 0.06 mm links, 0.12 mm hoch
 Streuwert: 1.22, horizontal: 1.27, vertikal: 1.17

**Serie 1:**

10.4 *	10.4 *	10.1 ↓	10.4 *	10.1 →
10.8 *	10.1 ↖	9.7 ↗	10.2 *	10.7 *

beste Teiler: 38.1 (6.), 74.9 (10.), 132.3 (4.)
 Trefferlage: 0.46 mm links, 0.06 mm hoch
 Streuwert: 1.31, horizontal: 1.26, vertikal: 1.35

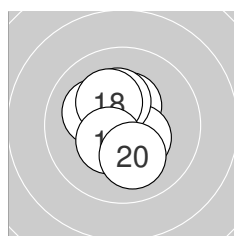
**Serie 2:**

10.4 *	10.6 *	10.6 *	10.8 *	10.4 *
10.3 *	10.1 ↗	10.2 *	10.4 *	10.1 ↓

beste Teiler: 47.2 (14.), 89.4 (13.), 93.9 (12.)
 Trefferlage: 0.26 mm links, 0.01 mm hoch
 Streuwert: 1.09, horizontal: 0.88, vertikal: 1.26

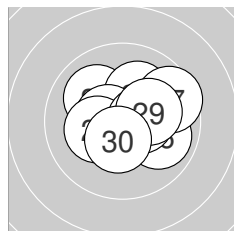
**Serie 3:**

10.0 ↘	10.7 *	10.1 ↗	10.6 *	10.2 *
9.9 ↘	9.6 ↗	10.5 *	10.2 *	10.4 *

beste Teiler: 75.8 (22.), 100.2 (24.), 121.2 (28.)
 Trefferlage: 0.52 mm rechts, 0.34 mm hoch
 Streuwert: 1.40, horizontal: 1.68, vertikal: 1.06

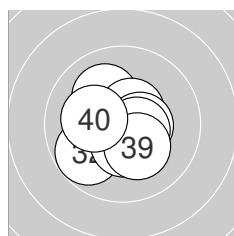
**Serie 4:**

10.1 ↖	9.8 ↖	10.4 *	10.7 *	10.8 *
10.5 *	10.5 *	10.5 *	10.2 *	10.2 *

beste Teiler: 36.8 (35.), 61.4 (34.), 102.0 (36.)
 Trefferlage: 0.07 mm links, 0.18 mm tief
 Streuwert: 1.19, horizontal: 1.26, vertikal: 1.13

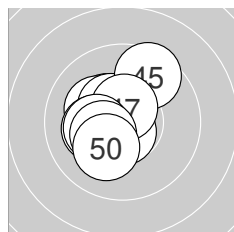
**Serie 5:**

10.7 *	10.4 *	10.2 *	10.4 *	9.5 ↗
10.2 *	10.6 *	10.2 *	10.3 *	10.1 ↖

beste Teiler: 65.0 (41.), 98.6 (47.), 129.0 (44.)
 Trefferlage: 0.77 mm links, 0.30 mm hoch
 Streuwert: 1.24, horizontal: 1.11, vertikal: 1.36

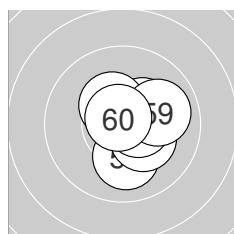
**Serie 6:**

10.5 *	10.3 *	10.7 *	10.1 ↓	10.3 *
10.8 *	10.4 *	10.5 *	10.0 →	10.7 *

beste Teiler: 49.3 (56.), 51.0 (60.), 57.2 (53.)
 Trefferlage: 0.68 mm rechts, 0.18 mm hoch
 Streuwert: 0.96, horizontal: 0.90, vertikal: 1.02

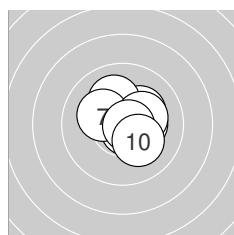
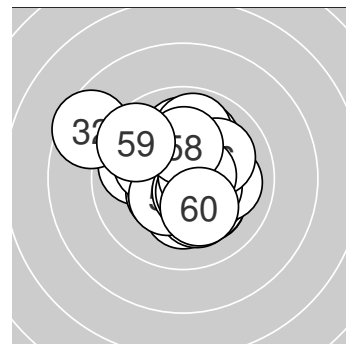

Ergebnis: **621.5** (595)
 Serien: 103.7 103.5 105.0 102.4^{OF} 103.5 103.4
 Zähler: 56 3 1 0 0 0 0 0 0
 Innenzehner: 51
 Weitestе: 596 (32.), 339 (59.), 271 (14.)
 beste Teiler: 11.6 (21.), 12.0 (35.), 38.0 (39.)
 Trefferlage: 0.18 mm rechts, 0.26 mm hoch
 Streuwert: 1.21, horizontal: 1.29, vertikal: 1.12

**Serie 1:**

10.2 *	10.6 *	10.4 *	10.3 *	10.7 *
10.1 ↖	10.2 *	10.3 *	10.7 *	10.2 *

beste Teiler: 54.1 (9.), 57.8 (5.), 78.7 (2.)
 Trefferlage: 0.53 mm rechts, 0.37 mm hoch
 Streuwert: 1.04, horizontal: 1.15, vertikal: 0.92

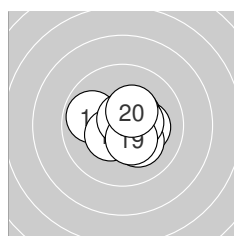
**Serie 2:**

10.5 *	10.2 *	10.4 *	9.9 ↖	10.4 *
10.2 *	10.7 *	10.4 *	10.4 *	10.4 *

beste Teiler: 53.0 (17.), 101.7 (11.), 132.1 (13.)
 Trefferlage: 0.40 mm rechts, 0.08 mm tief
 Streuwert: 1.14, horizontal: 1.33, vertikal: 0.92

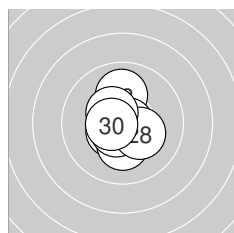
**Serie 3:**

10.9 *	10.7 *	10.0 ↑	10.5 *	10.8 *
10.2 *	10.6 *	10.3 *	10.4 *	10.6 *

beste Teiler: 11.6 (21.), 41.1 (25.), 65.7 (22.)
 Trefferlage: 0.17 mm links, 0.03 mm tief
 Streuwert: 0.97, horizontal: 0.74, vertikal: 1.15

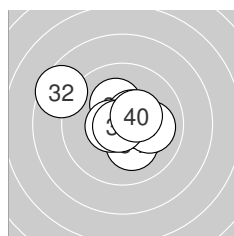
**Serie 4:**

10.2 *	8.6 ↖	10.2 *	10.2 *	10.9 *
10.5 *	10.0 →	10.6 *	10.8 *	10.4 *

beste Teiler: 12.0 (35.), 38.0 (39.), 100.4 (38.)
 Trefferlage: 0.04 mm links, 0.30 mm hoch
 Streuwert: 1.74, horizontal: 2.12, vertikal: 1.26

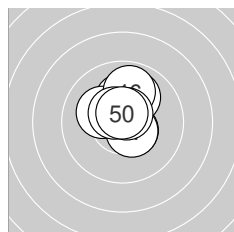
**Serie 5:**

10.5 *	10.2 *	10.0 ↗	10.5 *	10.2 *
9.9 ↑	10.5 *	10.6 *	10.5 *	10.6 *

beste Teiler: 79.2 (50.), 79.6 (48.), 106.1 (49.)
 Trefferlage: 0.08 mm rechts, 0.94 mm hoch
 Streuwert: 0.98, horizontal: 0.84, vertikal: 1.11

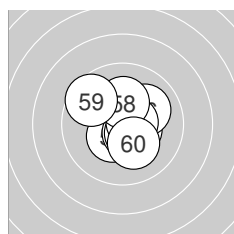
**Serie 6:**

10.4 *	10.7 *	10.6 *	10.5 *	10.5 *
10.1 ↗	10.6 *	10.2 *	9.6 ↖	10.2 *

beste Teiler: 65.1 (52.), 83.3 (57.), 89.8 (53.)
 Trefferlage: 0.31 mm rechts, 0.06 mm hoch
 Streuwert: 1.27, horizontal: 1.28, vertikal: 1.26



ISSF AR Men – Wertung –

Männer

StartNr: 48

StandNr: 106

3. November 2022 11:19

Zott, Georg #70507092

AUT

QF

– Schütze hat sich fürs Finale qualifiziert



Ergebnis: **608.1** (580)
 Serien: 102.1 102.3 99.6 104.0 99.5 100.6
 Zähler: 42 16 2 0 0 0 0 0 0
 Innenzehner: 31
 Weitestе: 600 (45.), 529 (53.), 465 (21.)
 beste Teiler: 19.6 (36.), 23.0 (28.), 32.5 (15.)
 Trefferlage: 0.02 mm links, 0.09 mm tief
 Streuwert: 1.68, horizontal: 1.94, vertikal: 1.37

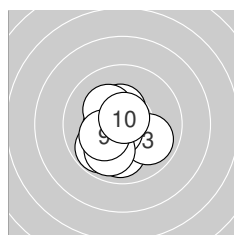
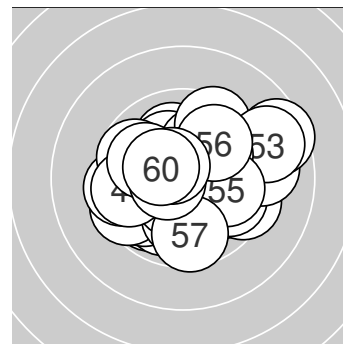

Serie 1:
 10.4 * 10.0 ↓ 9.9 ↘ 10.6 * 10.4 *
 9.8 ↗ 9.9 ↘ 10.2 * 10.2 * 10.7 *
 beste Teiler: 57.4 (10.), 76.2 (4.), 130.5 (1.)
 Trefferlage: 0.57 mm links, 0.68 mm tief
 Streuwert: 1.30, horizontal: 1.20, vertikal: 1.39

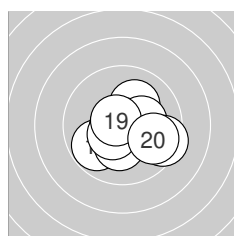

Serie 2:
 10.1 ↗ 9.8 ↘ 10.2 * 10.7 * 10.8 *
 10.3 * 10.5 * 9.4 ↘ 10.7 * 9.8 ↘
 beste Teiler: 32.5 (15.), 65.0 (14.), 71.6 (19.)
 Trefferlage: 0.41 mm rechts, 0.45 mm tief
 Streuwert: 1.50, horizontal: 1.79, vertikal: 1.13

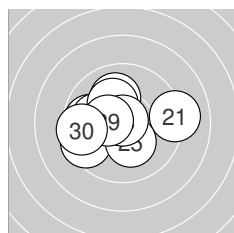

Serie 3:
 9.1 → 9.8 ← 10.0 ↑ 9.5 ↘ 10.2 *
 10.0 ← 10.2 * 10.9 * 10.4 * 9.5 ←
 beste Teiler: 23.0 (28.), 132.0 (29.), 177.7 (25.)
 Trefferlage: 0.95 mm links, 0.17 mm hoch
 Streuwert: 1.92, horizontal: 2.42, vertikal: 1.25

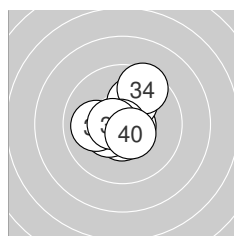

Serie 4:
 10.7 * 10.1 ↗ 10.7 * 9.5 ↗ 10.6 *
 10.9 * 10.4 * 10.0 ← 10.6 * 10.5 *
 beste Teiler: 19.6 (36.), 60.4 (33.), 71.3 (31.)
 Trefferlage: 0.11 mm links, 0.18 mm hoch
 Streuwert: 1.24, horizontal: 1.18, vertikal: 1.30

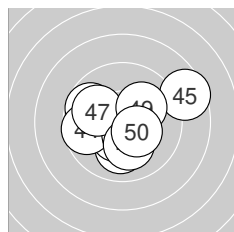

Serie 5:
 10.0 ↓ 9.7 ↖ 10.4 * 9.7 ← 8.6 →
 10.5 * 10.0 ↖ 10.1 ↓ 10.1 ↗ 10.4 *
 beste Teiler: 119.6 (46.), 136.5 (43.), 149.4 (50.)
 Trefferlage: 0.04 mm rechts, 0.21 mm tief
 Streuwert: 2.12, horizontal: 2.54, vertikal: 1.58

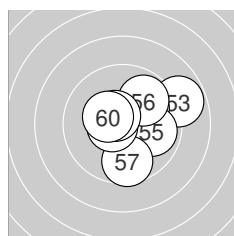

Serie 6:
 10.7 * 10.2 * 8.8 → 10.0 ↗ 9.9 →
 9.8 ↗ 9.6 ↓ 10.6 * 10.6 * 10.4 *
 beste Teiler: 72.7 (51.), 93.1 (58.), 97.6 (59.)
 Trefferlage: 1.03 mm rechts, 0.40 mm hoch
 Streuwert: 1.74, horizontal: 1.92, vertikal: 1.54



Ergebnis: **621.9** (593)
 Serien: 104.5 105.1 102.9 103.0^{OF} 104.1 102.3
 Zähler: 53 7 0 0 0 0 0 0 0
 Innenzehner: 46
 Weitest: 286 (55.), 275 (41.), 270 (10.)
 beste Teiler: 9.4 (36.), 26.0 (16.), 35.9 (29.)
 Trefferlage: 0.27 mm rechts, 0.09 mm hoch
 Streuwert: 1.15, horizontal: 1.18, vertikal: 1.11

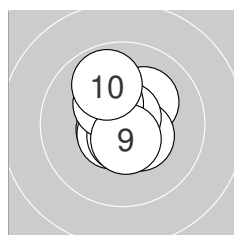
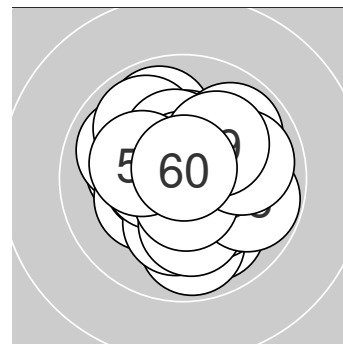

Serie 1:

10.6 *	10.6 *	10.2 *	10.4 *	10.6 *
10.5 *	10.8 *	10.3 *	10.6 *	9.9 ↗

beste Teiler: 49.6 (7.), 76.0 (5.), 79.2 (1.)
 Trefferlage: 0.09 mm links, 0.32 mm hoch
 Streuwert: 1.01, horizontal: 0.81, vertikal: 1.18

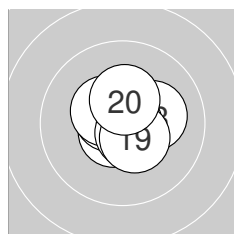

Serie 2:

10.4 *	10.6 *	10.2 *	10.6 *	10.6 *
10.8 *	10.4 *	10.6 *	10.5 *	10.4 *

beste Teiler: 26.0 (16.), 78.4 (18.), 79.7 (12.)
 Trefferlage: 0.18 mm rechts, 0.29 mm hoch
 Streuwert: 0.85, horizontal: 0.86, vertikal: 0.83

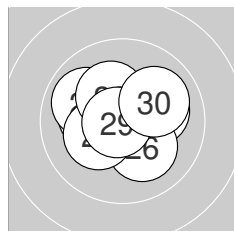

Serie 3:

10.2 *	10.7 *	9.9 ↖	10.5 *	10.1 →
10.1 ↘	10.3 *	10.3 *	10.8 *	10.0 →

beste Teiler: 35.9 (29.), 68.6 (22.), 117.9 (24.)
 Trefferlage: 0.14 mm links, 0.31 mm hoch
 Streuwert: 1.32, horizontal: 1.55, vertikal: 1.04

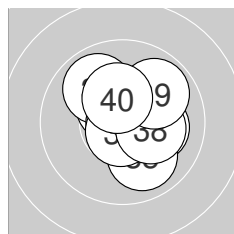

Serie 4:

10.5 *	10.5 *	9.9 ↖	10.1 →	10.0 ↘
10.9 *	10.7 *	10.2 *	9.9 ↗	10.3 *

beste Teiler: 9.4 (36.), 59.2 (37.), 123.2 (31.)
 Trefferlage: 0.47 mm rechts, 0.41 mm hoch
 Streuwert: 1.29, horizontal: 1.25, vertikal: 1.32

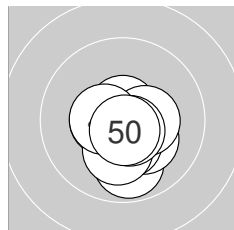

Serie 5:

9.9 ↓	10.2 *	10.4 *	10.7 *	10.5 *
10.4 *	10.2 *	10.6 *	10.5 *	10.7 *

beste Teiler: 60.0 (44.), 66.2 (50.), 81.5 (48.)
 Trefferlage: 0.14 mm rechts, 0.80 mm tief
 Streuwert: 0.95, horizontal: 0.87, vertikal: 1.02

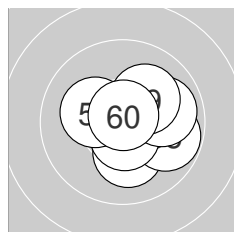

Serie 6:

10.0 →	10.5 *	10.2 *	10.2 *	9.8 →
10.6 *	9.9 →	10.2 *	10.1 ↗	10.8 *

beste Teiler: 43.2 (60.), 86.1 (56.), 119.5 (52.)
 Trefferlage: 1.06 mm rechts, 0.02 mm hoch
 Streuwert: 1.21, horizontal: 1.38, vertikal: 1.00



ISSF AR Men – Wertung –

Männer

StartNr: 50

StandNr: 108

3. November 2022 11:39

Schmirl, Alexander #166

AUT

QF

– Schütze hat sich fürs Finale qualifiziert

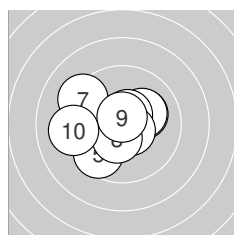
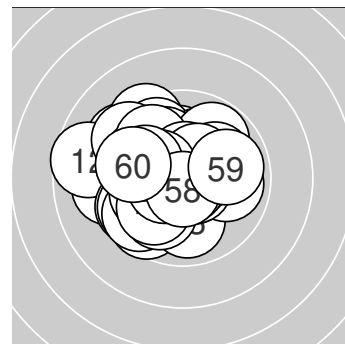

Ergebnis: **607.0** (580)
 Serien: 100.5 100.2 100.4 100.3 102.3 103.3
 Zähler: 41 18 1 0 0 0 0 0 0
 Innenzehner: 28
 Weitester: 575 (12.), 442 (10.), 419 (7.)
 beste Teiler: 3.1 (15.), 28.6 (50.), 51.8 (51.)
 Trefferlage: 0.59 mm links, 0.29 mm hoch
 Streuwert: 1.62, horizontal: 1.83, vertikal: 1.39

**Serie 1:**

10.1 ↗	10.2 *	10.6 *	9.8 ↖	9.6 ↙
10.6 *	9.3 ↘	10.4 *	10.7 *	9.2 ←

beste Teiler: 64.1 (9.), 88.0 (6.), 96.1 (3.)
 Trefferlage: 0.87 mm links, 0.15 mm hoch
 Streuwert: 1.84, horizontal: 2.20, vertikal: 1.38

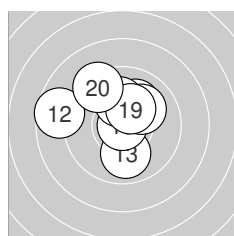
**Serie 2:**

10.3 *	8.7 ←	9.9 ↓	10.5 *	10.9 *
10.1 ↗	10.1 ↑	10.1 ↗	10.3 *	9.3 ↘

beste Teiler: 3.1 (15.), 119.8 (14.), 163.6 (19.)
 Trefferlage: 0.30 mm links, 1.13 mm hoch
 Streuwert: 1.87, horizontal: 2.15, vertikal: 1.54

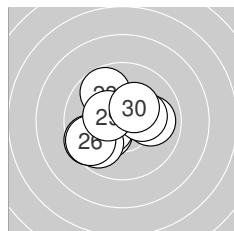
**Serie 3:**

9.6 ↙	10.3 *	10.4 *	9.8 ↙	10.0 →
9.6 ↙	10.2 *	9.8 ↘	10.4 *	10.3 *

beste Teiler: 140.4 (29.), 146.2 (23.), 160.3 (30.)
 Trefferlage: 0.82 mm links, 0.23 mm tief
 Streuwert: 1.70, horizontal: 1.92, vertikal: 1.46

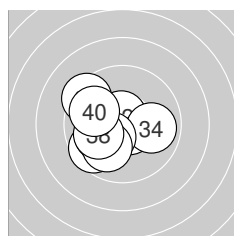
**Serie 4:**

10.6 *	10.7 *	9.6 ↙	9.9 →	10.0 ↙
10.3 *	10.0 ↙	10.0 ↙	9.4 ↘	9.8 ↘

beste Teiler: 73.9 (32.), 78.2 (31.), 157.1 (36.)
 Trefferlage: 1.19 mm links, 0.38 mm tief
 Streuwert: 1.60, horizontal: 1.77, vertikal: 1.41

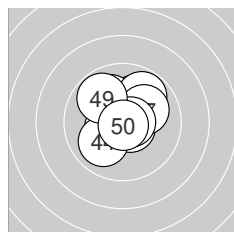
**Serie 5:**

10.6 *	10.1 ↗	10.4 *	10.0 ↙	10.0 ↘
9.8 ↗	10.1 ↗	10.7 *	9.8 ↘	10.8 *

beste Teiler: 28.6 (50.), 71.0 (48.), 82.9 (41.)
 Trefferlage: 0.02 mm rechts, 0.64 mm hoch
 Streuwert: 1.41, horizontal: 1.39, vertikal: 1.42

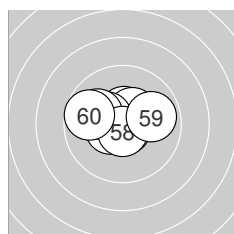
**Serie 6:**

10.7 *	10.6 *	10.5 *	10.4 *	10.3 *
10.5 *	10.0 ↖	10.7 *	9.9 →	9.7 ↖

beste Teiler: 51.8 (51.), 66.0 (58.), 91.0 (52.)
 Trefferlage: 0.38 mm links, 0.45 mm hoch
 Streuwert: 1.23, horizontal: 1.60, vertikal: 0.68



Ergebnis: **624.8** (595)
 Serien: 103.2 104.4 103.1 104.7^{OF} 105.7 103.7
 Zähler: 55 5 0 0 0 0 0 0 0
 Innenzehner: 48
 Weitester: 308 (11.), 290 (57.), 271 (7.)
 beste Teiler: 7.0 (21.), 19.7 (14.), 22.8 (12.)
 Trefferlage: 0.04 mm links, 0.24 mm hoch
 Streuwert: 1.08, horizontal: 1.01, vertikal: 1.15

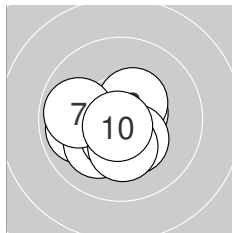
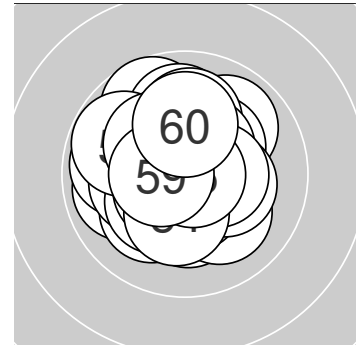

Serie 1:
 10.6 * 10.4 * 9.9 ←
 10.5 * 9.9 ← 10.3 *
 beste Teiler: 49.2 (10.), 89.0 (1.), 109.7 (6.)
 Trefferlage: 0.49 mm links, 0.62 mm tief
 Streuwert: 1.15, horizontal: 1.31, vertikal: 0.96

10.4 * 10.1 ↗
 10.3 * 10.8 *

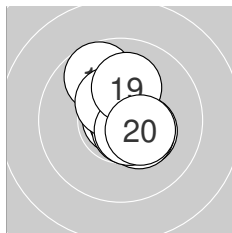

Serie 2:
 9.7 ↘ 10.9 * 10.3 *
 10.7 * 10.4 * 10.6 *
 beste Teiler: 19.7 (14.), 22.8 (12.), 70.2 (16.)
 Trefferlage: 0.30 mm rechts, 0.28 mm hoch
 Streuwert: 1.10, horizontal: 0.88, vertikal: 1.29

10.9 * 10.4 *
 10.1 ↑ 10.4 *

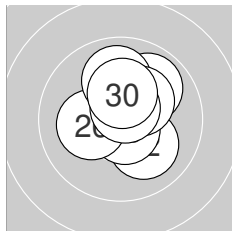

Serie 3:
 10.9 * 10.1 ↘ 10.7 *
 10.2 * 10.0 ↑ 10.3 *
 beste Teiler: 7.0 (21.), 70.7 (23.), 77.6 (29.)
 Trefferlage: 0.28 mm rechts, 0.76 mm hoch
 Streuwert: 1.21, horizontal: 1.03, vertikal: 1.36

10.1 ↑ 9.9 ↗
 10.6 * 10.3 *

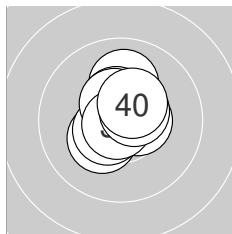

Serie 4:
 10.3 * 10.7 * 10.0 ↑
 10.5 * 10.5 * 10.8 *
 beste Teiler: 35.3 (38.), 59.6 (32.), 104.2 (34.)
 Trefferlage: 0.03 mm rechts, 0.45 mm hoch
 Streuwert: 0.89, horizontal: 0.75, vertikal: 1.01

10.5 * 10.5 *
 10.5 * 10.4 *

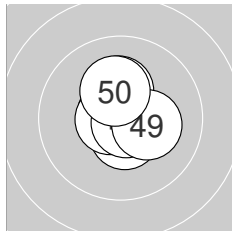

Serie 5:
 10.7 * 10.7 * 10.7 *
 10.7 * 10.3 * 10.8 *
 beste Teiler: 37.2 (44.), 46.2 (48.), 51.0 (41.)
 Trefferlage: 0.19 mm rechts, 0.10 mm hoch
 Streuwert: 0.81, horizontal: 0.67, vertikal: 0.93

10.8 * 10.5 *
 10.3 * 10.2 *

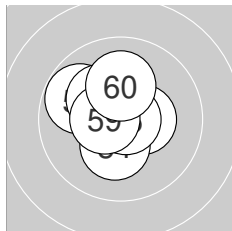

Serie 6:
 10.4 * 10.8 * 10.4 *
 10.4 * 9.8 ↙ 10.2 *
 beste Teiler: 34.0 (52.), 34.1 (55.), 101.0 (59.)
 Trefferlage: 0.62 mm links, 0.46 mm hoch
 Streuwert: 1.06, horizontal: 1.07, vertikal: 1.04

10.3 * 10.8 *
 10.5 * 10.1 ↑



ISSF AR Men – Wertung –
StandNr: 110
Mair, Tobias #184

Männer

StartNr: 52
3. November 2022 11:17
AUT

QF

– Schütze hat sich fürs Finale qualifiziert



Ergebnis: **607.4** (585)
 Serien: 100.0 102.8 102.7 100.3 99.8 101.8
 Zähler: 45 15 0 0 0 0 0 0 0
 Innenzehner: 26
 Weitester: 401 (35.), 390 (19.), 383 (37.)
 beste Teiler: 20.1 (38.), 45.0 (23.), 47.7 (32.)
 Trefferlage: 0.71 mm links, 0.24 mm hoch
 Streuwert: 1.54, horizontal: 1.67, vertikal: 1.40

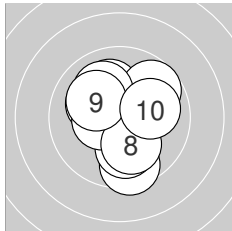
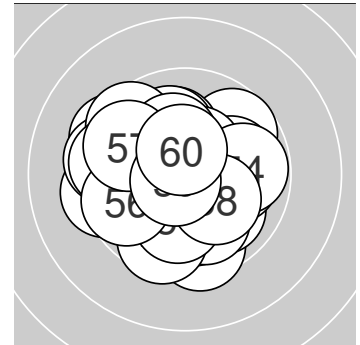

Serie 1:

10.1 ↖	9.5 ↓	9.7 ↗	10.1 ↖	10.0 ↖
10.0 ↓	10.4 *	10.1 ↓	10.1 ↖	10.0 →

beste Teiler: 132.2 (7.), 202.8 (4.), 212.2 (9.)
 Trefferlage: 0.01 mm links, 0.08 mm hoch
 Streuwert: 1.80, horizontal: 1.56, vertikal: 2.01

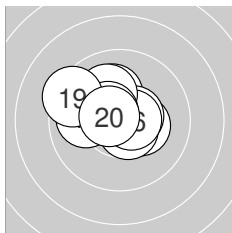

Serie 2:

10.3 *	10.6 *	10.2 *	10.5 *	10.0 ←
10.6 *	10.1 ↖	10.5 *	9.4 ↖	10.6 *

beste Teiler: 82.2 (20.), 87.0 (16.), 91.9 (12.)
 Trefferlage: 0.50 mm links, 0.59 mm hoch
 Streuwert: 1.31, horizontal: 1.60, vertikal: 0.95

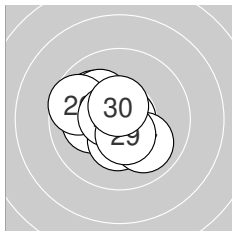

Serie 3:

10.0 ↖	10.1 ↖	10.8 *	10.1 ←	10.3 *
9.7 ↖	10.0 ↖	10.6 *	10.5 *	10.6 *

beste Teiler: 45.0 (23.), 87.3 (28.), 97.5 (30.)
 Trefferlage: 0.68 mm links, 0.03 mm hoch
 Streuwert: 1.32, horizontal: 1.44, vertikal: 1.20

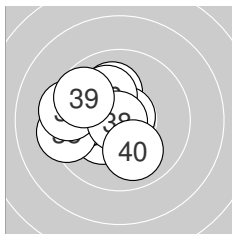

Serie 4:

10.1 ↖	10.8 *	10.3 *	9.7 ←	9.3 ←
10.1 ↖	9.4 ←	10.9 *	9.7 ↖	10.0 ↓

beste Teiler: 20.1 (38.), 47.7 (32.), 163.5 (33.)
 Trefferlage: 1.50 mm links, 0.22 mm hoch
 Streuwert: 1.59, horizontal: 1.76, vertikal: 1.39

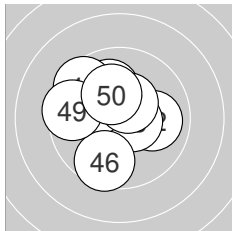

Serie 5:

10.1 ↖	10.0 →	10.6 *	9.7 ↖	10.2 *
9.6 ↓	10.4 *	9.5 ↖	9.5 ←	10.2 *

beste Teiler: 97.2 (43.), 128.0 (47.), 185.9 (50.)
 Trefferlage: 0.93 mm links, 0.66 mm hoch
 Streuwert: 1.74, horizontal: 1.87, vertikal: 1.61

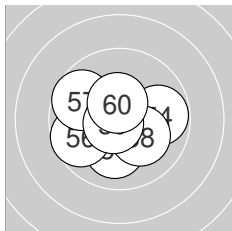

Serie 6:

10.1 ↓	10.4 *	10.2 *	9.8 →	10.5 *
9.7 ↖	9.7 ↖	10.2 *	10.7 *	10.5 *

beste Teiler: 56.8 (59.), 107.5 (55.), 121.0 (60.)
 Trefferlage: 0.62 mm links, 0.12 mm tief
 Streuwert: 1.50, horizontal: 1.78, vertikal: 1.15

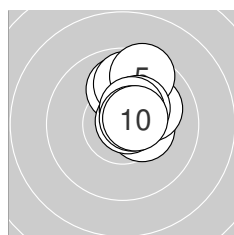
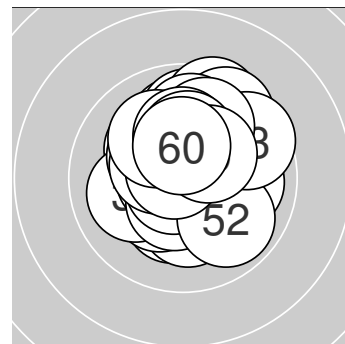

Ergebnis: **620.2** (591)
 Serien: 102.7 104.3 104.9 104.1^{OF} 102.5 101.7
 Zähler: 51 9 0 0 0 0 0 0 0
 Innenzehner: 43
 Weitestе: 358 (5.), 346 (42.), 338 (53.)
 beste Teiler: 17.0 (40.), 41.6 (7.), 42.2 (26.)
 Trefferlage: 0.35 mm rechts, 0.61 mm hoch
 Streuwert: 1.13, horizontal: 1.06, vertikal: 1.20

**Serie 1:**

10.4 *	10.0 ↑	10.1 ↗	9.8 ↑	9.5 ↑
10.3 *	10.8 *	10.5 *	10.7 *	10.6 *

beste Teiler: 41.6 (7.), 75.4 (9.), 96.1 (10.)
 Trefferlage: 0.81 mm rechts, 1.24 mm hoch
 Streuwert: 0.96, horizontal: 0.63, vertikal: 1.20

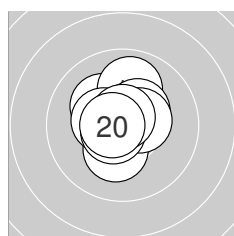
**Serie 2:**

10.2 *	10.6 *	9.9 ↑	10.3 *	10.4 *
10.4 *	10.5 *	10.6 *	10.7 *	10.7 *

beste Teiler: 56.0 (19.), 71.0 (20.), 77.3 (18.)
 Trefferlage: 0.16 mm links, 0.48 mm hoch
 Streuwert: 1.00, horizontal: 0.89, vertikal: 1.09

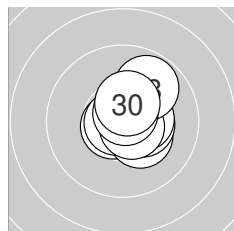
**Serie 3:**

10.7 *	10.7 *	10.3 *	10.4 *	10.4 *
10.8 *	10.7 *	9.8 ↗	10.7 *	10.4 *

beste Teiler: 42.2 (26.), 60.0 (29.), 69.4 (22.)
 Trefferlage: 0.62 mm rechts, 0.18 mm hoch
 Streuwert: 0.87, horizontal: 0.77, vertikal: 0.95

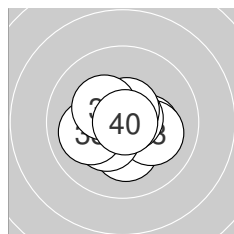
**Serie 4:**

10.3 *	10.2 *	10.1 ↘	10.3 *	10.7 *
10.6 *	10.7 *	10.0 ←	10.3 *	10.9 *

beste Teiler: 17.0 (40.), 61.7 (35.), 72.5 (37.)
 Trefferlage: 0.03 mm links, 0.24 mm tief
 Streuwert: 1.11, horizontal: 1.30, vertikal: 0.88

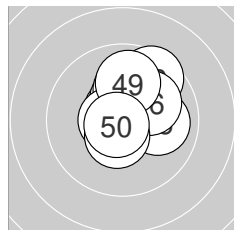
**Serie 5:**

10.6 *	9.6 ↗	10.4 *	10.1 ↑	10.0 →
10.1 ↗	10.6 *	10.5 *	9.9 ↑	10.7 *

beste Teiler: 53.4 (50.), 80.2 (41.), 83.0 (47.)
 Trefferlage: 0.47 mm rechts, 0.92 mm hoch
 Streuwert: 1.25, horizontal: 1.16, vertikal: 1.33

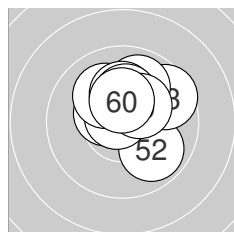
**Serie 6:**

10.4 *	9.9 ↘	9.6 ↗	10.7 *	10.1 ↘
9.9 ↑	10.2 *	10.2 *	10.3 *	10.4 *

beste Teiler: 54.4 (54.), 128.8 (51.), 149.1 (60.)
 Trefferlage: 0.44 mm rechts, 1.13 mm hoch
 Streuwert: 1.27, horizontal: 1.33, vertikal: 1.21



ISSF AR Men – Wertung –
StandNr: 112
Thum, Andreas #169

Männer

StartNr: 54
3. November 2022 11:42
AUT

QF

– Schütze hat sich fürs Finale qualifiziert



Ergebnis: **610.0** (580)
 Serien: 101.9 103.6 98.9 101.9 101.9 101.8
 Zähler: 40 20 0 0 0 0 0 0 0
 Innenzehner: 33
 Weitester: 455 (39.), 441 (24.), 417 (21.)
 beste Teiler: 21.0 (20.), 35.5 (30.), 57.3 (60.)
 Trefferlage: 0.16 mm links, 0.20 mm hoch
 Streuwert: 1.58, horizontal: 1.68, vertikal: 1.48

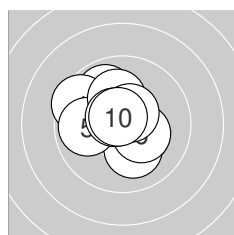
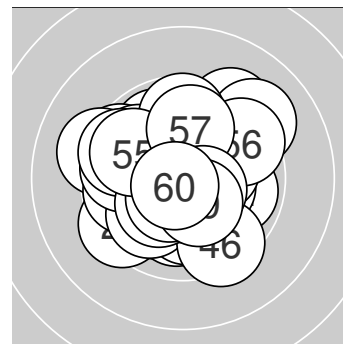

Serie 1:
 10.3 * 10.1 ↘ 9.9 ↗ 9.5 ↖ 9.9 ←
 10.3 * 10.1 ↑ 10.6 * 10.5 * 10.7 *
 beste Teiler: 66.8 (10.), 82.2 (8.), 102.0 (9.)
 Trefferlage: 0.44 mm links, 0.42 mm hoch
 Streuwert: 1.47, horizontal: 1.60, vertikal: 1.33

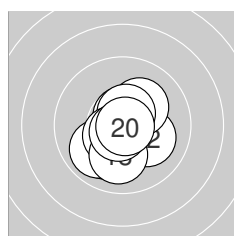

Serie 2:
 10.7 * 10.1 ↘ 10.0 ✓ 10.2 * 10.6 *
 9.9 ✓ 10.5 * 10.0 ↓ 10.7 * 10.9 *
 beste Teiler: 21.0 (20.), 61.0 (19.), 72.0 (11.)
 Trefferlage: 0.10 mm links, 0.53 mm tief
 Streuwert: 1.19, horizontal: 1.11, vertikal: 1.26

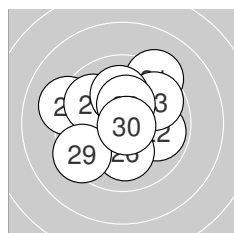

Serie 3:
 9.3 ↗ 9.9 → 9.8 ↗ 9.2 ↖ 9.9 ↖
 10.1 ↓ 10.1 ↑ 10.4 * 9.4 ✓ 10.8 *
 beste Teiler: 35.5 (30.), 146.1 (28.), 218.8 (26.)
 Trefferlage: 0.16 mm links, 0.62 mm hoch
 Streuwert: 2.15, horizontal: 2.38, vertikal: 1.89

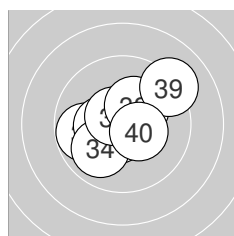

Serie 4:
 9.8 ← 10.3 * 10.6 * 9.9 ✓ 10.6 *
 10.3 * 10.6 * 10.3 * 9.1 ↗ 10.4 *
 beste Teiler: 84.1 (33.), 90.6 (37.), 93.9 (35.)
 Trefferlage: 0.01 mm rechts, 0.29 mm hoch
 Streuwert: 1.62, horizontal: 1.85, vertikal: 1.35

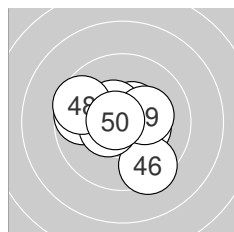

Serie 5:
 10.5 * 9.7 ← 10.5 * 10.5 * 10.3 *
 9.4 ↘ 10.5 * 9.6 ↖ 10.2 * 10.7 *
 beste Teiler: 57.4 (50.), 101.4 (43.), 111.5 (41.)
 Trefferlage: 0.34 mm links, 0.08 mm hoch
 Streuwert: 1.59, horizontal: 1.82, vertikal: 1.32

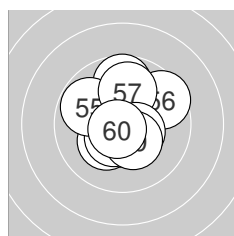

Serie 6:
 10.5 * 10.2 * 9.7 ↑ 10.5 * 9.8 ↖
 9.6 ↗ 9.9 ↑ 10.5 * 10.4 * 10.7 *
 beste Teiler: 57.3 (60.), 106.2 (51.), 117.8 (58.)
 Trefferlage: 0.03 mm rechts, 0.32 mm hoch
 Streuwert: 1.59, horizontal: 1.46, vertikal: 1.70



Ergebnis: **591.8** (563)
 Serien: 97.1 100.7 97.5 99.5 97.6 99.4
 Zähler: 31 21 8 0 0 0 0 0 0
 Innenzehner: 24
 Weitestе: 636 (34.), 616 (28.), 589 (50.)
 beste Teiler: 42.5 (45.), 51.0 (40.), 56.2 (57.)
 Trefferlage: 0.17 mm links, 0.57 mm tief
 Streuwert: 2.17, horizontal: 2.45, vertikal: 1.86

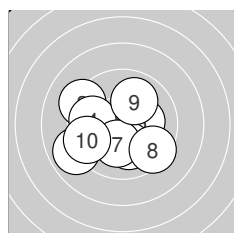
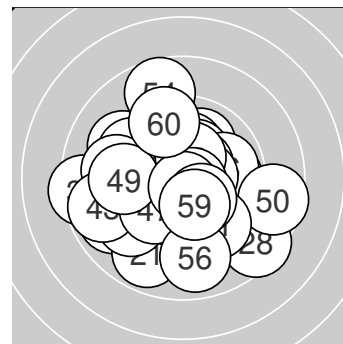

Serie 1:
 8.9 ← 9.7 ← 9.2 ↖ 9.8 ← 10.2 *
 10.1 ↓ 10.2 * 9.5 ↘ 10.0 ↗ 9.5 ←
 beste Teiler: 181.7 (5.), 192.1 (7.), 216.2 (6.)
 Trefferlage: 1.17 mm links, 0.65 mm tief
 Streuwert: 2.25, horizontal: 2.64, vertikal: 1.78

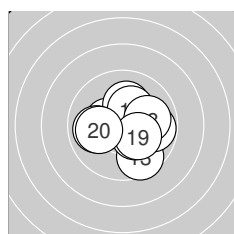

Serie 2:
 10.4 * 10.2 * 9.6 ↓ 10.3 * 10.3 *
 9.9 ← 9.8 → 10.0 → 10.2 * 10.0 ←
 beste Teiler: 144.0 (11.), 156.4 (14.), 169.5 (15.)
 Trefferlage: 0.44 mm rechts, 0.18 mm tief
 Streuwert: 1.66, horizontal: 1.89, vertikal: 1.40

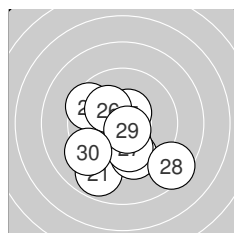

Serie 3:
 8.9 ↓ 10.5 * 9.6 ↓ 9.5 ↖ 10.5 *
 10.2 * 10.0 ↓ 8.5 ↘ 10.6 * 9.2 ←
 beste Teiler: 76.6 (29.), 111.4 (22.), 112.7 (25.)
 Trefferlage: 0.24 mm links, 1.46 mm tief
 Streuwert: 2.33, horizontal: 2.39, vertikal: 2.27

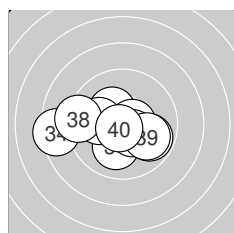

Serie 4:
 10.1 ↓ 9.8 ↘ 10.3 * 8.4 ← 10.6 *
 10.4 * 10.1 ← 9.2 ← 9.9 ↘ 10.7 *
 beste Teiler: 51.0 (40.), 91.7 (35.), 128.8 (36.)
 Trefferlage: 0.80 mm links, 0.43 mm tief
 Streuwert: 2.11, horizontal: 2.82, vertikal: 1.00

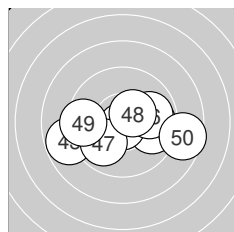

Serie 5:
 10.2 * 9.8 → 8.8 ← 9.8 → 10.8 *
 9.9 → 9.9 ↗ 10.4 * 9.4 ← 8.6 →
 beste Teiler: 42.5 (45.), 127.5 (48.), 198.8 (41.)
 Trefferlage: 0.25 mm rechts, 0.60 mm tief
 Streuwert: 2.47, horizontal: 3.36, vertikal: 0.98

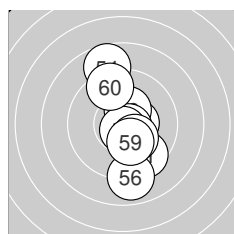

Serie 6:
 9.5 ↘ 10.5 * 10.4 * 8.7 ↑ 10.7 *
 8.9 ↓ 10.7 * 10.3 * 10.2 * 9.5 ↑
 beste Teiler: 56.2 (57.), 64.0 (55.), 125.4 (52.)
 Trefferlage: 0.44 mm rechts, 0.13 mm tief
 Streuwert: 2.27, horizontal: 1.09, vertikal: 3.02

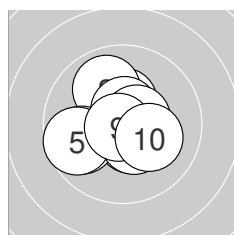
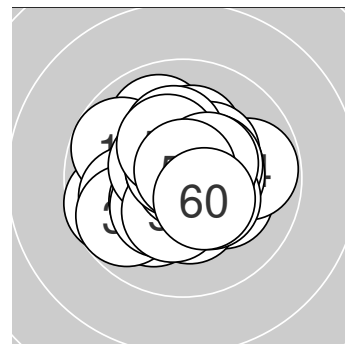

Ergebnis: **624.9** (594)
 Serien: 102.9 102.8 104.7 103.5^{OF} 105.3 105.7
 Zähler: 54 6 0 0 0 0 0 0 0
 Innenzehner: 51
 Weitest: 320 (5.), 299 (16.), 297 (38.)
 beste Teiler: 12.1 (54.), 34.4 (9.), 37.1 (59.)
 Trefferlage: 0.11 mm links, 0.02 mm tief
 Streuwert: 1.09, horizontal: 1.20, vertikal: 0.96

**Serie 1:**

10.4 *	9.9 ↘	10.5 *	9.8 ←	9.7 ←
10.6 *	10.4 *	10.6 *	10.8 *	10.2 *

beste Teiler: 34.4 (9.), 91.9 (6.), 99.3 (8.)
 Trefferlage: 0.29 mm links, 0.02 mm tief
 Streuwert: 1.40, horizontal: 1.54, vertikal: 1.24

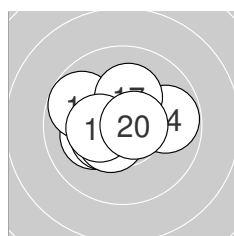
**Serie 2:**

10.1 ←	10.2 *	10.8 *	9.8 →	10.4 *
9.8 ↖	10.2 *	10.5 *	10.3 *	10.7 *

beste Teiler: 38.9 (13.), 75.0 (20.), 117.5 (18.)
 Trefferlage: 0.63 mm links, 0.18 mm hoch
 Streuwert: 1.31, horizontal: 1.62, vertikal: 0.89

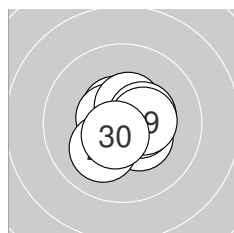
**Serie 3:**

10.6 *	10.4 *	10.6 *	10.6 *	10.5 *
10.5 *	10.1 ↙	10.4 *	10.4 *	10.6 *

beste Teiler: 76.5 (21.), 92.1 (30.), 92.3 (24.)
 Trefferlage: 0.27 mm rechts, 0.00 mm
 Streuwert: 0.92, horizontal: 0.98, vertikal: 0.87

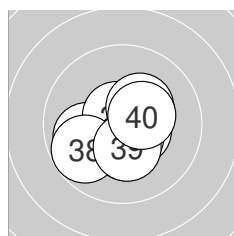
**Serie 4:**

10.5 *	10.6 *	10.0 ←	10.6 *	10.7 *
10.3 *	10.3 *	9.8 ↙	10.3 *	10.4 *

beste Teiler: 70.2 (35.), 92.6 (32.), 96.3 (34.)
 Trefferlage: 0.01 mm links, 0.38 mm tief
 Streuwert: 1.21, horizontal: 1.36, vertikal: 1.04

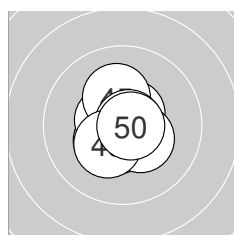
**Serie 5:**

10.4 *	10.6 *	10.6 *	10.8 *	10.2 *
10.5 *	10.4 *	10.8 *	10.3 *	10.7 *

beste Teiler: 41.2 (48.), 45.0 (44.), 54.3 (50.)
 Trefferlage: 0.05 mm links, 0.12 mm tief
 Streuwert: 0.88, horizontal: 0.78, vertikal: 0.96

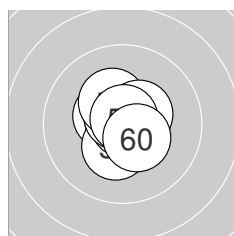
**Serie 6:**

10.5 *	10.8 *	10.3 *	10.9 *	10.7 *
10.6 *	10.3 *	10.4 *	10.8 *	10.4 *

beste Teiler: 12.1 (54.), 37.1 (59.), 48.6 (52.)
 Trefferlage: 0.03 mm rechts, 0.17 mm hoch
 Streuwert: 0.78, horizontal: 0.74, vertikal: 0.82



ISSF AR Men – Wertung –

Männer

StartNr: 57

StandNr: 115

3. November 2022 11:41

Höllwarth, Michael #173

AUT

QF

– Schütze hat sich fürs Finale qualifiziert



Ergebnis: **617.5** (593)
 Serien: 102.0 104.0 104.2 104.8 103.4 99.1
 Zähler: 56 3 0 0 1 0 0 0 0
 Innenzehner: 50
 Weitester: 1188 (53.), 405 (9.), 312 (3.)
 beste Teiler: 29.0 (54.), 34.9 (50.), 45.6 (1.)
 Trefferlage: 0.37 mm rechts, 0.10 mm hoch
 Streuwert: 1.55, horizontal: 1.13, vertikal: 1.87

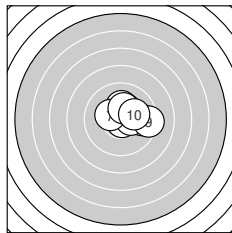
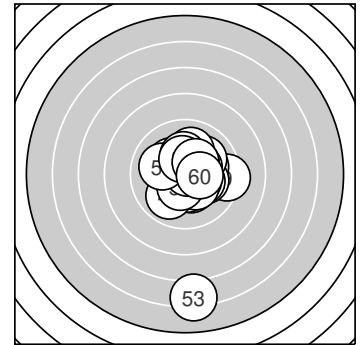

Serie 1:
 10.8 * 10.3 * 9.7 → 10.6 * 10.2 *
 10.4 * 10.3 * 10.3 * 9.3 → 10.1 →
 beste Teiler: 45.6 (1.), 99.1 (4.), 148.1 (6.)
 Trefferlage: 1.06 mm rechts, 0.63 mm hoch
 Streuwert: 1.29, horizontal: 1.62, vertikal: 0.84

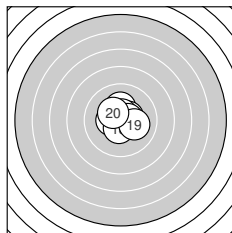

Serie 2:
 10.2 * 10.5 * 10.6 * 10.3 * 10.6 *
 10.5 * 10.4 * 10.5 * 10.1 ↘ 10.3 *
 beste Teiler: 80.6 (15.), 84.5 (13.), 102.4 (16.)
 Trefferlage: 0.36 mm rechts, 0.18 mm hoch
 Streuwert: 0.98, horizontal: 1.07, vertikal: 0.88

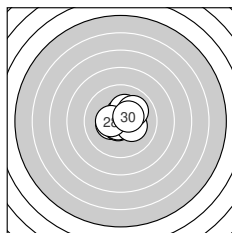

Serie 3:
 10.4 * 10.7 * 10.5 * 10.5 * 10.3 *
 10.7 * 10.3 * 10.4 * 10.0 ↗ 10.4 *
 beste Teiler: 58.2 (26.), 68.2 (22.), 102.2 (24.)
 Trefferlage: 0.27 mm rechts, 0.27 mm hoch
 Streuwert: 1.01, horizontal: 1.14, vertikal: 0.86

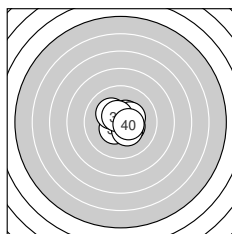

Serie 4:
 10.5 * 10.4 * 10.7 * 10.6 * 10.5 *
 10.4 * 10.2 * 10.4 * 10.6 * 10.5 *
 beste Teiler: 72.0 (33.), 89.0 (34.), 99.8 (39.)
 Trefferlage: 0.31 mm rechts, 0.09 mm hoch
 Streuwert: 0.92, horizontal: 0.98, vertikal: 0.87

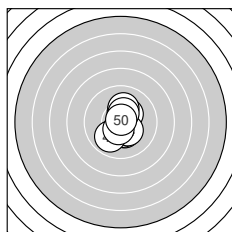

Serie 5:
 10.3 * 10.3 * 10.4 * 10.3 * 9.9 ↙
 10.5 * 10.4 * 10.1 ↑ 10.4 * 10.8 *
 beste Teiler: 34.9 (50.), 105.6 (46.), 133.4 (49.)
 Trefferlage: 0.22 mm rechts, 0.09 mm tief
 Streuwert: 1.17, horizontal: 0.73, vertikal: 1.49

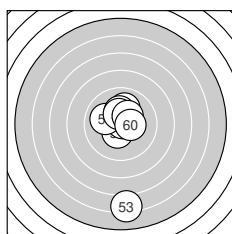

Serie 6:
 10.4 * 10.4 * 6.2 ↓ 10.8 * 10.0 ↑
 10.0 ↖ 10.2 * 10.4 * 10.3 * 10.4 *
 beste Teiler: 29.0 (54.), 128.2 (51.), 130.9 (52.)
 Trefferlage: 0.03 mm rechts, 0.46 mm tief
 Streuwert: 3.01, horizontal: 1.04, vertikal: 4.13



Ergebnis: **602.4** (574)
 Serien: 102.0 97.5 98.8 101.2 100.5 102.4
 Zähler: 38 19 2 1 0 0 0 0 0
 Innenzehner: 30
 Weitestе: 770 (23.), 595 (17.), 540 (31.)
 beste Teiler: 15.0 (35.), 22.4 (57.), 40.2 (8.)
 Trefferlage: 0.21 mm links, 0.23 mm tief
 Streuwert: 1.90, horizontal: 2.08, vertikal: 1.70

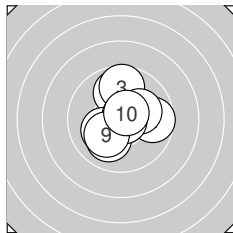
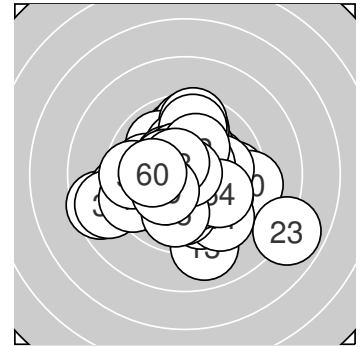

Serie 1:
 9.9 ↑ 9.7 → 9.7 ↑ 10.2 * 10.2 *
 10.0 ↘ 10.8 * 10.8 * 10.1 ↘ 10.6 *
 beste Teiler: 40.2 (8.), 50.6 (7.), 84.2 (10.)
 Trefferlage: 0.17 mm rechts, 0.27 mm hoch
 Streuwert: 1.58, horizontal: 1.49, vertikal: 1.66

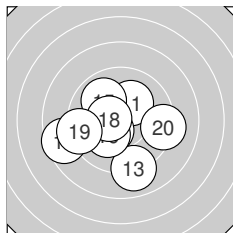

Serie 2:
 10.2 * 10.2 * 9.0 ↓ 10.4 * 9.9 ↘
 10.2 * 8.6 ← 10.5 * 9.3 ← 9.2 →
 beste Teiler: 114.9 (18.), 137.2 (14.), 193.3 (16.)
 Trefferlage: 1.00 mm links, 0.77 mm tief
 Streuwert: 2.37, horizontal: 2.76, vertikal: 1.90

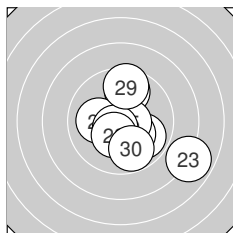

Serie 3:
 9.9 ↘ 10.2 * 7.9 ↘ 9.8 ↑ 10.6 *
 10.1 ← 10.6 * 10.3 * 9.6 ↑ 9.8 ↓
 beste Teiler: 82.6 (25.), 84.5 (27.), 152.0 (28.)
 Trefferlage: 0.98 mm rechts, 0.49 mm tief
 Streuwert: 2.30, horizontal: 2.36, vertikal: 2.25

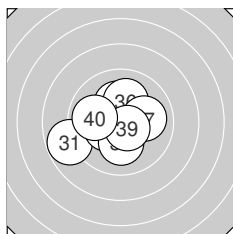

Serie 4:
 8.8 ← 10.3 * 10.2 * 10.3 * 10.9 *
 10.1 ↑ 10.0 → 10.1 ↓ 10.6 * 9.9 ←
 beste Teiler: 15.0 (35.), 88.5 (39.), 152.6 (32.)
 Trefferlage: 0.43 mm links, 0.00 mm
 Streuwert: 1.79, horizontal: 2.12, vertikal: 1.37

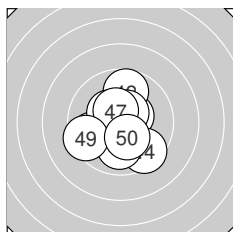

Serie 5:
 10.5 * 9.7 ↑ 10.5 * 9.5 ↘ 9.7 ←
 10.4 * 10.5 * 10.0 ↓ 9.4 ← 10.3 *
 beste Teiler: 108.5 (43.), 122.2 (41.), 123.6 (47.)
 Trefferlage: 0.28 mm links, 0.29 mm tief
 Streuwert: 1.82, horizontal: 1.76, vertikal: 1.88

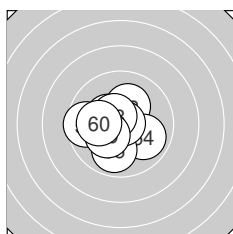

Serie 6:
 9.6 ← 10.2 * 10.5 * 9.9 ↘ 9.9 ↓
 10.4 * 10.9 * 10.6 * 10.3 * 10.1 ←
 beste Teiler: 22.4 (57.), 99.4 (58.), 118.1 (53.)
 Trefferlage: 0.74 mm links, 0.15 mm tief
 Streuwert: 1.40, horizontal: 1.56, vertikal: 1.21



Ergebnis: **625.7** (597)
 Serien: 104.5 104.2 105.3 104.8^{OF} 102.7 104.2
 Zähler: 57 3 0 0 0 0 0 0 0
 Innenzehner: 51
 Weitest: 419 (44.), 287 (6.), 266 (58.)
 beste Teiler: 32.1 (26.), 37.6 (32.), 53.0 (12.)
 Trefferlage: 0.04 mm links, 0.20 mm hoch
 Streuwert: 1.05, horizontal: 1.07, vertikal: 1.02

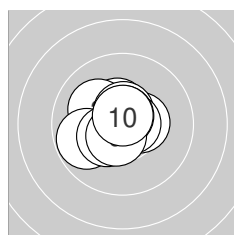
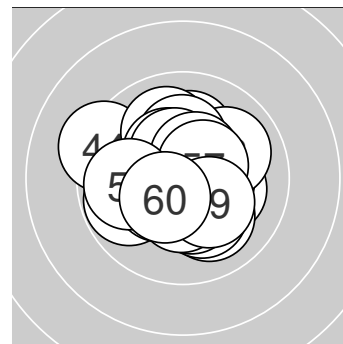

Serie 1:

10.5 *	10.4 *	10.1 ↘	10.6 *	10.7 *
9.8 ↙	10.7 *	10.4 *	10.6 *	10.7 *

beste Teiler: 59.2 (5.), 62.2 (7.), 64.0 (10.)
 Trefferlage: 0.45 mm links, 0.17 mm hoch
 Streuwert: 1.02, horizontal: 1.15, vertikal: 0.85

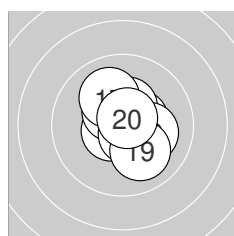

Serie 2:

10.5 *	10.7 *	10.6 *	10.4 *	10.4 *
10.2 *	10.1 ↘	10.6 *	10.0 ↘	10.7 *

beste Teiler: 53.0 (12.), 62.1 (20.), 79.3 (18.)
 Trefferlage: 0.23 mm rechts, 0.17 mm hoch
 Streuwert: 1.06, horizontal: 1.00, vertikal: 1.13

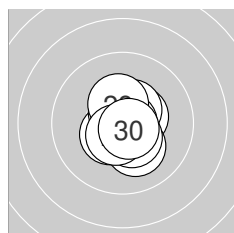

Serie 3:

10.5 *	10.2 *	10.5 *	10.5 *	10.6 *
10.8 *	10.5 *	10.4 *	10.6 *	10.7 *

beste Teiler: 32.1 (26.), 61.5 (30.), 82.2 (25.)
 Trefferlage: 0.21 mm rechts, 0.11 mm tief
 Streuwert: 0.87, horizontal: 0.69, vertikal: 1.02

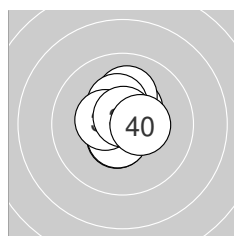

Serie 4:

10.7 *	10.8 *	10.5 *	10.4 *	10.1 ↑
10.3 *	10.5 *	10.4 *	10.7 *	10.4 *

beste Teiler: 37.6 (32.), 55.3 (39.), 64.3 (31.)
 Trefferlage: 0.07 mm links, 0.34 mm hoch
 Streuwert: 0.88, horizontal: 0.73, vertikal: 1.01

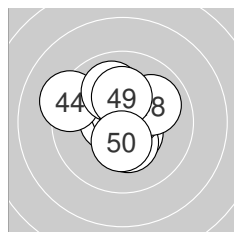

Serie 5:

10.6 *	10.5 *	10.7 *	9.3 ↘	10.3 *
10.0 ↘	10.7 *	10.0 ↗	10.2 *	10.4 *

beste Teiler: 69.4 (47.), 71.8 (43.), 95.5 (41.)
 Trefferlage: 0.21 mm links, 0.44 mm hoch
 Streuwert: 1.45, horizontal: 1.56, vertikal: 1.34

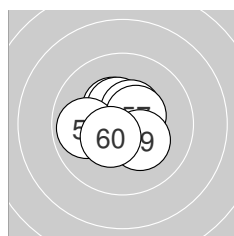

Serie 6:

10.4 *	10.5 *	10.7 *	10.4 *	10.6 *
10.5 *	10.5 *	9.9 ↙	10.3 *	10.4 *

beste Teiler: 57.8 (53.), 78.7 (55.), 103.4 (52.)
 Trefferlage: 0.00 mm, 0.20 mm hoch
 Streuwert: 1.05, horizontal: 1.19, vertikal: 0.90



ISSF AR Men – Wertung –

Männer

StartNr: 60

StandNr: 118

3. November 2022 11:22

Rossiter,, Jack #70507140

Australia

QF

– Schütze hat sich fürs Finale qualifiziert



Ergebnis: **626.5** (597)
 Serien: 106.2 103.7 104.1 104.5^{OF} 103.5 104.5
 Zähler: 57 3 0 0 0 0 0 0 0
 Innenzehner: 49
 Weitester: 352 (16.), 290 (56.), 263 (30.)
 beste Teiler: 2.2 (15.), 20.0 (8.), 27.8 (25.)
 Trefferlage: 0.08 mm links, 0.04 mm tief
 Streuwert: 1.03, horizontal: 0.83, vertikal: 1.20

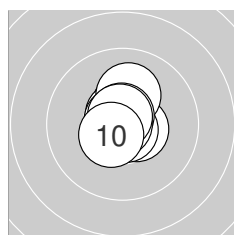
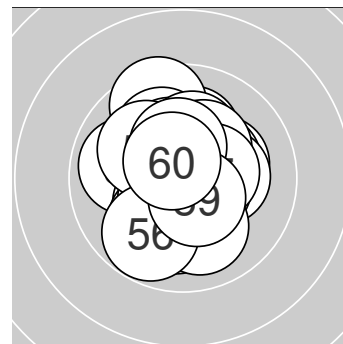

Serie 1:

10.4 *	10.6 *	10.7 *	10.8 *	10.1 ↑
10.8 *	10.7 *	10.9 *	10.7 *	10.5 *

beste Teiler: 20.0 (8.), 44.2 (4.), 50.8 (6.)
 Trefferlage: 0.03 mm links, 0.39 mm hoch
 Streuwert: 0.68, horizontal: 0.48, vertikal: 0.83

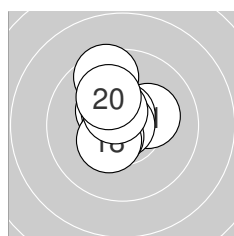

Serie 2:

10.2 *	10.7 *	10.4 *	10.5 *	10.9 *
9.5 ↘	10.5 *	10.4 *	10.5 *	10.1 ↘

beste Teiler: 2.2 (15.), 70.0 (12.), 107.8 (14.)
 Trefferlage: 0.42 mm links, 0.76 mm hoch
 Streuwert: 1.08, horizontal: 0.86, vertikal: 1.26

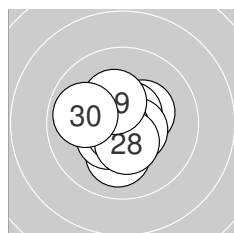

Serie 3:

10.1 ↓	10.3 *	10.6 *	10.4 *	10.8 *
10.6 *	10.7 *	10.4 *	10.3 *	9.9 ←

beste Teiler: 27.8 (25.), 55.6 (27.), 79.8 (23.)
 Trefferlage: 0.20 mm links, 0.19 mm tief
 Streuwert: 1.09, horizontal: 1.09, vertikal: 1.09

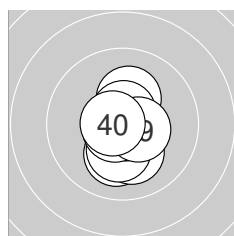

Serie 4:

10.2 *	10.1 ↓	10.1 ↓	10.6 *	10.2 *
10.8 *	10.6 *	10.7 *	10.5 *	10.7 *

beste Teiler: 34.5 (36.), 64.4 (38.), 69.1 (40.)
 Trefferlage: 0.02 mm rechts, 0.43 mm tief
 Streuwert: 0.96, horizontal: 0.56, vertikal: 1.23

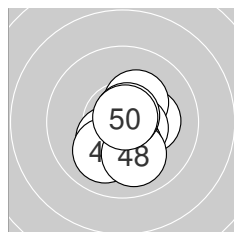

Serie 5:

10.3 *	10.2 *	10.3 *	10.6 *	10.4 *
10.2 *	10.0 ↘	10.0 ↓	10.7 *	10.8 *

beste Teiler: 36.7 (50.), 56.3 (49.), 99.8 (44.)
 Trefferlage: 0.35 mm rechts, 0.65 mm tief
 Streuwert: 1.06, horizontal: 0.89, vertikal: 1.20

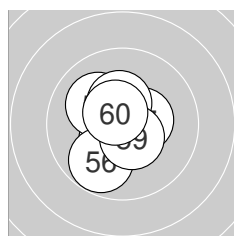

Serie 6:

10.5 *	10.8 *	10.7 *	10.7 *	10.1 ↘
9.8 ↘	10.4 *	10.4 *	10.5 *	10.6 *

beste Teiler: 32.5 (52.), 52.3 (54.), 72.8 (53.)
 Trefferlage: 0.25 mm links, 0.13 mm tief
 Streuwert: 1.07, horizontal: 0.91, vertikal: 1.21



ISSF AR Men – Wertung –
StandNr: 119
Diem, Patrick #165

Männer

StartNr: 61
3. November 2022 11:31
AUT

QF

– Schütze hat sich fürs Finale qualifiziert



Ergebnis: **614.9** (588)
 Serien: 101.1 104.1 102.6 103.3 101.3 102.5
 Zähler: 48 12 0 0 0 0 0 0 0
 Innenzehner: 39
 Weitestе: 409 (46.), 392 (38.), 387 (3.)
 beste Teiler: 33.0 (36.), 41.9 (56.), 45.8 (31.)
 Trefferlage: 0.61 mm links, 0.23 mm hoch
 Streuwert: 1.32, horizontal: 1.43, vertikal: 1.20

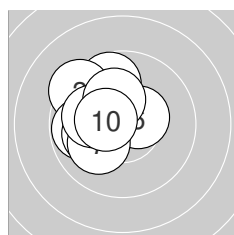
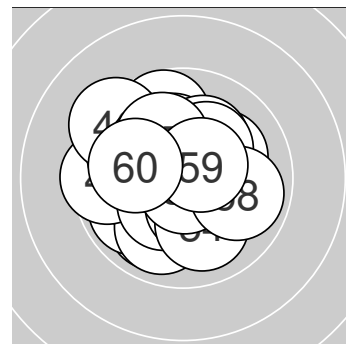

Serie 1:
 9.7 ↗ 10.7 * 9.4 ↘ 9.8 ← 10.1 ←
 10.5 * 10.1 ↙ 10.1 ← 10.2 * 10.5 *
 beste Teiler: 52.2 (2.), 121.7 (6.), 124.1 (10.)
 Trefferlage: 1.33 mm links, 0.66 mm hoch
 Streuwert: 1.32, horizontal: 1.30, vertikal: 1.34

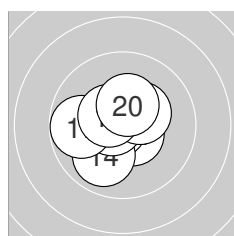

Serie 2:
 10.6 * 10.6 * 10.7 * 9.9 ↙ 10.6 *
 10.7 * 9.8 ← 10.3 * 10.5 * 10.4 *
 beste Teiler: 51.1 (13.), 74.2 (16.), 77.4 (11.)
 Trefferlage: 0.33 mm links, 0.07 mm hoch
 Streuwert: 1.13, horizontal: 1.24, vertikal: 1.00

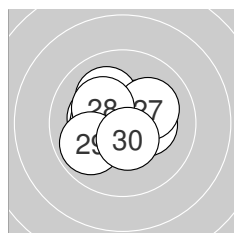

Serie 3:
 10.4 * 10.3 * 10.6 * 10.2 * 10.1 ↘
 10.3 * 10.1 ↗ 10.2 * 9.9 ↙ 10.5 *
 beste Teiler: 93.1 (23.), 117.6 (30.), 133.0 (21.)
 Trefferlage: 0.41 mm links, 0.24 mm hoch
 Streuwert: 1.27, horizontal: 1.50, vertikal: 1.00

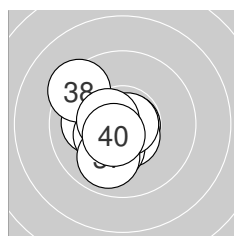

Serie 4:
 10.8 * 10.1 ← 10.4 * 10.6 * 10.2 *
 10.8 * 9.9 ↙ 9.4 ↘ 10.5 * 10.6 *
 beste Teiler: 33.0 (36.), 45.8 (31.), 94.3 (34.)
 Trefferlage: 0.87 mm links, 0.38 mm tief
 Streuwert: 1.22, horizontal: 1.15, vertikal: 1.28

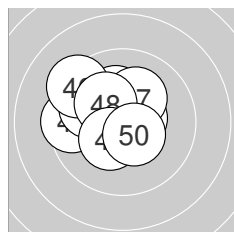

Serie 5:
 10.5 * 10.2 * 9.5 ← 9.9 ↘ 10.6 *
 9.3 ↘ 10.2 * 10.2 * 10.4 * 10.5 *
 beste Teiler: 100.0 (45.), 103.3 (41.), 121.0 (50.)
 Trefferlage: 1.00 mm links, 0.67 mm hoch
 Streuwert: 1.45, horizontal: 1.66, vertikal: 1.21

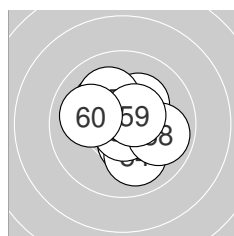

Serie 6:
 10.2 * 10.4 * 10.4 * 10.0 ↘ 10.2 *
 10.8 * 10.1 ↘ 9.9 → 10.5 * 10.0 ←
 beste Teiler: 41.9 (56.), 105.8 (59.), 127.1 (52.)
 Trefferlage: 0.26 mm rechts, 0.12 mm hoch
 Streuwert: 1.36, horizontal: 1.43, vertikal: 1.29



Ergebnis: **589.0** (563)
 Serien: 98.1 100.6 97.6 98.5 96.9 97.3
 Zähler: 28 27 5 0 0 0 0 0 0
 Innenzehner: 16
 Weitester: 746 (56.), 554 (8.), 547 (50.)
 beste Teiler: 62.3 (45.), 75.2 (57.), 78.5 (19.)
 Trefferlage: 0.36 mm rechts, 0.11 mm tief
 Streuwert: 2.25, horizontal: 2.49, vertikal: 1.98

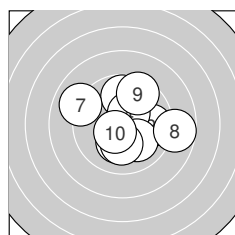
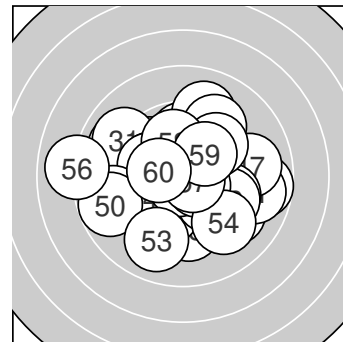

Serie 1:
 9.8 ↑ 9.8 → 10.2 * 10.4 * 10.1 ↘
 10.1 ↓ 9.0 ↖ 8.7 → 9.5 ↗ 10.5 *
 beste Teiler: 113.8 (10.), 133.3 (4.), 195.4 (3.)
 Trefferlage: 0.62 mm rechts, 0.21 mm hoch
 Streuwert: 2.32, horizontal: 2.60, vertikal: 2.00

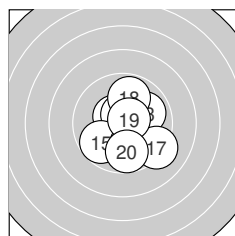

Serie 2:
 10.5 * 10.4 * 9.9 ↗ 10.6 * 9.7 ↘
 10.0 ↘ 9.2 ↘ 9.9 ↑ 10.6 * 9.8 ↓
 beste Teiler: 78.5 (19.), 91.1 (14.), 113.8 (11.)
 Trefferlage: 0.63 mm rechts, 0.31 mm tief
 Streuwert: 1.78, horizontal: 1.60, vertikal: 1.94

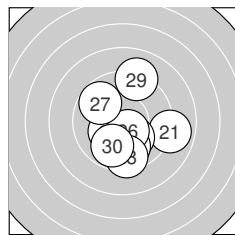

Serie 3:
 8.9 → 10.1 ↘ 9.8 ↓ 9.9 ↓ 10.3 *
 10.5 * 9.7 ↖ 9.5 ↓ 9.1 ↑ 9.8 ↘
 beste Teiler: 116.7 (26.), 175.4 (25.), 204.7 (22.)
 Trefferlage: 0.50 mm rechts, 1.02 mm tief
 Streuwert: 2.23, horizontal: 1.99, vertikal: 2.44

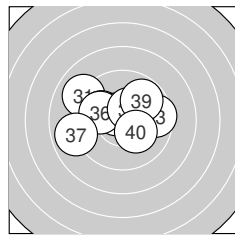

Serie 4:
 9.0 ↖ 10.0 → 9.6 → 10.0 ↖ 10.6 *
 10.0 ↖ 8.9 ← 10.4 * 9.8 ↗ 10.2 *
 beste Teiler: 92.0 (35.), 134.2 (38.), 184.2 (40.)
 Trefferlage: 0.45 mm links, 0.68 mm hoch
 Streuwert: 2.20, horizontal: 2.85, vertikal: 1.26

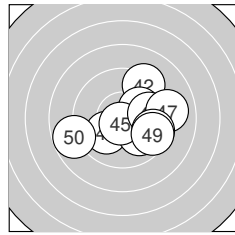

Serie 5:
 10.0 ↗ 9.3 ↗ 10.1 → 10.0 ↘ 10.7 *
 9.8 → 9.1 → 9.6 → 9.5 → 8.8 ←
 beste Teiler: 62.3 (45.), 205.1 (43.), 227.9 (41.)
 Trefferlage: 1.25 mm rechts, 0.30 mm tief
 Streuwert: 2.37, horizontal: 2.87, vertikal: 1.73

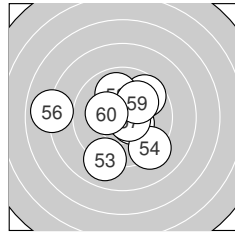

Serie 6:
 10.4 * 9.7 ↗ 9.0 ↓ 9.2 ↘ 10.0 ↑
 8.0 ← 10.7 * 9.9 ↑ 10.1 ↗ 10.3 *
 beste Teiler: 75.2 (57.), 126.9 (51.), 173.6 (60.)
 Trefferlage: 0.37 mm links, 0.07 mm hoch
 Streuwert: 2.67, horizontal: 2.96, vertikal: 2.34



Ergebnis: **620.7** (587)
 Serien: 105.3 102.5 103.6 102.9^{OF} 103.7 102.7
 Zähler: 47 13 0 0 0 0 0 0 0
 Innenzehner: 41
 Weitester: 376 (34.), 313 (52.), 301 (38.)
 beste Teiler: 9.0 (33.), 10.0 (57.), 11.6 (6.)
 Trefferlage: 0.13 mm rechts, 0.01 mm hoch
 Streuwert: 1.26, horizontal: 1.47, vertikal: 1.01

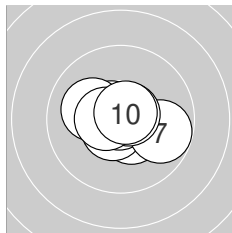
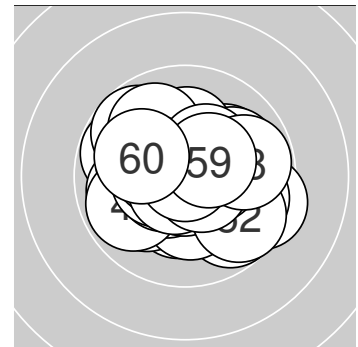

Serie 1:

10.5 *	10.9 *	10.6 *	10.1 ↖	10.6 *
10.9 *	9.8 ↗	10.7 *	10.5 *	10.7 *

beste Teiler: 11.6 (6.), 19.6 (2.), 58.6 (10.)
 Trefferlage: 0.03 mm rechts, 0.03 mm tief
 Streuwert: 1.00, horizontal: 1.28, vertikal: 0.59

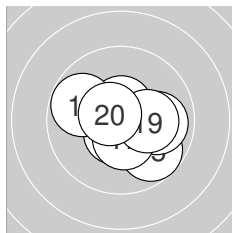

Serie 2:

10.7 *	10.6 *	10.6 *	9.9 ↘	9.8 ↘
9.9 →	10.4 *	9.8 ↖	10.2 *	10.6 *

beste Teiler: 52.2 (11.), 87.8 (20.), 91.1 (12.)
 Trefferlage: 0.51 mm rechts, 0.32 mm tief
 Streuwert: 1.40, horizontal: 1.64, vertikal: 1.10

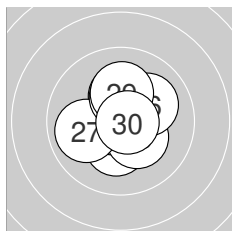

Serie 3:

10.3 *	10.8 *	10.7 *	10.2 *	10.3 *
10.1 ↗	9.9 ↖	10.3 *	10.2 *	10.8 *

beste Teiler: 48.5 (22.), 49.8 (30.), 60.6 (23.)
 Trefferlage: 0.00 mm, 0.33 mm hoch
 Streuwert: 1.21, horizontal: 1.13, vertikal: 1.28

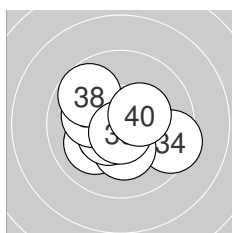

Serie 4:

10.9 *	10.1 ↖	10.9 *	9.4 ↗	10.3 *
10.5 *	10.1 ↖	9.7 ↘	10.7 *	10.3 *

beste Teiler: 9.0 (33.), 22.8 (31.), 59.0 (39.)
 Trefferlage: 0.15 mm links, 0.20 mm tief
 Streuwert: 1.47, horizontal: 1.74, vertikal: 1.14

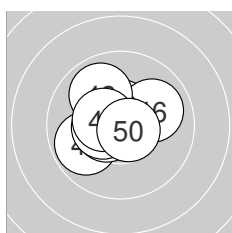

Serie 5:

9.8 ↖	10.5 *	10.6 *	10.7 *	10.4 *
10.0 ↗	10.6 *	9.9 ↘	10.5 *	10.7 *

beste Teiler: 66.0 (50.), 66.3 (44.), 86.9 (47.)
 Trefferlage: 0.53 mm links, 0.34 mm hoch
 Streuwert: 1.14, horizontal: 1.29, vertikal: 0.96

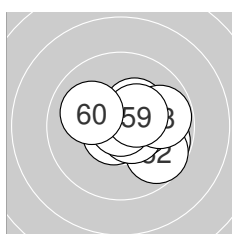

Serie 6:

9.8 ↗	9.7 ↘	10.3 *	10.7 *	10.4 *
10.6 *	10.9 *	9.8 →	10.4 *	10.1 ↖

beste Teiler: 10.0 (57.), 70.0 (54.), 89.0 (56.)
 Trefferlage: 0.97 mm rechts, 0.01 mm tief
 Streuwert: 1.27, horizontal: 1.53, vertikal: 0.95



ISSF AR Men – Wertung –
StandNr: 123
Pixner, Herbert #70507061

Männer

StartNr: 65
3. November 2022 11:23
St. Leonhard in Passeier

QF

– Schütze hat sich fürs Finale qualifiziert



Ergebnis: **616.1** (585)
 Serien: 101.8 103.8 101.9 103.3 100.7 104.6
 Zähler: 45 15 0 0 0 0 0 0 0
 Innenzehner: 37
 Weitest: 383 (24.), 362 (31.), 330 (47.)
 beste Teiler: 10.8 (27.), 16.1 (15.), 20.5 (55.)
 Trefferlage: 0.02 mm rechts, 0.48 mm hoch
 Streuwert: 1.36, horizontal: 1.70, vertikal: 0.92

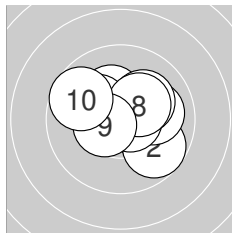
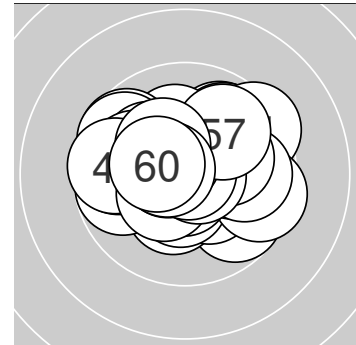

Serie 1:
 10.3 * 9.7 ↘ 10.3 * 10.2 * 10.0 →
 10.7 * 10.1 ↗ 10.3 * 10.5 * 9.7 ↖
 beste Teiler: 68.2 (6.), 118.9 (9.), 165.2 (8.)
 Trefferlage: 0.35 mm rechts, 0.36 mm hoch
 Streuwert: 1.49, horizontal: 1.79, vertikal: 1.11

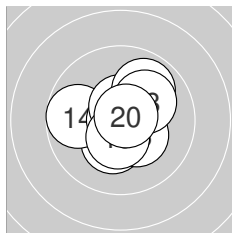

Serie 2:
 10.3 * 10.7 * 10.3 * 9.7 ← 10.9 *
 10.6 * 9.9 ↗ 10.1 ↗ 10.5 * 10.8 *
 beste Teiler: 16.1 (15.), 48.4 (20.), 64.6 (12.)
 Trefferlage: 0.13 mm rechts, 0.07 mm hoch
 Streuwert: 1.26, horizontal: 1.35, vertikal: 1.17

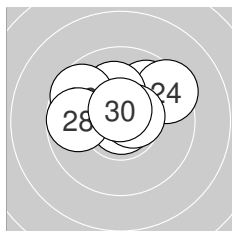

Serie 3:
 10.4 * 9.9 ↗ 10.5 * 9.4 ↗ 10.1 ↑
 9.7 ↖ 10.9 * 9.8 ← 10.6 * 10.6 *
 beste Teiler: 10.8 (27.), 80.0 (30.), 94.7 (29.)
 Trefferlage: 0.11 mm links, 1.09 mm hoch
 Streuwert: 1.46, horizontal: 1.88, vertikal: 0.85

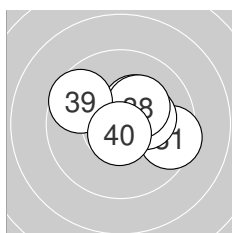

Serie 4:
 9.5 → 10.8 * 10.4 * 10.7 * 10.6 *
 10.3 * 10.3 * 10.3 * 9.7 ↖ 10.7 *
 beste Teiler: 32.7 (32.), 56.0 (34.), 67.4 (40.)
 Trefferlage: 0.70 mm rechts, 0.42 mm hoch
 Streuwert: 1.26, horizontal: 1.58, vertikal: 0.83

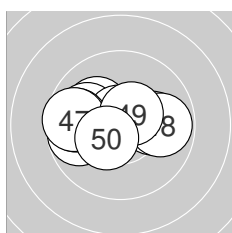

Serie 5:
 9.8 ← 10.1 ↖ 10.0 ← 10.1 → 10.7 *
 9.7 ← 9.6 ← 9.8 → 10.5 * 10.4 *
 beste Teiler: 59.2 (45.), 110.3 (49.), 133.7 (50.)
 Trefferlage: 0.87 mm links, 0.26 mm hoch
 Streuwert: 1.63, horizontal: 2.22, vertikal: 0.64

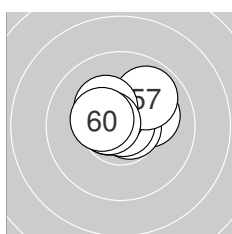

Serie 6:
 10.1 → 10.7 * 10.5 * 10.6 * 10.9 *
 10.6 * 9.9 ↗ 10.3 * 10.6 * 10.4 *
 beste Teiler: 20.5 (55.), 63.6 (52.), 81.4 (54.)
 Trefferlage: 0.03 mm links, 0.68 mm hoch
 Streuwert: 0.93, horizontal: 1.15, vertikal: 0.64

