

Ergebnis: **312.8** (299)
Serien: 105.0 104.5 103.3
Zähler: 29 1 0 0 0 0 0 0 0
Innenzehner: 26
Weiteste: 319 (25.), 232 (10.), 211 (20.)
beste Teiler: 28.1 (4.), 28.7 (16.), 51.2 (5.)
Trefferlage: 0.14 mm rechts, 0.22 mm hoch
Streuwert: 1.02, horizontal: 0.82, vertikal: 1.20

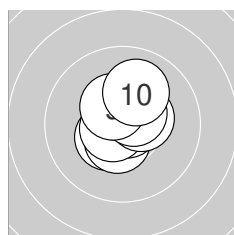

Serie 1:
 10.4 * 10.6 * 10.5 * 10.8 * 10.7 *
 10.7 * 10.4 * 10.5 * 10.4 * 10.0 †
beste Teiler: 28.1 (4.), 51.2 (5.), 71.6 (6.)
Trefferlage: 0.01 mm links, 0.32 mm hoch
Streuwert: 0.86, horizontal: 0.76, vertikal: 0.95

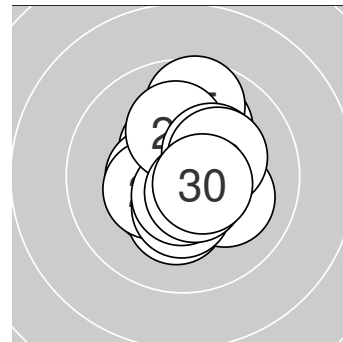
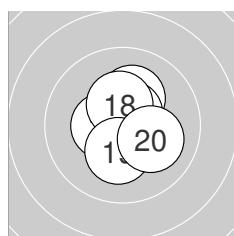

Serie 2:
 10.4 * 10.5 * 10.7 * 10.2 * 10.6 *
 10.8 * 10.5 * 10.4 * 10.3 * 10.1 ↘
beste Teiler: 28.7 (16.), 66.3 (13.), 89.6 (15.)
Trefferlage: 0.13 mm rechts, 0.09 mm tief
Streuwert: 1.04, horizontal: 0.90, vertikal: 1.16

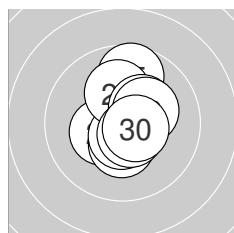

Serie 3:
 10.4 * 10.4 * 10.6 * 10.4 * 9.7 †
 10.1 † 10.3 * 10.2 * 10.6 * 10.6 *
beste Teiler: 87.2 (23.), 89.6 (29.), 94.7 (30.)
Trefferlage: 0.32 mm rechts, 0.44 mm hoch
Streuwert: 1.20, horizontal: 0.84, vertikal: 1.47



Ergebnis: **308.5** (298)
Serien: 102.6 103.2 102.7
Zähler: 28 2 0 0 0 0 0 0 0 0
Innenzehner: 21
Weiteste: 291 (18.), 264 (22.), 249 (25.)
beste Teiler: 49.5 (20.), 64.7 (4.), 75.6 (23.)
Trefferlage: 0.23 mm rechts, 0.66 mm hoch
Streuwert: 1.18, horizontal: 1.17, vertikal: 1.20

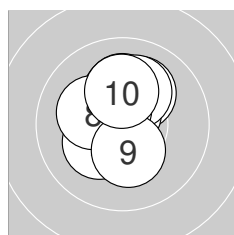
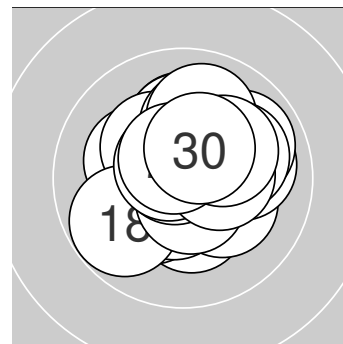

Serie 1:
 10.1 ↑ 10.2 * 10.1 ↗ 10.7 * 10.2 *
 10.1 ↗ 10.5 * 10.2 * 10.3 * 10.2 *
beste Teiler: 64.7 (4.), 102.8 (7.), 161.8 (9.)
Trefferlage: 0.17 mm links, 0.93 mm hoch
Streuwert: 1.12, horizontal: 0.87, vertikal: 1.32

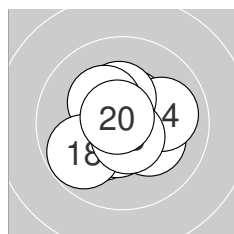

Serie 2:
 10.5 * 10.2 * 10.2 * 10.0 → 10.5 *
 10.3 * 10.3 * 9.8 ↙ 10.6 * 10.8 *
beste Teiler: 49.5 (20.), 88.0 (19.), 111.0 (15.)
Trefferlage: 0.08 mm links, 0.11 mm tief
Streuwert: 1.28, horizontal: 1.37, vertikal: 1.17

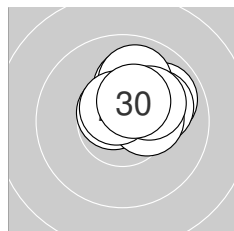

Serie 3:
 10.3 * 9.9 ↘ 10.7 * 10.1 ↑ 10.0 ↑
 10.1 ↘ 10.4 * 10.2 * 10.6 * 10.4 *
beste Teiler: 75.6 (23.), 88.1 (29.), 138.3 (30.)
Trefferlage: 0.96 mm rechts, 1.16 mm hoch
Streuwert: 0.82, horizontal: 0.95, vertikal: 0.67



Ergebnis: **311.7** (297)
 Serien: 103.5 105.0 103.2
 Zähler: 27 3 0 0 0 0 0 0 0 0
 Innenzehner: 23
 Weitester: 297 (22.), 280 (7.), 274 (30.)
 beste Teiler: 24.3 (12.), 39.4 (11.), 63.9 (1.)
 Trefferlage: 0.03 mm rechts, 0.09 mm tief
 Streuwert: 1.14, horizontal: 1.26, vertikal: 0.99

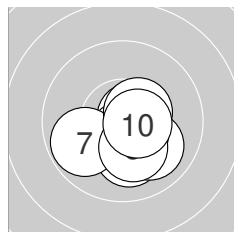
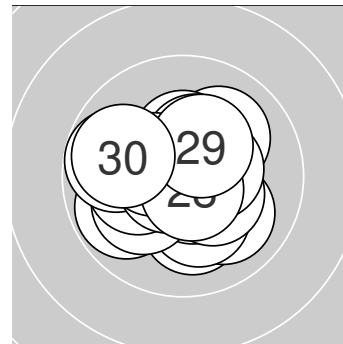

Serie 1:

10.7 *	10.5 *	10.1 ↓	10.0 ↘	10.5 *
10.6 *	9.8 ↙	10.2 *	10.5 *	10.6 *

beste Teiler: 63.9 (1.), 91.1 (6.), 98.1 (10.)
 Trefferlage: 0.45 mm rechts, 0.84 mm tief
 Streuwert: 1.00, horizontal: 1.12, vertikal: 0.87

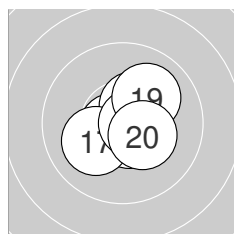

Serie 2:

10.8 *	10.9 *	10.6 *	10.7 *	10.5 *
10.4 *	10.1 ↙	10.7 *	10.0 ↗	10.3 *

beste Teiler: 24.3 (12.), 39.4 (11.), 65.3 (14.)
 Trefferlage: 0.28 mm rechts, 0.00 mm
 Streuwert: 0.93, horizontal: 0.96, vertikal: 0.90

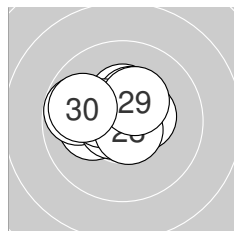

Serie 3:

10.2 *	9.8 ↙	10.4 *	10.4 *	10.4 *
10.7 *	10.4 *	10.7 *	10.3 *	9.9 ↙

beste Teiler: 67.0 (26.), 69.0 (28.), 130.7 (23.)
 Trefferlage: 0.63 mm links, 0.53 mm hoch
 Streuwert: 1.17, horizontal: 1.48, vertikal: 0.73



Ergebnis: **310.2** (295)
 Serien: 103.0 100.8 106.4
 Zähler: 25 5 0 0 0 0 0 0 0 0
 Innenzehner: 23
 Weitesten: 416 (17.), 371 (11.), 322 (6.)
 beste Teiler: 10.4 (25.), 10.6 (26.), 28.0 (24.)
 Trefferlage: 0.03 mm rechts, 0.11 mm hoch
 Streuwert: 1.30, horizontal: 1.57, vertikal: 0.97

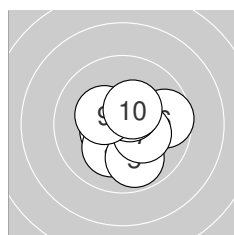
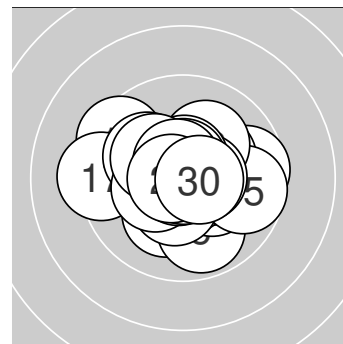

Serie 1:

10.5 *	10.6 *	10.6 *	10.2 *	9.9 ↓
9.7 →	10.3 *	10.5 *	10.3 *	10.4 *

beste Teiler: 77.1 (3.), 98.3 (2.), 106.3 (8.)
 Trefferlage: 0.53 mm rechts, 0.26 mm tief
 Streuwert: 1.27, horizontal: 1.36, vertikal: 1.19

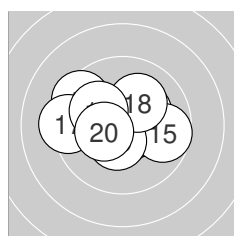

Serie 2:

9.5 ↘	10.4 *	10.2 *	10.7 *	9.7 →
10.4 *	9.3 ←	10.1 ↗	10.1 ↘	10.4 *

beste Teiler: 63.3 (14.), 126.1 (16.), 127.1 (12.)
 Trefferlage: 0.38 mm links, 0.28 mm hoch
 Streuwert: 1.77, horizontal: 2.26, vertikal: 1.08

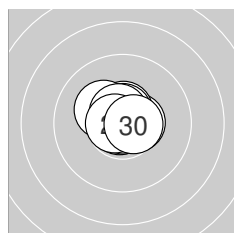

Serie 3:

10.5 *	10.6 *	10.2 *	10.8 *	10.9 *
10.9 *	10.6 *	10.6 *	10.7 *	10.6 *

beste Teiler: 10.4 (25.), 10.6 (26.), 28.0 (24.)
 Trefferlage: 0.05 mm links, 0.32 mm hoch
 Streuwert: 0.60, horizontal: 0.69, vertikal: 0.49



ISSF AR Mixed Quali – Wertung offene Klasse

StartNr: 37

StandNr: 106

2. November 2022 14:49

Marlene, Pribitzer #70507091

AUT 4

Ergebnis: **314.0** (297)
Serien: 104.4 104.6 105.0
Zähler: 27 3 0 0 0 0 0 0 0 0
Innenzehner: 27
Weiteste: 279 (19.), 269 (8.), 258 (25.)
beste Teiler: 23.7 (29.), 48.4 (22.), 51.1 (1.)
Trefferlage: 0.15 mm links, 0.06 mm hoch
Streuwert: 0.98, horizontal: 1.08, vertikal: 0.87

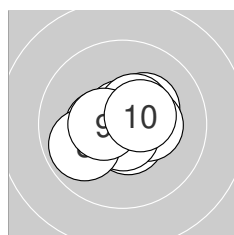
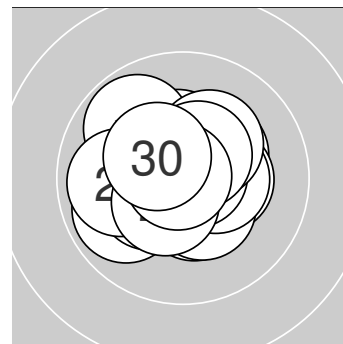

Serie 1:

10.7 *	10.3 *	10.6 *	10.5 *	10.3 *
10.4 *	10.7 *	9.9 ←	10.5 *	10.5 *

beste Teiler: 51.1 (1.), 66.1 (7.), 96.9 (3.)
Trefferlage: 0.00 mm , 0.01 mm tief
Streuwert: 1.06, horizontal: 1.29, vertikal: 0.76

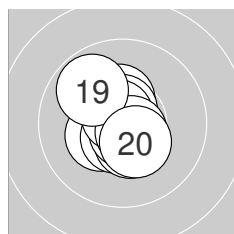

Serie 2:

10.3 *	10.6 *	10.4 *	10.7 *	10.4 *
10.6 *	10.7 *	10.7 *	9.8 ↘	10.4 *

beste Teiler: 55.7 (14.), 58.8 (17.), 74.9 (18.)
Trefferlage: 0.23 mm links, 0.02 mm tief
Streuwert: 1.01, horizontal: 0.84, vertikal: 1.15

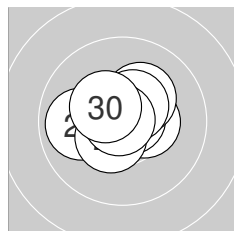

Serie 3:

10.4 *	10.8 *	10.7 *	10.7 *	9.9 ←
10.2 *	10.5 *	10.5 *	10.9 *	10.4 *

beste Teiler: 23.7 (29.), 48.4 (22.), 57.0 (24.)
Trefferlage: 0.23 mm links, 0.24 mm hoch
Streuwert: 0.96, horizontal: 1.17, vertikal: 0.68



Ergebnis: **312.0** (295)
 Serien: 104.1 103.6 104.3
 Zähler: 26 3 1 0 0 0 0 0 0
 Innenzehner: 23
 Weitester: 511 (13.), 361 (28.), 327 (18.)
 beste Teiler: 18.6 (17.), 30.0 (19.), 36.0 (9.)
 Trefferlage: 0.02 mm links, 0.06 mm tief
 Streuwert: 1.27, horizontal: 1.52, vertikal: 0.95

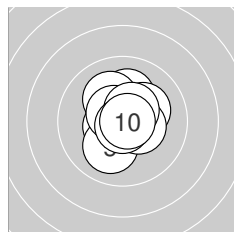
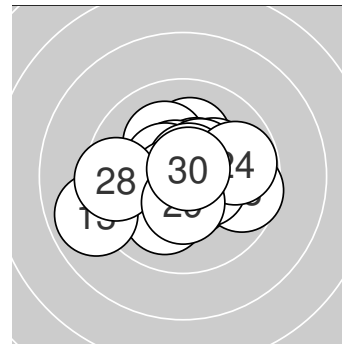

Serie 1:

10.1 ↑	10.2 *	10.5 *	10.1 ↖	10.1 ↙
10.6 *	10.4 *	10.5 *	10.8 *	10.8 *

beste Teiler: 36.0 (9.), 39.0 (10.), 96.2 (6.)
 Trefferlage: 0.07 mm rechts, 0.30 mm hoch
 Streuwert: 1.08, horizontal: 0.97, vertikal: 1.19

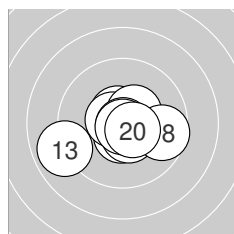

Serie 2:

10.6 *	10.6 *	8.9 ↙	10.5 *	10.6 *
10.5 *	10.9 *	9.6 →	10.8 *	10.6 *

beste Teiler: 18.6 (17.), 30.0 (19.), 83.8 (15.)
 Trefferlage: 0.05 mm links, 0.39 mm tief
 Streuwert: 1.52, horizontal: 1.96, vertikal: 0.88

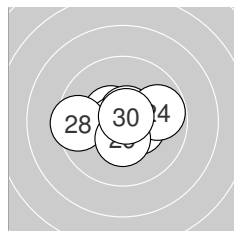

Serie 3:

10.4 *	10.5 *	10.7 *	9.8 →	10.8 *
10.7 *	10.7 *	9.5 ←	10.4 *	10.8 *

beste Teiler: 45.3 (25.), 48.6 (30.), 64.4 (26.)
 Trefferlage: 0.08 mm links, 0.11 mm tief
 Streuwert: 1.25, horizontal: 1.63, vertikal: 0.69



Ergebnis: **299.7** (288)
 Serien: 100.5 99.0 100.2
 Zähler: 20 8 2 0 0 0 0 0 0
 Innenzehner: 17
 Weitesten: 610 (28.), 517 (15.), 497 (17.)
 beste Teiler: 73.1 (26.), 79.0 (1.), 105.3 (14.)
 Trefferlage: 0.46 mm rechts, 0.25 mm hoch
 Streuwert: 1.94, horizontal: 2.20, vertikal: 1.63

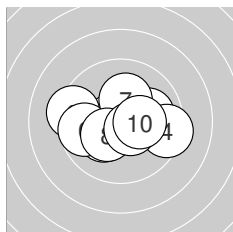
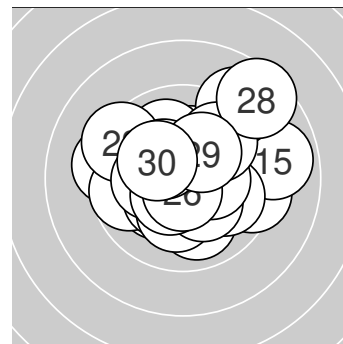

Serie 1:

10.6 *	9.3 ←	10.0 →	9.4 →	10.2 *
9.7 ←	10.2 *	10.3 *	10.5 *	10.3 *

beste Teiler: 79.0 (1.), 106.2 (9.), 160.5 (8.)
 Trefferlage: 0.13 mm links, 0.14 mm tief
 Streuwert: 1.84, horizontal: 2.42, vertikal: 0.96

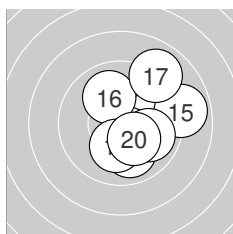

Serie 2:

10.0 ↓	9.9 →	10.3 *	10.5 *	8.9 →
10.0 ↖	9.0 ↗	10.2 *	9.9 ↘	10.3 *

beste Teiler: 105.3 (14.), 156.8 (13.), 173.7 (20.)
 Trefferlage: 1.50 mm rechts, 0.10 mm tief
 Streuwert: 1.89, horizontal: 1.76, vertikal: 2.00

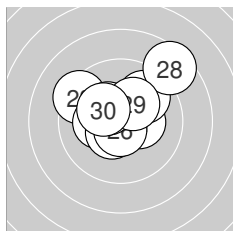

Serie 3:

10.3 *	9.8 ↗	9.4 ↖	10.2 *	10.5 *
10.7 *	10.3 *	8.5 ↗	10.2 *	10.3 *

beste Teiler: 73.1 (26.), 119.2 (25.), 151.3 (27.)
 Trefferlage: 0.01 mm rechts, 1.01 mm hoch
 Streuwert: 1.93, horizontal: 2.20, vertikal: 1.62



ISSF AR Mixed Quali – Wertung offene Klasse

StartNr: 40

StandNr: 109

2. November 2022 14:46

Greber, Chiara #70507088

Vorarlberg

Ergebnis: **296.3** (281)
 Serien: 96.7 101.2 98.4
 Zähler: 13 15 2 0 0 0 0 0 0
 Innenzehner: 11
 Weitestе: 532 (28.), 501 (6.), 435 (2.)
 beste Teiler: 29.5 (27.), 40.4 (20.), 100.8 (14.)
 Trefferlage: 0.81 mm links, 0.32 mm hoch
 Streuwert: 2.05, horizontal: 2.33, vertikal: 1.72

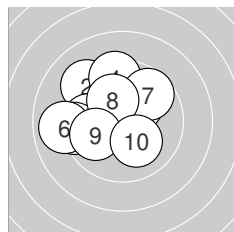
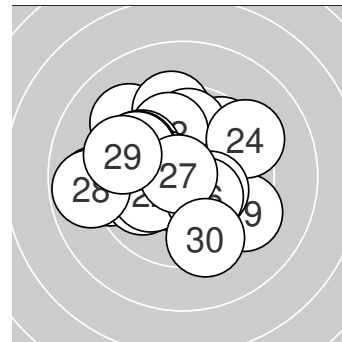

Serie 1:

10.2 *	9.2 ↘	9.8 ←	9.4 ↑	9.3 ←
8.9 ←	9.7 ↗	10.2 *	9.9 ↙	10.1 ↘

beste Teiler: 183.3 (1.), 200.8 (8.), 207.7 (10.)
 Trefferlage: 1.44 mm links, 0.84 mm hoch
 Streuwert: 2.18, horizontal: 2.45, vertikal: 1.88

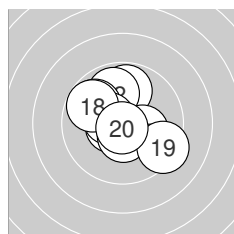

Serie 2:

9.8 ↑	9.9 ↑	9.8 ↘	10.6 *	10.2 *
10.5 *	10.5 *	9.8 ↘	9.3 ↘	10.8 *

beste Teiler: 40.4 (20.), 100.8 (14.), 113.2 (17.)
 Trefferlage: 0.24 mm links, 0.41 mm hoch
 Streuwert: 1.72, horizontal: 1.82, vertikal: 1.62

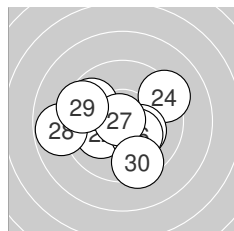

Serie 3:

10.2 *	10.1 ←	9.7 ↘	9.3 ↗	10.3 *
10.3 *	10.8 *	8.8 ←	9.5 ↘	9.4 ↘

beste Teiler: 29.5 (27.), 169.0 (26.), 173.1 (25.)
 Trefferlage: 0.77 mm links, 0.29 mm tief
 Streuwert: 2.24, horizontal: 2.71, vertikal: 1.63



ISSF AR Mixed Quali – Wertung offene Klasse

StartNr: 41

StandNr: 110

2. November 2022 14:45

Kitzbichler, Jasmin #190

AUT 3

Ergebnis: **313.4** (299)
 Serien: 103.9 103.9 105.6
 Zähler: 29 1 0 0 0 0 0 0 0 0
 Innenzehner: 26
 Weitester: 258 (23.), 214 (3.), 214 (18.)
 beste Teiler: 1.0 (6.), 21.1 (25.), 50.9 (1.)
 Trefferlage: 0.14 mm links, 0.50 mm hoch
 Streuwert: 0.92, horizontal: 0.85, vertikal: 0.99

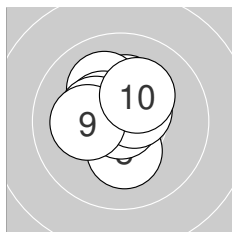
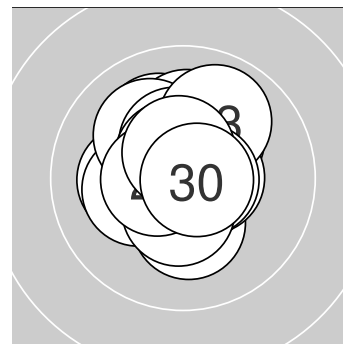

Serie 1:

10.8 *	10.3 *	10.1 ↘	10.4 *	10.2 *
10.9 *	10.3 *	10.5 *	10.2 *	10.2 *

beste Teiler: 1.0 (6.), 50.9 (1.), 104.0 (8.)
 Trefferlage: 0.34 mm links, 0.54 mm hoch
 Streuwert: 1.03, horizontal: 0.98, vertikal: 1.07

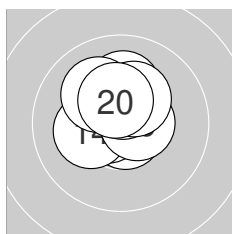

Serie 2:

10.7 *	10.1 ↑	10.6 *	10.2 *	10.5 *
10.6 *	10.4 *	10.1 ↘	10.3 *	10.4 *

beste Teiler: 57.8 (11.), 80.0 (13.), 99.0 (16.)
 Trefferlage: 0.14 mm links, 0.78 mm hoch
 Streuwert: 0.92, horizontal: 0.90, vertikal: 0.95

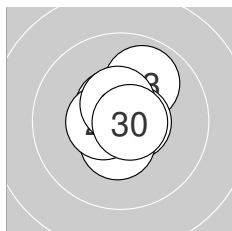

Serie 3:

10.7 *	10.7 *	9.9 ↗	10.6 *	10.9 *
10.6 *	10.5 *	10.5 *	10.5 *	10.7 *

beste Teiler: 21.1 (25.), 55.4 (30.), 57.7 (21.)
 Trefferlage: 0.04 mm rechts, 0.18 mm hoch
 Streuwert: 0.83, horizontal: 0.68, vertikal: 0.96



ISSF AR Mixed Quali – Wertung offene Klasse

StartNr: 42

StandNr: 111

2. November 2022 14:46

Zott, Georg #70507092

AUT 3

Ergebnis: **312.0** (296)
 Serien: 104.0 104.1 103.9
 Zähler: 26 4 0 0 0 0 0 0 0 0
 Innenzehner: 25
 Weitesten: 366 (7.), 322 (16.), 265 (17.)
 beste Teiler: 36.0 (22.), 41.7 (15.), 47.1 (13.)
 Trefferlage: 0.32 mm rechts, 0.17 mm tief
 Streuwert: 1.13, horizontal: 1.20, vertikal: 1.05

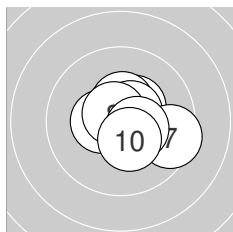
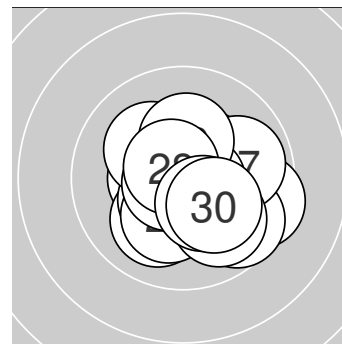

Serie 1:

10.7 *	10.4 *	10.4 *	10.5 *	10.6 *
10.4 *	9.5 ↘	10.7 *	10.4 *	10.4 *

beste Teiler: 52.0 (1.), 71.5 (8.), 93.6 (5.)
 Trefferlage: 0.58 mm rechts, 0.00 mm
 Streuwert: 1.11, horizontal: 1.31, vertikal: 0.86

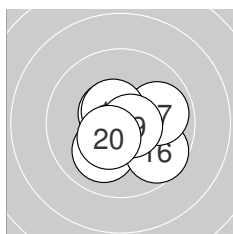

Serie 2:

10.5 *	10.8 *	10.8 *	10.0 ✓	10.8 *
9.7 ↘	9.9 →	10.5 *	10.7 *	10.4 *

beste Teiler: 41.7 (15.), 47.1 (13.), 50.8 (12.)
 Trefferlage: 0.35 mm rechts, 0.32 mm tief
 Streuwert: 1.18, horizontal: 1.32, vertikal: 1.03

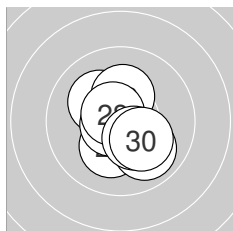

Serie 3:

10.6 *	10.8 *	10.2 *	10.2 *	10.7 *
10.3 *	9.9 ↘	10.7 *	10.3 *	10.2 *

beste Teiler: 36.0 (22.), 67.0 (25.), 75.6 (28.)
 Trefferlage: 0.04 mm rechts, 0.18 mm tief
 Streuwert: 1.17, horizontal: 1.02, vertikal: 1.31



ISSF AR Mixed Quali – Wertung offene Klasse

StartNr: 43

StandNr: 112

2. November 2022 14:44

Machova, Lucie #70507084

CZE 3

Ergebnis: **307.7** (291)
 Serien: 101.1 104.1 102.5
 Zähler: 21 9 0 0 0 0 0 0 0
 Innenzehner: 20
 Weitester: 436 (1.), 343 (8.), 337 (10.)
 beste Teiler: 11.7 (18.), 25.0 (25.), 39.1 (17.)
 Trefferlage: 0.12 mm rechts, 0.02 mm hoch
 Streuwert: 1.47, horizontal: 1.86, vertikal: 0.91

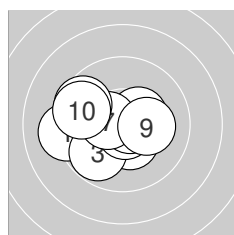
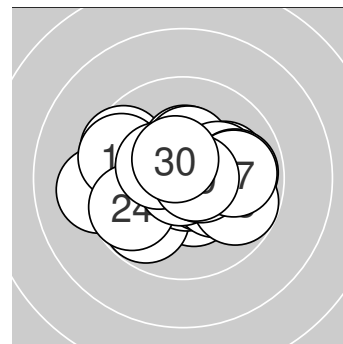

Serie 1:

9.2 ←	10.4 *	9.8 ↙	10.7 *	10.7 *
10.4 *	10.5 *	9.6 ↘	10.2 *	9.6 ↖

beste Teiler: 52.5 (4.), 58.0 (5.), 118.6 (7.)
 Trefferlage: 0.92 mm links, 0.11 mm tief
 Streuwert: 1.69, horizontal: 2.12, vertikal: 1.09

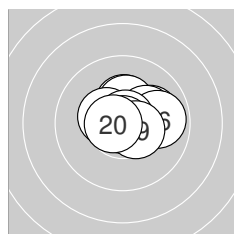

Serie 2:

10.1 →	10.3 *	10.3 *	10.4 *	10.2 *
9.9 →	10.8 *	10.9 *	10.5 *	10.7 *

beste Teiler: 11.7 (18.), 39.1 (17.), 73.1 (20.)
 Trefferlage: 0.62 mm rechts, 0.48 mm hoch
 Streuwert: 1.01, horizontal: 1.26, vertikal: 0.66

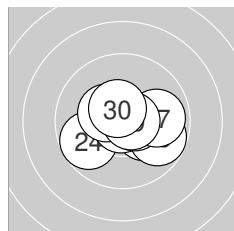

Serie 3:

10.2 *	9.8 ↘	9.8 ↘	9.7 ↙	10.9 *
10.6 *	9.9 →	10.4 *	10.7 *	10.5 *

beste Teiler: 25.0 (25.), 66.0 (29.), 94.1 (26.)
 Trefferlage: 0.68 mm rechts, 0.28 mm tief
 Streuwert: 1.40, horizontal: 1.80, vertikal: 0.81



ISSF AR Mixed Quali – Wertung offene Klasse

StartNr: 44

StandNr: 113

2. November 2022 14:43

Krivanek, Richard #70507078

CZE 3

Ergebnis: **308.5** (296)
 Serien: 103.0 101.7 103.8
 Zähler: 26 4 0 0 0 0 0 0 0
 Innenzehner: 21
 Weitesten: 450 (20.), 321 (18.), 303 (7.)
 beste Teiler: 42.4 (22.), 51.0 (27.), 57.3 (8.)
 Trefferlage: 0.33 mm rechts, 0.04 mm tief
 Streuwert: 1.34, horizontal: 1.42, vertikal: 1.26

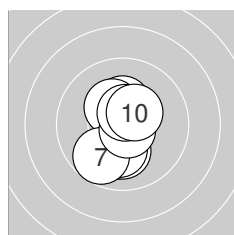
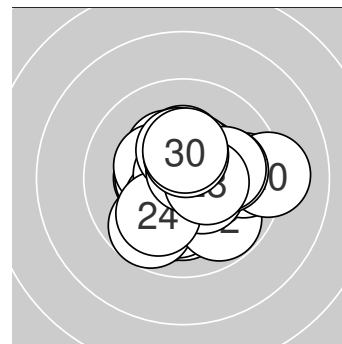

Serie 1:

10.6 *	10.3 *	10.3 *	10.1 ↓	10.1 ↓
10.2 *	9.7 ↙	10.7 *	10.6 *	10.4 *

beste Teiler: 57.3 (8.), 93.6 (9.), 98.4 (1.)
 Trefferlage: 0.12 mm links, 0.34 mm tief
 Streuwert: 1.29, horizontal: 0.75, vertikal: 1.66

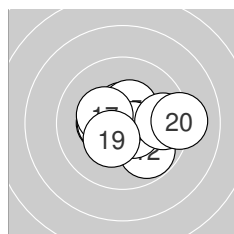

Serie 2:

10.4 *	9.8 ↘	10.4 *	10.6 *	10.4 *
10.6 *	10.3 *	9.7 →	10.3 *	9.2 →

beste Teiler: 98.1 (16.), 100.0 (14.), 131.0 (15.)
 Trefferlage: 0.58 mm rechts, 0.07 mm tief
 Streuwert: 1.63, horizontal: 2.07, vertikal: 1.01

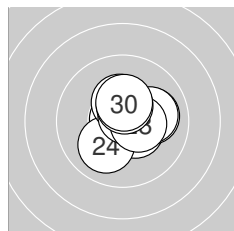

Serie 3:

10.5 *	10.8 *	10.0 →	10.0 ✓	10.1 →
10.4 *	10.7 *	10.4 *	10.5 *	10.4 *

beste Teiler: 42.4 (22.), 51.0 (27.), 123.1 (21.)
 Trefferlage: 0.53 mm rechts, 0.29 mm hoch
 Streuwert: 1.08, horizontal: 1.13, vertikal: 1.03



Ergebnis: **310.5** (297)
 Serien: 103.3 104.1 103.1
 Zähler: 27 3 0 0 0 0 0 0 0 0
 Innenzehner: 24
 Weitesten: 399 (2.), 364 (30.), 256 (9.)
 beste Teiler: 41.0 (10.), 42.4 (18.), 50.1 (3.)
 Trefferlage: 0.16 mm rechts, 0.58 mm hoch
 Streuwert: 1.16, horizontal: 1.40, vertikal: 0.85

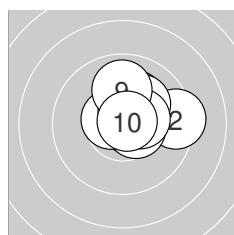
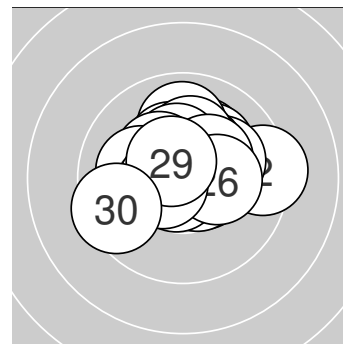

Serie 1:

10.2 *	9.4 →	10.8 *	10.5 *	10.1 ↗
10.6 *	10.6 *	10.4 *	9.9 ↑	10.8 *

beste Teiler: 41.0 (10.), 50.1 (3.), 94.0 (6.)
 Trefferlage: 0.88 mm rechts, 0.79 mm hoch
 Streuwert: 1.10, horizontal: 1.27, vertikal: 0.90

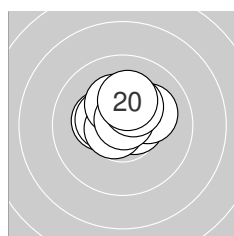

Serie 2:

10.6 *	10.4 *	10.3 *	10.4 *	10.1 ↗
10.7 *	10.3 *	10.8 *	10.3 *	10.2 *

beste Teiler: 42.4 (18.), 68.1 (16.), 87.2 (11.)
 Trefferlage: 0.10 mm rechts, 0.75 mm hoch
 Streuwert: 0.93, horizontal: 1.12, vertikal: 0.68

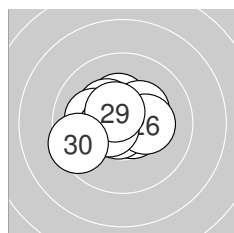

Serie 3:

10.6 *	10.3 *	10.3 *	10.7 *	10.3 *
10.3 *	10.1 ←	10.5 *	10.5 *	9.5 ↙

beste Teiler: 54.2 (24.), 82.3 (21.), 102.0 (29.)
 Trefferlage: 0.51 mm links, 0.20 mm hoch
 Streuwert: 1.25, horizontal: 1.52, vertikal: 0.90



Ergebnis: **314.0** (299)
Serien: 104.8 103.8 105.4
Zähler: 29 1 0 0 0 0 0 0 0 0
Innenzehner: 25
Weiteste: 273 (3.), 237 (18.), 224 (15.)
beste Teiler: 40.7 (9.), 41.6 (29.), 42.5 (11.)
Trefferlage: 0.17 mm rechts, 0.11 mm hoch
Streuwert: 0.99, horizontal: 0.93, vertikal: 1.04

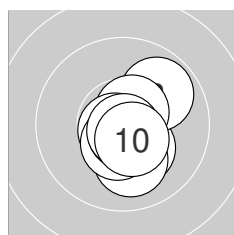
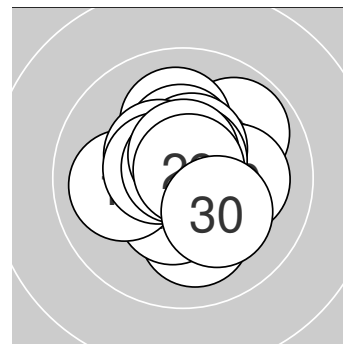

Serie 1:

10.3 *	10.1 ↓	9.9 ↗	10.7 *	10.6 *
10.7 *	10.5 *	10.7 *	10.8 *	10.5 *

beste Teiler: 40.7 (9.), 51.6 (8.), 58.4 (6.)
Trefferlage: 0.41 mm rechts, 0.49 mm tief
Streuwert: 0.93, horizontal: 0.71, vertikal: 1.11

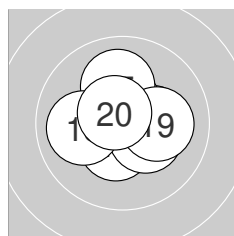

Serie 2:

10.8 *	10.3 *	10.5 *	10.7 *	10.1 ↑
10.4 *	10.3 *	10.0 ←	10.1 →	10.6 *

beste Teiler: 42.5 (11.), 74.5 (14.), 79.8 (20.)
Trefferlage: 0.11 mm rechts, 0.27 mm hoch
Streuwert: 1.16, horizontal: 1.31, vertikal: 0.98

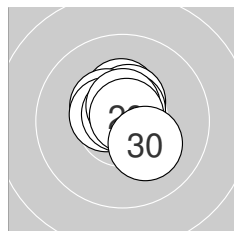

Serie 3:

10.3 *	10.5 *	10.7 *	10.4 *	10.5 *
10.8 *	10.6 *	10.6 *	10.8 *	10.2 *

beste Teiler: 41.6 (29.), 48.3 (26.), 74.2 (23.)
Trefferlage: 0.00 mm, 0.58 mm hoch
Streuwert: 0.73, horizontal: 0.68, vertikal: 0.77



ISSF AR Mixed Quali – Wertung offene Klasse

StartNr: 47

StandNr: 116

2. November 2022 14:47

Brabcova, Aneta #70507093

CZE 1

Ergebnis: 317.3 (300)
Serien: 106.2 105.6 105.5
Zähler: 30 0 0 0 0 0 0 0 0 0
Innenzehner: 29
Weiteste: 217 (21.), 178 (17.), 164 (25.)
beste Teiler: 18.3 (22.), 23.8 (3.), 39.1 (13.)
Trefferlage: 0.02 mm links, 0.01 mm tief
Streuwert: 0.75, horizontal: 0.72, vertikal: 0.79

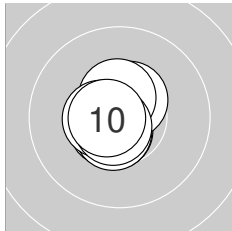
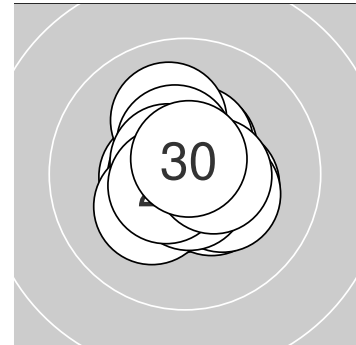

Serie 1:

10.6 *	10.6 *	10.9 *	10.6 *	10.6 *
10.5 *	10.5 *	10.5 *	10.7 *	10.7 *

beste Teiler: 23.8 (3.), 66.0 (9.), 74.1 (10.)
Trefferlage: 0.32 mm links, 0.03 mm hoch
Streuwert: 0.63, horizontal: 0.46, vertikal: 0.76

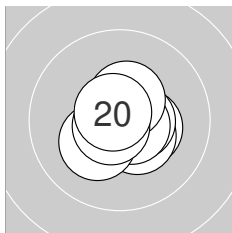

Serie 2:

10.4 *	10.6 *	10.8 *	10.4 *	10.6 *
10.7 *	10.2 *	10.5 *	10.7 *	10.7 *

beste Teiler: 39.1 (13.), 60.3 (20.), 60.4 (19.)
Trefferlage: 0.19 mm rechts, 0.28 mm tief
Streuwert: 0.77, horizontal: 0.85, vertikal: 0.69

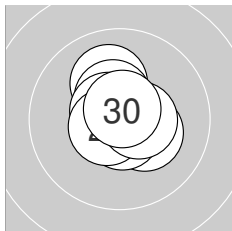

Serie 3:

10.1 †	10.9 *	10.4 *	10.7 *	10.3 *
10.7 *	10.6 *	10.6 *	10.5 *	10.7 *

beste Teiler: 18.3 (22.), 53.7 (24.), 60.8 (30.)
Trefferlage: 0.07 mm rechts, 0.18 mm hoch
Streuwert: 0.83, horizontal: 0.75, vertikal: 0.91



ISSF AR Mixed Quali – Wertung offene Klasse

StartNr: 48

StandNr: 117

2. November 2022 14:49

Nepejchal, Filip #70507094

CZE 1

Ergebnis: **311.4** (300)
 Serien: 103.5 103.1 104.8
 Zähler: 30 0 0 0 0 0 0 0 0
 Innenzehner: 25
 Weitesten: 244 (17.), 238 (16.), 226 (15.)
 beste Teiler: 19.3 (19.), 35.8 (22.), 54.4 (14.)
 Trefferlage: 0.03 mm links, 0.00 mm
 Streuwert: 1.13, horizontal: 1.13, vertikal: 1.12

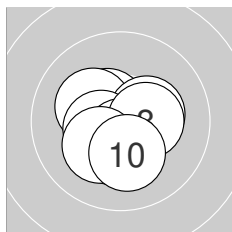
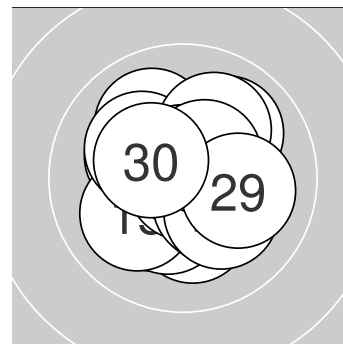

Serie 1:

10.5 *	10.3 *	10.2 *	10.3 *	10.3 *
10.5 *	10.6 *	10.4 *	10.2 *	10.2 *
beste Teiler: 91.3 (7.), 115.3 (1.), 121.8 (6.)				
Trefferlage: 0.24 mm links, 0.53 mm tief				
Streuwert: 1.06, horizontal: 1.09, vertikal: 1.02				

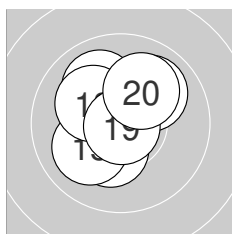

Serie 2:

10.4 *	10.5 *	10.3 *	10.7 *	10.0 ↙
10.0 ↘	10.0 ↗	10.2 *	10.9 *	10.1 ↗
beste Teiler: 19.3 (19.), 54.4 (14.), 107.5 (12.)				
Trefferlage: 0.46 mm links, 0.56 mm hoch				
Streuwert: 1.22, horizontal: 1.15, vertikal: 1.28				

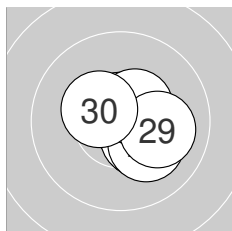

Serie 3:

10.7 *	10.8 *	10.3 *	10.7 *	10.7 *
10.4 *	10.2 *	10.5 *	10.1 →	10.4 *
beste Teiler: 35.8 (22.), 58.2 (25.), 61.0 (21.)				
Trefferlage: 0.61 mm rechts, 0.04 mm tief				
Streuwert: 0.89, horizontal: 0.96, vertikal: 0.83				



ISSF AR Mixed Quali – Wertung offene Klasse

StartNr: 49

StandNr: 118

2. November 2022 14:52

Hofmann, Olivia #168

AUT 5

Ergebnis: **314.6** (298)
Serien: 104.6 104.4 105.6
Zähler: 28 2 0 0 0 0 0 0 0 0
Innenzehner: 27
Weiteste: 284 (11.), 264 (8.), 249 (9.)
beste Teiler: 5.0 (4.), 34.1 (19.), 53.4 (10.)
Trefferlage: 0.23 mm rechts, 0.31 mm hoch
Streuwert: 0.91, horizontal: 1.03, vertikal: 0.78

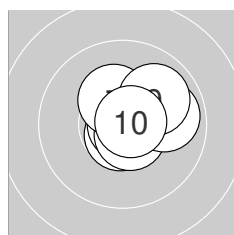
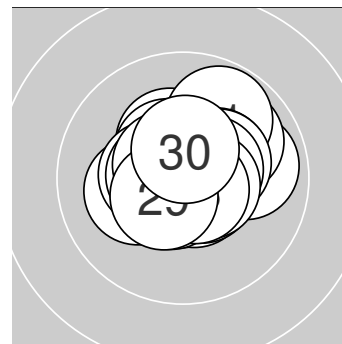

Serie 1:

10.5 *	10.4 *	10.7 *	10.9 *	10.6 *
10.6 *	10.3 *	9.9 →	10.0 ↗	10.7 *

beste Teiler: 5.0 (4.), 53.4 (10.), 67.6 (3.)
Trefferlage: 0.75 mm rechts, 0.45 mm hoch
Streuwert: 0.87, horizontal: 0.95, vertikal: 0.78

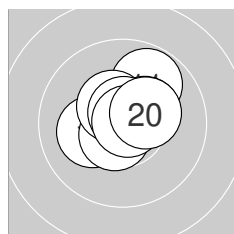

Serie 2:

9.8 ↗	10.6 *	10.6 *	10.2 *	10.6 *
10.3 *	10.5 *	10.7 *	10.8 *	10.3 *

beste Teiler: 34.1 (19.), 67.3 (18.), 79.0 (13.)
Trefferlage: 0.03 mm rechts, 0.47 mm hoch
Streuwert: 1.03, horizontal: 1.12, vertikal: 0.92

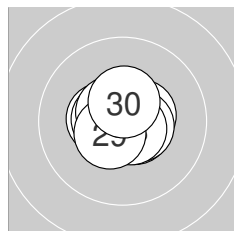

Serie 3:

10.7 *	10.5 *	10.4 *	10.6 *	10.6 *
10.5 *	10.6 *	10.7 *	10.5 *	10.5 *

beste Teiler: 68.0 (21.), 70.0 (28.), 88.8 (27.)
Trefferlage: 0.08 mm links, 0.01 mm hoch
Streuwert: 0.75, horizontal: 0.88, vertikal: 0.59



ISSF AR Mixed Quali – Wertung offene Klasse

StartNr: 50

StandNr: 119

2. November 2022 14:50

Mair, Tobias #184

AUT 5

Ergebnis: **308.8** (297)
Serien: 103.1 103.8 101.9
Zähler: 27 3 0 0 0 0 0 0 0 0
Innenzehner: 21
Weiteste: 305 (2.), 276 (13.), 273 (29.)
beste Teiler: 30.4 (19.), 35.1 (14.), 54.3 (5.)
Trefferlage: 0.23 mm links, 0.46 mm hoch
Streuwert: 1.22, horizontal: 1.23, vertikal: 1.21

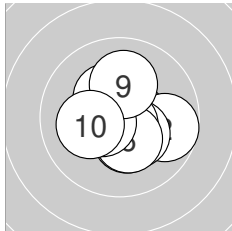
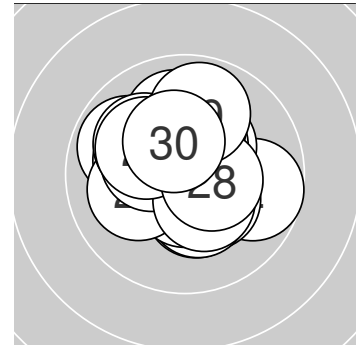

Serie 1:

10.6 *	9.7 →	10.3 *	10.4 *	10.7 *
10.3 *	10.3 *	10.5 *	10.1 ↑	10.2 *

beste Teiler: 54.3 (5.), 88.0 (1.), 119.2 (8.)
Trefferlage: 0.26 mm rechts, 0.24 mm tief
Streuwert: 1.26, horizontal: 1.36, vertikal: 1.16

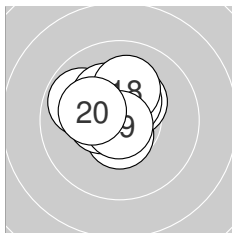

Serie 2:

10.6 *	10.4 *	9.8 ↖	10.8 *	10.5 *
10.4 *	10.2 *	10.1 ↑	10.8 *	10.2 *

beste Teiler: 30.4 (19.), 35.1 (14.), 97.0 (11.)
Trefferlage: 0.45 mm links, 0.69 mm hoch
Streuwert: 1.02, horizontal: 1.10, vertikal: 0.92

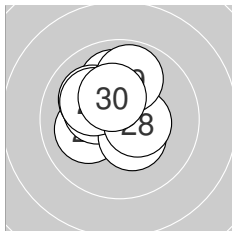

Serie 3:

10.0 ↑	10.1 ←	10.3 *	10.1 ↖	10.2 *
10.4 *	10.1 ↖	10.5 *	9.9 ↑	10.3 *

beste Teiler: 120.6 (28.), 142.4 (26.), 152.1 (30.)
Trefferlage: 0.51 mm links, 0.93 mm hoch
Streuwert: 1.24, horizontal: 1.19, vertikal: 1.28



Ergebnis: **312.1** (294)
Serien: 103.1 106.1 102.9
Zähler: 24 6 0 0 0 0 0 0 0 0
Innenzehner: 23
Weiteste: 364 (28.), 305 (9.), 297 (3.)
beste Teiler: 9.2 (15.), 27.4 (24.), 32.5 (2.)
Trefferlage: 0.34 mm rechts, 0.30 mm hoch
Streuwert: 1.15, horizontal: 1.18, vertikal: 1.11

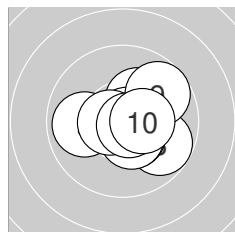
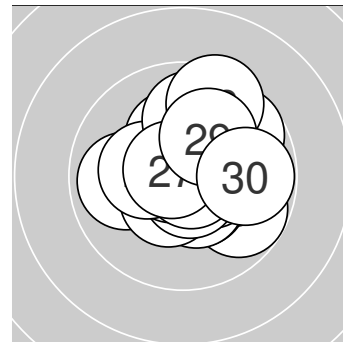

Serie 1:

10.2 *	10.8 *	9.8 ↘	10.5 *	9.9 ←
10.5 *	10.6 *	10.7 *	9.7 ↗	10.4 *

beste Teiler: 32.5 (2.), 51.6 (8.), 87.4 (7.)
Trefferlage: 0.59 mm rechts, 0.07 mm tief
Streuwert: 1.30, horizontal: 1.51, vertikal: 1.06

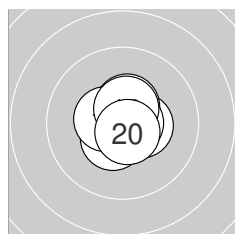

Serie 2:

10.4 *	10.7 *	10.5 *	10.5 *	10.9 *
10.7 *	10.7 *	10.5 *	10.5 *	10.7 *

beste Teiler: 9.2 (15.), 53.2 (16.), 57.4 (12.)
Trefferlage: 0.07 mm rechts, 0.01 mm tief
Streuwert: 0.68, horizontal: 0.68, vertikal: 0.68

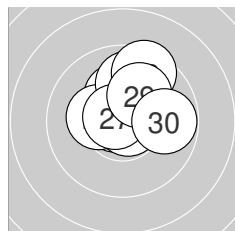

Serie 3:

10.8 *	10.2 *	10.3 *	10.8 *	9.9 ↑
10.8 *	10.7 *	9.5 ↗	10.1 ↗	9.8 →

beste Teiler: 27.4 (24.), 41.6 (26.), 48.0 (21.)
Trefferlage: 0.34 mm rechts, 0.98 mm hoch
Streuwert: 1.26, horizontal: 1.26, vertikal: 1.27



Ergebnis: **307.6** (294)
Serien: 102.4 103.2 102.0
Zähler: 25 4 1 0 0 0 0 0 0 0
Innenzehner: 18
Weiteste: 505 (9.), 385 (24.), 288 (2.)
beste Teiler: 44.9 (6.), 54.4 (16.), 54.7 (11.)
Trefferlage: 0.52 mm links, 0.62 mm hoch
Streuwert: 1.34, horizontal: 1.28, vertikal: 1.38

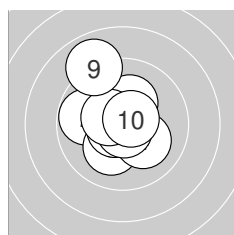
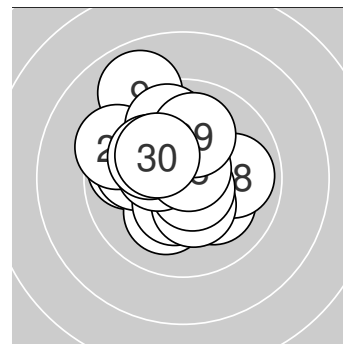

Serie 1:

10.7 *	9.8 ←	10.1 ↙	10.1 ↘	10.7 *
10.8 *	10.2 *	10.5 *	8.9 ↗	10.6 *

beste Teiler: 44.9 (6.), 63.3 (1.), 72.4 (5.)
Trefferlage: 0.48 mm links, 0.32 mm hoch
Streuwert: 1.58, horizontal: 1.36, vertikal: 1.78

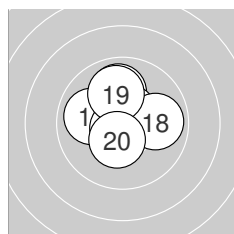

Serie 2:

10.7 *	10.5 *	10.4 *	10.0 ↑	10.0 ←
10.7 *	10.6 *	9.9 →	10.0 ↑	10.4 *

beste Teiler: 54.4 (16.), 54.7 (11.), 94.1 (17.)
Trefferlage: 0.29 mm links, 0.69 mm hoch
Streuwert: 1.21, horizontal: 1.27, vertikal: 1.13

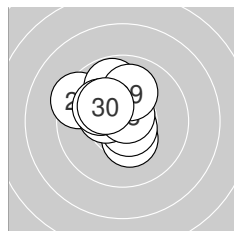

Serie 3:

10.3 *	10.4 *	10.7 *	9.4 ↖	9.8 ↗
10.4 *	10.1 ↖	10.7 *	10.0 ↑	10.2 *

beste Teiler: 57.9 (28.), 74.3 (23.), 134.6 (22.)
Trefferlage: 0.80 mm links, 0.86 mm hoch
Streuwert: 1.28, horizontal: 1.31, vertikal: 1.24



ISSF AR Mixed Quali – Wertung offene Klasse

StartNr: 53

StandNr: 122

2. November 2022 14:50

Rossiter, Jack #70507095

AUS-CZE

Ergebnis: **311.5** (296)
 Serien: 103.4 104.4 103.7
 Zähler: 26 4 0 0 0 0 0 0 0 0
 Innenzehner: 24
 Weitesten: 419 (1.), 318 (6.), 288 (23.)
 beste Teiler: 4.1 (29.), 32.2 (14.), 43.9 (7.)
 Trefferlage: 0.22 mm links, 0.54 mm hoch
 Streuwert: 1.14, horizontal: 1.20, vertikal: 1.07

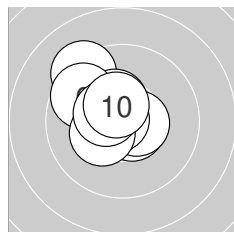
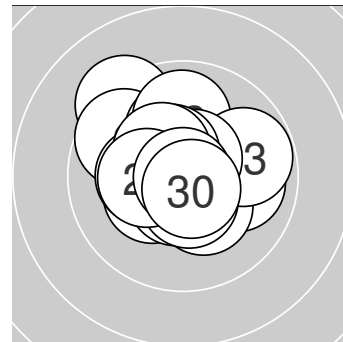

Serie 1:

9.3 ↘	10.6 *	10.6 *	10.7 *	10.4 *
9.7 ↘	10.8 *	10.3 *	10.5 *	10.5 *

beste Teiler: 43.9 (7.), 67.2 (4.), 80.8 (2.)
 Trefferlage: 0.81 mm links, 0.70 mm hoch
 Streuwert: 1.20, horizontal: 1.20, vertikal: 1.20

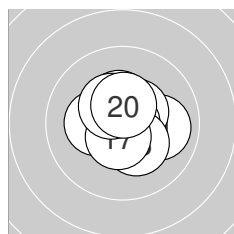

Serie 2:

10.0 →	10.3 *	10.5 *	10.8 *	10.6 *
10.3 *	10.6 *	10.4 *	10.4 *	10.5 *

beste Teiler: 32.2 (14.), 86.3 (15.), 96.7 (17.)
 Trefferlage: 0.11 mm rechts, 0.27 mm hoch
 Streuwert: 1.04, horizontal: 1.13, vertikal: 0.94

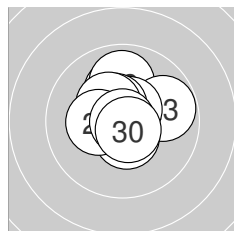

Serie 3:

10.1 ↑	9.9 ↑	9.8 →	10.6 *	10.5 *
10.5 *	10.4 *	10.3 *	10.9 *	10.7 *

beste Teiler: 4.1 (29.), 69.3 (30.), 91.7 (24.)
 Trefferlage: 0.02 mm rechts, 0.66 mm hoch
 Streuwert: 1.14, horizontal: 1.16, vertikal: 1.12



ISSF AR Mixed Quali – Wertung offene Klasse

StartNr: 54

StandNr: 123

2. November 2022 14:47

Stefankova, Katerina #70507096

AUS-CZE

Ergebnis: **314.4** (298)
 Serien: 103.4 105.0 106.0
 Zähler: 28 2 0 0 0 0 0 0 0 0
 Innenzehner: 26
 Weitesten: 286 (16.), 273 (3.), 232 (4.)
 beste Teiler: 30.0 (25.), 40.0 (19.), 47.1 (22.)
 Trefferlage: 0.22 mm rechts, 0.08 mm hoch
 Streuwert: 0.98, horizontal: 0.95, vertikal: 1.00

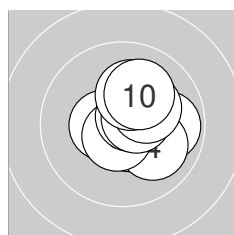
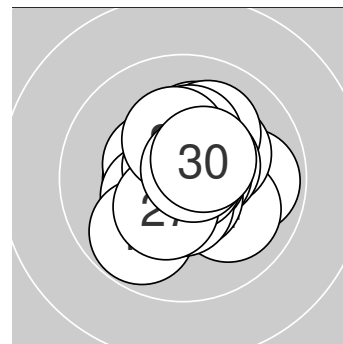

Serie 1:

10.5 *	10.6 *	9.9 →	10.0 ↘	10.6 *
10.7 *	10.6 *	10.2 *	10.2 *	10.1 ↗

beste Teiler: 72.1 (6.), 81.8 (5.), 87.2 (2.)
 Trefferlage: 0.80 mm rechts, 0.27 mm hoch
 Streuwert: 1.10, horizontal: 1.11, vertikal: 1.09

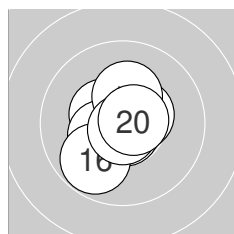

Serie 2:

10.7 *	10.6 *	10.4 *	10.8 *	10.4 *
9.8 ↙	10.5 *	10.3 *	10.8 *	10.7 *

beste Teiler: 40.0 (19.), 50.4 (14.), 64.3 (11.)
 Trefferlage: 0.23 mm links, 0.10 mm tief
 Streuwert: 1.00, horizontal: 0.92, vertikal: 1.07

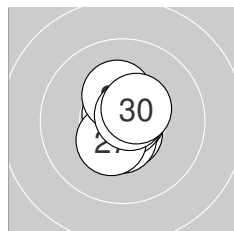

Serie 3:

10.6 *	10.8 *	10.5 *	10.7 *	10.8 *
10.7 *	10.4 *	10.3 *	10.7 *	10.5 *

beste Teiler: 30.0 (25.), 47.1 (22.), 57.2 (24.)
 Trefferlage: 0.12 mm rechts, 0.08 mm hoch
 Streuwert: 0.71, horizontal: 0.48, vertikal: 0.89



Ergebnis: **312.1** (299)
 Serien: 104.6 104.0 103.5
 Zähler: 29 1 0 0 0 0 0 0 0 0
 Innenzehner: 23
 Weitesten: 253 (12.), 240 (30.), 225 (15.)
 beste Teiler: 19.4 (28.), 62.0 (5.), 67.6 (18.)
 Trefferlage: 0.19 mm rechts, 0.45 mm hoch
 Streuwert: 1.02, horizontal: 1.18, vertikal: 0.82

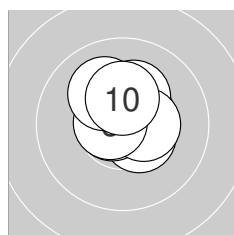
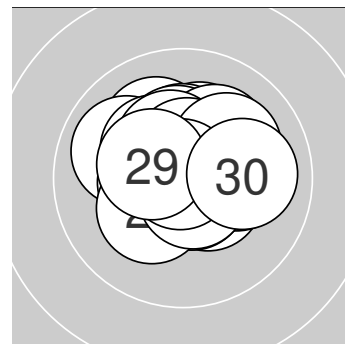

Serie 1:

10.5 *	10.6 *	10.5 *	10.2 *	10.7 *
10.6 *	10.4 *	10.7 *	10.1 ↘	10.3 *

beste Teiler: 62.0 (5.), 75.6 (8.), 86.6 (2.)
 Trefferlage: 0.20 mm rechts, 0.64 mm hoch
 Streuwert: 0.84, horizontal: 0.83, vertikal: 0.84

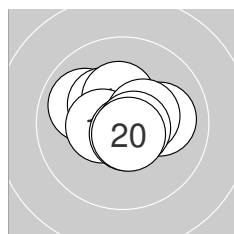

Serie 2:

10.5 *	9.9 ↙	10.3 *	10.3 *	10.1 →
10.5 *	10.4 *	10.7 *	10.7 *	10.6 *

beste Teiler: 67.6 (18.), 73.4 (19.), 76.0 (20.)
 Trefferlage: 0.12 mm links, 0.28 mm hoch
 Streuwert: 1.09, horizontal: 1.34, vertikal: 0.76

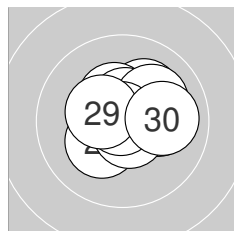

Serie 3:

10.1 →	10.3 *	10.7 *	10.1 ↗	10.4 *
10.5 *	10.1 ↗	10.9 *	10.4 *	10.0 →

beste Teiler: 19.4 (28.), 74.3 (23.), 102.2 (26.)
 Trefferlage: 0.50 mm rechts, 0.42 mm hoch
 Streuwert: 1.14, horizontal: 1.34, vertikal: 0.89



ISSF AR Mixed Quali – Wertung offene Klasse

StartNr: 56

StandNr: 125

2. November 2022 14:42

Kupec, Ondrej #70507098

CZE 4

Ergebnis: **309.1** (295)
 Serien: 102.3 102.8 104.0
 Zähler: 25 5 0 0 0 0 0 0 0 0
 Innenzehner: 21
 Weitesten: 382 (5.), 295 (16.), 270 (6.)
 beste Teiler: 27.0 (11.), 44.0 (9.), 73.5 (17.)
 Trefferlage: 0.00 mm , 0.03 mm tief
 Streuwert: 1.30, horizontal: 1.27, vertikal: 1.33

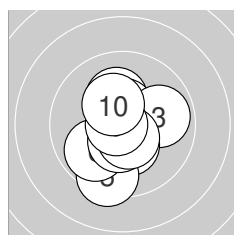
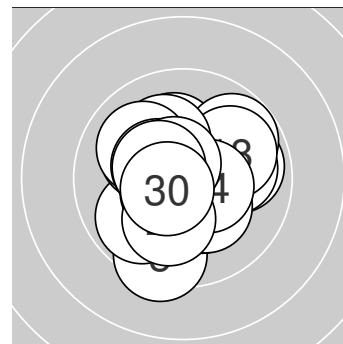

Serie 1:

10.2 *	10.5 *	9.9 →	10.3 *	9.4 ↓
9.9 ↙	10.5 *	10.5 *	10.8 *	10.3 *

beste Teiler: 44.0 (9.), 106.2 (8.), 106.3 (2.)
 Trefferlage: 0.13 mm links, 0.43 mm tief
 Streuwert: 1.48, horizontal: 1.20, vertikal: 1.72

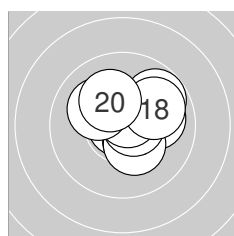

Serie 2:

10.8 *	10.4 *	10.0 →	10.3 *	10.6 *
9.8 ↗	10.7 *	9.9 ↗	10.1 ↘	10.2 *

beste Teiler: 27.0 (11.), 73.5 (17.), 79.0 (15.)
 Trefferlage: 0.68 mm rechts, 0.46 mm hoch
 Streuwert: 1.25, horizontal: 1.39, vertikal: 1.10

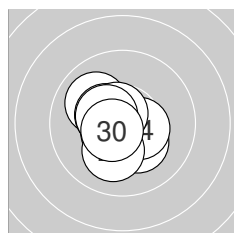

Serie 3:

10.6 *	10.3 *	10.5 *	10.5 *	10.0 ↘
10.4 *	10.1 ↓	10.6 *	10.4 *	10.6 *

beste Teiler: 81.6 (28.), 91.5 (30.), 100.7 (21.)
 Trefferlage: 0.57 mm links, 0.12 mm tief
 Streuwert: 1.01, horizontal: 0.98, vertikal: 1.04



Ergebnis: **309.5** (296)
 Serien: 104.8 100.9 103.8
 Zähler: 27 2 1 0 0 0 0 0 0 0
 Innenzehner: 24
 Weitester: 506 (12.), 379 (11.), 256 (21.)
 beste Teiler: 37.1 (4.), 50.0 (8.), 62.1 (6.)
 Trefferlage: 0.02 mm rechts, 0.26 mm tief
 Streuwert: 1.32, horizontal: 1.15, vertikal: 1.48

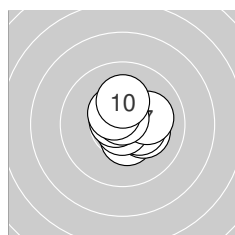
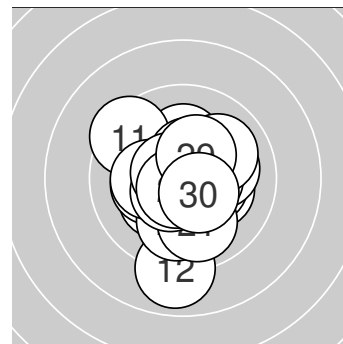

Serie 1:

10.4 *	10.2 *	10.4 *	10.8 *	10.7 *
10.7 *	10.1 ↗	10.8 *	10.5 *	10.2 *

beste Teiler: 37.1 (4.), 50.0 (8.), 62.1 (6.)
 Trefferlage: 0.44 mm rechts, 0.22 mm hoch
 Streuwert: 0.93, horizontal: 0.96, vertikal: 0.89

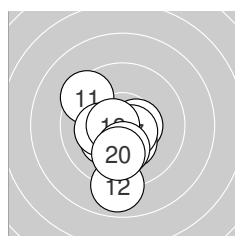

Serie 2:

9.4 ↘	8.9 ↓	10.2 *	10.5 *	10.2 *
10.3 *	10.6 *	10.6 *	10.2 *	10.0 ↓

beste Teiler: 82.0 (18.), 87.8 (17.), 114.0 (14.)
 Trefferlage: 0.52 mm links, 1.05 mm tief
 Streuwert: 1.63, horizontal: 1.27, vertikal: 1.92

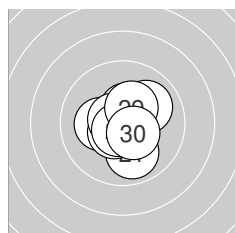

Serie 3:

9.9 ↓	10.2 *	10.5 *	10.5 *	10.0 ↗
10.5 *	10.6 *	10.7 *	10.4 *	10.5 *

beste Teiler: 67.1 (28.), 76.5 (27.), 103.2 (26.)
 Trefferlage: 0.15 mm rechts, 0.04 mm hoch
 Streuwert: 1.15, horizontal: 1.07, vertikal: 1.22



ISSF AR Mixed Quali – Wertung offene Klasse

StartNr: 73

StandNr: 127

2. November 2022 14:43

Entner, Patrick #210

TLSB / Tirol-NOE 1

Ergebnis: 311.5 (296)
Serien: 102.7 104.8 104.0
Zähler: 26 4 0 0 0 0 0 0 0 0
Innenzehner: 23
Weiteste: 309 (1.), 297 (29.), 277 (12.)
beste Teiler: 33.1 (17.), 39.3 (18.), 39.3 (24.)
Trefferlage: 0.30 mm rechts, 0.23 mm tief
Streuwert: 1.12, horizontal: 1.08, vertikal: 1.16

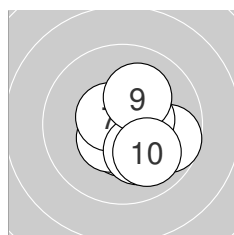
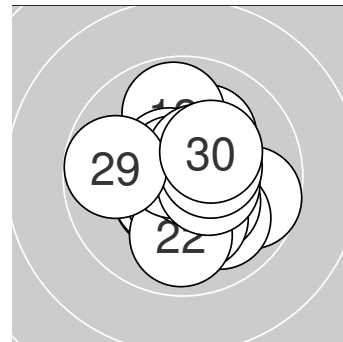

Serie 1:

9.7 ↗	10.5 *	10.5 *	10.1 ↘	10.5 *
10.5 *	10.6 *	10.2 *	10.1 ↗	10.0 ↘

beste Teiler: 96.7 (7.), 102.9 (2.), 119.0 (3.)
Trefferlage: 0.65 mm rechts, 0.65 mm tief
Streuwert: 1.18, horizontal: 1.20, vertikal: 1.16

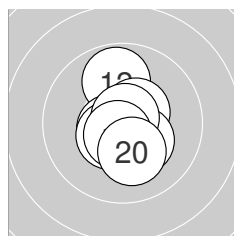

Serie 2:

10.7 *	9.8 ↑	10.5 *	10.6 *	10.5 *
10.3 *	10.8 *	10.8 *	10.6 *	10.2 *

beste Teiler: 33.1 (17.), 39.3 (18.), 60.7 (11.)
Trefferlage: 0.09 mm rechts, 0.17 mm tief
Streuwert: 1.01, horizontal: 0.68, vertikal: 1.25

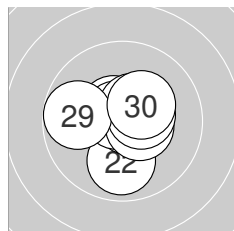

Serie 3:

10.6 *	9.9 ↓	10.5 *	10.8 *	10.7 *
10.5 *	10.5 *	10.4 *	9.8 ←	10.3 *

beste Teiler: 39.3 (24.), 55.1 (25.), 95.2 (21.)
Trefferlage: 0.16 mm rechts, 0.13 mm hoch
Streuwert: 1.17, horizontal: 1.28, vertikal: 1.04

