

ISSF AR Women – Wertung – Frauen

StartNr: 1

StandNr: 103

4. November 2022 9:54

Messner, Helena #150

T – SG Absam

Ergebnis: **614.8** (588)
 Serien: 100.1 103.6 101.7 102.6 103.1 103.7
 Zähler: 50 9 0 1 0 0 0 0 0
 Innenzehner: 40
 Weitester: 760 (1.), 379 (49.), 353 (35.)
 beste Teiler: 14.1 (50.), 30.6 (32.), 40.2 (59.)
 Trefferlage: 0.16 mm links, 0.24 mm hoch
 Streuwert: 1.48, horizontal: 1.67, vertikal: 1.27

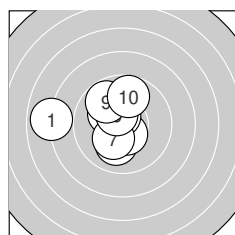
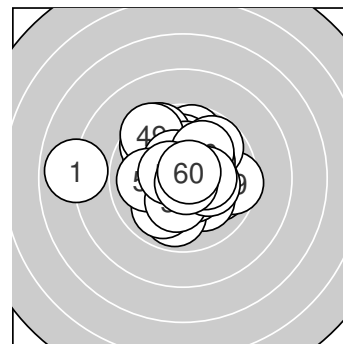

Serie 1:
 7.9 ← 10.6 * 10.1 ↓ 10.5 * 10.6 *
 10.2 * 10.2 * 10.5 * 9.8 ↘ 9.7 ↑
 beste Teiler: 86.6 (2.), 91.4 (5.), 113.0 (4.)
 Trefferlage: 1.25 mm links, 0.33 mm hoch
 Streuwert: 2.04, horizontal: 2.35, vertikal: 1.67

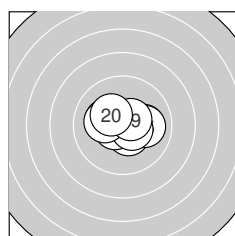

Serie 2:
 10.1 → 10.7 * 10.5 * 10.6 * 10.0 →
 10.2 * 10.5 * 10.2 * 10.5 * 10.3 *
 beste Teiler: 74.4 (12.), 88.6 (14.), 105.6 (19.)
 Trefferlage: 0.19 mm rechts, 0.11 mm hoch
 Streuwert: 1.17, horizontal: 1.54, vertikal: 0.62

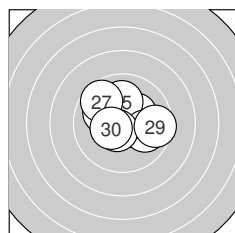

Serie 3:
 10.6 * 10.3 * 10.6 * 10.0 ↘ 10.0 ↑
 9.9 ↘ 9.7 ↘ 10.6 * 9.6 → 10.4 *
 beste Teiler: 76.2 (23.), 83.6 (21.), 98.4 (28.)
 Trefferlage: 0.16 mm rechts, 0.46 mm hoch
 Streuwert: 1.57, horizontal: 1.86, vertikal: 1.21

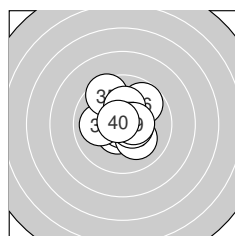

Serie 4:
 10.5 * 10.8 * 10.1 ↘ 10.0 ← 9.5 ↘
 9.8 ↗ 10.2 * 10.5 * 10.5 * 10.7 *
 beste Teiler: 30.6 (32.), 56.0 (40.), 106.6 (38.)
 Trefferlage: 0.06 mm rechts, 0.43 mm hoch
 Streuwert: 1.43, horizontal: 1.40, vertikal: 1.46

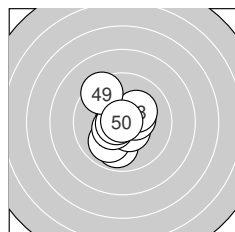

Serie 5:
 10.6 * 9.9 ↓ 10.0 ↗ 10.5 * 10.4 *
 10.5 * 10.7 * 10.2 * 9.4 ↘ 10.9 *
 beste Teiler: 14.1 (50.), 66.9 (47.), 99.6 (41.)
 Trefferlage: 0.31 mm links, 0.09 mm tief
 Streuwert: 1.42, horizontal: 1.18, vertikal: 1.62

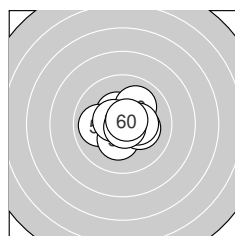

Serie 6:
 10.4 * 10.0 ← 10.3 * 10.5 * 10.2 *
 10.0 ↗ 10.3 * 10.5 * 10.8 * 10.7 *
 beste Teiler: 40.2 (59.), 61.5 (60.), 101.9 (58.)
 Trefferlage: 0.16 mm rechts, 0.20 mm hoch
 Streuwert: 1.15, horizontal: 1.33, vertikal: 0.94



Ergebnis: **621.6** (593)
 Serien: 103.2 105.2 102.0 104.2 103.9 103.1
 0.0
 Zähler: 53 7 0 0 0 0 0 0 0
 Innenzehner: 48
 Weitestе: 499 (58.), 289 (37.), 282 (3.)
 beste Teiler: 18.7 (16.), 24.1 (41.), 52.0 (60.)
 Trefferlage: 0.03 mm links, 0.15 mm tief
 Streuwert: 1.20, horizontal: 1.38, vertikal: 1.00

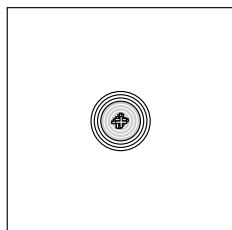
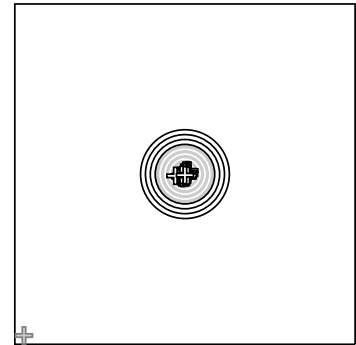

Serie 1:
 10.4 * 10.4 * 9.8 ↙ 10.3 * 10.4 *
 10.6 * 9.9 ↙ 10.3 * 10.5 * 10.6 *
 beste Teiler: 90.6 (6.), 95.7 (10.), 105.0 (9.)
 Trefferlage: 0.33 mm links, 0.12 mm hoch
 Streuwert: 1.24, horizontal: 1.40, vertikal: 1.05

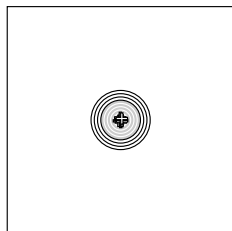

Serie 2:
 10.3 * 10.6 * 10.5 * 10.4 * 10.7 *
 10.9 * 10.3 * 10.4 * 10.7 * 10.4 *
 beste Teiler: 18.7 (16.), 59.3 (15.), 69.2 (19.)
 Trefferlage: 0.18 mm rechts, 0.16 mm hoch
 Streuwert: 0.87, horizontal: 0.75, vertikal: 0.99

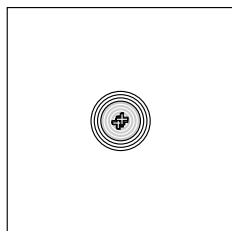

Serie 3:
 10.3 * 10.5 * 10.6 * 10.5 * 9.9 ↙
 9.9 ↙ 10.0 ↘ 10.0 ↘ 10.0 ↗ 10.3 *
 beste Teiler: 86.0 (23.), 118.6 (22.), 124.7 (24.)
 Trefferlage: 0.41 mm links, 0.24 mm tief
 Streuwert: 1.45, horizontal: 1.53, vertikal: 1.35

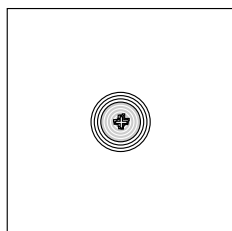

Serie 4:
 10.6 * 10.3 * 10.6 * 10.6 * 10.6 *
 10.4 * 9.8 ↗ 10.4 * 10.2 * 10.7 *
 beste Teiler: 61.9 (40.), 82.5 (31.), 88.4 (33.)
 Trefferlage: 0.55 mm rechts, 0.06 mm hoch
 Streuwert: 1.02, horizontal: 1.05, vertikal: 0.98

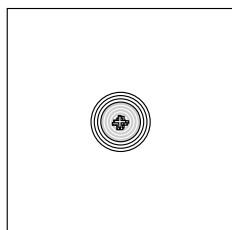

Serie 5:
 10.9 * 10.5 * 10.5 * 10.5 * 10.3 *
 10.2 * 9.9 ↙ 10.3 * 10.1 ↙ 10.7 *
 beste Teiler: 24.1 (41.), 57.5 (50.), 102.8 (42.)
 Trefferlage: 0.03 mm rechts, 0.63 mm tief
 Streuwert: 1.07, horizontal: 1.28, vertikal: 0.80

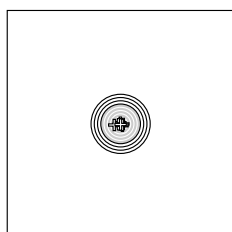

Serie 6:
 10.7 * 10.6 * 10.2 * 10.7 * 10.3 *
 10.5 * 10.1 → 9.0 ← 10.3 * 10.7 *
 beste Teiler: 52.0 (60.), 53.6 (51.), 74.4 (54.)
 Trefferlage: 0.22 mm links, 0.39 mm tief
 Streuwert: 1.49, horizontal: 2.01, vertikal: 0.64



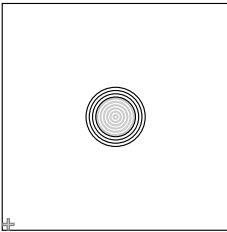

Serie 7:

0.0+ ↙

^{AST,NSC}

beste Teiler:

Trefferlage: 0.00 mm , 0.00 mm

Streuwert: 0.00, horizontal: 0.00, vertikal: 0.00

AST
NSC

- Treffer wurde nach Ende der Schießzeit abgegeben
- Treffer wurde vermessen, geht aber nicht in die Wertung ein



Ergebnis: **581.7** (556)
 Serien: 96.5 97.8 98.7 97.1 94.7 96.9
 Zähler: 23 32 4 0 1 0 0 0 0
 Innenzehner: 18
 Weitester: 1001 (39.), 603 (35.), 553 (46.)
 beste Teiler: 39.1 (4.), 43.0 (28.), 51.0 (22.)
 Trefferlage: 0.05 mm links, 0.27 mm tief
 Streuwert: 2.55, horizontal: 3.16, vertikal: 1.74

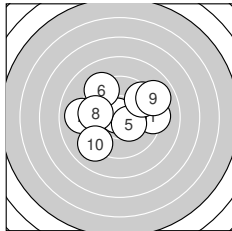
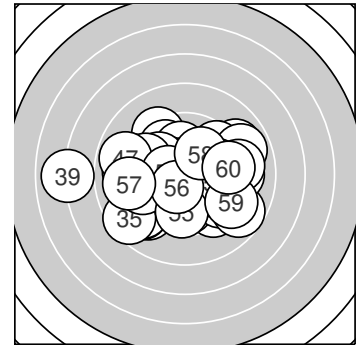

Serie 1:

9.2 →	9.0 ←	10.5 *	10.8 *	10.4 *
9.3 ↘	9.5 ↗	9.7 ←	9.0 ↗	9.1 ↘

beste Teiler: 39.1 (4.), 116.7 (3.), 144.7 (5.)
 Trefferlage: 0.01 mm rechts, 0.51 mm hoch
 Streuwert: 2.67, horizontal: 3.25, vertikal: 1.91

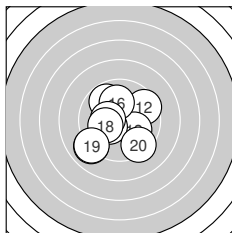

Serie 2:

9.0 ↙	9.5 ↗	10.1 ↘	10.4 *	9.8 ↘
10.0 ↑	10.4 *	10.2 *	9.0 ↙	9.4 ↘

beste Teiler: 150.3 (14.), 150.6 (17.), 193.5 (18.)
 Trefferlage: 0.64 mm links, 0.59 mm tief
 Streuwert: 2.30, horizontal: 2.38, vertikal: 2.21

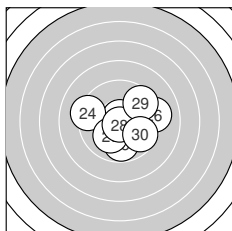

Serie 3:

10.0 ↓	10.7 *	9.6 →	9.3 ←	9.8 ↓
9.2 →	10.1 ↙	10.8 *	9.5 ↗	9.7 ↘

beste Teiler: 43.0 (28.), 51.0 (22.), 216.3 (27.)
 Trefferlage: 0.81 mm rechts, 0.40 mm tief
 Streuwert: 2.14, horizontal: 2.48, vertikal: 1.72

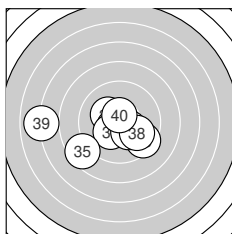

Serie 4:

10.2 *	10.4 *	10.6 *	10.3 *	8.5 ↙
9.4 ↘	10.3 *	9.9 ↘	6.9 ←	10.6 *

beste Teiler: 87.4 (33.), 89.0 (40.), 140.1 (32.)
 Trefferlage: 1.06 mm links, 0.95 mm tief
 Streuwert: 2.89, horizontal: 3.83, vertikal: 1.41

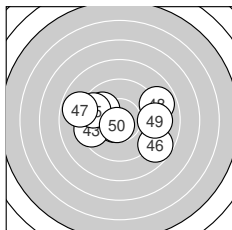

Serie 5:

10.6 *	9.0 ←	9.4 ←	9.9 ↘	9.5 ←
8.7 ↘	8.9 ←	8.9 ↗	9.1 →	10.7 *

beste Teiler: 71.5 (50.), 88.4 (41.), 258.4 (44.)
 Trefferlage: 0.61 mm links, 0.16 mm hoch
 Streuwert: 2.99, horizontal: 3.92, vertikal: 1.59



Serie 6:

10.4 *	9.8 →	9.9 →	9.1 →	9.7 ↓
10.4 *	9.0 ←	10.1 ↗	9.1 ↘	9.4 →

beste Teiler: 129.3 (56.), 145.1 (51.), 224.0 (58.)
 Trefferlage: 1.18 mm rechts, 0.40 mm tief
 Streuwert: 2.35, horizontal: 2.94, vertikal: 1.53



Ergebnis: **616.3** (589)
 Serien: 104.0 101.6 102.2 101.8 103.3 103.4
 Zähler: 49 11 0 0 0 0 0 0 0
 Innenzehner: 38
 Weitester: 406 (36.), 348 (12.), 339 (26.)
 beste Teiler: 24.7 (19.), 33.8 (39.), 36.0 (55.)
 Trefferlage: 0.12 mm rechts, 0.07 mm hoch
 Streuwert: 1.37, horizontal: 1.42, vertikal: 1.32

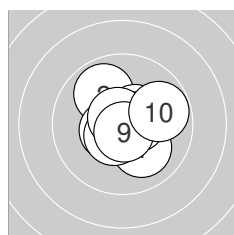
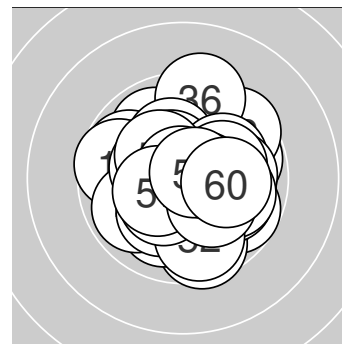

Serie 1:
 10.1 ↘ 9.9 ↘ 10.5 * 10.8 * 10.5 *
 10.5 * 10.5 * 10.7 * 10.7 * 9.8 →
 beste Teiler: 49.0 (4.), 57.8 (9.), 62.2 (8.)
 Trefferlage: 0.28 mm rechts, 0.05 mm hoch
 Streuwert: 1.18, horizontal: 1.25, vertikal: 1.12

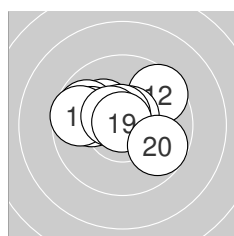

Serie 2:
 10.2 * 9.6 ↗ 9.8 ↖ 10.0 ↖ 9.7 ↖
 10.6 * 10.6 * 10.5 * 10.9 * 9.7 ↘
 beste Teiler: 24.7 (19.), 81.5 (17.), 84.0 (16.)
 Trefferlage: 0.49 mm links, 0.68 mm hoch
 Streuwert: 1.58, horizontal: 2.03, vertikal: 0.95

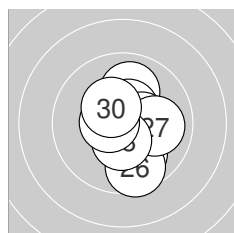

Serie 3:
 10.4 * 10.0 ↑ 9.9 ↘ 10.5 * 10.4 *
 9.6 ↘ 10.0 → 10.4 * 10.6 * 10.4 *
 beste Teiler: 99.1 (29.), 112.9 (24.), 128.2 (28.)
 Trefferlage: 0.63 mm rechts, 0.21 mm tief
 Streuwert: 1.39, horizontal: 1.06, vertikal: 1.66

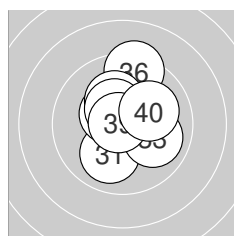

Serie 4:
 10.0 ↙ 10.2 * 10.0 ↘ 10.4 * 10.4 *
 9.3 ↑ 10.2 * 10.4 * 10.8 * 10.1 →
 beste Teiler: 33.8 (39.), 126.2 (35.), 128.8 (38.)
 Trefferlage: 0.19 mm rechts, 0.87 mm hoch
 Streuwert: 1.44, horizontal: 1.17, vertikal: 1.66

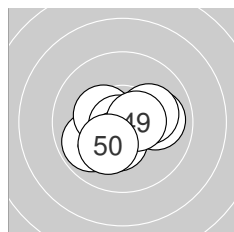

Serie 5:
 10.0 → 10.4 * 9.9 ↙ 10.7 * 10.3 *
 10.1 → 10.8 * 10.4 * 10.5 * 10.2 *
 beste Teiler: 37.8 (47.), 60.0 (44.), 102.2 (49.)
 Trefferlage: 0.19 mm links, 0.40 mm tief
 Streuwert: 1.24, horizontal: 1.54, vertikal: 0.85

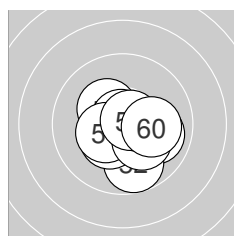

Serie 6:
 10.0 ↘ 9.8 ↘ 10.3 * 10.7 * 10.8 *
 10.4 * 10.4 * 10.2 * 10.7 * 10.1 →
 beste Teiler: 36.0 (55.), 63.0 (54.), 64.4 (59.)
 Trefferlage: 0.33 mm rechts, 0.54 mm tief
 Streuwert: 1.22, horizontal: 1.35, vertikal: 1.09



Ergebnis: **623.7** (595)
 Serien: 103.7 103.2 104.3 104.7^{OF} 102.9 104.9
 Zähler: 55 5 0 0 0 0 0 0 0
 Innenzehner: 48
 Weitestе: 439 (42.), 340 (15.), 276 (56.)
 beste Teiler: 14.3 (28.), 17.0 (17.), 18.9 (45.)
 Trefferlage: 0.04 mm links, 0.00 mm
 Streuwert: 1.15, horizontal: 1.16, vertikal: 1.14

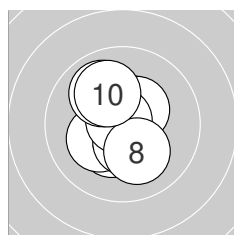
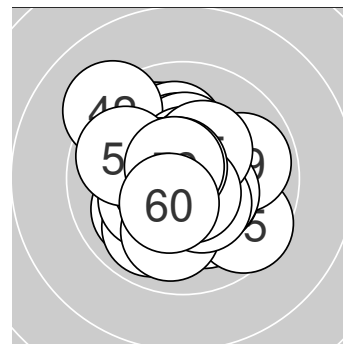

Serie 1:

10.3 *	10.9 *	10.2 *	10.5 *	10.4 *
10.5 *	10.8 *	10.1 ↘	10.0 ↘	10.0 ↘

beste Teiler: 25.2 (2.), 35.3 (7.), 119.7 (4.)
 Trefferlage: 0.23 mm links, 0.08 mm hoch
 Streuwert: 1.20, horizontal: 0.92, vertikal: 1.42

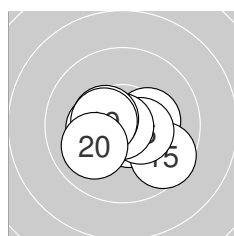

Serie 2:

10.3 *	10.1 ↘	10.3 *	10.7 *	9.6 ↘
10.4 *	10.9 *	10.5 *	10.4 *	10.0 ↘

beste Teiler: 17.0 (17.), 75.2 (14.), 125.0 (18.)
 Trefferlage: 0.18 mm rechts, 0.46 mm tief
 Streuwert: 1.29, horizontal: 1.63, vertikal: 0.80

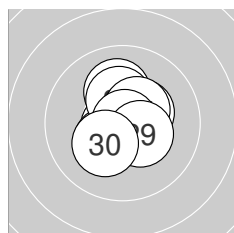

Serie 3:

10.7 *	10.1 ↑	10.3 *	10.6 *	10.3 *
10.4 *	10.4 *	10.9 *	10.4 *	10.2 *

beste Teiler: 14.3 (28.), 61.0 (21.), 90.6 (24.)
 Trefferlage: 0.02 mm rechts, 0.28 mm hoch
 Streuwert: 1.03, horizontal: 0.88, vertikal: 1.16

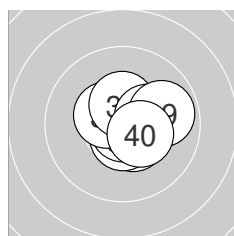

Serie 4:

10.5 *	10.6 *	10.8 *	10.7 *	10.6 *
10.5 *	10.4 *	10.3 *	9.9 →	10.4 *

beste Teiler: 31.4 (33.), 61.0 (34.), 85.7 (35.)
 Trefferlage: 0.66 mm rechts, 0.01 mm hoch
 Streuwert: 0.90, horizontal: 1.03, vertikal: 0.75

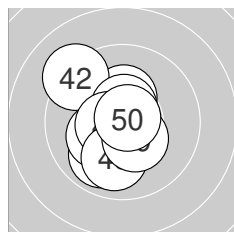

Serie 5:

10.3 *	9.2 ↘	10.6 *	9.9 ↘	10.9 *
10.2 *	10.6 *	10.0 ↓	10.4 *	10.8 *

beste Teiler: 18.9 (45.), 43.2 (50.), 98.4 (43.)
 Trefferlage: 0.64 mm links, 0.11 mm tief
 Streuwert: 1.45, horizontal: 1.18, vertikal: 1.68

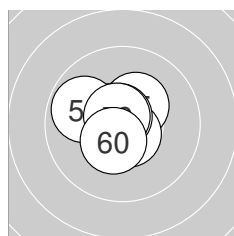

Serie 6:

10.5 *	10.5 *	10.7 *	10.7 *	10.3 *
9.8 ↘	10.6 *	10.7 *	10.7 *	10.4 *

beste Teiler: 53.2 (54.), 55.9 (58.), 65.0 (59.)
 Trefferlage: 0.28 mm links, 0.25 mm hoch
 Streuwert: 0.90, horizontal: 0.97, vertikal: 0.81



ISSF AR Women – Wertung – Frauen

StandNr: 107

Ungerank, Nadine #172

StartNr: 5

4. November 2022 10:10

AUT

QF

– Schütze hat sich fürs Finale qualifiziert



Ergebnis: **613.0** (584)
 Serien: 104.4 103.5 99.5 100.8 100.6 104.2
 Zähler: 44 16 0 0 0 0 0 0 0
 Innenzehner: 39
 Weitestе: 403 (31.), 360 (39.), 357 (30.)
 beste Teiler: 10.2 (52.), 38.0 (2.), 43.9 (15.)
 Trefferlage: 0.26 mm links, 0.18 mm hoch
 Streuwert: 1.48, horizontal: 1.64, vertikal: 1.29

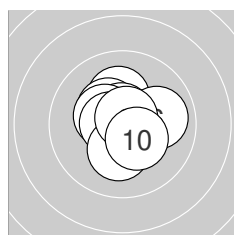
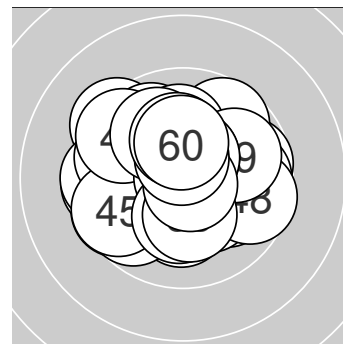

Serie 1:

10.2 *	10.8 *	10.4 *	10.7 *	10.4 *
10.0 →	10.6 *	10.2 *	10.7 *	10.4 *

beste Teiler: 38.0 (2.), 52.8 (9.), 71.5 (4.)
 Trefferlage: 0.03 mm links, 0.21 mm hoch
 Streuwert: 1.07, horizontal: 1.08, vertikal: 1.05

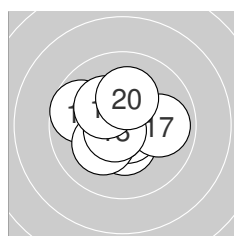

Serie 2:

9.7 ↖	10.4 *	10.7 *	10.7 *	10.8 *
10.2 *	9.9 →	10.7 *	10.2 *	10.2 *

beste Teiler: 43.9 (15.), 58.6 (13.), 66.2 (14.)
 Trefferlage: 0.31 mm links, 0.07 mm hoch
 Streuwert: 1.27, horizontal: 1.44, vertikal: 1.08

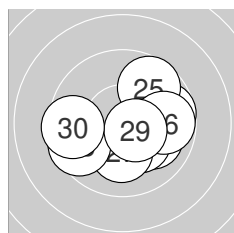

Serie 3:

10.3 *	9.7 →	10.0 ↘	10.2 *	9.7 ↗
9.8 →	10.2 *	9.6 ↙	10.5 *	9.5 ←

beste Teiler: 105.1 (29.), 167.6 (21.), 176.9 (24.)
 Trefferlage: 0.63 mm rechts, 0.47 mm tief
 Streuwert: 1.87, horizontal: 2.28, vertikal: 1.32

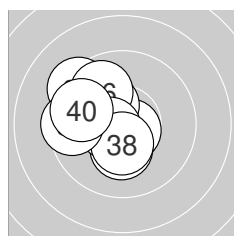

Serie 4:

9.3 ↘	10.1 ↖	10.7 *	10.3 *	10.3 *
9.9 ↘	10.6 *	10.4 *	9.5 ←	9.7 ↖

beste Teiler: 66.6 (33.), 96.4 (37.), 138.0 (38.)
 Trefferlage: 1.47 mm links, 0.40 mm hoch
 Streuwert: 1.43, horizontal: 1.41, vertikal: 1.44

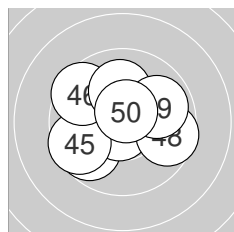

Serie 5:

10.4 *	9.7 ↙	10.7 *	10.4 *	9.6 ↙
9.6 ↘	10.1 ↑	9.6 →	9.9 →	10.6 *

beste Teiler: 56.8 (43.), 80.9 (50.), 133.0 (44.)
 Trefferlage: 0.34 mm links, 0.39 mm hoch
 Streuwert: 1.80, horizontal: 2.07, vertikal: 1.48

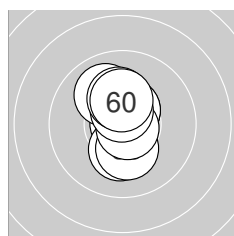

Serie 6:

10.5 *	10.9 *	10.0 ↘	10.2 *	10.2 *
10.5 *	10.8 *	10.6 *	10.2 *	10.3 *

beste Teiler: 10.2 (52.), 45.4 (57.), 96.1 (58.)
 Trefferlage: 0.03 mm links, 0.47 mm hoch
 Streuwert: 1.05, horizontal: 0.50, vertikal: 1.39



Ergebnis: **611.4** (587)
 Serien: 100.6 101.3 103.1 102.2 102.5 101.7
 Zähler: 47 13 0 0 0 0 0 0 0
 Innenzehner: 34
 Weitestе: 468 (57.), 426 (10.), 401 (36.)
 beste Teiler: 22.4 (47.), 36.6 (2.), 37.2 (37.)
 Trefferlage: 0.24 mm links, 0.11 mm tief
 Streuwert: 1.51, horizontal: 1.45, vertikal: 1.56

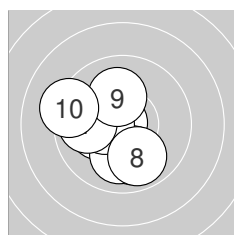
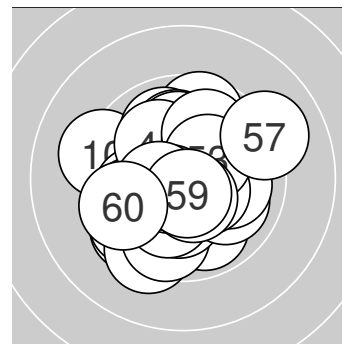

Serie 1:
 10.1 ↓ 10.8 * 10.0 ↓ 10.2 * 10.0 ↓
 10.4 * 9.9 ← 9.9 ↓ 10.1 ↑ 9.2 ←
 beste Teiler: 36.6 (2.), 135.0 (6.), 186.0 (4.)
 Trefferlage: 0.92 mm links, 0.61 mm tief
 Streuwert: 1.59, horizontal: 1.58, vertikal: 1.61

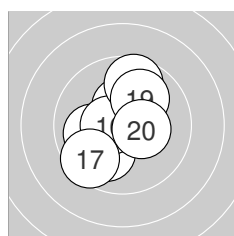

Serie 2:
 10.0 ↙ 10.4 * 10.2 * 10.6 * 10.0 ←
 10.6 * 9.5 ↘ 9.6 ↑ 10.0 ↗ 10.4 *
 beste Teiler: 95.0 (14.), 99.0 (16.), 141.4 (12.)
 Trefferlage: 0.15 mm links, 0.26 mm hoch
 Streuwert: 1.65, horizontal: 1.50, vertikal: 1.79

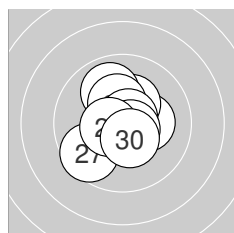

Serie 3:
 10.2 * 10.3 * 10.6 * 9.9 ↖ 10.3 *
 10.7 * 9.6 ↗ 10.6 * 10.5 * 10.4 *
 beste Teiler: 56.7 (26.), 77.0 (28.), 82.0 (23.)
 Trefferlage: 0.17 mm links, 0.15 mm hoch
 Streuwert: 1.29, horizontal: 1.22, vertikal: 1.36

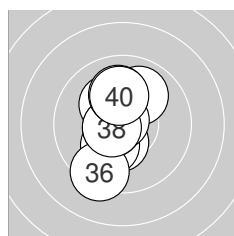

Serie 4:
 10.0 ↗ 10.2 * 10.4 * 10.2 * 10.6 *
 9.3 ↓ 10.8 * 10.6 * 10.0 ↑ 10.1 ↑
 beste Teiler: 37.2 (37.), 85.0 (35.), 85.7 (38.)
 Trefferlage: 0.52 mm links, 0.12 mm hoch
 Streuwert: 1.49, horizontal: 0.78, vertikal: 1.95

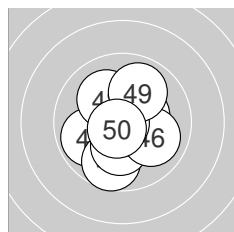

Serie 5:
 10.4 * 9.9 ← 9.7 ↓ 10.7 * 10.2 *
 10.0 ↘ 10.9 * 10.1 ↖ 9.9 ↗ 10.7 *
 beste Teiler: 22.4 (47.), 52.8 (44.), 66.6 (50.)
 Trefferlage: 0.09 mm links, 0.26 mm tief
 Streuwert: 1.48, horizontal: 1.35, vertikal: 1.60

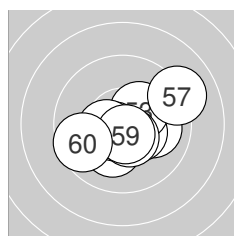

Serie 6:
 10.0 → 10.4 * 10.3 * 10.2 * 10.6 *
 10.5 * 9.1 ↗ 10.4 * 10.6 * 9.6 ←
 beste Teiler: 81.0 (59.), 86.6 (55.), 114.9 (56.)
 Trefferlage: 0.39 mm rechts, 0.37 mm tief
 Streuwert: 1.63, horizontal: 2.00, vertikal: 1.16



Ergebnis: **613.0** (584)
 Serien: 101.8 101.8 101.3 102.3 102.7 103.1
 Zähler: 44 16 0 0 0 0 0 0 0
 Innenzehner: 35
 Weitestе: 401 (19.), 388 (25.), 367 (33.)
 beste Teiler: 11.4 (4.), 17.0 (51.), 39.8 (16.)
 Trefferlage: 0.13 mm links, 0.71 mm hoch
 Streuwert: 1.40, horizontal: 1.64, vertikal: 1.11

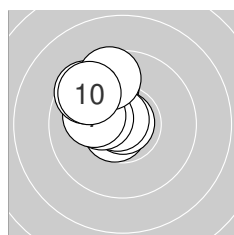
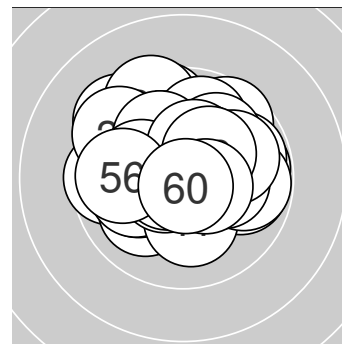

Serie 1:
 9.8 ↘ 10.7 * 10.3 * 10.9 * 10.8 *
 10.3 * 10.1 ← 9.6 ↘ 9.6 ↑ 9.7 ↘
 beste Teiler: 11.4 (4.), 48.8 (5.), 70.4 (2.)
 Trefferlage: 1.26 mm links, 1.22 mm hoch
 Streuwert: 1.08, horizontal: 0.87, vertikal: 1.26

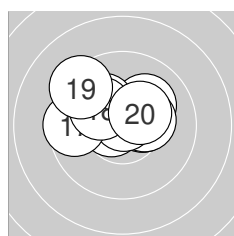

Serie 2:
 10.4 * 10.6 * 10.1 ↗ 10.3 * 10.2 *
 10.8 * 9.6 ← 10.2 * 9.3 ↘ 10.3 *
 beste Teiler: 39.8 (16.), 79.0 (12.), 145.5 (11.)
 Trefferlage: 0.42 mm links, 0.87 mm hoch
 Streuwert: 1.46, horizontal: 1.89, vertikal: 0.84

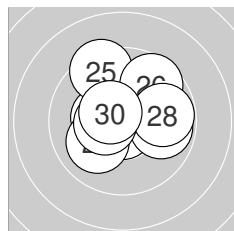

Serie 3:
 10.8 * 10.5 * 9.8 → 10.4 * 9.4 ↘
 9.6 ↗ 10.0 ↙ 9.8 → 10.5 * 10.5 *
 beste Teiler: 48.0 (21.), 104.6 (22.), 107.4 (30.)
 Trefferlage: 0.00 mm , 0.56 mm hoch
 Streuwert: 1.67, horizontal: 1.83, vertikal: 1.49

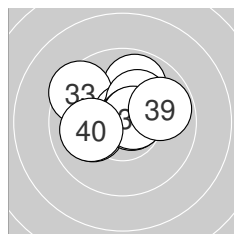

Serie 4:
 9.9 ↑ 10.1 ← 9.5 ↘ 10.8 * 10.7 *
 10.2 * 10.7 * 10.6 * 9.8 → 10.0 ←
 beste Teiler: 48.7 (34.), 68.3 (37.), 74.6 (35.)
 Trefferlage: 0.06 mm links, 0.74 mm hoch
 Streuwert: 1.46, horizontal: 1.79, vertikal: 1.05

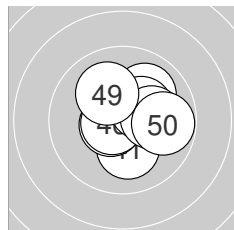

Serie 5:
 10.2 * 10.4 * 10.5 * 10.6 * 10.0 ↗
 10.7 * 10.3 * 10.1 → 10.1 ↘ 9.8 →
 beste Teiler: 75.9 (46.), 91.5 (44.), 115.6 (43.)
 Trefferlage: 0.63 mm rechts, 0.43 mm hoch
 Streuwert: 1.25, horizontal: 1.33, vertikal: 1.18

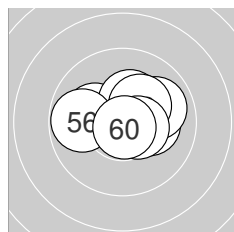

Serie 6:
 10.9 * 10.3 * 10.1 ← 10.3 * 10.2 *
 9.8 ← 9.9 → 10.3 * 10.5 * 10.8 *
 beste Teiler: 17.0 (51.), 40.1 (60.), 113.8 (59.)
 Trefferlage: 0.33 mm rechts, 0.44 mm hoch
 Streuwert: 1.26, horizontal: 1.63, vertikal: 0.73



Ergebnis: **616.7** (591)
 Serien: 102.2 102.4 102.4 103.0 104.4 102.3
 0.0
 Zähler: 51 9 0 0 0 0 0 0 0
 Innenzehner: 39
 Weitester: 493 (18.), 372 (7.), 339 (36.)
 beste Teiler: 35.1 (50.), 36.0 (16.), 36.7 (14.)
 Trefferlage: 0.13 mm rechts, 0.09 mm hoch
 Streuwert: 1.35, horizontal: 1.54, vertikal: 1.14

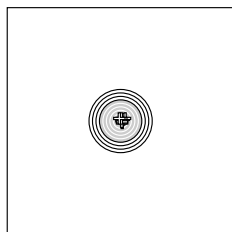
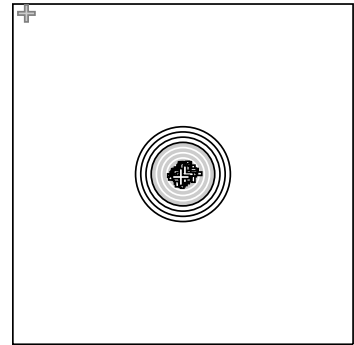

Serie 1:

10.1 ↗	10.2 *	10.5 *	10.6 *	10.6 *
9.9 ↗	9.5 ↗	10.5 *	10.2 *	10.1 ↘

beste Teiler: 96.6 (4.), 99.9 (5.), 105.4 (3.)
 Trefferlage: 1.12 mm rechts, 0.73 mm hoch
 Streuwert: 1.11, horizontal: 1.10, vertikal: 1.11

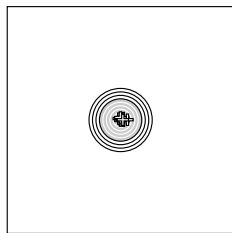

Serie 2:

10.1 →	10.3 *	10.4 *	10.8 *	10.0 ↗
10.8 *	10.5 *	9.0 →	10.2 *	10.3 *

beste Teiler: 36.0 (16.), 36.7 (14.), 118.5 (17.)
 Trefferlage: 1.06 mm rechts, 0.53 mm hoch
 Streuwert: 1.36, horizontal: 1.74, vertikal: 0.81

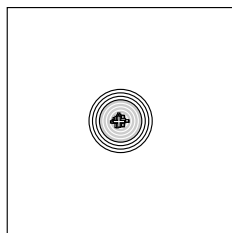

Serie 3:

10.1 ↘	10.1 →	10.3 *	10.1 ←	10.7 *
10.5 *	9.6 ←	10.0 ←	10.6 *	10.4 *

beste Teiler: 54.2 (25.), 82.4 (29.), 103.2 (26.)
 Trefferlage: 0.82 mm links, 0.03 mm hoch
 Streuwert: 1.28, horizontal: 1.64, vertikal: 0.77

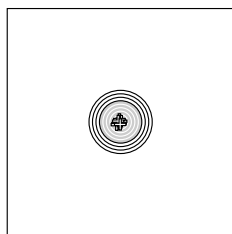

Serie 4:

10.3 *	10.7 *	9.9 ↙	10.5 *	10.8 *
9.6 ↙	10.7 *	10.1 ↘	10.2 *	10.2 *

beste Teiler: 38.0 (35.), 63.0 (32.), 74.4 (37.)
 Trefferlage: 0.86 mm links, 0.26 mm tief
 Streuwert: 1.19, horizontal: 1.06, vertikal: 1.31

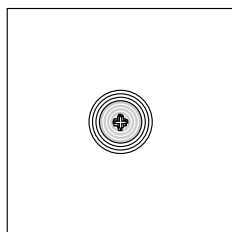

Serie 5:

10.6 *	10.2 *	10.4 *	10.5 *	10.5 *
10.3 *	10.1 ↓	10.5 *	10.5 *	10.8 *

beste Teiler: 35.1 (50.), 85.7 (41.), 109.4 (45.)
 Trefferlage: 0.20 mm links, 0.18 mm tief
 Streuwert: 0.98, horizontal: 0.85, vertikal: 1.10

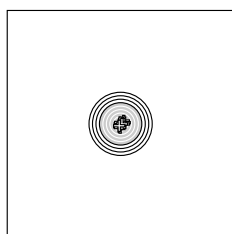

Serie 6:

9.7 ↗	9.8 →	10.7 *	10.8 *	10.0 ↘
10.0 →	10.5 *	9.9 ↓	10.6 *	10.3 *

beste Teiler: 37.0 (54.), 66.4 (53.), 95.0 (59.)
 Trefferlage: 0.49 mm rechts, 0.27 mm tief
 Streuwert: 1.46, horizontal: 1.48, vertikal: 1.43



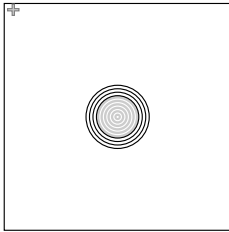

Serie 7:

0.0+ ^{AST,NSC}

beste Teiler:

Trefferlage: 0.00 mm , 0.00 mm

Streuwert: 0.00, horizontal: 0.00, vertikal: 0.00

AST
NSC

- Treffer wurde nach Ende der Schießzeit abgegeben
- Treffer wurde vermessen, geht aber nicht in die Wertung ein



Ergebnis: **625.9** (598)
 Serien: 103.6 103.4 103.8 106.2^{OF} 105.2 103.7
 Zähler: 58 2 0 0 0 0 0 0 0
 Innenzehner: 46
 Weitest: 258 (5.), 251 (25.), 250 (11.)
 beste Teiler: 17.0 (57.), 18.0 (35.), 43.8 (4.)
 Trefferlage: 0.35 mm rechts, 0.08 mm tief
 Streuwert: 1.01, horizontal: 1.05, vertikal: 0.97

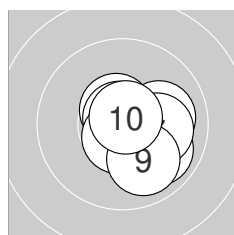
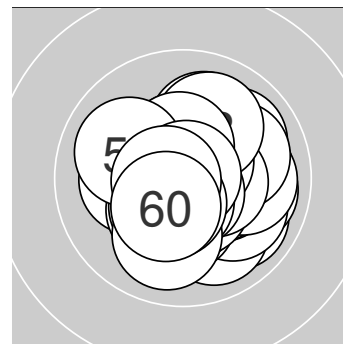

Serie 1:

10.6 *	10.2 *	10.6 *	10.8 *	9.9 ↘
10.0 →	10.1 →	10.6 *	10.0 ↘	10.8 *

beste Teiler: 43.8 (4.), 46.0 (10.), 82.2 (8.)
 Trefferlage: 0.89 mm rechts, 0.42 mm tief
 Streuwert: 1.03, horizontal: 1.09, vertikal: 0.96

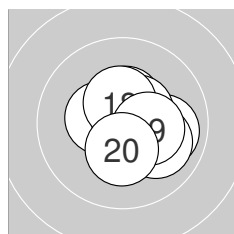

Serie 2:

10.0 →	10.6 *	10.5 *	10.0 ↘	10.4 *
10.4 *	10.5 *	10.4 *	10.3 *	10.3 *

beste Teiler: 89.4 (12.), 113.7 (17.), 118.0 (13.)
 Trefferlage: 0.66 mm rechts, 0.07 mm tief
 Streuwert: 1.08, horizontal: 1.13, vertikal: 1.02

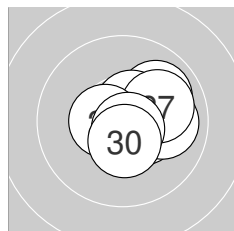

Serie 3:

10.4 *	10.7 *	10.6 *	10.0 →	9.9 ↗
10.5 *	10.0 →	10.5 *	10.7 *	10.5 *

beste Teiler: 58.2 (29.), 62.6 (22.), 89.9 (23.)
 Trefferlage: 0.76 mm rechts, 0.03 mm hoch
 Streuwert: 1.02, horizontal: 1.18, vertikal: 0.84

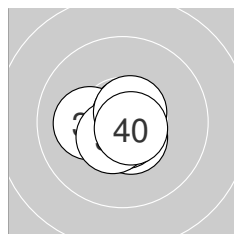

Serie 4:

10.7 *	10.7 *	10.5 *	10.7 *	10.9 *
10.1 ←	10.7 *	10.5 *	10.7 *	10.7 *

beste Teiler: 18.0 (35.), 53.0 (37.), 54.3 (31.)
 Trefferlage: 0.02 mm links, 0.20 mm tief
 Streuwert: 0.68, horizontal: 0.78, vertikal: 0.56

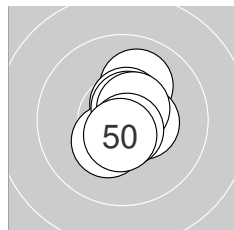

Serie 5:

10.0 ↗	10.5 *	10.8 *	10.6 *	10.3 *
10.5 *	10.6 *	10.6 *	10.7 *	10.6 *

beste Teiler: 48.4 (43.), 65.7 (49.), 81.1 (47.)
 Trefferlage: 0.37 mm rechts, 0.20 mm hoch
 Streuwert: 0.83, horizontal: 0.60, vertikal: 1.01

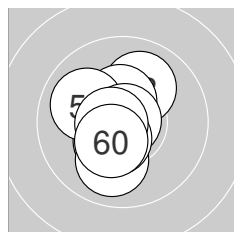

Serie 6:

10.4 *	10.4 *	10.0 ↗	10.4 *	10.0 ↓
10.0 ↘	10.9 *	10.5 *	10.7 *	10.4 *

beste Teiler: 17.0 (57.), 69.8 (59.), 111.8 (58.)
 Trefferlage: 0.54 mm links, 0.04 mm tief
 Streuwert: 1.13, horizontal: 0.83, vertikal: 1.37



ISSF AR Women – Wertung – Frauen

StandNr: 113

Waibel, Sheileen #170

StartNr: 11

4. November 2022 9:51

AUT

QF

– Schütze hat sich fürs Finale qualifiziert



Ergebnis: **598.3** (572)
 Serien: 99.3 100.4 100.9 98.0 100.5 99.2
 0.0
 Zähler: 36 20 4 0 0 0 0 0 0
 Innenzehner: 27
 Weitester: 668 (31.), 652 (21.), 638 (19.)
 beste Teiler: 29.7 (41.), 40.7 (30.), 47.3 (16.)
 Trefferlage: 0.03 mm links, 0.20 mm hoch
 Streuwert: 2.06, horizontal: 2.42, vertikal: 1.62

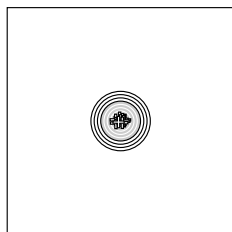
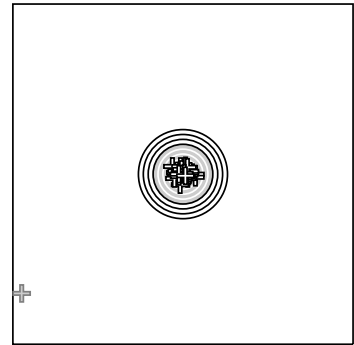

Serie 1:
 9.9 ↗ 9.4 ← 9.4 ← 9.6 → 10.7 *
 10.1 ↗ 9.8 → 10.0 → 10.2 * 10.2 *
 beste Teiler: 51.2 (5.), 177.0 (10.), 181.7 (9.)
 Trefferlage: 0.15 mm rechts, 0.24 mm hoch
 Streuwert: 2.01, horizontal: 2.55, vertikal: 1.26

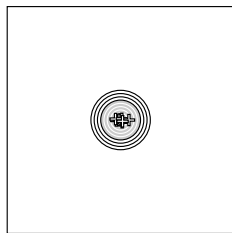

Serie 2:
 10.5 * 10.7 * 9.6 ← 10.3 * 10.1 ↘
 10.8 * 9.4 ← 10.4 * 8.4 → 10.2 *
 beste Teiler: 47.3 (16.), 53.2 (12.), 109.2 (11.)
 Trefferlage: 0.05 mm links, 0.09 mm tief
 Streuwert: 2.11, horizontal: 2.88, vertikal: 0.80

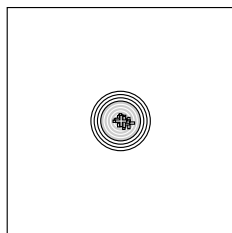

Serie 3:
 8.3 → 10.6 * 9.7 → 10.6 * 9.6 ↘
 10.4 * 10.6 * 10.5 * 9.8 → 10.8 *
 beste Teiler: 40.7 (30.), 80.9 (27.), 89.5 (24.)
 Trefferlage: 1.45 mm rechts, 0.23 mm tief
 Streuwert: 1.76, horizontal: 2.26, vertikal: 1.05

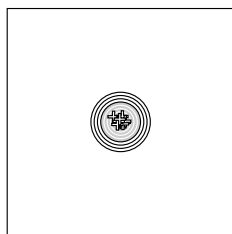

Serie 4:
 8.3 ↘ 10.4 * 9.7 → 10.7 * 9.2 ↑
 9.5 → 10.0 ↘ 10.4 * 9.7 ↙ 10.1 ↑
 beste Teiler: 72.4 (34.), 135.7 (32.), 150.4 (38.)
 Trefferlage: 0.18 mm links, 0.66 mm hoch
 Streuwert: 2.44, horizontal: 2.72, vertikal: 2.13

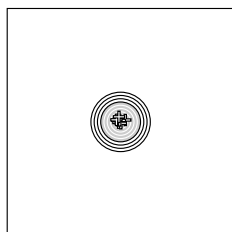

Serie 5:
 10.8 * 10.4 * 10.1 ↘ 10.3 * 9.4 →
 9.8 ↘ 10.5 * 10.4 * 9.5 ↘ 9.3 ↑
 beste Teiler: 29.7 (41.), 106.2 (47.), 129.8 (48.)
 Trefferlage: 0.83 mm links, 0.88 mm hoch
 Streuwert: 1.67, horizontal: 1.86, vertikal: 1.46

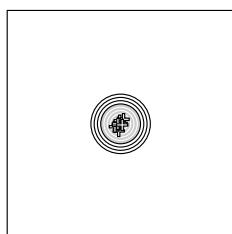

Serie 6:
 10.3 * 10.7 * 8.7 ↓ 9.0 ← 10.0 ←
 10.0 ↑ 9.3 ↗ 10.7 * 10.1 ← 10.4 *
 beste Teiler: 73.0 (52.), 73.0 (58.), 147.5 (60.)
 Trefferlage: 0.71 mm links, 0.25 mm tief
 Streuwert: 2.21, horizontal: 1.95, vertikal: 2.44



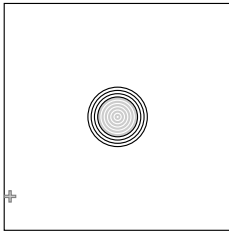

Serie 7:

0.0+ ↙

^{AST,NSC}

beste Teiler:

Trefferlage: 0.00 mm , 0.00 mm

Streuwert: 0.00, horizontal: 0.00, vertikal: 0.00

AST
NSC

- Treffer wurde nach Ende der Schießzeit abgegeben
- Treffer wurde vermessen, geht aber nicht in die Wertung ein



Ergebnis: **630.8** (598)
 Serien: 105.7 105.5 103.6 104.9^{OF} 106.1 105.0
 Zähler: 58 2 0 0 0 0 0 0 0
 Innenzehner: 53
 Weitestе: 300 (35.), 256 (25.), 247 (26.)
 beste Teiler: 11.1 (9.), 29.0 (39.), 29.2 (27.)
 Trefferlage: 0.06 mm links, 0.07 mm tief
 Streuwert: 0.89, horizontal: 0.92, vertikal: 0.86

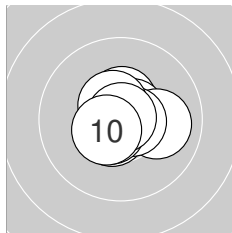
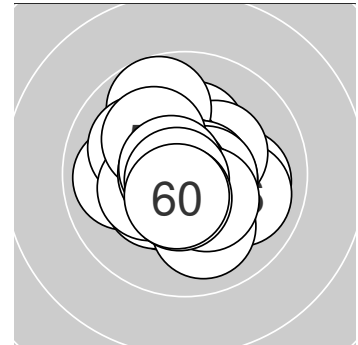

Serie 1:

10.5 *	10.6 *	10.0 →	10.6 *	10.8 *
10.7 *	10.5 *	10.6 *	10.9 *	10.5 *

beste Teiler: 11.1 (9.), 33.6 (5.), 71.3 (6.)
 Trefferlage: 0.09 mm rechts, 0.02 mm tief
 Streuwert: 0.81, horizontal: 0.95, vertikal: 0.66

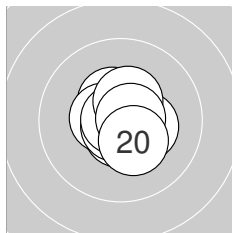

Serie 2:

10.3 *	10.6 *	10.4 *	10.8 *	10.5 *
10.7 *	10.8 *	10.4 *	10.7 *	10.3 *

beste Teiler: 32.2 (17.), 48.0 (14.), 52.0 (16.)
 Trefferlage: 0.10 mm rechts, 0.06 mm tief
 Streuwert: 0.77, horizontal: 0.74, vertikal: 0.80

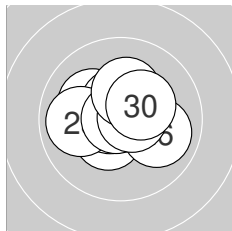

Serie 3:

10.4 *	10.1 ↘	10.7 *	10.5 *	9.9 ←
10.0 →	10.8 *	10.7 *	10.2 *	10.3 *

beste Teiler: 29.2 (27.), 69.0 (23.), 74.9 (28.)
 Trefferlage: 0.17 mm links, 0.27 mm hoch
 Streuwert: 1.19, horizontal: 1.44, vertikal: 0.87

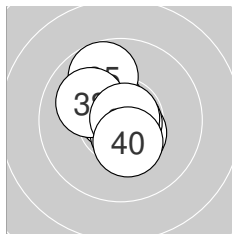

Serie 4:

10.5 *	10.7 *	10.5 *	10.7 *	9.8 ↗
10.8 *	10.6 *	10.1 ↘	10.8 *	10.4 *

beste Teiler: 29.0 (39.), 45.6 (36.), 52.2 (32.)
 Trefferlage: 0.16 mm links, 0.18 mm hoch
 Streuwert: 1.05, horizontal: 0.86, vertikal: 1.21

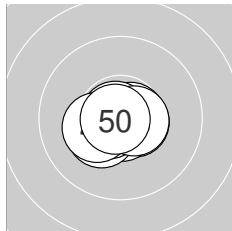

Serie 5:

10.7 *	10.6 *	10.7 *	10.8 *	10.7 *
10.3 *	10.6 *	10.6 *	10.3 *	10.8 *

beste Teiler: 35.1 (44.), 35.6 (50.), 53.4 (45.)
 Trefferlage: 0.11 mm links, 0.30 mm tief
 Streuwert: 0.65, horizontal: 0.86, vertikal: 0.32

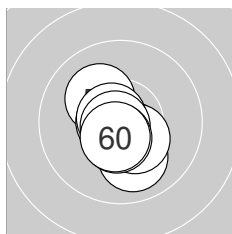

Serie 6:

10.7 *	10.5 *	10.2 *	10.0 ↓	10.7 *
10.4 *	10.7 *	10.8 *	10.5 *	10.5 *

beste Teiler: 43.0 (58.), 63.0 (55.), 64.4 (57.)
 Trefferlage: 0.15 mm links, 0.53 mm tief
 Streuwert: 0.86, horizontal: 0.71, vertikal: 0.99



ISSF AR Women – Wertung – Frauen

StandNr: 115

Brabcova, Aneta #70507093

StartNr: 13

4. November 2022 9:49

CZE

QF

– Schütze hat sich fürs Finale qualifiziert



Ergebnis: **614.4** (586)
 Serien: 104.2 101.2 102.4 100.2 103.9 102.5
 Zähler: 46 14 0 0 0 0 0 0 0
 Innenzehner: 41
 Weitestе: 484 (15.), 427 (22.), 422 (39.)
 beste Teiler: 25.6 (45.), 34.0 (10.), 34.6 (21.)
 Trefferlage: 0.06 mm links, 0.06 mm tief
 Streuwert: 1.47, horizontal: 1.62, vertikal: 1.30

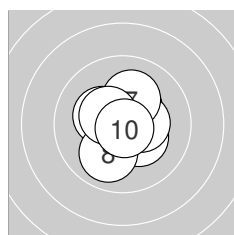
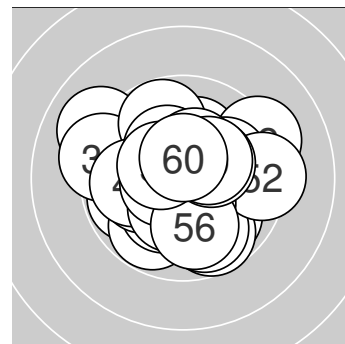

Serie 1:
 10.4 * 10.8 * 10.3 * 10.7 * 10.3 *
 10.4 * 10.1 ↑ 10.0 ↘ 10.4 * 10.8 *
 beste Teiler: 34.0 (10.), 37.5 (2.), 68.9 (4.)
 Trefferlage: 0.00 mm , 0.19 mm hoch
 Streuwert: 1.10, horizontal: 1.04, vertikal: 1.15

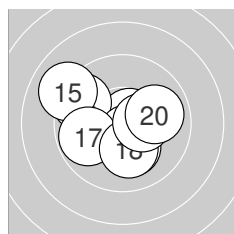

Serie 2:
 10.2 * 10.8 * 10.7 * 9.6 ↘ 9.0 ↘
 10.6 * 9.8 ← 10.2 * 10.4 * 9.9 →
 beste Teiler: 46.0 (12.), 67.6 (13.), 91.7 (16.)
 Trefferlage: 0.34 mm links, 0.04 mm tief
 Streuwert: 1.83, horizontal: 2.18, vertikal: 1.41

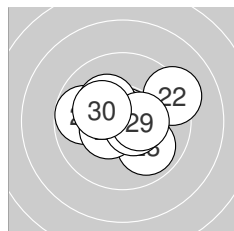

Serie 3:
 10.8 * 9.2 → 9.9 ↘ 10.8 * 9.8 ←
 10.5 * 10.6 * 10.2 * 10.4 * 10.2 *
 beste Teiler: 34.6 (21.), 45.3 (24.), 92.1 (27.)
 Trefferlage: 0.08 mm rechts, 0.23 mm hoch
 Streuwert: 1.57, horizontal: 1.94, vertikal: 1.07

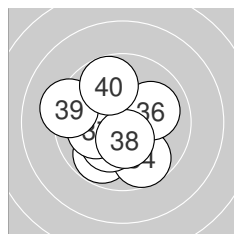

Serie 4:
 9.8 ↘ 10.4 * 10.5 * 9.7 ↘ 10.2 *
 10.0 → 10.1 ← 10.4 * 9.3 ← 9.8 ↗
 beste Teiler: 125.8 (33.), 130.2 (38.), 138.8 (32.)
 Trefferlage: 0.46 mm links, 0.60 mm tief
 Streuwert: 1.79, horizontal: 1.85, vertikal: 1.71

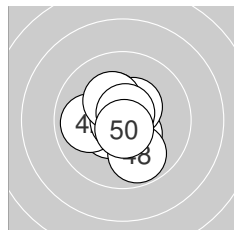

Serie 5:
 10.5 * 9.9 ← 10.4 * 10.3 * 10.9 *
 10.4 * 10.3 * 9.8 ↘ 10.7 * 10.7 *
 beste Teiler: 25.6 (45.), 57.9 (49.), 68.0 (50.)
 Trefferlage: 0.21 mm links, 0.08 mm tief
 Streuwert: 1.17, horizontal: 1.08, vertikal: 1.25

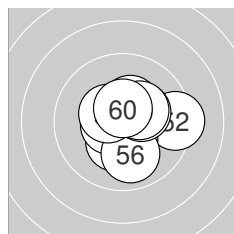

Serie 6:
 10.4 * 9.3 → 10.3 * 10.4 * 10.6 *
 10.0 ↓ 10.4 * 10.3 * 10.3 * 10.5 *
 beste Teiler: 100.6 (55.), 105.0 (60.), 129.4 (57.)
 Trefferlage: 0.57 mm rechts, 0.06 mm tief
 Streuwert: 1.39, horizontal: 1.50, vertikal: 1.27



Ergebnis: **619.5** (592)
 Serien: 99.2 102.7 104.6 103.6 104.6 104.8
 Zähler: 52 8 0 0 0 0 0 0 0
 Innenzehner: 44
 Weitest: 458 (3.), 431 (5.), 410 (4.)
 beste Teiler: 11.1 (55.), 37.1 (50.), 51.4 (1.)
 Trefferlage: 0.38 mm rechts, 0.47 mm hoch
 Streuwert: 1.24, horizontal: 1.32, vertikal: 1.16

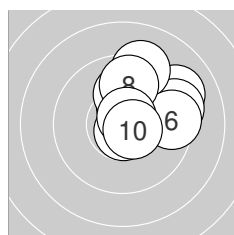
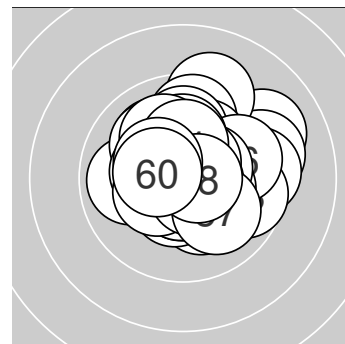

Serie 1:
 10.7 * 10.4 * 9.1 ↗ 9.3 → 9.2 ↑
 9.5 → 10.0 ↑ 9.7 ↑ 10.7 * 10.6 *
 beste Teiler: 51.4 (1.), 62.6 (9.), 85.4 (10.)
 Trefferlage: 1.49 mm rechts, 1.41 mm hoch
 Streuwert: 1.60, horizontal: 1.70, vertikal: 1.49

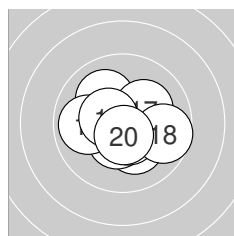

Serie 2:
 10.2 * 10.1 ↘ 10.4 * 10.5 * 9.9 ←
 10.6 * 10.2 * 9.7 → 10.5 * 10.6 *
 beste Teiler: 90.4 (20.), 95.0 (16.), 101.9 (14.)
 Trefferlage: 0.16 mm rechts, 0.22 mm tief
 Streuwert: 1.38, horizontal: 1.62, vertikal: 1.08

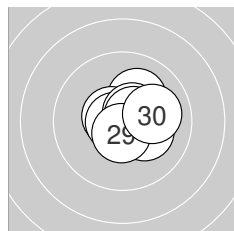

Serie 3:
 10.6 * 10.6 * 10.1 ↗ 10.6 * 10.2 *
 10.7 * 10.6 * 10.6 * 10.6 * 10.0 →
 beste Teiler: 58.3 (26.), 76.9 (22.), 90.1 (21.)
 Trefferlage: 0.59 mm rechts, 0.15 mm hoch
 Streuwert: 0.89, horizontal: 0.96, vertikal: 0.81

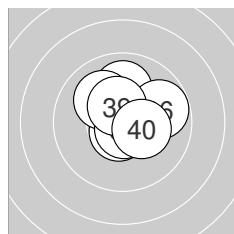

Serie 4:
 10.0 ↑ 10.6 * 10.6 * 10.5 * 10.6 *
 9.8 → 10.1 ↘ 10.7 * 10.4 * 10.3 *
 beste Teiler: 53.3 (38.), 76.6 (35.), 79.6 (32.)
 Trefferlage: 0.20 mm rechts, 0.67 mm hoch
 Streuwert: 1.10, horizontal: 1.18, vertikal: 1.02

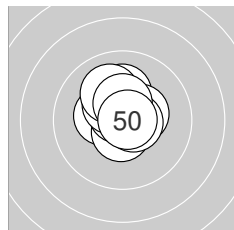

Serie 5:
 10.2 * 10.4 * 10.4 * 10.6 * 10.7 *
 10.4 * 10.1 ↘ 10.6 * 10.4 * 10.8 *
 beste Teiler: 37.1 (50.), 60.4 (45.), 83.7 (48.)
 Trefferlage: 0.12 mm links, 0.67 mm hoch
 Streuwert: 0.88, horizontal: 0.83, vertikal: 0.94

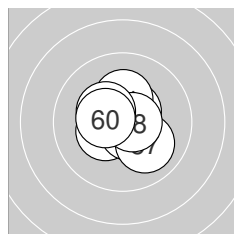

Serie 6:
 10.5 * 10.4 * 10.6 * 10.3 * 10.9 *
 10.6 * 10.0 ↘ 10.7 * 10.4 * 10.4 *
 beste Teiler: 11.1 (55.), 75.0 (58.), 83.6 (56.)
 Trefferlage: 0.02 mm links, 0.14 mm hoch
 Streuwert: 0.99, horizontal: 1.01, vertikal: 0.97



Ergebnis: **625.1** (594)
 Serien: 105.3 105.1 101.7 102.5^{OF} 105.0 105.5
 Zähler: 54 6 0 0 0 0 0 0 0
 Innenzehner: 51
 Weitester: 404 (30.), 392 (32.), 294 (27.)
 beste Teiler: 11.4 (35.), 21.9 (1.), 22.0 (57.)
 Trefferlage: 0.02 mm rechts, 0.11 mm hoch
 Streuwert: 1.13, horizontal: 1.40, vertikal: 0.76

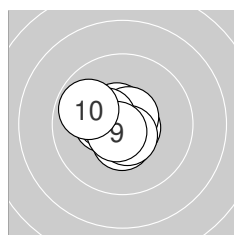
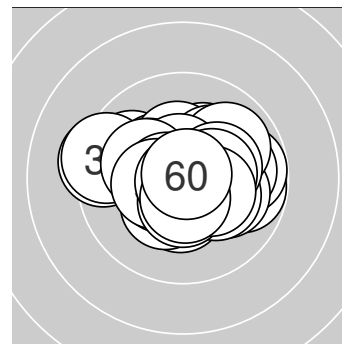

Serie 1:

10.9 *	10.6 *	10.5 *	10.7 *	10.4 *
10.7 *	10.6 *	10.4 *	10.7 *	9.8 ↖

beste Teiler: 21.9 (1.), 64.4 (4.), 70.4 (6.)
 Trefferlage: 0.48 mm links, 0.00 mm
 Streuwert: 0.87, horizontal: 0.98, vertikal: 0.75

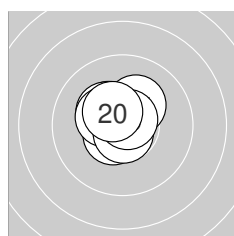

Serie 2:

10.4 *	10.8 *	10.6 *	10.3 *	10.4 *
10.5 *	10.2 *	10.7 *	10.7 *	10.5 *

beste Teiler: 41.5 (12.), 56.7 (19.), 58.2 (18.)
 Trefferlage: 0.42 mm links, 0.51 mm hoch
 Streuwert: 0.74, horizontal: 0.73, vertikal: 0.74

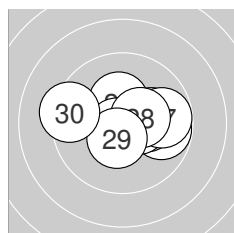

Serie 3:

9.8 →	10.3 *	10.1 →	10.5 *	10.3 *
10.7 *	9.8 →	10.4 *	10.5 *	9.3 ↖

beste Teiler: 56.7 (26.), 114.3 (24.), 119.6 (29.)
 Trefferlage: 0.70 mm rechts, 0.16 mm hoch
 Streuwert: 1.56, horizontal: 2.07, vertikal: 0.74

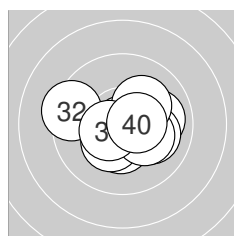

Serie 4:

10.4 *	9.4 ↖	10.3 *	10.0 →	10.9 *
10.1 ↘	10.2 *	10.2 *	10.5 *	10.5 *

beste Teiler: 11.4 (35.), 106.4 (40.), 110.9 (39.)
 Trefferlage: 0.28 mm rechts, 0.20 mm tief
 Streuwert: 1.48, horizontal: 1.87, vertikal: 0.94

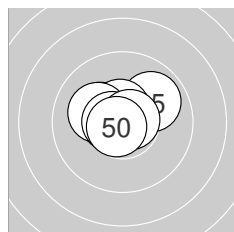

Serie 5:

10.2 *	10.6 *	10.7 *	10.8 *	9.9 ↗
10.6 *	10.2 *	10.6 *	10.7 *	10.7 *

beste Teiler: 42.1 (44.), 55.9 (49.), 56.4 (50.)
 Trefferlage: 0.37 mm links, 0.48 mm hoch
 Streuwert: 0.88, horizontal: 1.13, vertikal: 0.53

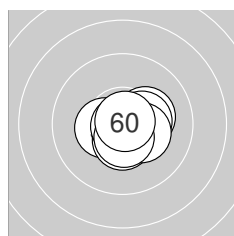

Serie 6:

10.2 *	10.6 *	10.4 *	10.4 *	10.8 *
10.5 *	10.9 *	10.3 *	10.6 *	10.8 *

beste Teiler: 22.0 (57.), 26.9 (60.), 43.9 (55.)
 Trefferlage: 0.42 mm rechts, 0.29 mm tief
 Streuwert: 0.75, horizontal: 0.92, vertikal: 0.54



ISSF AR Women – Wertung – Frauen

StandNr: 118

Brabcova, Karolina #70507115

StartNr: 16

4. November 2022 10:07

CZE

QF

– Schütze hat sich fürs Finale qualifiziert



Ergebnis: **623.8** (595)
 Serien: 102.9 102.7 105.1 104.8^{OF} 103.4 104.9
 0.0
 Zähler: 55 5 0 0 0 0 0 0 0
 Innenzehner: 49
 Weitestе: 425 (11.), 347 (48.), 324 (5.)
 beste Teiler: 23.0 (55.), 24.3 (54.), 28.2 (32.)
 Trefferlage: 0.05 mm rechts, 0.20 mm hoch
 Streuwert: 1.15, horizontal: 1.24, vertikal: 1.06

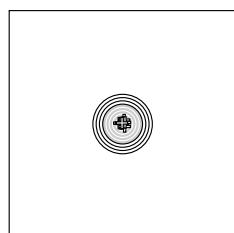
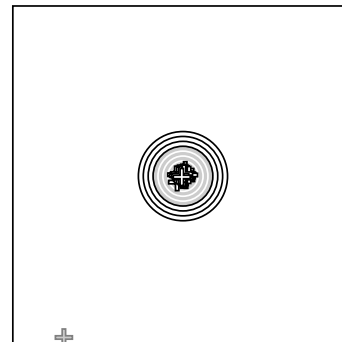

Serie 1:
 10.6 * 9.9 ← 10.6 * 10.6 * 9.7 ↑
 10.4 * 10.0 ↘ 10.4 * 10.1 ↗ 10.6 *
 beste Teiler: 76.0 (1.), 83.5 (3.), 94.3 (10.)
 Trefferlage: 0.07 mm rechts, 0.79 mm hoch
 Streuwert: 1.28, horizontal: 1.37, vertikal: 1.18

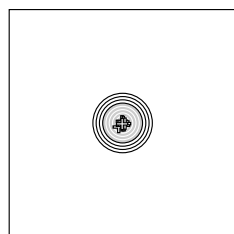

Serie 2:
 9.3 ↗ 10.3 * 10.2 * 10.6 * 10.4 *
 10.4 * 10.5 * 10.1 ↘ 10.2 * 10.7 *
 beste Teiler: 75.5 (20.), 89.6 (14.), 101.8 (17.)
 Trefferlage: 0.05 mm rechts, 0.64 mm tief
 Streuwert: 1.37, horizontal: 1.33, vertikal: 1.41

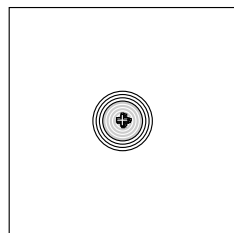

Serie 3:
 10.0 → 10.3 * 10.6 * 10.8 * 10.8 *
 10.3 * 10.5 * 10.8 * 10.3 * 10.7 *
 beste Teiler: 42.4 (24.), 42.4 (28.), 48.3 (25.)
 Trefferlage: 0.44 mm rechts, 0.44 mm hoch
 Streuwert: 0.88, horizontal: 0.89, vertikal: 0.87

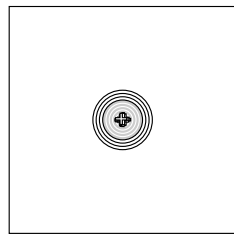

Serie 4:
 10.4 * 10.8 * 10.5 * 10.4 * 10.2 *
 10.6 * 10.3 * 10.6 * 10.6 * 10.4 *
 beste Teiler: 28.2 (32.), 82.8 (36.), 88.6 (38.)
 Trefferlage: 0.05 mm rechts, 0.28 mm hoch
 Streuwert: 0.89, horizontal: 1.08, vertikal: 0.65

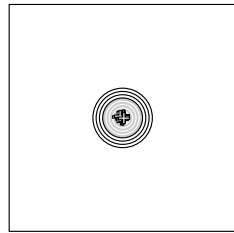

Serie 5:
 10.4 * 10.5 * 10.5 * 10.6 * 10.5 *
 10.2 * 10.5 * 9.6 ← 10.0 ↖ 10.6 *
 beste Teiler: 97.2 (50.), 100.4 (44.), 106.0 (45.)
 Trefferlage: 0.23 mm links, 0.30 mm hoch
 Streuwert: 1.25, horizontal: 1.47, vertikal: 1.00

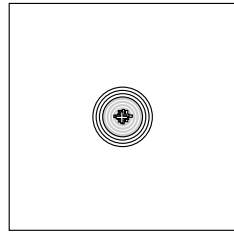

Serie 6:
 9.7 → 10.0 ← 10.7 * 10.9 * 10.9 *
 10.7 * 10.5 * 10.4 * 10.4 * 10.7 *
 beste Teiler: 23.0 (55.), 24.3 (54.), 52.1 (53.)
 Trefferlage: 0.05 mm links, 0.06 mm hoch
 Streuwert: 1.12, horizontal: 1.42, vertikal: 0.68



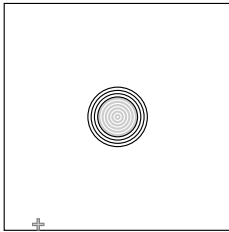

Serie 7:

0.0+ ↙

^{AST,NSC}

beste Teiler:

Trefferlage: 0.00 mm , 0.00 mm

Streuwert: 0.00, horizontal: 0.00, vertikal: 0.00

AST
NSC
QF

- Treffer wurde nach Ende der Schießzeit abgegeben
- Treffer wurde vermessen, geht aber nicht in die Wertung ein
- Schütze hat sich fürs Finale qualifiziert



Ergebnis: **627.8** (598)
 Serien: 103.4 104.4 104.5 105.1^{OF} 106.0 104.4
 Zähler: 58 2 0 0 0 0 0 0 0
 Innenzehner: 53
 Weitestе: 313 (10.), 312 (29.), 248 (4.)
 beste Teiler: 7.0 (40.), 34.7 (5.), 39.8 (23.)
 Trefferlage: 0.02 mm rechts, 0.32 mm hoch
 Streuwert: 0.97, horizontal: 1.12, vertikal: 0.79

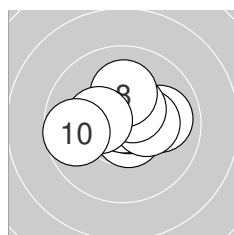
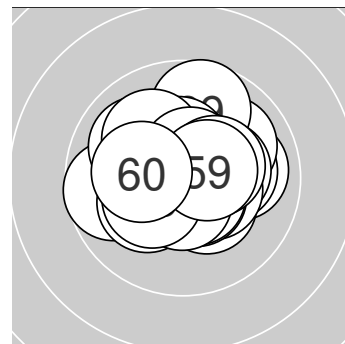

Serie 1:

10.6 *	10.7 *	10.4 *	10.0 →	10.8 *
10.3 *	10.5 *	10.1 ↑	10.3 *	9.7 ←

beste Teiler: 34.7 (5.), 52.1 (2.), 76.3 (1.)
 Trefferlage: 0.23 mm rechts, 0.36 mm hoch
 Streuwert: 1.24, horizontal: 1.59, vertikal: 0.76

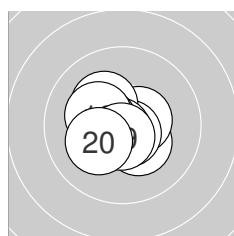

Serie 2:

10.3 *	10.5 *	10.7 *	10.4 *	10.2 *
10.8 *	10.4 *	10.3 *	10.6 *	10.2 *

beste Teiler: 50.9 (16.), 63.8 (13.), 76.5 (19.)
 Trefferlage: 0.49 mm links, 0.05 mm tief
 Streuwert: 0.95, horizontal: 1.06, vertikal: 0.84

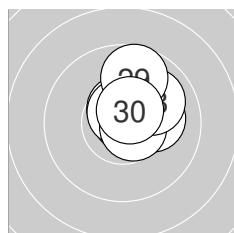

Serie 3:

10.6 *	10.6 *	10.8 *	10.7 *	10.2 *
10.7 *	10.6 *	10.0 ↗	9.7 ↑	10.6 *

beste Teiler: 39.8 (23.), 64.1 (24.), 74.1 (26.)
 Trefferlage: 0.63 mm rechts, 0.87 mm hoch
 Streuwert: 0.83, horizontal: 0.77, vertikal: 0.88

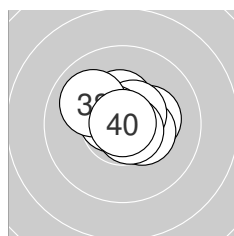

Serie 4:

10.6 *	10.6 *	10.3 *	10.4 *	10.4 *
10.6 *	10.6 *	10.0 ↘	10.7 *	10.9 *

beste Teiler: 7.0 (40.), 65.9 (39.), 76.5 (31.)
 Trefferlage: 0.22 mm rechts, 0.46 mm hoch
 Streuwert: 0.86, horizontal: 1.04, vertikal: 0.65

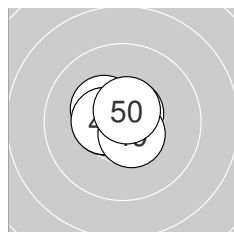

Serie 5:

10.8 *	10.7 *	10.3 *	10.8 *	10.7 *
10.5 *	10.5 *	10.5 *	10.6 *	10.6 *

beste Teiler: 44.5 (41.), 44.7 (44.), 55.2 (42.)
 Trefferlage: 0.31 mm links, 0.22 mm hoch
 Streuwert: 0.66, horizontal: 0.76, vertikal: 0.53

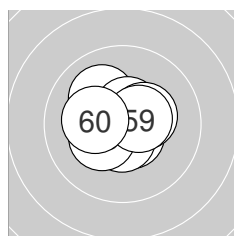

Serie 6:

10.1 ↖	10.5 *	10.6 *	10.7 *	10.6 *
10.3 *	10.6 *	10.3 *	10.5 *	10.2 *

beste Teiler: 72.4 (54.), 92.8 (53.), 97.0 (57.)
 Trefferlage: 0.14 mm links, 0.08 mm hoch
 Streuwert: 1.02, horizontal: 1.14, vertikal: 0.87



ISSF AR Women – Wertung – Frauen

StandNr: 120

Thurnwaldova, Sabina #70507097

StartNr: 18

4. November 2022 9:54

CZE

QF

– Schütze hat sich fürs Finale qualifiziert



Ergebnis: **629.7** (599)
 Serien: 106.9 103.7 105.6 104.4^{OF} 105.0 104.1
 Zähler: 59 1 0 0 0 0 0 0 0
 Innenzehner: 55
 Weitester: 356 (34.), 248 (18.), 219 (19.)
 beste Teiler: 9.8 (25.), 12.2 (1.), 20.1 (10.)
 Trefferlage: 0.25 mm links, 0.03 mm tief
 Streuwert: 0.91, horizontal: 0.99, vertikal: 0.82

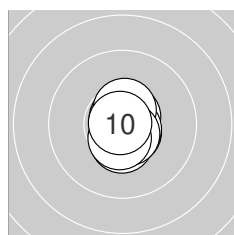
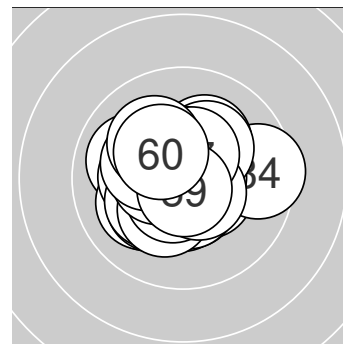

Serie 1:

10.9 *	10.7 *	10.8 *	10.7 *	10.5 *
10.7 *	10.5 *	10.6 *	10.6 *	10.9 *

beste Teiler: 12.2 (1.), 20.1 (10.), 43.0 (3.)
 Trefferlage: 0.15 mm rechts, 0.18 mm tief
 Streuwert: 0.54, horizontal: 0.29, vertikal: 0.71

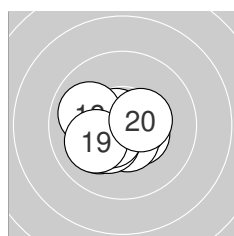

Serie 2:

10.1 ↙	10.5 *	10.6 *	10.5 *	10.3 *
10.7 *	10.5 *	10.0 ↖	10.1 ↙	10.4 *

beste Teiler: 58.4 (16.), 87.2 (13.), 111.3 (14.)
 Trefferlage: 0.45 mm links, 0.44 mm tief
 Streuwert: 1.06, horizontal: 1.30, vertikal: 0.76

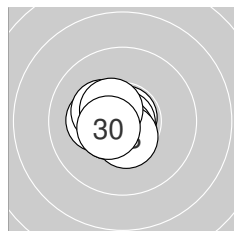

Serie 3:

10.2 *	10.8 *	10.5 *	10.3 *	10.9 *
10.7 *	10.7 *	10.5 *	10.5 *	10.5 *

beste Teiler: 9.8 (25.), 32.8 (22.), 55.4 (26.)
 Trefferlage: 0.60 mm links, 0.09 mm tief
 Streuwert: 0.65, horizontal: 0.71, vertikal: 0.59

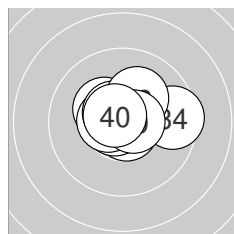

Serie 4:

10.7 *	10.7 *	10.3 *	9.5 →	10.5 *
10.6 *	10.6 *	10.2 *	10.6 *	10.7 *

beste Teiler: 57.0 (32.), 58.1 (31.), 72.3 (40.)
 Trefferlage: 0.22 mm rechts, 0.41 mm hoch
 Streuwert: 1.09, horizontal: 1.41, vertikal: 0.62

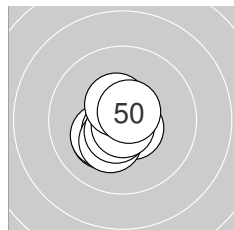

Serie 5:

10.5 *	10.2 *	10.2 *	10.6 *	10.6 *
10.3 *	10.6 *	10.8 *	10.5 *	10.7 *

beste Teiler: 42.0 (48.), 75.0 (50.), 87.3 (44.)
 Trefferlage: 0.49 mm links, 0.53 mm tief
 Streuwert: 0.75, horizontal: 0.71, vertikal: 0.80

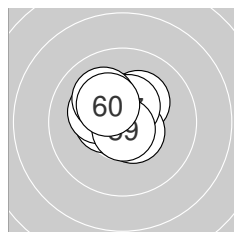

Serie 6:

10.2 *	10.5 *	10.5 *	10.6 *	10.2 *
10.5 *	10.5 *	10.1 ↘	10.7 *	10.3 *

beste Teiler: 52.4 (59.), 90.4 (54.), 101.2 (56.)
 Trefferlage: 0.37 mm links, 0.66 mm hoch
 Streuwert: 0.89, horizontal: 0.95, vertikal: 0.81



ISSF AR Women – Wertung – Frauen

StandNr: 121

Pribitzer, Marlene #164

StartNr: 19

4. November 2022 10:11

AUT

QF

– Schütze hat sich fürs Finale qualifiziert



Ergebnis: **625.6** (595)
 Serien: 101.3 105.3 105.3 104.5^{OF} 104.4 104.8
 Zähler: 55 5 0 0 0 0 0 0 0
 Innenzehner: 50
 Weitest: 453 (4.), 369 (5.), 292 (3.)
 beste Teiler: 16.0 (33.), 18.4 (41.), 23.7 (48.)
 Trefferlage: 0.08 mm links, 0.25 mm hoch
 Streuwert: 1.09, horizontal: 1.24, vertikal: 0.91

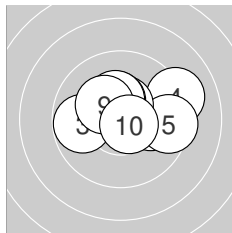
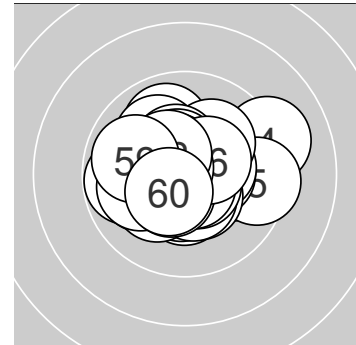

Serie 1:
 10.7 * 10.0 → 9.8 ← 9.1 ↗ 9.5 →
 10.5 * 10.4 * 10.3 * 10.3 * 10.7 *
 beste Teiler: 68.3 (1.), 74.9 (10.), 111.0 (6.)
 Trefferlage: 0.59 mm rechts, 0.62 mm hoch
 Streuwert: 1.67, horizontal: 2.20, vertikal: 0.86

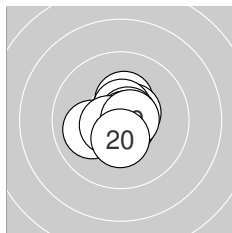

Serie 2:
 10.3 * 10.5 * 10.6 * 10.7 * 10.0 ←
 10.7 * 10.8 * 10.6 * 10.7 * 10.4 *
 beste Teiler: 38.0 (17.), 57.3 (14.), 62.6 (16.)
 Trefferlage: 0.01 mm rechts, 0.04 mm hoch
 Streuwert: 0.87, horizontal: 0.92, vertikal: 0.83

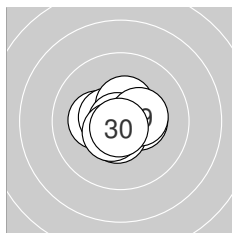

Serie 3:
 10.2 * 10.5 * 10.7 * 10.5 * 10.8 *
 10.4 * 10.5 * 10.5 * 10.4 * 10.8 *
 beste Teiler: 26.6 (25.), 50.6 (30.), 52.4 (23.)
 Trefferlage: 0.13 mm links, 0.08 mm tief
 Streuwert: 0.83, horizontal: 0.98, vertikal: 0.64

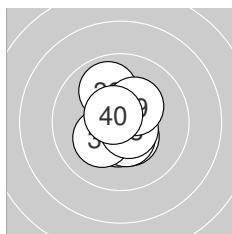

Serie 4:
 10.6 * 9.9 ↘ 10.9 * 10.4 * 10.5 *
 10.5 * 10.2 * 10.6 * 10.3 * 10.6 *
 beste Teiler: 16.0 (33.), 78.4 (40.), 83.7 (38.)
 Trefferlage: 0.09 mm links, 0.02 mm tief
 Streuwert: 1.05, horizontal: 0.79, vertikal: 1.25

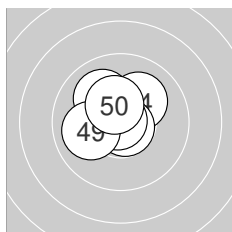

Serie 5:
 10.9 * 10.5 * 10.5 * 10.1 ↗ 10.7 *
 10.4 * 10.0 ↘ 10.9 * 10.0 ← 10.4 *
 beste Teiler: 18.4 (41.), 23.7 (48.), 51.6 (45.)
 Trefferlage: 0.33 mm links, 0.71 mm hoch
 Streuwert: 0.95, horizontal: 1.04, vertikal: 0.85

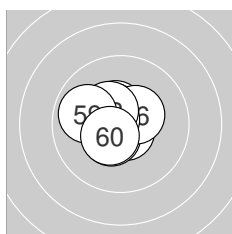

Serie 6:
 10.5 * 10.7 * 10.8 * 10.5 * 10.5 *
 10.4 * 10.6 * 10.4 * 9.9 ← 10.5 *
 beste Teiler: 47.3 (53.), 65.7 (52.), 85.6 (57.)
 Trefferlage: 0.55 mm links, 0.27 mm hoch
 Streuwert: 0.87, horizontal: 0.94, vertikal: 0.79



ISSF AR Women – Wertung – Frauen

StandNr: 122

Foistova, Nikola #70507112

StartNr: 20

4. November 2022 9:52

CZE

QF

– Schütze hat sich fürs Finale qualifiziert

