

Ergebnis: 307.8 (293)
Serien: 104.1 100.9 102.8
Zähler: 23 7 0 0 0 0 0 0 0 0
Innenzehner: 20
Weiteste: 358 (8.), 297 (11.), 289 (14.)
beste Teiler: 10.0 (6.), 44.0 (7.), 58.0 (1.)
Trefferlage: 0.17 mm links, 0.05 mm tief
Streuwert: 1.37, horizontal: 1.50, vertikal: 1.22

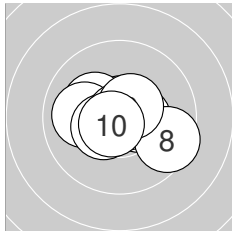
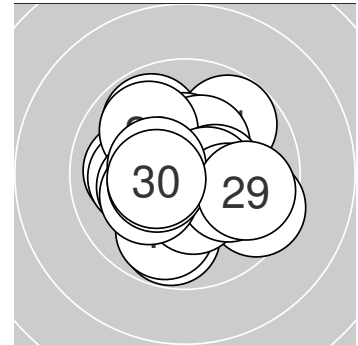

Serie 1: 104.1 (99)

10.7* ↑	10.2* ↖	10.4* →	10.0 ←	10.4* ↙
10.9* ↑	10.8* →	9.5 ↘	10.5* ↗	10.7* ↘

beste Teiler: 10.0 (6.), 44.0 (7.), 58.0 (1.)
Trefferlage: 0.00 mm , 0.03 mm tief
Streuwert: 1.24, horizontal: 1.60, vertikal: 0.71

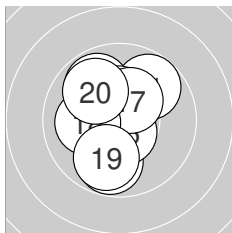

Serie 2: 100.9 (95)

9.8 ↗	9.8 ↘	10.3* ↖	9.8 ↓	10.6* ↓
10.4* ↑	10.3* ↗	10.1 ←	9.9 ↓	9.9 ↘

beste Teiler: 86.3 (15.), 146.2 (16.), 153.0 (17.)
Trefferlage: 0.55 mm links, 0.35 mm hoch
Streuwert: 1.62, horizontal: 1.28, vertikal: 1.90

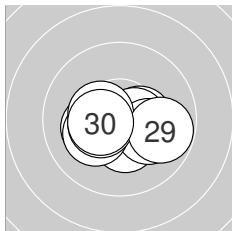

Serie 3: 102.8 (99)

10.4* →	10.4* ↓	10.5* →	10.2* ←	10.1 ↘
10.2* ↙	10.4* ↙	10.4* ↖	9.8 →	10.4* ←

beste Teiler: 101.4 (23.), 131.8 (30.), 133.6 (28.)
Trefferlage: 0.02 mm rechts, 0.48 mm tief
Streuwert: 1.25, horizontal: 1.68, vertikal: 0.52



Ergebnis: 311.5 (300)
Serien: 102.4 104.0 105.1
Zähler: 30 0 0 0 0 0 0 0 0 0 0
Innenzehner: 22
Weiteste: 248 (14.), 242 (1.), 225 (13.)
beste Teiler: 28.0 (16.), 42.8 (22.), 46.6 (20.)
Trefferlage: 0.33 mm rechts, 0.51 mm hoch
Streuwert: 1.03, horizontal: 1.17, vertikal: 0.88

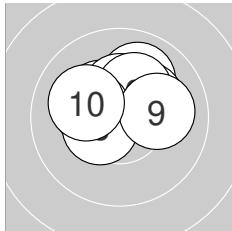
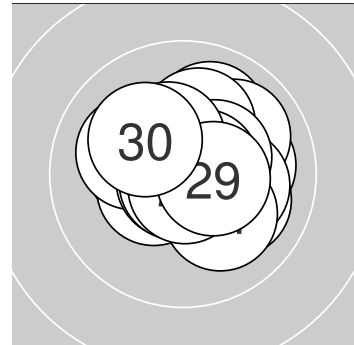

Serie 1: 102.4 (100)

10.0 ↗	10.2* ↘	10.3* ↘	10.3* ↑	10.5* ↗
10.2* ↗	10.3* ↖	10.4* ↖	10.1 →	10.1 ↖

beste Teiler: 111.1 (5.), 127.9 (8.), 151.0 (4.)
Trefferlage: 0.05 mm rechts, 0.92 mm hoch
Streuwert: 1.15, horizontal: 1.44, vertikal: 0.76

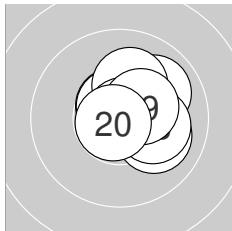

Serie 2: 104.0 (100)

10.6* ↘	10.6* ↘	10.1 ↘	10.0 ↗	10.1 ↑
10.8* ↗	10.4* →	10.2* →	10.4* ↗	10.8* ↗

beste Teiler: 28.0 (16.), 46.6 (20.), 76.5 (12.)
Trefferlage: 0.84 mm rechts, 0.42 mm hoch
Streuwert: 0.95, horizontal: 1.01, vertikal: 0.88

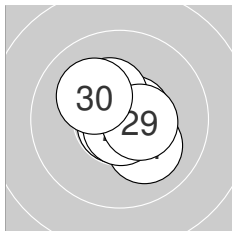

Serie 3: 105.1 (100)

10.7* ↘	10.8* ↗	10.6* →	10.1 ↘	10.6* →
10.5* ↘	10.8* ↓	10.4* ↘	10.5* →	10.1 ↖

beste Teiler: 42.8 (22.), 49.6 (27.), 64.1 (21.)
Trefferlage: 0.11 mm rechts, 0.19 mm hoch
Streuwert: 0.93, horizontal: 0.93, vertikal: 0.92



Ergebnis: **315.6** (299)
 Serien: 105.1 105.4 105.1
 Zähler: 29 1 0 0 0 0 0 0 0 0 0
 Innenzehner: 29
 Weitesten: 277 (11.), 199 (27.), 189 (3.)
 beste Teiler: 21.2 (19.), 22.0 (16.), 22.0 (23.)
 Trefferlage: 0.14 mm links, 0.02 mm hoch
 Streuwert: 0.89, horizontal: 1.03, vertikal: 0.73

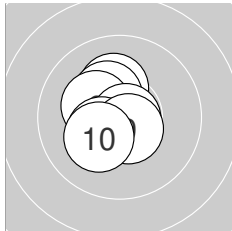
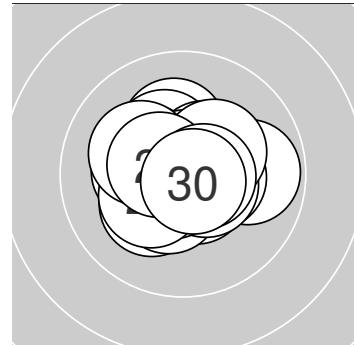

Serie 1: 105.1 (100)

10.7* ←	10.8* ↓	10.2* ↑	10.8* ↘	10.3* ↖
10.3* ↖	10.8* →	10.4* ↗	10.6* ↘	10.2* ↗

beste Teiler: 37.5 (2.), 41.0 (7.), 45.4 (4.)
 Trefferlage: 0.46 mm links, 0.00 mm
 Streuwert: 0.88, horizontal: 0.74, vertikal: 1.01

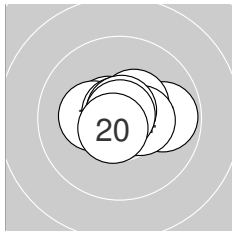

Serie 2: 105.4 (99)

9.8 →	10.4* ↗	10.6* ↖	10.4* →	10.3* ←
10.9* ←	10.8* ↖	10.7* ↑	10.9* ↑	10.6* ↗

beste Teiler: 21.2 (19.), 22.0 (16.), 42.5 (17.)
 Trefferlage: 0.19 mm rechts, 0.18 mm hoch
 Streuwert: 0.91, horizontal: 1.22, vertikal: 0.41

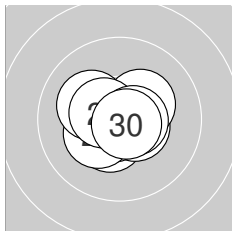

Serie 3: 105.1 (100)

10.4* ↓	10.5* ↘	10.9* ←	10.7* ↗	10.3* ↗
10.3* ↗	10.2* ↖	10.5* ↖	10.6* →	10.7* ↘

beste Teiler: 22.0 (23.), 53.8 (30.), 70.7 (24.)
 Trefferlage: 0.18 mm links, 0.11 mm tief
 Streuwert: 0.90, horizontal: 1.06, vertikal: 0.70



Ergebnis: 304.9 (290)
Serien: 101.9 101.5 101.5
Zähler: 20 10 0 0 0 0 0 0 0 0
Innenzehner: 16
Weiteste: 356 (28.), 344 (17.), 337 (16.)
beste Teiler: 29.7 (27.), 30.3 (13.), 45.6 (12.)
Trefferlage: 0.17 mm rechts, 0.37 mm hoch
Streuwert: 1.55, horizontal: 1.52, vertikal: 1.57

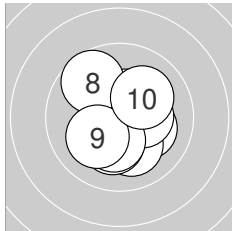
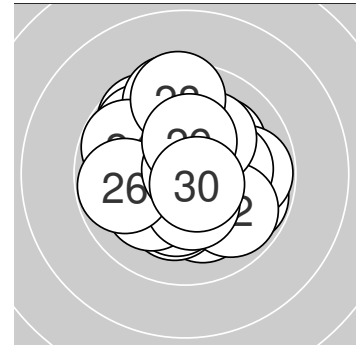

Serie 1: 101.9 (99)

10.4* →	10.2* ↘	10.1 ↓	10.3* →	10.5* ↑
10.2* ↓	10.3* ↓	9.7 ↙	10.1 ↖	10.1 ↗

beste Teiler: 123.3 (5.), 139.2 (1.), 159.1 (4.)
Trefferlage: 0.31 mm rechts, 0.19 mm tief
Streuwert: 1.46, horizontal: 1.36, vertikal: 1.56

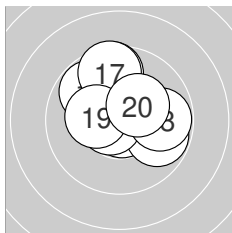

Serie 2: 101.5 (95)

9.8 ↘	10.8* ↓	10.8* ↑	9.8 →	10.7* ←
9.6 ↑	9.6 ↑	9.8 →	10.3* ←	10.3* ↗

beste Teiler: 30.3 (13.), 45.6 (12.), 68.6 (15.)
Trefferlage: 0.12 mm rechts, 0.87 mm hoch
Streuwert: 1.61, horizontal: 1.66, vertikal: 1.55

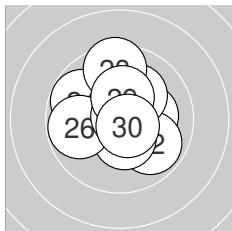

Serie 3: 101.5 (96)

10.2* →	9.9 ↘	10.4* ↓	9.8 ↘	10.1 ↗
9.8 ←	10.8* ↗	9.5 ↑	10.3* ↑	10.7* ↘

beste Teiler: 29.7 (27.), 74.5 (30.), 138.4 (23.)
Trefferlage: 0.07 mm rechts, 0.44 mm hoch
Streuwert: 1.64, horizontal: 1.68, vertikal: 1.59



Ergebnis: **316.1** (298)
 Serien: 103.1 106.1 106.9
 Zähler: 28 2 0 0 0 0 0 0 0 0 0
 Innenzehner: 27
 Weitesten: 385 (1.), 256 (3.), 239 (6.)
 beste Teiler: 4.0 (28.), 16.1 (7.), 34.4 (18.)
 Trefferlage: 0.20 mm rechts, 0.38 mm tief
 Streuwert: 0.90, horizontal: 1.05, vertikal: 0.74

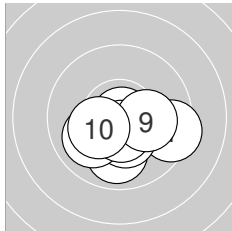
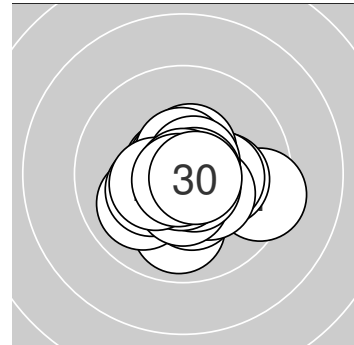

Serie 1: 103.1 (98)

9.4 →	10.8* ↘	9.9 ↓	10.4* ↓	10.7* ↓
10.0 ↙	10.9* →	10.5* ↓	10.2* →	10.3* ↙

beste Teiler: 16.1 (7.), 46.0 (2.), 64.4 (5.)
 Trefferlage: 0.28 mm rechts, 0.93 mm tief
 Streuwert: 1.25, horizontal: 1.61, vertikal: 0.74

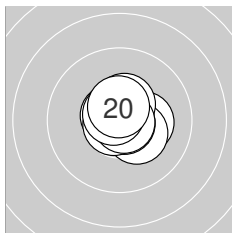

Serie 2: 106.1 (100)

10.7* ↖	10.3* →	10.7* ↘	10.3* ↘	10.8* ↘
10.7* ↙	10.5* ↑	10.8* ↘	10.7* ↖	10.6* ↑

beste Teiler: 34.4 (18.), 40.2 (15.), 52.2 (16.)
 Trefferlage: 0.28 mm rechts, 0.07 mm hoch
 Streuwert: 0.69, horizontal: 0.74, vertikal: 0.64

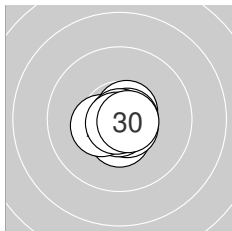

Serie 3: 106.9 (100)

10.5* ↓	10.6* ↘	10.8* ↓	10.7* ↗	10.8* ↓
10.4* ↙	10.7* →	10.9* ↓	10.8* ↙	10.7* →

beste Teiler: 4.0 (28.), 37.0 (29.), 42.5 (23.)
 Trefferlage: 0.04 mm rechts, 0.30 mm tief
 Streuwert: 0.52, horizontal: 0.58, vertikal: 0.46



Ergebnis: **312.9** (296)
 Serien: 103.6 103.5 105.8
 Zähler: 26 4 0 0 0 0 0 0 0 0
 Innenzehner: 23
 Weitesten: 298 (10.), 284 (7.), 261 (2.)
 beste Teiler: 21.0 (17.), 21.5 (12.), 29.2 (3.)
 Trefferlage: 0.19 mm rechts, 0.41 mm hoch
 Streuwert: 1.07, horizontal: 1.01, vertikal: 1.12

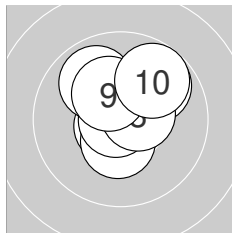
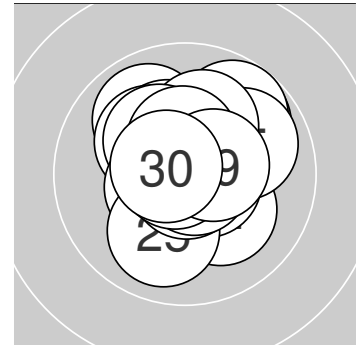

Serie 1: 103.6 (97)

10.7* ↙	9.9 ↘	10.8* ↙	10.4* ↓	10.6* ↗
10.8* ←	9.8 ↗	10.5* →	10.3* ↘	9.8 ↗

beste Teiler: 29.2 (3.), 29.2 (6.), 69.4 (1.)
 Trefferlage: 0.20 mm rechts, 0.71 mm hoch
 Streuwert: 1.19, horizontal: 1.14, vertikal: 1.24

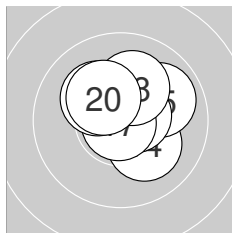

Serie 2: 103.5 (99)

10.1 ↗	10.9* →	10.3* ↑	10.2* ↘	9.9 ↗
10.6* →	10.9* ↙	10.1 ↑	10.2* ↘	10.3* ↘

beste Teiler: 21.0 (17.), 21.5 (12.), 86.0 (16.)
 Trefferlage: 0.49 mm rechts, 0.73 mm hoch
 Streuwert: 1.09, horizontal: 1.15, vertikal: 1.04

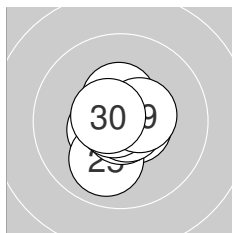

Serie 3: 105.8 (100)

10.6* →	10.4* ↑	10.8* ↙	10.5* ↙	10.0 ↓
10.8* ↓	10.8* ↘	10.8* ←	10.5* →	10.6* ↙

beste Teiler: 35.5 (26.), 40.3 (28.), 42.9 (27.)
 Trefferlage: 0.11 mm links, 0.19 mm tief
 Streuwert: 0.81, horizontal: 0.71, vertikal: 0.90



Ergebnis: 313.1 (300)
Serien: 104.5 104.3 104.3
Zähler: 30 0 0 0 0 0 0 0 0 0
Innenzehner: 24
Weiteste: 239 (27.), 222 (25.), 209 (6.)
beste Teiler: 17.0 (21.), 39.3 (1.), 40.4 (8.)
Trefferlage: 0.26 mm rechts, 0.13 mm hoch
Streuwert: 1.03, horizontal: 1.14, vertikal: 0.89

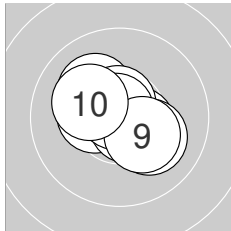
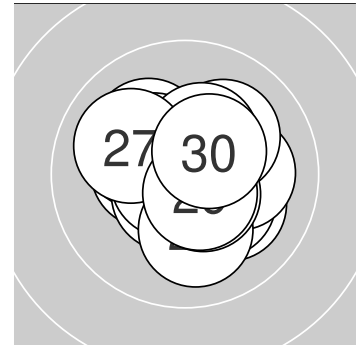

Serie 1: 104.5 (100)

10.8* ↖	10.4* ←	10.7* ↘	10.1 ↖	10.5* ↘
10.1 ↘	10.6* ↑	10.8* ↖	10.3* ↘	10.2* ↖

beste Teiler: 39.3 (1.), 40.4 (8.), 65.0 (3.)
Trefferlage: 0.05 mm links, 0.09 mm hoch
Streuwert: 1.05, horizontal: 1.22, vertikal: 0.86

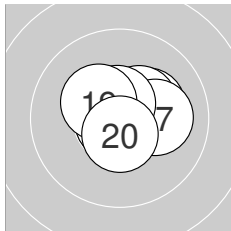

Serie 2: 104.3 (100)

10.2* →	10.8* ↗	10.3* →	10.2* ↗	10.4* ↗
10.8* ↖	10.1 →	10.6* ↑	10.3* ↖	10.6* ↓

beste Teiler: 44.4 (16.), 49.4 (12.), 86.9 (18.)
Trefferlage: 0.71 mm rechts, 0.31 mm hoch
Streuwert: 0.91, horizontal: 1.14, vertikal: 0.59

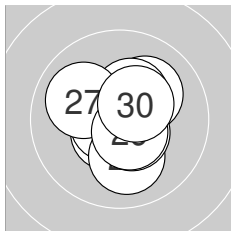

Serie 3: 104.3 (100)

10.9* ↓	10.1 ↗	10.6* ↗	10.7* ←	10.1 ↓
10.4* ↗	10.0 ↖	10.5* ↘	10.6* ↘	10.4* ↗

beste Teiler: 17.0 (21.), 71.1 (24.), 94.6 (29.)
Trefferlage: 0.13 mm rechts, 0.00 mm
Streuwert: 1.11, horizontal: 1.04, vertikal: 1.18



Ergebnis: 311.7 (296)
Serien: 105.6 102.5 103.6
Zähler: 26 4 0 0 0 0 0 0 0 0
Innenzehner: 23
Weiteste: 407 (15.), 293 (17.), 280 (22.)
beste Teiler: 17.8 (3.), 24.3 (27.), 28.1 (6.)
Trefferlage: 0.38 mm links, 0.06 mm tief
Streuwert: 1.17, horizontal: 1.33, vertikal: 0.98

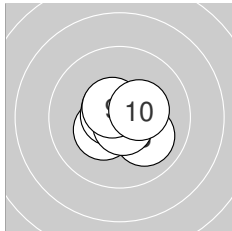
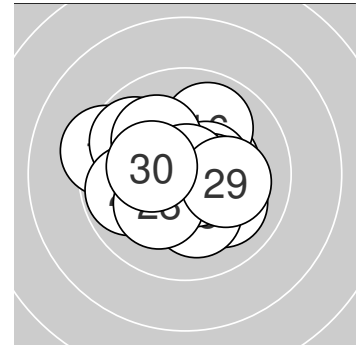

Serie 1: 105.6 (100)

10.4* ↙	10.6* ↘	10.9* ↗	10.6* ↖	10.0 ↘
10.8* ←	10.7* ←	10.7* ↓	10.6* ↖	10.3* →

beste Teiler: 17.8 (3.), 28.1 (6.), 63.5 (8.)
Trefferlage: 0.00 mm , 0.02 mm tief
Streuwert: 0.85, horizontal: 0.96, vertikal: 0.71

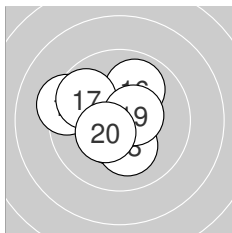

Serie 2: 102.5 (97)

10.5* ↙	10.6* ↙	10.8* ↑	10.5* ↙	9.3 ↖
9.9 ↗	9.8 ↘	10.2* ↓	10.5* →	10.4* ↙

beste Teiler: 47.6 (13.), 86.2 (12.), 109.1 (19.)
Trefferlage: 0.67 mm links, 0.05 mm hoch
Streuwert: 1.45, horizontal: 1.57, vertikal: 1.33

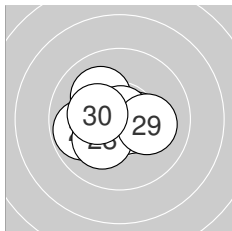

Serie 3: 103.6 (99)

10.7* ↙	9.8 ↖	10.1 ↘	10.5* →	10.3* ↙
10.7* ↘	10.9* ↗	10.2* ↙	10.1 →	10.3* ↖

beste Teiler: 24.3 (27.), 59.4 (26.), 59.9 (21.)
Trefferlage: 0.48 mm links, 0.23 mm tief
Streuwert: 1.19, horizontal: 1.43, vertikal: 0.87



Ergebnis: 311.1 (299)
Serien: 102.8 105.5 102.8
Zähler: 29 1 0 0 0 0 0 0 0 0
Innenzehner: 25
Weiteste: 457 (29.), 248 (23.), 229 (10.)
beste Teiler: 14.7 (18.), 25.0 (11.), 47.8 (13.)
Trefferlage: 0.52 mm links, 0.17 mm tief
Streuwert: 1.15, horizontal: 1.42, vertikal: 0.80

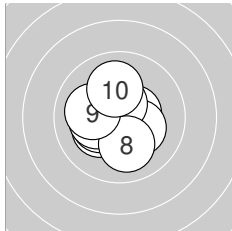
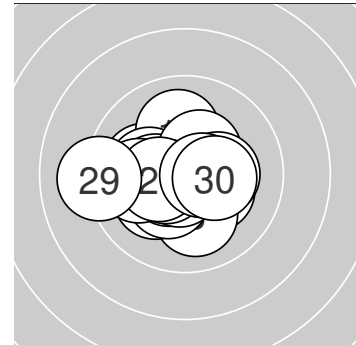

Serie 1: 102.8 (100)

10.6* ↘	10.2* ↙	10.3* ←	10.5* →	10.3* ↘
10.5* ↑	10.2* ←	10.1 ↓	10.1 ←	10.0 ↑

beste Teiler: 100.1 (1.), 107.0 (6.), 115.2 (4.)
Trefferlage: 0.34 mm links, 0.11 mm tief
Streuwert: 1.28, horizontal: 1.35, vertikal: 1.21

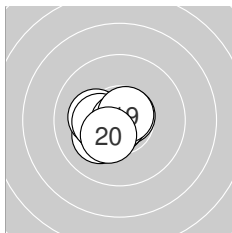

Serie 2: 105.5 (100)

10.9* ↙	10.2* ↙	10.8* ↙	10.4* ↙	10.7* ↗
10.2* ←	10.3* ←	10.9* ↙	10.7* ↗	10.4* ↙

beste Teiler: 14.7 (18.), 25.0 (11.), 47.8 (13.)
Trefferlage: 0.66 mm links, 0.26 mm tief
Streuwert: 0.75, horizontal: 0.88, vertikal: 0.59

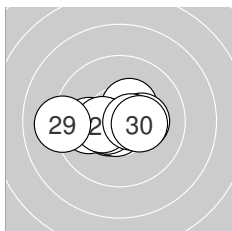

Serie 3: 102.8 (99)

10.5* ↙	10.4* ↗	10.0 ←	10.7* ↙	10.5* ↙
10.3* →	10.4* ←	10.6* →	9.1 ←	10.3* →

beste Teiler: 63.9 (24.), 90.1 (28.), 101.0 (21.)
Trefferlage: 0.55 mm links, 0.14 mm tief
Streuwert: 1.43, horizontal: 1.96, vertikal: 0.50



Ergebnis: **308.0** (292)
 Serien: 104.2 104.4 99.4
 Zähler: 23 6 1 0 0 0 0 0 0 0
 Innenzehner: 21
 Weitesten: 608 (26.), 402 (27.), 355 (23.)
 beste Teiler: 18.9 (4.), 24.5 (28.), 28.0 (8.)
 Trefferlage: 0.39 mm rechts, 0.38 mm hoch
 Streuwert: 1.49, horizontal: 1.63, vertikal: 1.32

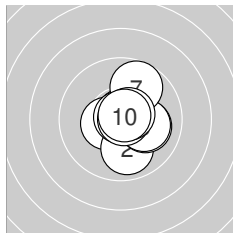
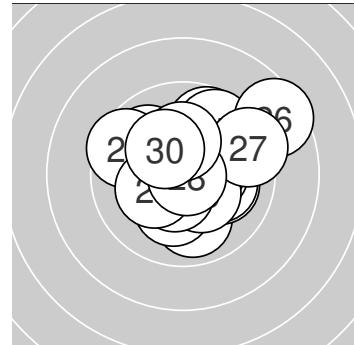

Serie 1: 104.2 (98)

10.5* ←	9.9 ↓	10.8* ↗	10.9* ↖	10.1 →
10.1 →	9.7 ↗	10.8* →	10.6* ↗	10.8* ↗

beste Teiler: 18.9 (4.), 28.0 (8.), 42.0 (3.)
 Trefferlage: 0.62 mm rechts, 0.00 mm
 Streuwert: 1.14, horizontal: 0.98, vertikal: 1.28

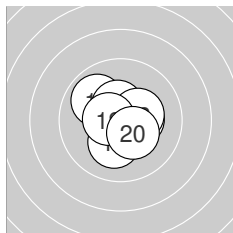

Serie 2: 104.4 (99)

10.8* ↓	10.7* ↓	10.7* ↗	9.9 ↖	10.4* →
10.2* ↓	10.5* ↑	10.3* →	10.5* ←	10.4* ↘

beste Teiler: 31.9 (11.), 67.3 (12.), 70.0 (13.)
 Trefferlage: 0.08 mm rechts, 0.00 mm
 Streuwert: 1.07, horizontal: 1.10, vertikal: 1.04

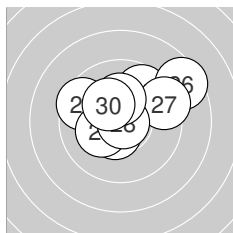

Serie 3: 99.4 (95)

10.5* ↙	10.4* ↑	9.5 ↖	10.2* ↖	9.7 ↗
8.5 ↗	9.3 ↗	10.9* ↘	10.2* ↑	10.2* ↖

beste Teiler: 24.5 (28.), 112.8 (21.), 144.0 (22.)
 Trefferlage: 0.47 mm rechts, 1.15 mm hoch
 Streuwert: 2.02, horizontal: 2.50, vertikal: 1.39



Ergebnis: **313.7** (299)
 Serien: 105.8 104.5 103.4
 Zähler: 29 1 0 0 0 0 0 0 0 0
 Innenzehner: 26
 Weitester: 258 (25.), 240 (13.), 211 (2.)
 beste Teiler: 5.8 (28.), 20.2 (15.), 22.0 (6.)
 Trefferlage: 0.21 mm rechts, 0.18 mm hoch
 Streuwert: 0.99, horizontal: 1.16, vertikal: 0.78

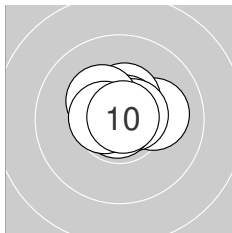
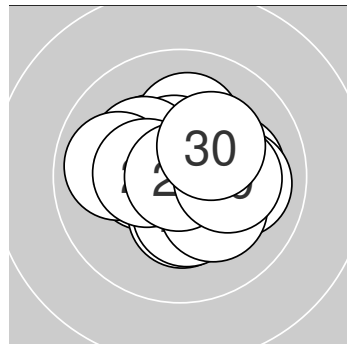

Serie 1: 105.8 (100)

10.7* ↑	10.1 →	10.4* ↑	10.7* ↗	10.6* →
10.9* ↙	10.6* ←	10.3* ↘	10.6* ←	10.9* ↗

beste Teiler: 22.0 (6.), 25.2 (10.), 51.0 (1.)
 Trefferlage: 0.06 mm rechts, 0.43 mm hoch
 Streuwert: 0.74, horizontal: 0.95, vertikal: 0.45

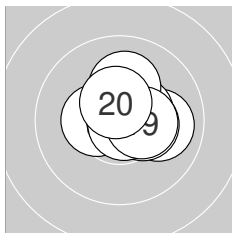

Serie 2: 104.5 (100)

10.5* →	10.4* ←	10.0 →	10.5* →	10.9* →
10.1 ↑	10.4* →	10.8* ↘	10.4* →	10.5* ↑

beste Teiler: 20.2 (15.), 36.7 (18.), 107.6 (11.)
 Trefferlage: 0.65 mm rechts, 0.27 mm hoch
 Streuwert: 0.92, horizontal: 1.06, vertikal: 0.75

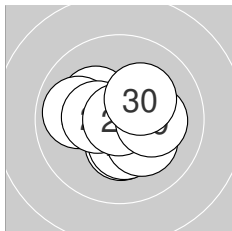

Serie 3: 103.4 (99)

10.8* ←	10.3* ↓	10.2* ↘	10.3* ↓	9.9 ←
10.4* ←	10.2* ↘	10.9* ↙	10.2* →	10.2* ↗

beste Teiler: 5.8 (28.), 43.3 (21.), 137.6 (26.)
 Trefferlage: 0.08 mm links, 0.15 mm tief
 Streuwert: 1.23, horizontal: 1.42, vertikal: 1.00



Ergebnis: 316.8 (300)
Serien: 106.3 104.7 105.8
Zähler: 30 0 0 0 0 0 0 0 0 0
Innenzehner: 28
Weiteste: 222 (13.), 217 (15.), 178 (19.)
beste Teiler: 24.0 (30.), 30.8 (22.), 33.0 (6.)
Trefferlage: 0.16 mm rechts, 0.08 mm tief
Streuwert: 0.79, horizontal: 0.86, vertikal: 0.72

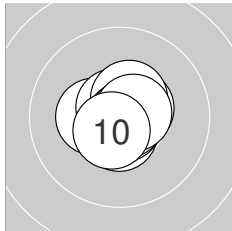
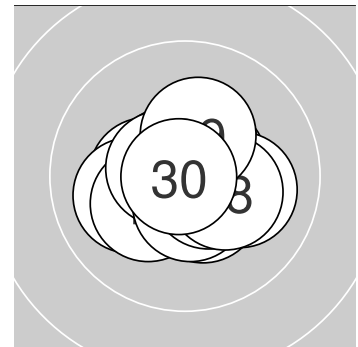

Serie 1: 106.3 (100)

10.6* ↓	10.4* ←	10.5* ↗	10.7* ↖	10.5* ↗
10.8* ↘	10.8* ↘	10.8* →	10.6* →	10.6* ↙

beste Teiler: 33.0 (6.), 41.4 (8.), 41.8 (7.)
Trefferlage: 0.08 mm rechts, 0.01 mm hoch
Streuwert: 0.66, horizontal: 0.71, vertikal: 0.61

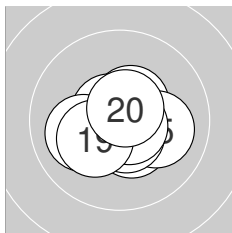

Serie 2: 104.7 (100)

10.5* ↗	10.7* ↖	10.1 ←	10.4* ↓	10.1 →
10.8* ↘	10.6* ↓	10.7* ↘	10.2* ↙	10.6* ↗

beste Teiler: 36.7 (16.), 65.5 (18.), 72.6 (12.)
Trefferlage: 0.08 mm rechts, 0.28 mm tief
Streuwert: 0.99, horizontal: 1.19, vertikal: 0.74

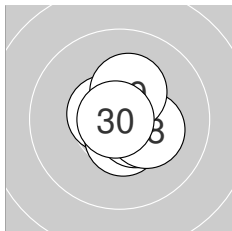

Serie 3: 105.8 (100)

10.5* ↗	10.8* ↓	10.8* ↗	10.6* ↖	10.6* ↓
10.5* ↓	10.5* ↘	10.3* ↘	10.3* ↗	10.9* ←

beste Teiler: 24.0 (30.), 30.8 (22.), 46.8 (23.)
Trefferlage: 0.32 mm rechts, 0.01 mm hoch
Streuwert: 0.74, horizontal: 0.64, vertikal: 0.84



Ergebnis: 314.2 (299)
Serien: 105.3 104.0 104.9
Zähler: 29 1 0 0 0 0 0 0 0 0
Innenzehner: 25
Weiteste: 301 (7.), 227 (13.), 223 (11.)
beste Teiler: 15.6 (8.), 27.4 (1.), 37.4 (6.)
Trefferlage: 0.06 mm links, 0.04 mm hoch
Streuwert: 1.00, horizontal: 1.04, vertikal: 0.96

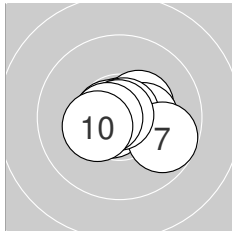
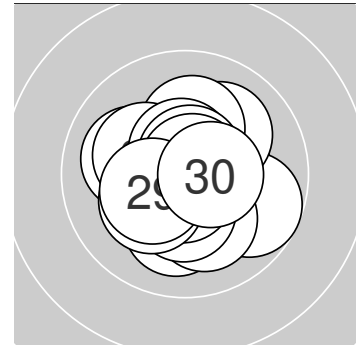

Serie 1: 105.3 (99)

10.8* ↑	10.7* ←	10.4* ↗	10.4* →	10.7* ↙
10.8* ↗	9.7 ↘	10.9* ↘	10.6* ←	10.3* ↙

beste Teiler: 15.6 (8.), 27.4 (1.), 37.4 (6.)
Trefferlage: 0.23 mm rechts, 0.07 mm tief
Streuwert: 0.96, horizontal: 1.25, vertikal: 0.55

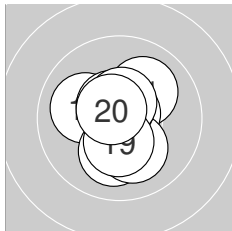

Serie 2: 104.0 (100)

10.1 ↗	10.8* ↗	10.0 ←	10.1 ↓	10.6* ↘
10.1 ↓	10.7* ↑	10.6* ↑	10.4* ↓	10.6* ↘

beste Teiler: 46.8 (12.), 75.0 (17.), 76.4 (20.)
Trefferlage: 0.08 mm links, 0.02 mm hoch
Streuwert: 1.16, horizontal: 0.96, vertikal: 1.33

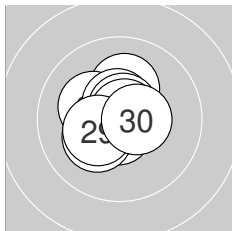

Serie 3: 104.9 (100)

10.7* ↓	10.2* ↑	10.7* ↙	10.2* ↘	10.6* ↑
10.7* ↑	10.2* ↙	10.8* ↗	10.3* ↙	10.5* →

beste Teiler: 44.5 (28.), 51.8 (23.), 67.8 (21.)
Trefferlage: 0.33 mm links, 0.19 mm hoch
Streuwert: 0.92, horizontal: 0.90, vertikal: 0.93



Ergebnis: **312.7** (298)
Serien: 104.8 104.9 103.0
Zähler: 28 2 0 0 0 0 0 0 0 0 0
Innenzehner: 25
Weiteste: 341 (26.), 291 (27.), 249 (11.)
beste Teiler: 0.0 (18.), 23.0 (6.), 28.4 (14.)
Trefferlage: 0.00 mm , 0.03 mm hoch
Streuwert: 1.11, horizontal: 1.35, vertikal: 0.79

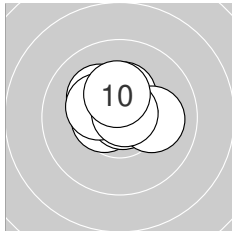
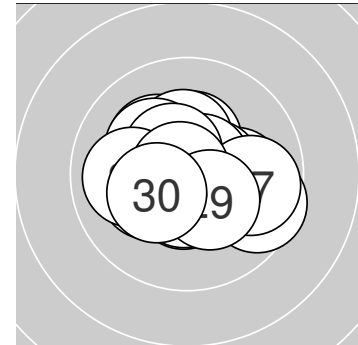

Serie 1: 104.8 (100)

10.6* ↖	10.7* ↖	10.4* ↑	10.2* ↖	10.5* ←
10.9* →	10.1 →	10.3* ↖	10.8* ↗	10.3* ↑

beste Teiler: 23.0 (6.), 43.6 (9.), 68.0 (2.)
Trefferlage: 0.20 mm links, 0.62 mm hoch
Streuwert: 0.87, horizontal: 1.05, vertikal: 0.66

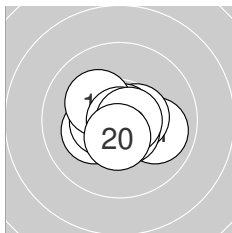

Serie 2: 104.9 (100)

10.0 →	10.5* →	10.6* ↘	10.8* ↗	10.2* ←
10.5* ←	10.2* ↖	10.9* →	10.7* →	10.5* ↓

beste Teiler: 0.0 (18.), 28.4 (14.), 63.0 (19.)
Trefferlage: 0.03 mm rechts, 0.18 mm tief
Streuwert: 0.99, horizontal: 1.24, vertikal: 0.66

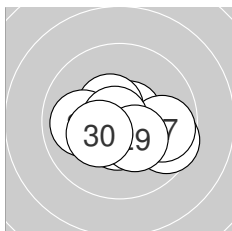

Serie 3: 103.0 (98)

10.6* ←	10.5* ↓	10.6* ↗	10.5* ↖	10.0 ←
9.6 →	9.8 →	10.8* ↖	10.3* ↘	10.3* ↗

beste Teiler: 33.8 (28.), 77.0 (23.), 87.2 (21.)
Trefferlage: 0.18 mm rechts, 0.33 mm tief
Streuwert: 1.37, horizontal: 1.78, vertikal: 0.76



Ergebnis: 309.8 (296)
Serien: 103.3 104.0 102.5
Zähler: 26 4 0 0 0 0 0 0 0 0
Innenzehner: 23
Weiteste: 334 (29.), 284 (1.), 283 (11.)
beste Teiler: 35.2 (12.), 48.8 (26.), 72.0 (15.)
Trefferlage: 0.43 mm links, 0.30 mm hoch
Streuwert: 1.19, horizontal: 1.40, vertikal: 0.92

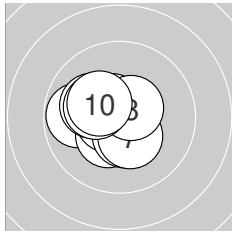
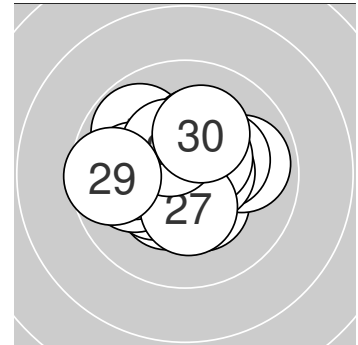

Serie 1: 103.3 (99)

9.8 ←	10.4* ↙	10.6* ←	10.4* ↓	10.6* ↘
10.1 ↖	10.4* ↓	10.5* ↗	10.2* ↖	10.3* ↘

beste Teiler: 81.7 (3.), 94.0 (5.), 101.6 (8.)
Trefferlage: 0.80 mm links, 0.00 mm
Streuwert: 1.07, horizontal: 1.19, vertikal: 0.94

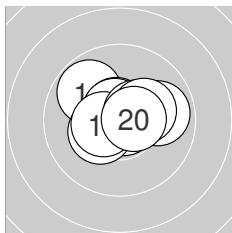

Serie 2: 104.0 (98)

9.8 ↘	10.8* ↘	9.9 →	10.7* ↖	10.7* ↘
10.3* ↙	10.5* ←	10.5* ↗	10.2* ↗	10.6* →

beste Teiler: 35.2 (12.), 72.0 (15.), 74.9 (14.)
Trefferlage: 0.16 mm rechts, 0.37 mm hoch
Streuwert: 1.16, horizontal: 1.46, vertikal: 0.74

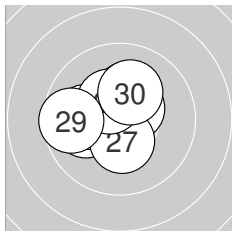

Serie 3: 102.5 (99)

10.5* ↗	10.4* ↑	10.0 ←	10.2* ↑	10.0 ←
10.8* ↘	10.4* ↓	10.4* ↘	9.6 ←	10.2* ↑

beste Teiler: 48.8 (26.), 114.2 (21.), 137.3 (22.)
Trefferlage: 0.65 mm links, 0.54 mm hoch
Streuwert: 1.29, horizontal: 1.49, vertikal: 1.06



Ergebnis: **311.2** (297)
Serien: 103.3 104.3 103.6
Zähler: 27 3 0 0 0 0 0 0 0 0
Innenzehner: 24
Weiteste: 316 (16.), 265 (22.), 263 (8.)
beste Teiler: 7.2 (28.), 28.6 (26.), 34.0 (3.)
Trefferlage: 0.11 mm rechts, 0.41 mm hoch
Streuwert: 1.14, horizontal: 1.17, vertikal: 1.10

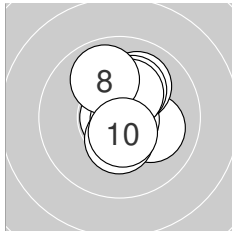
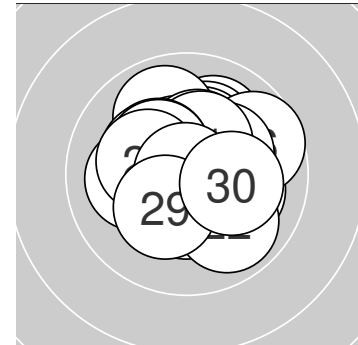

Serie 1: 103.3 (99)

10.1 ↘	10.3* ↑	10.8* ←	10.0 ↗	10.8* ↘
10.2* ↗	10.3* ↗	9.9 ↘	10.4* ↓	10.5* ↓

beste Teiler: 34.0 (3.), 37.1 (5.), 101.2 (10.)
Trefferlage: 0.39 mm rechts, 0.60 mm hoch
Streuwert: 1.15, horizontal: 0.82, vertikal: 1.41

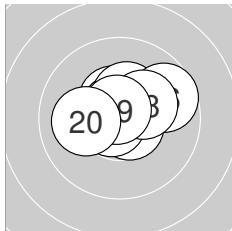

Serie 2: 104.3 (99)

10.6* ↘	10.7* ↑	10.5* ↘	10.7* ↘	10.4* ↑
9.7 ↗	10.7* ↙	10.2* ↗	10.7* ↘	10.1 ←

beste Teiler: 56.7 (17.), 58.1 (19.), 63.9 (14.)
Trefferlage: 0.18 mm rechts, 0.57 mm hoch
Streuwert: 1.06, horizontal: 1.34, vertikal: 0.68

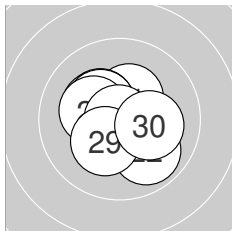

Serie 3: 103.6 (99)

10.4* ↗	9.9 ↘	10.3* ↘	10.3* ↘	10.3* ↘
10.8* ↓	10.2* ↙	10.9* ←	10.3* ↙	10.2* →

beste Teiler: 7.2 (28.), 28.6 (26.), 148.1 (21.)
Trefferlage: 0.24 mm links, 0.06 mm hoch
Streuwert: 1.22, horizontal: 1.32, vertikal: 1.12



Ergebnis: 312.0 (297)
Serien: 105.2 104.0 102.8
Zähler: 27 3 0 0 0 0 0 0 0 0
Innenzehner: 24
Weiteste: 401 (30.), 279 (29.), 257 (16.)
beste Teiler: 25.9 (3.), 33.6 (2.), 42.4 (18.)
Trefferlage: 0.05 mm links, 0.03 mm hoch
Streuwert: 1.15, horizontal: 1.00, vertikal: 1.29

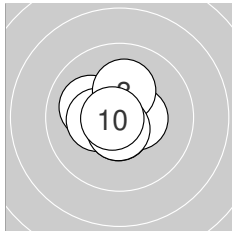
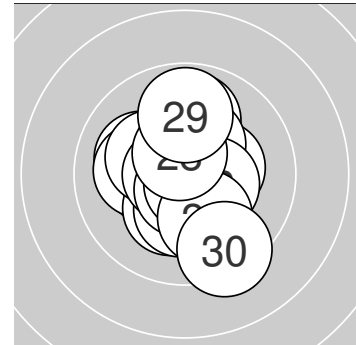

Serie 1: 105.2 (100)

10.6* ↓	10.8* ↘	10.9* ←	10.5* ↖	10.1 ↖
10.5* →	10.3* ←	10.2* ↑	10.6* ↓	10.7* ←

beste Teiler: 25.9 (3.), 33.6 (2.), 52.7 (10.)
Trefferlage: 0.41 mm links, 0.13 mm hoch
Streuwert: 0.86, horizontal: 0.92, vertikal: 0.80

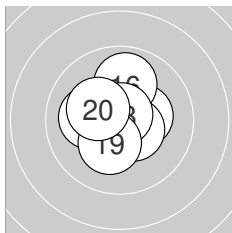

Serie 2: 104.0 (99)

10.1 ←	10.7* ↑	10.6* →	10.5* ↖	10.3* →
9.9 ↑	10.5* ↘	10.8* ↑	10.3* ↓	10.3* ↖

beste Teiler: 42.4 (18.), 61.3 (12.), 97.4 (13.)
Trefferlage: 0.12 mm links, 0.33 mm hoch
Streuwert: 1.11, horizontal: 1.17, vertikal: 1.05

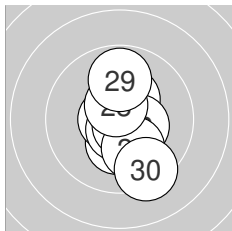

Serie 3: 102.8 (98)

10.3* ↓	10.7* ←	10.3* ↑	10.7* ↓	10.7* ↘
10.4* →	10.1 ↓	10.5* ↑	9.8 ↑	9.3 ↓

beste Teiler: 54.9 (25.), 72.0 (22.), 74.7 (24.)
Trefferlage: 0.37 mm rechts, 0.37 mm tief
Streuwert: 1.41, horizontal: 0.80, vertikal: 1.82



Ergebnis: **313.3** (299)
 Serien: 103.9 103.5 105.9
 Zähler: 29 1 0 0 0 0 0 0 0 0
 Innenzehner: 26
 Weitester: 360 (6.), 243 (11.), 215 (20.)
 beste Teiler: 30.0 (22.), 31.1 (25.), 39.8 (14.)
 Trefferlage: 0.16 mm links, 0.12 mm tief
 Streuwert: 1.04, horizontal: 1.14, vertikal: 0.94

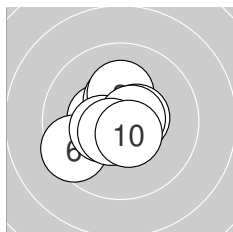
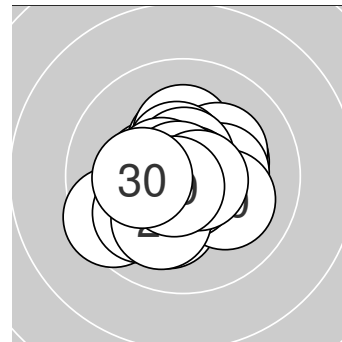

Serie 1: 103.9 (99)

10.4* ←	10.4* ↑	10.2* ↑	10.5* →	10.7* ↘
9.5 ↙	10.4* ↙	10.6* →	10.6* ↙	10.6* ↘

beste Teiler: 54.6 (5.), 77.8 (8.), 95.5 (9.)
 Trefferlage: 0.37 mm links, 0.03 mm tief
 Streuwert: 1.17, horizontal: 1.25, vertikal: 1.08

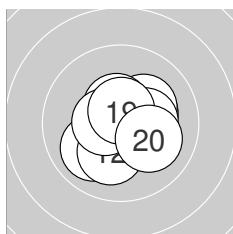

Serie 2: 103.5 (100)

10.0 ↙	10.2* ↓	10.3* →	10.8* ↑	10.2* ↗
10.5* ↑	10.3* →	10.5* ←	10.6* ↑	10.1 ↘

beste Teiler: 39.8 (14.), 83.1 (19.), 103.3 (18.)
 Trefferlage: 0.28 mm rechts, 0.03 mm tief
 Streuwert: 1.20, horizontal: 1.30, vertikal: 1.10

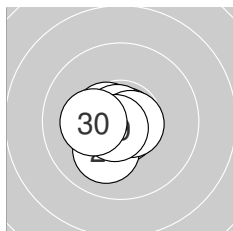

Serie 3: 105.9 (100)

10.5* ↖	10.8* →	10.7* ↓	10.6* ←	10.8* ↖
10.8* ↓	10.1 ↙	10.7* →	10.7* ↙	10.2* ←

beste Teiler: 30.0 (22.), 31.1 (25.), 44.9 (26.)
 Trefferlage: 0.40 mm links, 0.31 mm tief
 Streuwert: 0.70, horizontal: 0.75, vertikal: 0.64



Ergebnis: 310.8 (297)
Serien: 104.3 102.9 103.6
Zähler: 27 3 0 0 0 0 0 0 0 0 0
Innenzehner: 25
Weiteste: 383 (21.), 299 (3.), 289 (7.)
beste Teiler: 32.5 (9.), 34.9 (6.), 50.2 (24.)
Trefferlage: 0.16 mm links, 0.25 mm hoch
Streuwert: 1.19, horizontal: 1.38, vertikal: 0.95

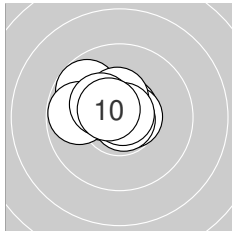
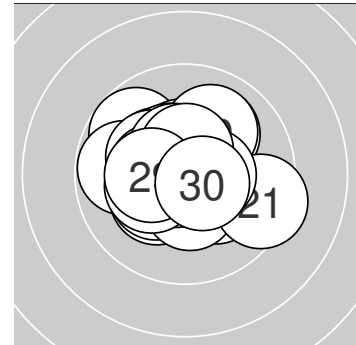

Serie 1: 104.3 (98)

10.7* ↗	10.6* →	9.8 ↘	10.4* ↑	10.5* ↖
10.8* ↘	9.8 ←	10.3* ↖	10.8* ↗	10.6* ↘

beste Teiler: 32.5 (9.), 34.9 (6.), 73.1 (1.)
Trefferlage: 0.67 mm links, 0.62 mm hoch
Streuwert: 0.98, horizontal: 1.24, vertikal: 0.62

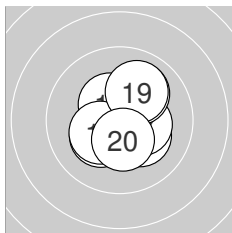

Serie 2: 102.9 (100)

10.5* ↑	10.5* ↘	10.3* ↗	10.4* ↘	10.3* ↖
10.2* ↘	10.3* →	10.0 ↗	10.0 ↗	10.4* ↓

beste Teiler: 101.0 (12.), 108.2 (11.), 133.4 (14.)
Trefferlage: 0.31 mm rechts, 0.09 mm hoch
Streuwert: 1.23, horizontal: 1.14, vertikal: 1.31

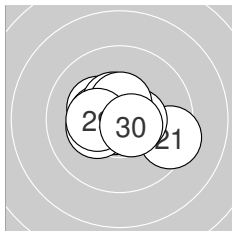

Serie 3: 103.6 (99)

9.4 ↘	10.5* →	10.3* ↘	10.8* ↖	10.4* ←
10.3* ←	10.5* ↖	10.5* ↑	10.3* ←	10.6* ↘

beste Teiler: 50.2 (24.), 93.9 (30.), 112.1 (28.)
Trefferlage: 0.13 mm links, 0.05 mm hoch
Streuwert: 1.29, horizontal: 1.65, vertikal: 0.78



Ergebnis: **316.2** (300)
Serien: 105.5 105.8 104.9
Zähler: 30 0 0 0 0 0 0 0 0 0
Innenzehner: 29
Weiteste: 213 (4.), 190 (30.), 175 (17.)
beste Teiler: 17.2 (7.), 39.0 (27.), 42.6 (19.)
Trefferlage: 0.12 mm rechts, 0.02 mm tief
Streuwert: 0.81, horizontal: 0.95, vertikal: 0.64

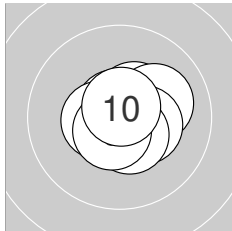
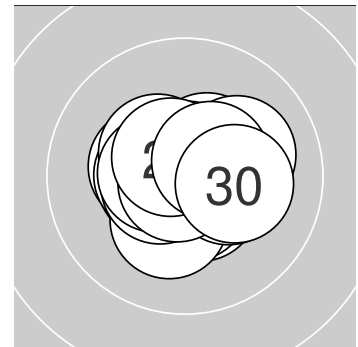

Serie 1: 105.5 (100)

10.5* ↗	10.6* →	10.7* ↘	10.1 →	10.5* ←
10.4* →	10.9* ↘	10.5* ↓	10.6* ↓	10.7* ↑

beste Teiler: 17.2 (7.), 54.2 (3.), 60.6 (10.)
Trefferlage: 0.39 mm rechts, 0.02 mm hoch
Streuwert: 0.79, horizontal: 0.90, vertikal: 0.66

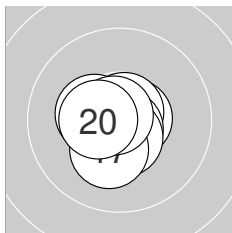

Serie 2: 105.8 (100)

10.6* →	10.7* ↗	10.7* ←	10.5* ↓	10.7* ↓
10.6* ↓	10.3* ↓	10.4* ←	10.8* ↘	10.5* ←

beste Teiler: 42.6 (19.), 54.2 (12.), 55.4 (15.)
Trefferlage: 0.28 mm links, 0.29 mm tief
Streuwert: 0.72, horizontal: 0.70, vertikal: 0.74

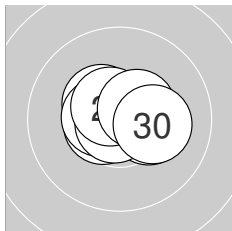

Serie 3: 104.9 (100)

10.4* ↘	10.3* →	10.5* →	10.6* ←	10.5* ←
10.5* ↗	10.8* ↗	10.6* ↘	10.5* ↗	10.2* →

beste Teiler: 39.0 (27.), 90.0 (28.), 100.5 (24.)
Trefferlage: 0.26 mm rechts, 0.18 mm hoch
Streuwert: 0.89, horizontal: 1.16, vertikal: 0.47



Ergebnis: 308.7 (294)
Serien: 102.5 103.0 103.2
Zähler: 24 6 0 0 0 0 0 0 0 0
Innenzehner: 22
Weiteste: 405 (1.), 305 (21.), 289 (11.)
beste Teiler: 45.1 (16.), 51.4 (19.), 70.4 (27.)
Trefferlage: 0.40 mm rechts, 0.55 mm tief
Streuwert: 1.25, horizontal: 1.42, vertikal: 1.05

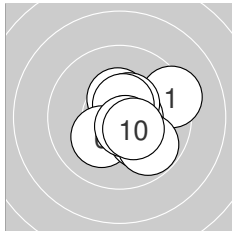
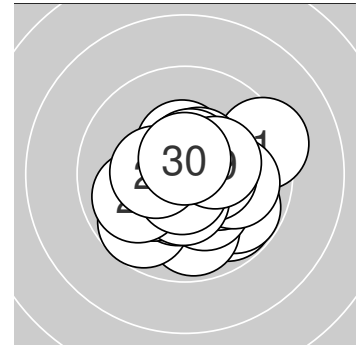

Serie 1: 102.5 (98)

9.3 →	10.4* ↑	10.6* →	10.5* ↗	10.6* ↑
10.2* ↙	10.1 ↘	10.6* ↘	9.8 ↘	10.4* ↘

beste Teiler: 78.2 (8.), 93.0 (3.), 96.8 (5.)
Trefferlage: 0.91 mm rechts, 0.16 mm tief
Streuwert: 1.33, horizontal: 1.36, vertikal: 1.29

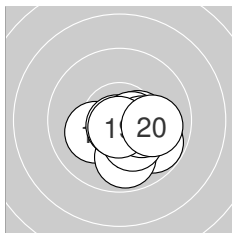

Serie 2: 103.0 (98)

9.8 ↘	10.4* →	10.2* ↙	9.9 ↓	10.3* ↘
10.8* ↙	10.6* →	10.3* →	10.7* ↓	10.0 →

beste Teiler: 45.1 (16.), 51.4 (19.), 90.6 (17.)
Trefferlage: 0.79 mm rechts, 0.87 mm tief
Streuwert: 1.07, horizontal: 1.27, vertikal: 0.82

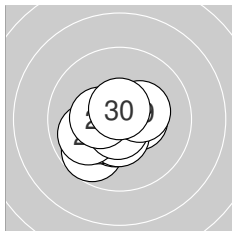

Serie 3: 103.2 (98)

9.7 ↙	10.4* →	10.4* ↓	10.2* ↙	10.5* ↓
9.9 ↙	10.7* ↓	10.4* ←	10.3* →	10.7* ↑

beste Teiler: 70.4 (27.), 75.0 (30.), 122.2 (25.)
Trefferlage: 0.50 mm links, 0.61 mm tief
Streuwert: 1.13, horizontal: 1.28, vertikal: 0.95



Ergebnis: 303.4 (291)
Serien: 100.2 100.9 102.3
Zähler: 22 7 1 0 0 0 0 0 0 0
Innenzehner: 16
Weiteste: 548 (19.), 446 (10.), 431 (11.)
beste Teiler: 21.2 (22.), 27.6 (13.), 49.6 (25.)
Trefferlage: 0.08 mm links, 0.89 mm hoch
Streuwert: 1.64, horizontal: 1.88, vertikal: 1.37

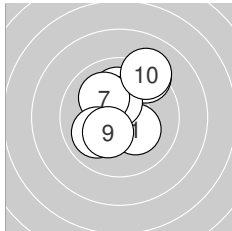
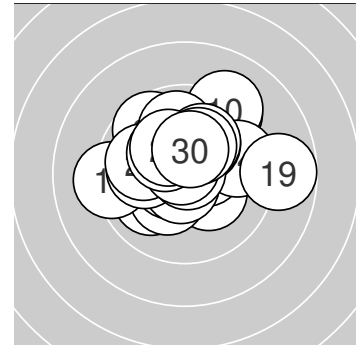

Serie 1: 100.2 (98)

10.3* ↘	10.3* ↙	10.2* ↑	9.3 ↗	10.1 ↑
10.4* ↑	10.1 ↘	10.0 ↙	10.3* ↙	9.2 ↗

beste Teiler: 136.1 (6.), 164.8 (2.), 166.8 (9.)
Trefferlage: 0.02 mm links, 0.97 mm hoch
Streuwert: 1.78, horizontal: 1.54, vertikal: 2.00

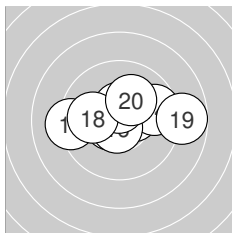

Serie 2: 100.9 (96)

9.2 ←	10.5* →	10.8* ↙	9.7 →	10.6* ↙
10.7* ↓	10.5* ↑	10.0 ←	8.8 →	10.1 ↗

beste Teiler: 27.6 (13.), 68.9 (16.), 92.6 (15.)
Trefferlage: 0.27 mm rechts, 0.28 mm hoch
Streuwert: 1.99, horizontal: 2.71, vertikal: 0.77

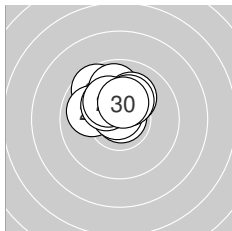

Serie 3: 102.3 (97)

9.6 ↘	10.9* ↗	9.9 ←	9.9 ↑	10.8* ↘
10.3* ↘	10.1 ↗	10.2* ↘	10.2* ↗	10.4* ↑

beste Teiler: 21.2 (22.), 49.6 (25.), 149.2 (30.)
Trefferlage: 0.50 mm links, 1.43 mm hoch
Streuwert: 1.00, horizontal: 1.14, vertikal: 0.83

