

Ergebnis: **305.6** (293)
 Serien: 101.7 102.1 101.8
 Zähler: 23 7 0 0 0 0 0 0 0 0
 Innenzehner: 15
 Weitester: 398 (22.), 377 (21.), 293 (16.)
 beste Teiler: 43.6 (26.), 56.2 (23.), 60.8 (30.)
 Trefferlage: 0.40 mm links, 0.01 mm tief
 Streuwert: 1.46, horizontal: 1.68, vertikal: 1.21

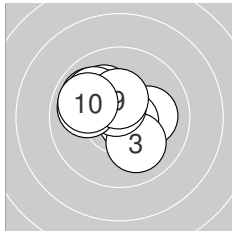
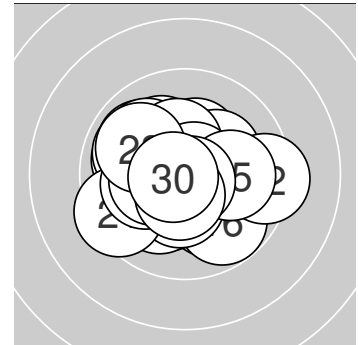

Serie 1: 101.7 (97)

10.1 →	10.7* ↘	10.1 ↘	10.1 ↖	9.9 ↖
10.6* ↑	10.0 ↖	9.9 ↖	10.4* ↑	9.9 ↖

beste Teiler: 73.4 (2.), 85.7 (6.), 138.3 (9.)
 Trefferlage: 0.63 mm links, 0.65 mm hoch
 Streuwert: 1.38, horizontal: 1.62, vertikal: 1.10

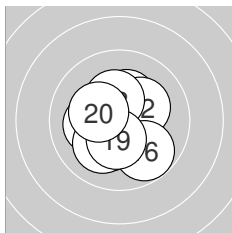

Serie 2: 102.1 (99)

10.3* ↑	10.2* ↗	10.2* ↓	10.4* ↓	10.1 ←
9.8 ↘	10.1 ↓	10.3* ↑	10.4* ↓	10.3* ↖

beste Teiler: 144.1 (19.), 146.3 (14.), 156.9 (18.)
 Trefferlage: 0.29 mm links, 0.40 mm tief
 Streuwert: 1.36, horizontal: 1.27, vertikal: 1.45

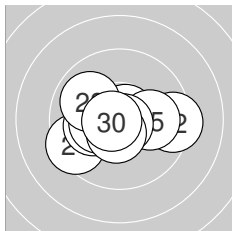

Serie 3: 101.8 (97)

9.4 ↖	9.4 →	10.7* ↗	10.1 ←	10.0 →
10.8* ↘	10.3* ←	9.9 ↖	10.5* ↓	10.7* ←

beste Teiler: 43.6 (26.), 56.2 (23.), 60.8 (30.)
 Trefferlage: 0.29 mm links, 0.28 mm tief
 Streuwert: 1.65, horizontal: 2.18, vertikal: 0.83



Ergebnis: 308.5 (293)
Serien: 103.5 103.1 101.9
Zähler: 23 7 0 0 0 0 0 0 0 0
Innenzehner: 19
Weiteste: 390 (15.), 374 (30.), 305 (22.)
beste Teiler: 22.0 (24.), 26.4 (12.), 46.3 (17.)
Trefferlage: 0.14 mm rechts, 0.12 mm hoch
Streuwert: 1.40, horizontal: 1.75, vertikal: 0.93

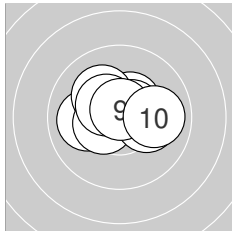
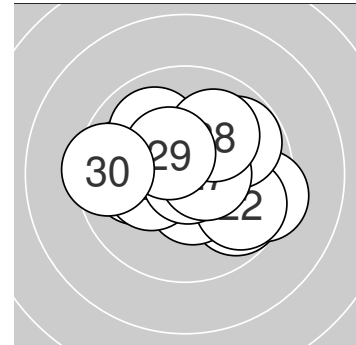

Serie 1: 103.5 (99)

10.4* ↗	10.7* ↘	10.0 ←	10.1 ↘	10.5* ←
10.6* ↗	10.2* →	10.4* ↘	10.7* ↑	9.9 →

beste Teiler: 57.5 (9.), 58.4 (2.), 99.8 (6.)
Trefferlage: 0.00 mm , 0.39 mm hoch
Streuwert: 1.17, horizontal: 1.53, vertikal: 0.65

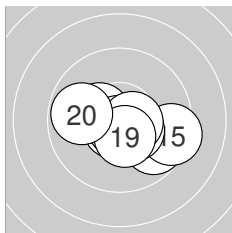

Serie 2: 103.1 (97)

9.7 ↘	10.8* ↓	10.7* ↙	10.3* ←	9.4 →
10.5* ↘	10.8* ↓	10.6* →	10.5* ↓	9.8 ←

beste Teiler: 26.4 (12.), 46.3 (17.), 69.0 (13.)
Trefferlage: 0.37 mm rechts, 0.51 mm tief
Streuwert: 1.40, horizontal: 1.85, vertikal: 0.70

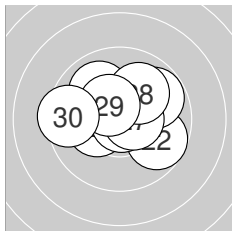

Serie 3: 101.9 (97)

10.3* ←	9.7 ↘	10.7* →	10.9* ↘	10.0 ↘
9.8 ↗	10.6* →	10.0 ↗	10.4* ↘	9.5 ←

beste Teiler: 22.0 (24.), 63.1 (23.), 99.0 (27.)
Trefferlage: 0.06 mm rechts, 0.47 mm hoch
Streuwert: 1.61, horizontal: 2.00, vertikal: 1.10



LG Mixed

StandNr: 66

Einwaller, Dominic #464**Junioren**

Wertung

StartNr: 536

31.03.2023 13:02

Tirol / Tirol 2

Ergebnis: **309.6** (294)
 Serien: 103.8 103.5 102.3
 Zähler: 24 6 0 0 0 0 0 0 0 0
 Innenzehner: 22
 Weitesten: 311 (27.), 274 (23.), 269 (6.)
 beste Teiler: 5.0 (8.), 40.1 (11.), 54.4 (14.)
 Trefferlage: 0.06 mm links, 0.17 mm hoch
 Streuwert: 1.26, horizontal: 1.40, vertikal: 1.10

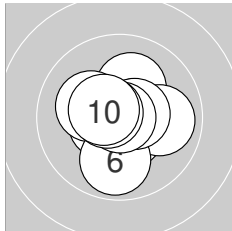
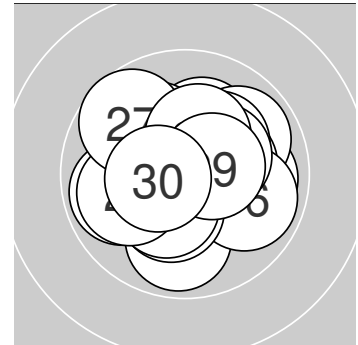
**Serie 1: 103.8 (98)**

10.5* ←	10.2* ↑	10.2* ↖	10.5* ↓	9.9 →
9.9 ↓	10.6* →	10.9* →	10.6* ↖	10.5* ↖

beste Teiler: 5.0 (8.), 81.3 (9.), 97.2 (7.)
 Trefferlage: 0.00 mm , 0.07 mm tief
 Streuwert: 1.21, horizontal: 1.25, vertikal: 1.18

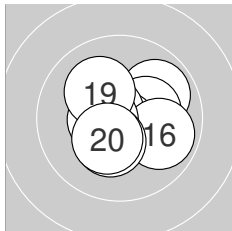
**Serie 2: 103.5 (98)**

10.8* →	9.9 ↗	10.3* →	10.7* ↓	10.6* ↖
9.9 →	10.5* ←	10.3* ↓	10.1 ↖	10.4* ↙

beste Teiler: 40.1 (11.), 54.4 (14.), 83.3 (15.)
 Trefferlage: 0.25 mm rechts, 0.04 mm tief
 Streuwert: 1.25, horizontal: 1.40, vertikal: 1.07

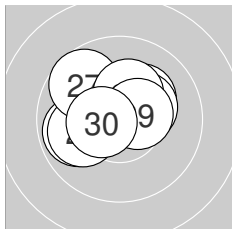
**Serie 3: 102.3 (98)**

10.2* ↗	10.3* ↗	9.9 ←	10.0 ←	10.4* ↑
10.5* ↖	9.7 ↖	10.3* ↑	10.5* →	10.5* ←

beste Teiler: 114.4 (26.), 115.5 (30.), 118.6 (29.)
 Trefferlage: 0.45 mm links, 0.65 mm hoch
 Streuwert: 1.32, horizontal: 1.58, vertikal: 0.99



Ergebnis: 307.9 (293)
Serien: 103.8 104.6 99.5
Zähler: 23 7 0 0 0 0 0 0 0 0
Innenzehner: 20
Weiteste: 456 (26.), 428 (22.), 348 (8.)
beste Teiler: 12.0 (20.), 33.5 (12.), 46.6 (4.)
Trefferlage: 0.71 mm links, 0.07 mm hoch
Streuwert: 1.43, horizontal: 1.25, vertikal: 1.59

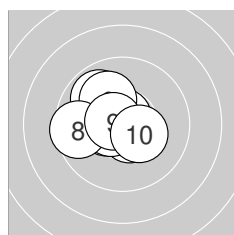
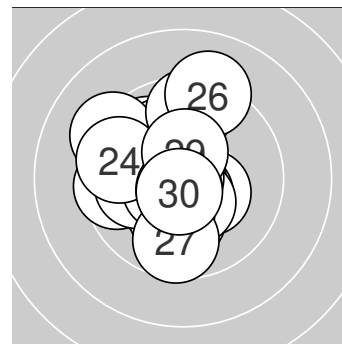

Serie 1: 103.8 (98)

10.4* ←	10.7* ↑	9.9 ↘	10.8* ↙	10.6* ↘
10.1 ↘	10.6* ←	9.6 ←	10.7* ←	10.4* ↘

beste Teiler: 46.6 (4.), 54.0 (2.), 75.5 (9.)
Trefferlage: 0.78 mm links, 0.19 mm hoch
Streuwert: 1.17, horizontal: 1.31, vertikal: 1.01

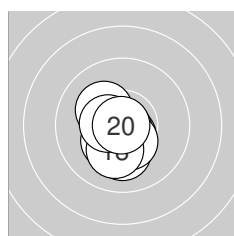

Serie 2: 104.6 (100)

10.6* ↘	10.8* ↓	10.6* ←	10.2* ↘	10.1 ↓
10.3* ↙	10.4* ↘	10.2* ↓	10.5* ←	10.9* ←

beste Teiler: 12.0 (20.), 33.5 (12.), 91.2 (11.)
Trefferlage: 0.43 mm links, 0.66 mm tief
Streuwert: 0.85, horizontal: 0.69, vertikal: 1.00

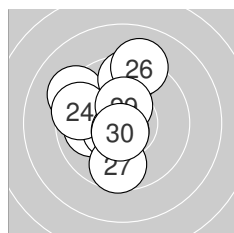

Serie 3: 99.5 (95)

10.0 ←	9.2 ↘	10.5* ←	9.6 ←	9.6 ↑
9.1 ↑	9.7 ↓	10.7* ↓	10.4* ↑	10.7* ↓

beste Teiler: 61.3 (28.), 73.4 (30.), 105.6 (23.)
Trefferlage: 0.93 mm links, 0.69 mm hoch
Streuwert: 1.97, horizontal: 1.64, vertikal: 2.25

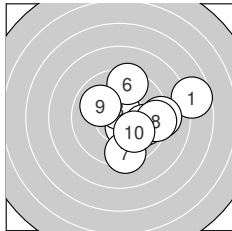
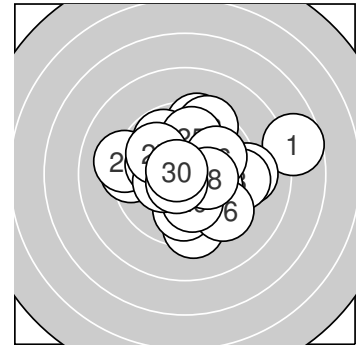

Ergebnis: **295.9** (283)
 Serien: 96.1 99.1 100.7
 Zähler: 15 14 0 1 0 0 0 0 0 0
 Innenzehner: 9
 Weitestе: 816 (1.), 452 (5.), 448 (21.)
 beste Teiler: 65.0 (30.), 85.5 (29.), 91.1 (3.)
 Trefferlage: 0.60 mm rechts, 0.24 mm hoch
 Streuwert: 2.18, horizontal: 2.49, vertikal: 1.82

**Serie 1: 96.1 (92)**

7.7 →	10.5* ↘	10.6* ↑	9.8 →	9.1 →
9.5 ↑	9.4 ↓	9.4 →	10.0 ↖	10.1 ↘

beste Teiler: 91.1 (3.), 125.3 (2.), 223.4 (10.)
 Trefferlage: 2.06 mm rechts, 0.02 mm hoch
 Streuwert: 2.48, horizontal: 2.82, vertikal: 2.10

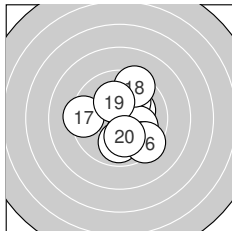
**Serie 2: 99.1 (96)**

10.3* ↘	10.2* →	10.1 ↗	9.9 ↓	10.1 →
9.4 ↘	9.4 ←	9.4 ↗	10.2* ↖	10.1 ↓

beste Teiler: 153.8 (11.), 188.2 (12.), 188.7 (19.)
 Trefferlage: 0.60 mm rechts, 0.12 mm tief
 Streuwert: 1.98, horizontal: 1.87, vertikal: 2.08

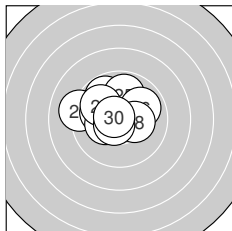
**Serie 3: 100.7 (95)**

9.2 ←	9.8 ↖	10.1 ←	10.3* ←	9.9 ↑
9.9 →	9.9 ↖	10.3* →	10.6* ↖	10.7* ↖

beste Teiler: 65.0 (30.), 85.5 (29.), 164.7 (24.)
 Trefferlage: 0.85 mm links, 0.83 mm hoch
 Streuwert: 1.61, horizontal: 1.95, vertikal: 1.16



Ergebnis: 299.4 (284)
Serien: 98.7 99.5 101.2
Zähler: 16 12 2 0 0 0 0 0 0 0
Innenzehner: 14
Weiteste: 636 (16.), 549 (3.), 387 (30.)
beste Teiler: 27.0 (29.), 46.8 (17.), 63.9 (24.)
Trefferlage: 0.64 mm rechts, 0.33 mm tief
Streuwert: 1.95, horizontal: 2.02, vertikal: 1.89

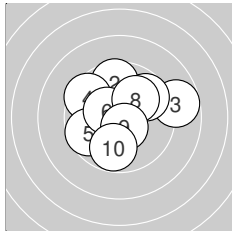
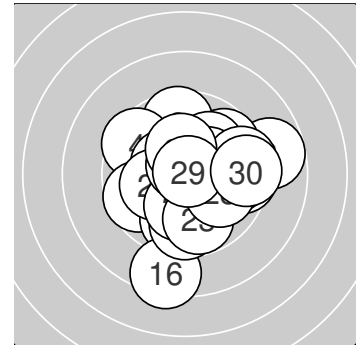

Serie 1: 98.7 (93)

10.7* ↑	9.6 ↑	8.8 →	9.5 ↖	9.7 ↙
10.4* ↖	9.7 ↗	10.0 ↗	10.5* ↓	9.8 ↓

beste Teiler: 70.2 (1.), 103.3 (9.), 134.1 (6.)
Trefferlage: 0.15 mm rechts, 0.62 mm hoch
Streuwert: 2.20, horizontal: 2.51, vertikal: 1.84

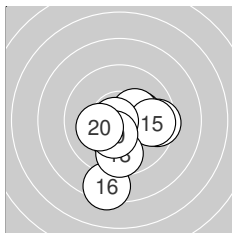

Serie 2: 99.5 (95)

9.5 →	10.2* →	10.3* ↓	10.3* ↗	9.7 →
8.4 ↓	10.8* ←	9.7 ↓	10.4* ↓	10.2* ←

beste Teiler: 46.8 (17.), 145.0 (19.), 161.9 (14.)
Trefferlage: 0.52 mm rechts, 1.23 mm tief
Streuwert: 1.97, horizontal: 1.84, vertikal: 2.09

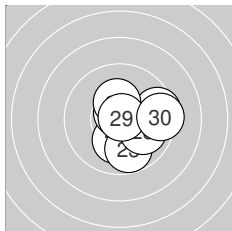

Serie 3: 101.2 (96)

10.6* ↓	10.2* ↓	9.8 ↓	10.7* ↖	9.9 →
9.5 →	10.3* ↑	10.0 ↘	10.8* ↗	9.4 →

beste Teiler: 27.0 (29.), 63.9 (24.), 96.1 (21.)
Trefferlage: 1.27 mm rechts, 0.38 mm tief
Streuwert: 1.50, horizontal: 1.65, vertikal: 1.34



Ergebnis: 307.6 (291)
Serien: 100.0 103.4 104.2
Zähler: 21 9 0 0 0 0 0 0 0 0
Innenzehner: 18
Weiteste: 419 (1.), 369 (4.), 351 (3.)
beste Teiler: 16.2 (29.), 36.8 (12.), 49.7 (18.)
Trefferlage: 0.20 mm rechts, 0.22 mm tief
Streuwert: 1.48, horizontal: 1.63, vertikal: 1.30

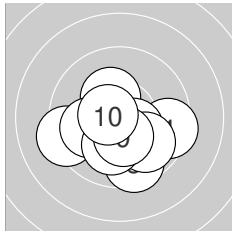
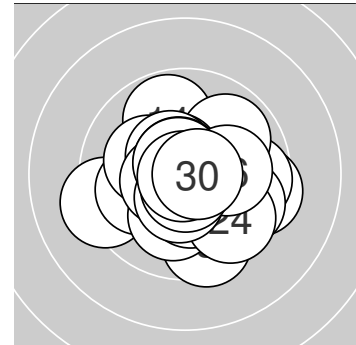

Serie 1: 100.0 (96)

9.3 ←	10.3* ↖	9.5 ↓	9.5 →	10.4* ↘
9.9 ↘	10.0 ←	10.1 ↓	10.4* ↓	10.6* ←

beste Teiler: 88.8 (10.), 131.5 (5.), 144.7 (9.)
Trefferlage: 0.04 mm links, 1.08 mm tief
Streuwert: 1.77, horizontal: 2.13, vertikal: 1.30

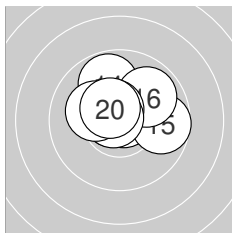

Serie 2: 103.4 (97)

10.4* ↑	10.8* ↗	10.7* ↖	9.8 ↑	9.7 →
9.9 ↗	10.6* ↖	10.8* ↖	10.2* ↖	10.5* ↖

beste Teiler: 36.8 (12.), 49.7 (18.), 59.0 (13.)
Trefferlage: 0.07 mm rechts, 0.85 mm hoch
Streuwert: 1.19, horizontal: 1.44, vertikal: 0.88

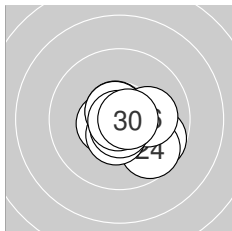

Serie 3: 104.2 (98)

10.5* ←	10.7* ↖	9.7 ↘	9.7 ↘	10.5* ↓
10.1 →	10.7* ↖	10.7* ↓	10.9* ↗	10.7* →

beste Teiler: 16.2 (29.), 62.0 (30.), 63.0 (28.)
Trefferlage: 0.56 mm rechts, 0.45 mm tief
Streuwert: 1.12, horizontal: 1.31, vertikal: 0.90



Ergebnis: 304.7 (291)
Serien: 101.4 104.3 99.0
Zähler: 21 9 0 0 0 0 0 0 0 0 0
Innenzehner: 19
Weiteste: 451 (30.), 418 (10.), 380 (12.)
beste Teiler: 25.8 (16.), 52.2 (13.), 56.8 (14.)
Trefferlage: 0.41 mm links, 0.83 mm hoch
Streuwert: 1.53, horizontal: 1.72, vertikal: 1.30

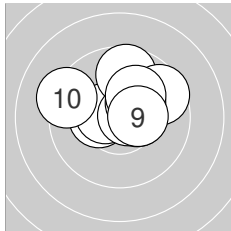
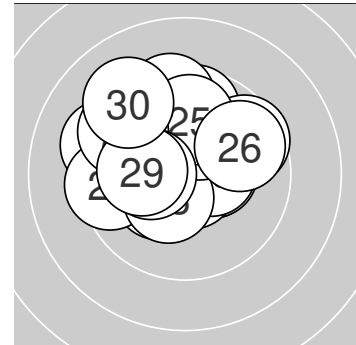

Serie 1: 101.4 (97)

10.3* ←	10.5* ←	10.4* →	9.7 ↑	10.7* →
9.6 ↗	10.3* ↗	10.2* ↗	10.4* →	9.3 ↖

beste Teiler: 62.3 (5.), 109.6 (2.), 130.1 (3.)
Trefferlage: 0.25 mm rechts, 0.94 mm hoch
Streuwert: 1.56, horizontal: 1.94, vertikal: 1.04

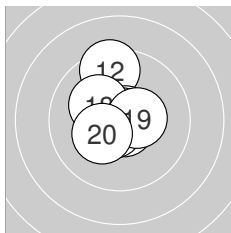

Serie 2: 104.3 (99)

10.4* ↘	9.4 ↑	10.7* ↗	10.7* ↘	10.6* ←
10.9* ↗	10.7* ↘	10.2* ↘	10.4* →	10.3* ↘

beste Teiler: 25.8 (16.), 52.2 (13.), 56.8 (14.)
Trefferlage: 0.38 mm links, 0.39 mm hoch
Streuwert: 1.15, horizontal: 0.91, vertikal: 1.34

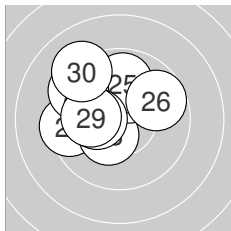

Serie 3: 99.0 (95)

10.4* ↘	9.5 ←	10.4* ↘	10.1 ↑	9.9 ↑
9.7 ↗	9.5 ↘	10.3* ←	10.1 ←	9.1 ↘

beste Teiler: 141.5 (21.), 142.8 (23.), 168.0 (28.)
Trefferlage: 1.11 mm links, 1.14 mm hoch
Streuwert: 1.75, horizontal: 1.97, vertikal: 1.50



Ergebnis: **311.9** (297)
 Serien: 103.7 103.8 104.4
 Zähler: 27 3 0 0 0 0 0 0 0 0 0
 Innenzehner: 23
 Weitester: 328 (11.), 314 (26.), 262 (10.)
 beste Teiler: 28.2 (29.), 32.2 (30.), 55.5 (25.)
 Trefferlage: 0.08 mm rechts, 0.00 mm
 Streuwert: 1.14, horizontal: 1.31, vertikal: 0.93

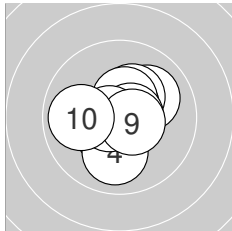
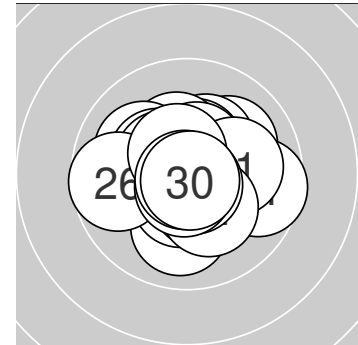

Serie 1: 103.7 (99)

10.0 ↗	10.4* ↘	10.3* ↗	10.0 ↓	10.6* ↗
10.5* ↑	10.7* →	10.7* ←	10.6* →	9.9 ←

beste Teiler: 69.7 (8.), 75.4 (7.), 91.4 (5.)
 Trefferlage: 0.06 mm rechts, 0.09 mm hoch
 Streuwert: 1.21, horizontal: 1.24, vertikal: 1.16

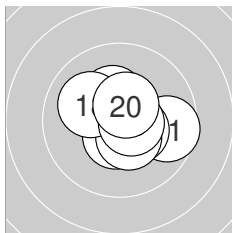

Serie 2: 103.8 (99)

9.6 →	10.4* ↘	10.3* ↑	10.7* ↘	10.7* ↗
10.5* ↓	10.4* ↘	10.1 ↖	10.6* →	10.5* ↑

beste Teiler: 58.6 (14.), 59.5 (15.), 82.2 (19.)
 Trefferlage: 0.45 mm rechts, 0.01 mm tief
 Streuwert: 1.14, horizontal: 1.32, vertikal: 0.94

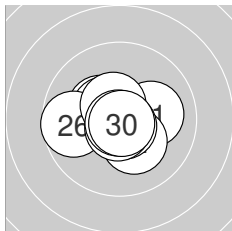

Serie 3: 104.4 (99)

10.1 →	10.4* ↖	10.5* ↖	10.2* ↘	10.7* ↘
9.7 ←	10.5* ↑	10.7* ↓	10.8* ↓	10.8* ↓

beste Teiler: 28.2 (29.), 32.2 (30.), 55.5 (25.)
 Trefferlage: 0.26 mm links, 0.07 mm tief
 Streuwert: 1.12, horizontal: 1.40, vertikal: 0.75



Ergebnis: 309.6 (295)
Serien: 102.9 104.1 102.6
Zähler: 25 5 0 0 0 0 0 0 0 0
Innenzehner: 21
Weiteste: 379 (2.), 346 (9.), 305 (30.)
beste Teiler: 15.8 (8.), 24.4 (22.), 39.8 (3.)
Trefferlage: 0.09 mm links, 0.26 mm hoch
Streuwert: 1.30, horizontal: 1.41, vertikal: 1.18

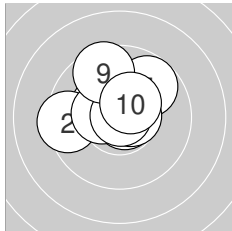
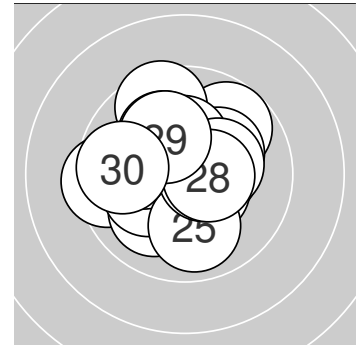

Serie 1: 102.9 (97)

10.3* ↖	9.4 ←	10.8* →	10.7* ↑	9.8 ↗
10.4* ↖	10.6* →	10.9* ↗	9.6 ↘	10.4* ↗

beste Teiler: 15.8 (8.), 39.8 (3.), 74.4 (4.)
Trefferlage: 0.33 mm links, 0.80 mm hoch
Streuwert: 1.40, horizontal: 1.62, vertikal: 1.13

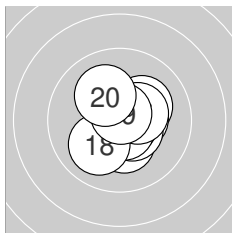

Serie 2: 104.1 (100)

10.3* ↓	10.2* ↗	10.4* →	10.5* ↘	10.7* ↘
10.7* ↓	10.4* ↗	10.0 ↘	10.8* ↑	10.1 ↘

beste Teiler: 50.0 (19.), 62.6 (15.), 73.4 (16.)
Trefferlage: 0.39 mm rechts, 0.11 mm tief
Streuwert: 1.07, horizontal: 1.01, vertikal: 1.12

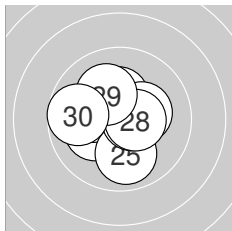

Serie 3: 102.6 (98)

10.2* ↖	10.9* ↘	10.3* ↑	10.1 ↖	9.9 ↓
10.6* →	10.3* →	10.5* →	10.1 ↘	9.7 ←

beste Teiler: 24.4 (22.), 93.1 (26.), 115.2 (28.)
Trefferlage: 0.35 mm links, 0.11 mm hoch
Streuwert: 1.38, horizontal: 1.53, vertikal: 1.21



Ergebnis: 301.7 (288)
Serien: 101.1 101.9 98.7
Zähler: 20 8 2 0 0 0 0 0 0 0 0
Innenzehner: 12
Weiteste: 580 (29.), 561 (24.), 389 (1.)
beste Teiler: 14.5 (17.), 19.0 (18.), 42.1 (10.)
Trefferlage: 0.16 mm links, 0.52 mm hoch
Streuwert: 1.85, horizontal: 1.71, vertikal: 1.99

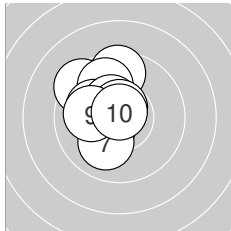
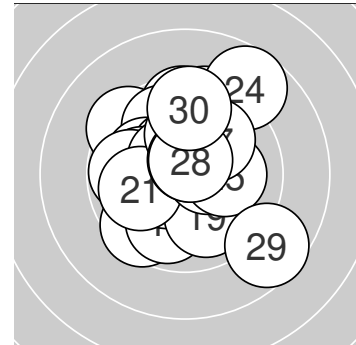

Serie 1: 101.1 (97)

9.4 ↘ 9.5 ↑ 9.8 ↘
 10.5* ↙ 10.0 ↘ 10.6* ↑
beste Teiler: 42.1 (10.), 78.0 (8.), 108.8 (6.)
Trefferlage: 1.13 mm links, 0.93 mm hoch
Streuwert: 1.35, horizontal: 1.02, vertikal: 1.61

10.1 ↖ 10.4* ↘
 10.0 ← 10.8* ↑

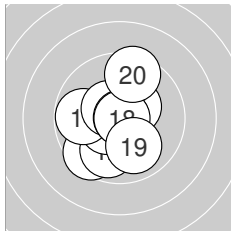

Serie 2: 101.9 (96)

9.5 ↙ 9.9 ↓ 10.5* ↙ 9.8 ← 10.4* ↗
 10.5* ↘ 10.9* → 10.9* → 10.0 ↘ 9.5 ↑
beste Teiler: 14.5 (17.), 19.0 (18.), 114.6 (16.)
Trefferlage: 0.43 mm links, 0.27 mm tief
Streuwert: 1.67, horizontal: 1.42, vertikal: 1.89

10.0 ↖ 10.5* → 10.1 ↑ 8.7 ↗ 10.1 →
 10.6* ↑ 10.0 ↗ 10.6* ↑ 8.6 ↘ 9.5 ↑

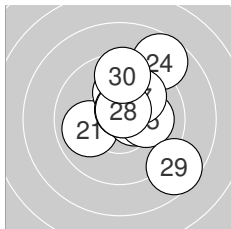

Serie 3: 98.7 (95)

10.0 ↖ 10.5* → 10.1 ↑ 8.7 ↗ 10.1 →
 10.6* ↑ 10.0 ↗ 10.6* ↑ 8.6 ↘ 9.5 ↑
beste Teiler: 80.6 (26.), 80.7 (28.), 120.4 (22.)
Trefferlage: 1.09 mm rechts, 0.90 mm hoch
Streuwert: 2.12, horizontal: 1.88, vertikal: 2.34



Ergebnis: 309.0 (294)
Serien: 104.2 103.3 101.5
Zähler: 24 6 0 0 0 0 0 0 0 0
Innenzehner: 20
Weiteste: 379 (18.), 375 (29.), 368 (7.)
beste Teiler: 17.8 (16.), 18.9 (8.), 33.2 (1.)
Trefferlage: 0.27 mm links, 0.04 mm tief
Streuwert: 1.40, horizontal: 1.51, vertikal: 1.27

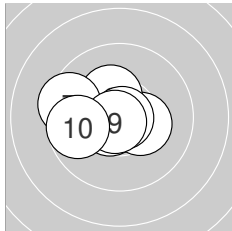
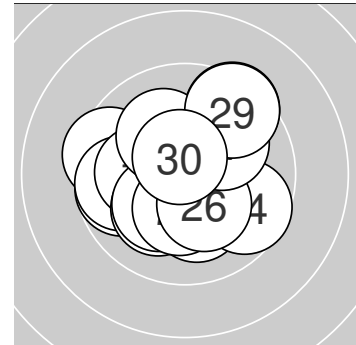

Serie 1: 104.2 (98)

10.8* ↖	10.6* ↙	10.3* →	10.5* ←	10.8* ↖
10.3* ↖	9.5 ←	10.9* →	10.8* ↙	9.7 ←

beste Teiler: 18.9 (8.), 33.2 (1.), 46.6 (9.)
Trefferlage: 0.84 mm links, 0.10 mm hoch
Streuwert: 1.14, horizontal: 1.46, vertikal: 0.68

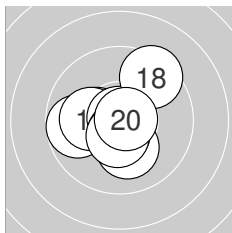

Serie 2: 103.3 (98)

10.2* ↓	10.8* ↓	10.3* ←	9.7 ←	10.1 ←
10.9* ↖	10.6* ↓	9.4 ↗	10.5* ↓	10.8* →

beste Teiler: 17.8 (16.), 43.9 (12.), 45.7 (20.)
Trefferlage: 0.37 mm links, 0.13 mm tief
Streuwert: 1.40, horizontal: 1.48, vertikal: 1.31

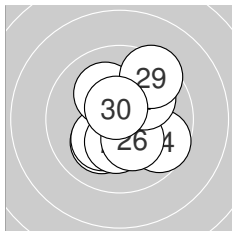

Serie 3: 101.5 (98)

10.1 ↙	10.2* ↙	10.7* ↓	9.7 →	10.3* ↓
10.3* ↓	10.0 ↗	10.1 ↖	9.5 ↗	10.6* ↖

beste Teiler: 59.4 (23.), 84.7 (30.), 162.9 (25.)
Trefferlage: 0.39 mm rechts, 0.10 mm tief
Streuwert: 1.61, horizontal: 1.48, vertikal: 1.73

