

Ergebnis: **395.6** (378)
 Serien: 97.6 98.6 100.5 98.9
 Zähler: 21 16 3 0 0 0 0 0 0 0
 Innenzehner: 13
 Weitester: 541 (27.), 512 (11.), 503 (37.)
 beste Teiler: 37.8 (10.), 60.4 (23.), 62.0 (33.)
 Trefferlage: 0.25 mm links, 0.10 mm tief
 Streuwert: 2.16, horizontal: 2.76, vertikal: 1.30

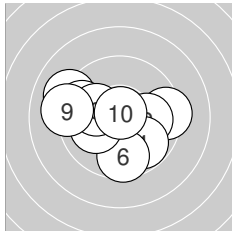
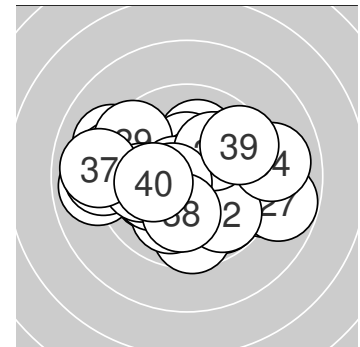

Serie 1: 97.6 (94)

9.4 → 10.0 → 9.1 ↖ 9.8 ↘ 9.6 ↖
 9.6 ↓ 10.1 ↙ 10.1 ↖ 9.1 ← 10.8* ↑

beste Teiler: 37.8 (10.), 209.0 (8.), 220.0 (7.)
 Trefferlage: 0.74 mm links, 0.18 mm tief
 Streuwert: 2.33, horizontal: 2.91, vertikal: 1.54

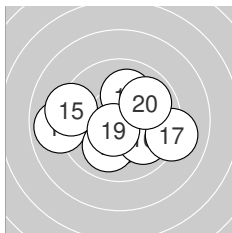

Serie 2: 98.6 (94)

8.9 ← 10.3* ↓ 10.0 ↘ 10.5* → 9.3 ↖
 9.9 ↘ 9.1 → 10.1 ↑ 10.6* ↘ 9.9 ↗

beste Teiler: 98.4 (19.), 110.0 (14.), 153.0 (12.)
 Trefferlage: 0.03 mm links, 0.33 mm tief
 Streuwert: 2.27, horizontal: 2.88, vertikal: 1.42

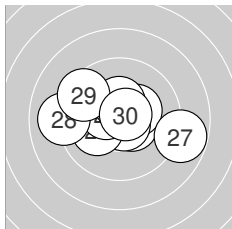

Serie 3: 100.5 (96)

10.5* ↘ 10.3* ↗ 10.7* ↘ 10.1 ← 10.5* ↖
 10.4* ↑ 8.8 → 9.0 ← 9.5 ↖ 10.7* ↗

beste Teiler: 60.4 (23.), 65.6 (30.), 116.2 (21.)
 Trefferlage: 0.24 mm links, 0.18 mm hoch
 Streuwert: 2.07, horizontal: 2.73, vertikal: 1.07

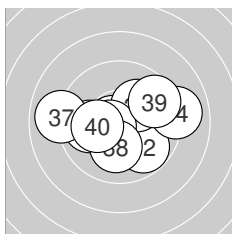

Serie 4: 98.9 (94)

9.9 ← 9.8 ↘ 10.7* ← 9.0 → 10.1 ↗
 10.6* ← 8.9 ← 10.1 ↓ 9.6 ↗ 10.2* ←

beste Teiler: 62.0 (33.), 89.5 (36.), 194.1 (40.)
 Trefferlage: 0.00 mm, 0.07 mm tief
 Streuwert: 2.24, horizontal: 2.89, vertikal: 1.29



Ergebnis: **395.7** (379)
 Serien: 96.7 98.7 101.4 98.9
 Zähler: 21 17 2 0 0 0 0 0 0 0
 Innenzehner: 16
 Weitester: 582 (38.), 509 (7.), 496 (40.)
 beste Teiler: 22.4 (16.), 48.8 (3.), 57.0 (32.)
 Trefferlage: 0.50 mm links, 0.20 mm tief
 Streuwert: 2.11, horizontal: 2.07, vertikal: 2.15

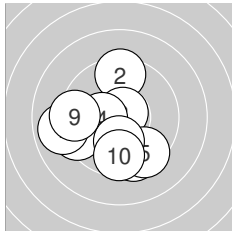
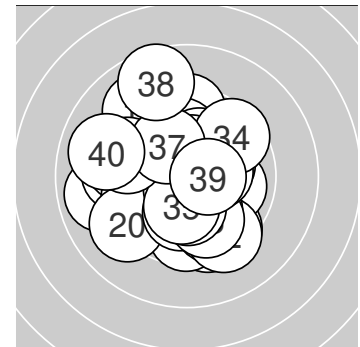

Serie 1: 96.7 (92)

9.5 ↓	9.4 ↑	10.8* ↗	10.3* ←	9.4 ↓
9.3 ←	8.9 ←	10.1 ↓	9.4 ←	9.6 ↓

beste Teiler: 48.8 (3.), 155.1 (4.), 212.0 (8.)
 Trefferlage: 1.06 mm links, 1.03 mm tief
 Streuwert: 2.32, horizontal: 2.41, vertikal: 2.22

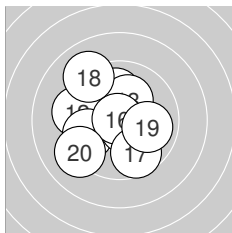

Serie 2: 98.7 (94)

10.0 ↑	9.4 ←	10.2* ↗	9.7 ←	10.6* ↓
10.9* ↖	9.7 ↓	9.1 ↘	9.9 →	9.2 ↙

beste Teiler: 22.4 (16.), 90.8 (15.), 191.0 (13.)
 Trefferlage: 0.81 mm links, 0.05 mm hoch
 Streuwert: 2.19, horizontal: 2.21, vertikal: 2.17

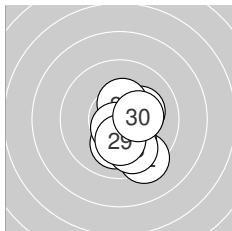

Serie 3: 101.4 (98)

10.4* ↓	9.3 ↓	10.1 ↓	10.1 ↓	9.8 ↓
10.2* →	10.4* ↑	10.6* ↓	10.2* ↓	10.3* →

beste Teiler: 82.4 (28.), 127.1 (21.), 138.2 (27.)
 Trefferlage: 0.72 mm rechts, 1.16 mm tief
 Streuwert: 1.27, horizontal: 0.94, vertikal: 1.53

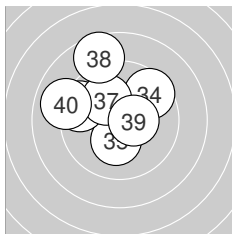

Serie 4: 98.9 (95)

10.4* ↘	10.7* →	10.3* ↘	9.6 ↗	10.2* ↓
9.5 ←	10.1 ↘	8.6 ↑	10.5* →	9.0 ←

beste Teiler: 57.0 (32.), 124.0 (39.), 143.5 (31.)
 Trefferlage: 0.86 mm links, 1.32 mm hoch
 Streuwert: 2.03, horizontal: 2.16, vertikal: 1.89



Ergebnis: 398.4 (377)
Serien: 95.4 100.8 100.6 101.6
Zähler: 20 17 3 0 0 0 0 0 0 0
Innenzehner: 16
Weiteste: 699 (30.), 556 (7.), 543 (9.)
beste Teiler: 41.6 (36.), 52.3 (25.), 54.5 (26.)
Trefferlage: 0.52 mm links, 0.73 mm tief
Streuwert: 1.96, horizontal: 2.41, vertikal: 1.37

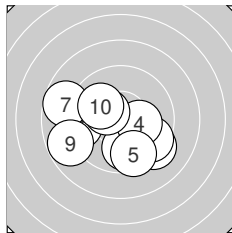
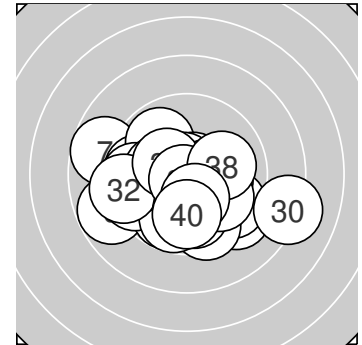

Serie 1: 95.4 (91)

9.3 ↘	9.5 ↘	9.8 ↓	10.2* →	9.5 ↓
9.3 ←	8.7 ←	10.3* ↖	8.8 ←	10.0 ↖

beste Teiler: 152.5 (8.), 186.1 (4.), 233.8 (10.)
Trefferlage: 0.79 mm links, 1.06 mm tief
Streuwert: 2.60, horizontal: 3.20, vertikal: 1.80

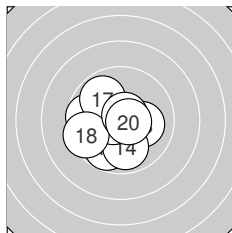

Serie 2: 100.8 (94)

9.8 ↓	9.9 ←	10.1 →	9.9 ↓	10.7* ←
9.7 ←	9.9 ↖	9.5 ←	10.7* ↗	10.6* →

beste Teiler: 62.4 (19.), 74.3 (15.), 79.4 (20.)
Trefferlage: 0.91 mm links, 0.45 mm tief
Streuwert: 1.64, horizontal: 1.82, vertikal: 1.44

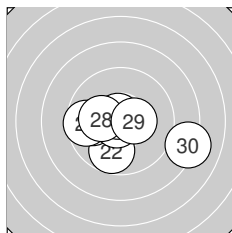

Serie 3: 100.6 (95)

10.7* ←	9.8 ↓	9.9 ←	10.4* ←	10.7* ↗
10.7* ↖	9.6 ←	10.2* ←	10.4* →	8.2 →

beste Teiler: 52.3 (25.), 54.5 (26.), 75.5 (21.)
Trefferlage: 0.37 mm links, 0.50 mm tief
Streuwert: 2.13, horizontal: 2.78, vertikal: 1.14

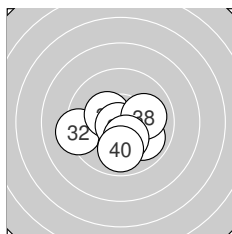

Serie 4: 101.6 (97)

10.6* ↗	9.3 ←	10.4* ↘	10.0 ↓	10.4* ↖
10.8* ↗	9.9 ↘	10.0 →	10.3* ↓	9.9 ↓

beste Teiler: 41.6 (36.), 80.7 (31.), 131.2 (33.)
Trefferlage: 0.01 mm links, 0.92 mm tief
Streuwert: 1.51, horizontal: 1.83, vertikal: 1.10



Ergebnis: **397.3** (379)
 Serien: 96.8 99.8 101.2 99.5
 Zähler: 21 17 2 0 0 0 0 0 0 0
 Innenzehner: 15
 Weitester: 568 (9.), 510 (5.), 471 (17.)
 beste Teiler: 28.8 (29.), 53.2 (33.), 53.7 (20.)
 Trefferlage: 0.04 mm rechts, 0.24 mm tief
 Streuwert: 2.08, horizontal: 2.61, vertikal: 1.36

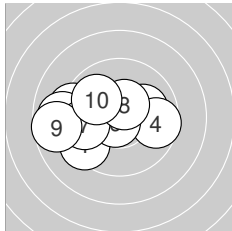
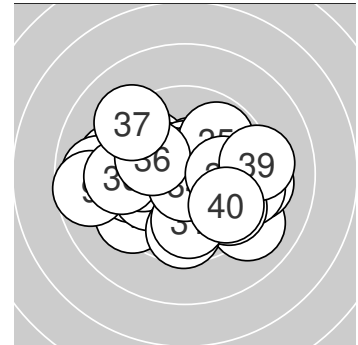

Serie 1: 96.8 (91)

9.4 ↙	9.3 ←	10.1 →	9.6 →	8.9 ←
10.7* ↙	9.7 ←	10.5* ↑	8.7 ←	9.9 ↘

beste Teiler: 57.3 (6.), 120.5 (8.), 219.4 (3.)
 Trefferlage: 1.77 mm links, 0.06 mm tief
 Streuwert: 2.29, horizontal: 3.02, vertikal: 1.18

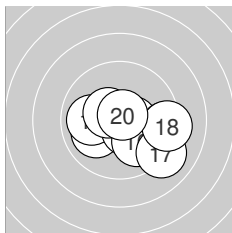

Serie 2: 99.8 (97)

10.0 ↙	10.0 ←	10.5* ↘	10.5* →	9.3 →
10.0 ↘	9.1 ↘	9.2 →	10.5* ↘	10.7* ↑

beste Teiler: 53.7 (20.), 111.5 (13.), 114.6 (14.)
 Trefferlage: 1.00 mm rechts, 0.69 mm tief
 Streuwert: 1.90, horizontal: 2.45, vertikal: 1.08

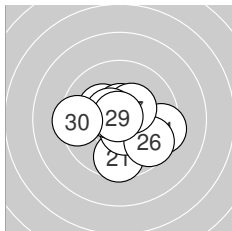

Serie 3: 101.2 (96)

9.6 ↓	10.3* ↘	10.5* ↘	9.4 →	10.6* ↑
9.6 ↘	10.4* ↗	10.6* ↘	10.8* ↘	9.4 ←

beste Teiler: 28.8 (29.), 93.0 (25.), 100.1 (28.)
 Trefferlage: 0.15 mm rechts, 0.37 mm tief
 Streuwert: 1.79, horizontal: 2.08, vertikal: 1.43

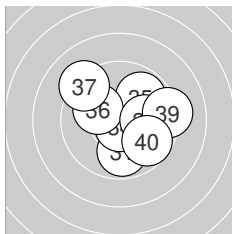

Serie 4: 99.5 (95)

9.8 ↓	10.3* →	10.7* ↘	10.7* ↓	9.8 ↗
10.1 ↖	9.2 ↘	10.0 →	9.2 →	9.7 ↘

beste Teiler: 53.2 (33.), 56.0 (34.), 157.4 (32.)
 Trefferlage: 0.78 mm rechts, 0.15 mm hoch
 Streuwert: 1.96, horizontal: 2.19, vertikal: 1.71



Ergebnis: **386.6** (368)
 Serien: 96.7 97.6 95.3 97.0
 Zähler: 14 20 6 0 0 0 0 0 0 0
 Innenzehner: 11
 Weitester: 623 (32.), 594 (22.), 544 (6.)
 beste Teiler: 122.4 (27.), 131.1 (15.), 137.2 (21.)
 Trefferlage: 0.04 mm rechts, 0.00 mm
 Streuwert: 2.51, horizontal: 2.45, vertikal: 2.58

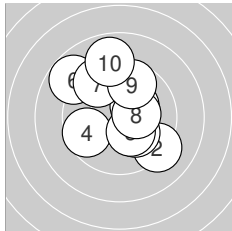
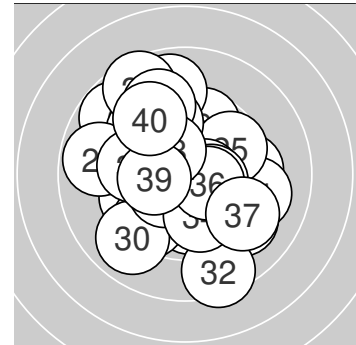

Serie 1: 96.7 (92)

10.3* ↗	9.2 ↘	10.1 ↘	9.6 ←	10.3* ↘
8.8 ↘	9.5 ↘	10.3* →	9.7 ↑	8.9 ↑

beste Teiler: 156.7 (8.), 166.8 (5.), 172.0 (1.)
 Trefferlage: 0.01 mm links, 0.91 mm hoch
 Streuwert: 2.53, horizontal: 2.41, vertikal: 2.65

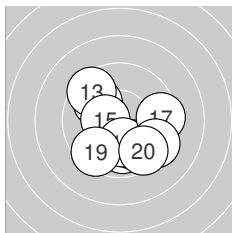

Serie 2: 97.6 (93)

9.9 ↓	9.9 ↘	9.5 ↘	10.0 ↓	10.4* ←
10.1 ↓	9.4 →	9.4 ↘	9.5 ↗	9.5 ↘

beste Teiler: 131.1 (15.), 205.0 (16.), 246.4 (14.)
 Trefferlage: 0.28 mm rechts, 1.01 mm tief
 Streuwert: 2.15, horizontal: 2.29, vertikal: 1.99

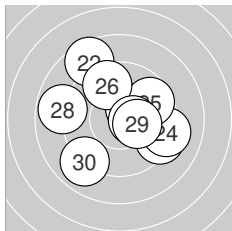

Serie 3: 95.3 (90)

10.4* ↗	8.6 ↘	9.3 ↘	9.2 →	9.7 ↗
9.6 ↘	10.5* →	8.8 ←	10.3* →	8.9 ↗

beste Teiler: 122.4 (27.), 137.2 (21.), 166.6 (29.)
 Trefferlage: 0.21 mm rechts, 0.44 mm hoch
 Streuwert: 2.89, horizontal: 3.17, vertikal: 2.58

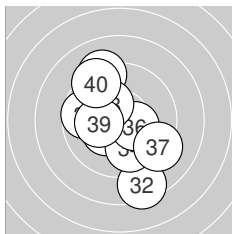

Serie 4: 97.0 (93)

9.7 ←	8.5 ↓	10.3* ↗	9.9 ↓	9.2 ↘
10.4* →	9.2 ↘	10.3* ↘	10.2* ←	9.3 ↘

beste Teiler: 149.4 (36.), 159.1 (33.), 174.7 (38.)
 Trefferlage: 0.30 mm links, 0.30 mm tief
 Streuwert: 2.58, horizontal: 2.14, vertikal: 2.96



Ergebnis: 388.1 (368)
Serien: 90.3 97.8 99.7 100.3
Zähler: 18 17 4 0 0 0 0 1 0 0 0
Innenzehner: 14
Weiteste: 1765 (1.), 652 (10.), 629 (11.)
beste Teiler: 13.1 (35.), 45.8 (4.), 78.5 (16.)
Trefferlage: 0.00 mm , 0.03 mm tief
Streuwert: 2.99, horizontal: 2.69, vertikal: 3.27

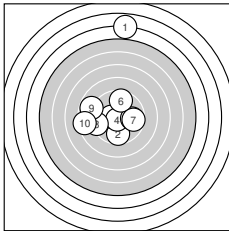
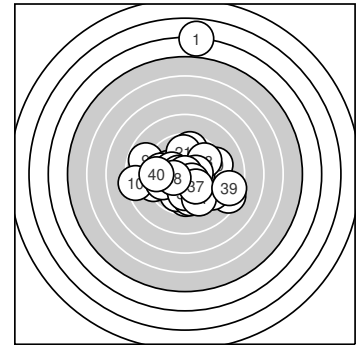

Serie 1: 90.3 (84)

3.9 ↑ 9.7 ↓ 10.5* ← 10.8* ↓ 9.8 →
 9.6 ↑ 9.7 → 9.2 ← 8.8 ← 8.3 ←

beste Teiler: 45.8 (4.), 125.3 (3.), 282.0 (5.)
Trefferlage: 0.88 mm links, 1.59 mm hoch
Streuwert: 4.77, horizontal: 3.29, vertikal: 5.89

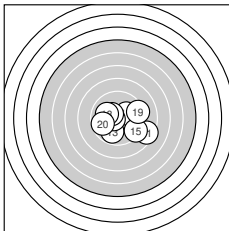

Serie 2: 97.8 (94)

8.4 ↘ 10.1 ↙ 9.8 ↓ 10.2* → 9.2 ↘
 10.6* ← 10.4* ↖ 10.1 ← 9.3 → 9.7 ←

beste Teiler: 78.5 (16.), 136.8 (17.), 192.8 (14.)
Trefferlage: 0.53 mm rechts, 0.67 mm tief
Streuwert: 2.37, horizontal: 2.95, vertikal: 1.60

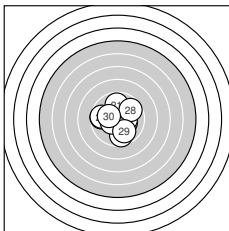

Serie 3: 99.7 (94)

9.8 ↑ 9.7 ← 9.7 ↓ 10.3* → 9.7 ←
 10.4* ← 10.3* → 9.7 ↗ 9.9 ↘ 10.2* ←

beste Teiler: 130.8 (26.), 161.0 (27.), 174.9 (24.)
Trefferlage: 0.15 mm links, 0.08 mm tief
Streuwert: 1.91, horizontal: 2.03, vertikal: 1.78

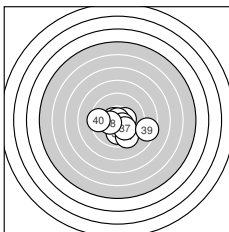

Serie 4: 100.3 (96)

10.6* ← 10.0 ↓ 10.4* → 9.5 ↓ 10.9* ↑
 10.5* ↘ 10.1 ↘ 10.3* ← 8.5 → 9.5 ←

beste Teiler: 13.1 (35.), 82.2 (31.), 121.6 (36.)
Trefferlage: 0.52 mm rechts, 0.98 mm tief
Streuwert: 1.95, horizontal: 2.47, vertikal: 1.21



Ergebnis: 385.7 (366)
Serien: 93.5 99.2 98.5 94.5
Zähler: 16 14 10 0 0 0 0 0 0 0 0
Innenzehner: 10
Weiteste: 695 (1.), 640 (2.), 589 (39.)
beste Teiler: 47.6 (32.), 55.2 (12.), 67.0 (15.)
Trefferlage: 0.03 mm links, 0.34 mm hoch
Streuwert: 2.68, horizontal: 3.42, vertikal: 1.63

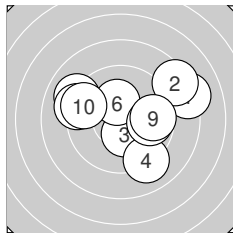
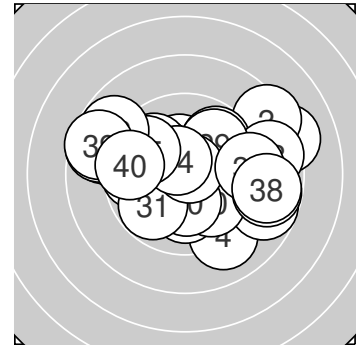

Serie 1: 93.5 (90)

8.2 →	8.4 ↗	10.4* ↓	9.1 ↓	9.0 ↖
10.3* ↑	9.8 →	9.2 ↖	9.7 →	9.4 ↖

beste Teiler: 146.4 (3.), 168.6 (6.), 285.9 (7.)
Trefferlage: 0.83 mm rechts, 0.66 mm hoch
Streuwert: 3.16, horizontal: 3.92, vertikal: 2.16

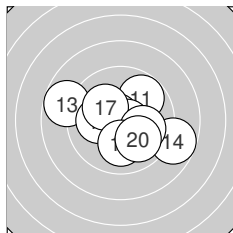

Serie 2: 99.2 (95)

9.8 ↗	10.7* ↖	8.8 ↖	8.8 →	10.7* →
10.1 ←	10.2* ↖	10.0 →	10.1 ↓	10.0 ↘

beste Teiler: 55.2 (12.), 67.0 (15.), 195.7 (17.)
Trefferlage: 0.24 mm rechts, 0.17 mm tief
Streuwert: 2.28, horizontal: 2.83, vertikal: 1.56

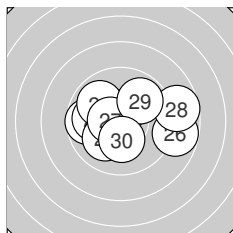

Serie 3: 98.5 (93)

9.7 ←	10.0 ←	10.6* ↑	9.9 ↖	10.1 ↗
8.8 →	10.6* ←	8.7 →	9.9 ↗	10.2* ↓

beste Teiler: 81.0 (23.), 100.4 (27.), 178.3 (30.)
Trefferlage: 0.26 mm rechts, 0.15 mm hoch
Streuwert: 2.37, horizontal: 3.07, vertikal: 1.34

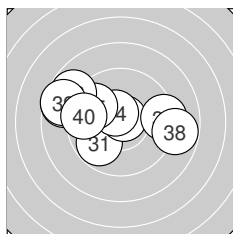

Serie 4: 94.5 (88)

9.8 ↗	10.8* ↗	9.3 →	10.5* ↖	9.8 ↖
8.8 ↖	8.6 ↖	8.8 →	8.6 ↖	9.5 ↖

beste Teiler: 47.6 (32.), 102.0 (34.), 289.2 (31.)
Trefferlage: 1.46 mm links, 0.74 mm hoch
Streuwert: 2.88, horizontal: 3.82, vertikal: 1.42



Ergebnis: **401.1** (384)
 Serien: 98.9 101.8 102.5 97.9
 Zähler: 24 16 0 0 0 0 0 0 0 0
 Innenzehner: 15
 Weitester: 438 (3.), 416 (31.), 395 (36.)
 beste Teiler: 42.0 (6.), 71.5 (24.), 78.0 (21.)
 Trefferlage: 0.28 mm rechts, 0.79 mm hoch
 Streuwert: 1.68, horizontal: 2.05, vertikal: 1.18

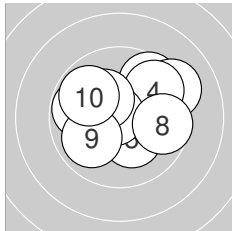
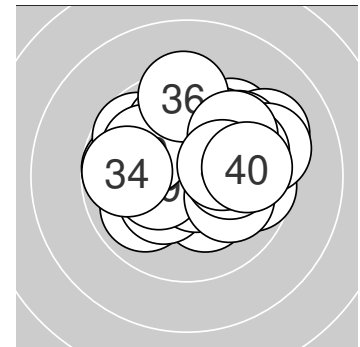

Serie 1: 98.9 (93)

9.8 ←	9.6 ↗	9.2 ↗	9.7 ↗	10.2* ↘
10.8* ←	10.2* ↘	9.7 →	9.9 ↖	9.8 ↖

beste Teiler: 42.0 (6.), 176.5 (7.), 177.1 (5.)
 Trefferlage: 0.39 mm rechts, 0.68 mm hoch
 Streuwert: 2.03, horizontal: 2.46, vertikal: 1.49

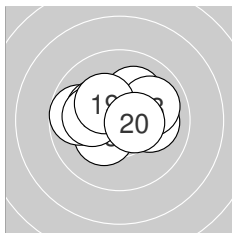

Serie 2: 101.8 (99)

10.1 →	10.5* ←	10.3* ↗	10.1 ↗	9.7 ←
10.2* ←	10.1 ←	10.0 →	10.3* ↘	10.5* →

beste Teiler: 112.4 (20.), 118.4 (12.), 161.9 (13.)
 Trefferlage: 0.35 mm links, 0.43 mm hoch
 Streuwert: 1.44, horizontal: 1.86, vertikal: 0.82

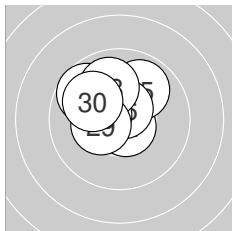

Serie 3: 102.5 (98)

10.6* ↑	9.7 ↘	10.2* ↑	10.7* ↘	9.9 ↗
10.6* ↑	10.4* ←	10.0 ↑	10.4* ←	10.0 ↖

beste Teiler: 71.5 (24.), 78.0 (21.), 81.9 (26.)
 Trefferlage: 0.59 mm links, 1.06 mm hoch
 Streuwert: 1.14, horizontal: 1.22, vertikal: 1.05

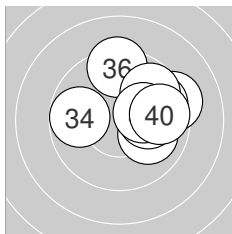

Serie 4: 97.9 (94)

9.3 ↗	10.0 ↘	9.7 ↗	9.8 ←	10.0 ↗
9.4 ↑	10.1 →	9.7 ↗	10.2* →	9.7 →

beste Teiler: 184.3 (39.), 213.2 (37.), 233.7 (35.)
 Trefferlage: 1.68 mm rechts, 1.00 mm hoch
 Streuwert: 1.67, horizontal: 1.94, vertikal: 1.33



Ergebnis: **382.3** (364)
 Serien: 89.1 100.0 96.3 96.9
 Zähler: 13 21 3 3 0 0 0 0 0 0
 Innenzehner: 11
 Weitester: 956 (36.), 813 (6.), 776 (5.)
 beste Teiler: 2.8 (11.), 26.9 (16.), 97.2 (39.)
 Trefferlage: 1.04 mm rechts, 1.62 mm hoch
 Streuwert: 2.55, horizontal: 2.85, vertikal: 2.19

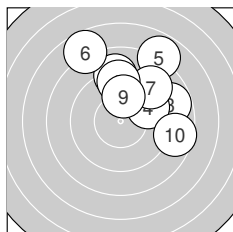
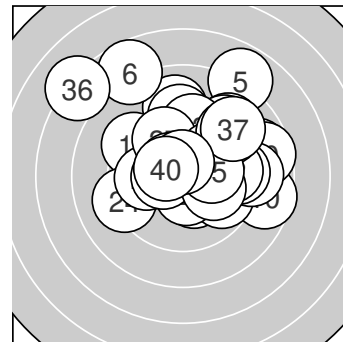

Serie 1: 89.1 (84)

9.2 ↗	9.0 ↑	8.8 →	9.7 ↗	7.8 ↗
7.7 ↘	9.1 ↗	9.3 ↑	9.9 ↑	8.6 →

beste Teiler: 260.7 (9.), 321.1 (4.), 414.5 (8.)
 Trefferlage: 2.04 mm rechts, 3.29 mm hoch
 Streuwert: 2.78, horizontal: 2.97, vertikal: 2.57

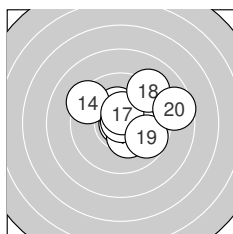

Serie 2: 100.0 (95)

10.9* ↘	10.3* ↑	10.4* →	9.3 ↘	10.3* ↘
10.8* ↗	10.5* ↑	9.2 ↗	9.7 →	8.6 →

beste Teiler: 2.8 (11.), 26.9 (16.), 105.5 (17.)
 Trefferlage: 0.99 mm rechts, 0.71 mm hoch
 Streuwert: 2.01, horizontal: 2.40, vertikal: 1.52

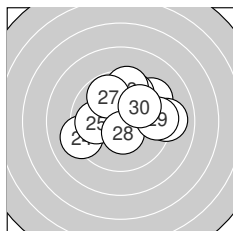

Serie 3: 96.3 (91)

9.4 ↗	9.7 ↑	9.5 ↑	9.2 ←	9.9 ←
9.0 →	9.8 ↘	10.5* ↓	9.4 →	9.9 ↗

beste Teiler: 121.5 (28.), 252.8 (30.), 253.2 (25.)
 Trefferlage: 0.80 mm rechts, 1.01 mm hoch
 Streuwert: 2.36, horizontal: 2.82, vertikal: 1.77

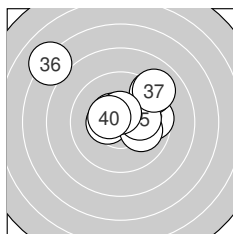

Serie 4: 96.9 (94)

10.4* ←	9.6 →	9.2 ↗	10.0 →	10.1 →
7.1 ↘	9.0 ↗	10.5* ↘	10.6* ↑	10.4* ↘

beste Teiler: 97.2 (39.), 118.3 (38.), 128.9 (40.)
 Trefferlage: 0.32 mm rechts, 1.45 mm hoch
 Streuwert: 2.77, horizontal: 3.31, vertikal: 2.08



Ergebnis: **386.0** (369)
 Serien: 93.3 98.1 95.7 98.9
 Zähler: 18 13 9 0 0 0 0 0 0 0
 Innenzehner: 12
 Weitester: 719 (7.), 708 (16.), 707 (4.)
 beste Teiler: 38.9 (31.), 61.2 (11.), 89.1 (13.)
 Trefferlage: 0.44 mm links, 0.19 mm tief
 Streuwert: 2.64, horizontal: 2.99, vertikal: 2.24

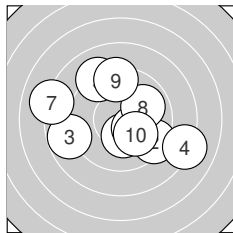
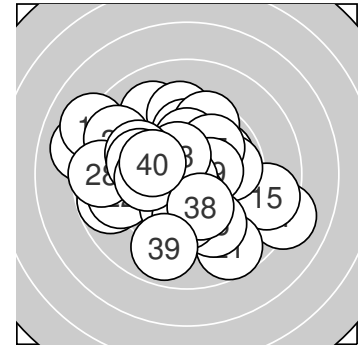

Serie 1: 93.3 (90)

10.3* ↓	9.3 ↘	8.8 ←	8.1 →	9.1 ↖
10.3* ↘	8.1 ←	9.9 ↗	9.3 ↑	10.1 ↘

beste Teiler: 158.3 (6.), 168.3 (1.), 212.1 (10.)
 Trefferlage: 0.03 mm rechts, 0.01 mm hoch
 Streuwert: 3.35, horizontal: 4.00, vertikal: 2.55

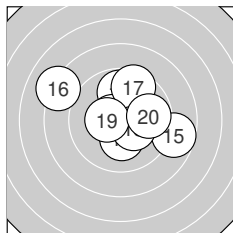

Serie 2: 98.1 (93)

10.7* ↗	9.8 ↑	10.6* ↖	10.2* ↓	8.7 →
8.1 ↖	9.5 ↑	10.3* ↘	10.4* ←	9.8 →

beste Teiler: 61.2 (11.), 89.1 (13.), 138.0 (19.)
 Trefferlage: 0.26 mm rechts, 0.65 mm hoch
 Streuwert: 2.52, horizontal: 3.03, vertikal: 1.89

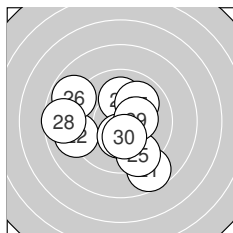

Serie 3: 95.7 (92)

8.7 ↘	9.1 ←	10.1 ↑	10.4* ↓	9.4 ↘
8.8 ↖	10.0 ↗	8.6 ←	10.3* →	10.3* ↓

beste Teiler: 150.5 (24.), 157.4 (29.), 161.5 (30.)
 Trefferlage: 0.68 mm links, 0.60 mm tief
 Streuwert: 2.78, horizontal: 3.12, vertikal: 2.40

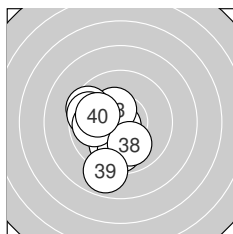

Serie 4: 98.9 (94)

10.8* ↘	10.0 ↓	10.4* ↖	9.8 ↓	9.5 ↖
9.6 ←	9.9 ←	10.0 ↓	8.9 ↓	10.0 ↖

beste Teiler: 38.9 (31.), 142.6 (33.), 237.1 (38.)
 Trefferlage: 1.39 mm links, 0.85 mm tief
 Streuwert: 1.80, horizontal: 1.44, vertikal: 2.10



Ergebnis: **407.3** (390)
 Serien: 102.1 102.9 100.7 101.6
 Zähler: 30 10 0 0 0 0 0 0 0 0
 Innenzehner: 22
 Weitestе: 368 (39.), 351 (30.), 347 (13.)
 beste Teiler: 23.7 (27.), 35.3 (18.), 37.0 (19.)
 Trefferlage: 0.25 mm rechts, 0.40 mm tief
 Streuwert: 1.49, horizontal: 1.44, vertikal: 1.53

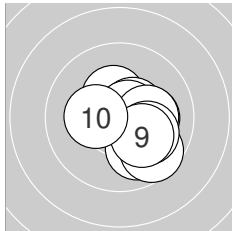
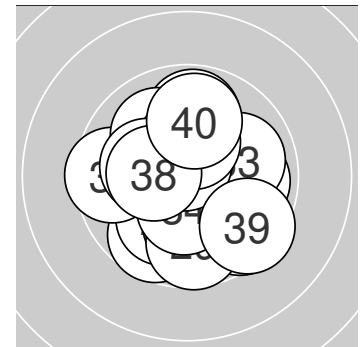

Serie 1: 102.1 (99)

10.4* ↗	10.5* ↘	10.0 ↘	10.2* →	10.7* ↘
9.6 ↘	10.2* →	10.1 ↘	10.1 ↘	10.3* ←

beste Teiler: 68.7 (5.), 108.2 (2.), 147.7 (1.)
 Trefferlage: 1.03 mm rechts, 0.45 mm tief
 Streuwert: 1.24, horizontal: 1.25, vertikal: 1.23

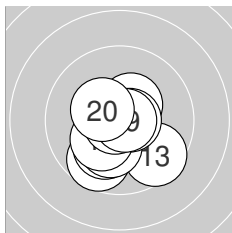

Serie 2: 102.9 (98)

9.7 ↙	10.4* ↗	9.6 ↘	10.1 ↙	10.2* ↙
10.7* →	10.2* ↙	10.8* ←	10.8* →	10.4* ↘

beste Teiler: 35.3 (18.), 37.0 (19.), 70.0 (16.)
 Trefferlage: 0.16 mm links, 0.85 mm tief
 Streuwert: 1.31, horizontal: 1.25, vertikal: 1.36

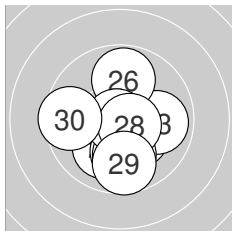

Serie 3: 100.7 (95)

10.1 ↙	10.3* ↘	9.9 →	10.0 ↓	9.9 ↓
9.8 ↑	10.9* ↙	10.6* ↘	9.7 ↓	9.5 ←

beste Teiler: 23.7 (27.), 82.1 (28.), 170.4 (22.)
 Trefferlage: 0.08 mm rechts, 0.89 mm tief
 Streuwert: 1.65, horizontal: 1.59, vertikal: 1.71

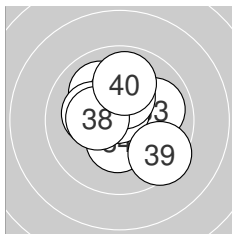

Serie 4: 101.6 (98)

10.0 ↘	10.3* ↑	10.0 →	10.4* ↓	10.7* ↑
10.3* ↑	10.2* ←	10.3* ←	9.5 ↘	9.9 ↑

beste Teiler: 62.3 (35.), 146.6 (34.), 152.2 (32.)
 Trefferlage: 0.07 mm rechts, 0.58 mm hoch
 Streuwert: 1.54, horizontal: 1.55, vertikal: 1.52



Ergebnis: **375.2** (356)
 Serien: 93.3 94.6 93.4 93.9
 Zähler: 11 18 9 1 0 1 0 0 0 0 0
 Innenzehner: 7
 Weitestе: 1344 (15.), 824 (7.), 694 (26.)
 beste Teiler: 50.6 (19.), 56.0 (29.), 105.9 (14.)
 Trefferlage: 0.26 mm links, 0.55 mm hoch
 Streuwert: 3.26, horizontal: 3.93, vertikal: 2.43

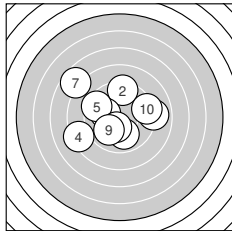
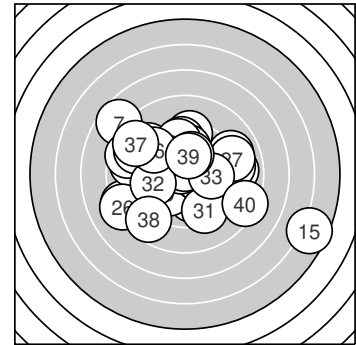

Serie 1: 93.3 (89)

8.9 →	9.3 ↑	10.1 ←	8.3 ←	9.5 ↖
9.9 ↓	7.7 ↘	10.3* ↓	10.0 ↗	9.3 →

beste Teiler: 153.3 (8.), 217.5 (3.), 244.1 (9.)
 Trefferlage: 0.99 mm links, 0.42 mm hoch
 Streuwert: 3.28, horizontal: 3.79, vertikal: 2.68

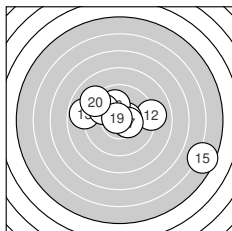

Serie 2: 94.6 (90)

10.5* →	9.1 →	8.8 ←	10.5* →	5.6 ↘
10.0 ↑	10.4* →	9.8 ↘	10.8* ↖	9.1 ↖

beste Teiler: 50.6 (19.), 105.9 (14.), 114.2 (11.)
 Trefferlage: 0.80 mm rechts, 0.28 mm hoch
 Streuwert: 3.82, horizontal: 4.88, vertikal: 2.30

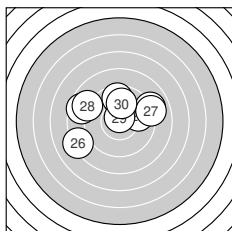

Serie 3: 93.4 (88)

9.8 →	8.6 ↖	9.8 ↑	9.0 →	9.6 ↑
8.2 ←	9.0 →	8.8 ↖	10.7* ↑	9.9 ↑

beste Teiler: 56.0 (29.), 264.4 (30.), 287.7 (21.)
 Trefferlage: 0.47 mm links, 1.47 mm hoch
 Streuwert: 3.08, horizontal: 3.94, vertikal: 1.88

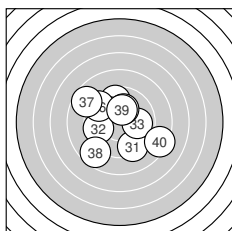

Serie 4: 93.9 (89)

9.3 ↓	9.7 ←	9.9 →	9.6 ↑	10.1 ↑
9.4 ↖	8.7 ↖	8.7 ↗	10.2* ↑	8.3 ↘

beste Teiler: 183.3 (39.), 201.8 (35.), 260.6 (33.)
 Trefferlage: 0.38 mm links, 0.03 mm hoch
 Streuwert: 3.11, horizontal: 3.34, vertikal: 2.86



Ergebnis: 399.2 (379)
Serien: 99.0 99.0 100.6 100.6
Zähler: 22 15 3 0 0 0 0 0 0 0 0
Innenzehner: 17
Weiteste: 677 (16.), 652 (7.), 525 (12.)
beste Teiler: 73.5 (5.), 73.5 (19.), 78.4 (1.)
Trefferlage: 0.60 mm links, 0.31 mm hoch
Streuwert: 1.98, horizontal: 2.41, vertikal: 1.41

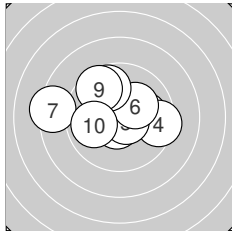
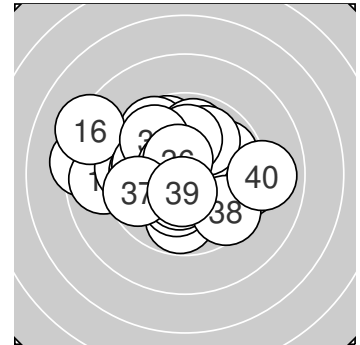

Serie 1: 99.0 (94)

10.6* ←	10.6* ↓	10.0 →	9.4 →	10.7* ↘
10.2* ↗	8.3 ←	9.7 ↘	9.6 ↘	9.9 ←

beste Teiler: 73.5 (5.), 78.4 (1.), 87.2 (2.)
Trefferlage: 0.48 mm links, 0.50 mm hoch
Streuwert: 2.25, horizontal: 2.87, vertikal: 1.36

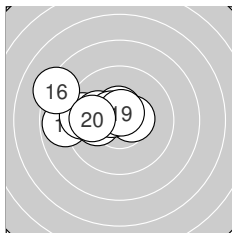

Serie 2: 99.0 (94)

10.5* →	8.9 ←	10.5* ↑	9.5 ←	10.1 ←
8.2 ↖	10.1 ←	10.6* ↖	10.7* ↑	9.9 ←

beste Teiler: 73.5 (19.), 100.4 (18.), 105.6 (13.)
Trefferlage: 2.14 mm links, 0.60 mm hoch
Streuwert: 1.78, horizontal: 2.36, vertikal: 0.90

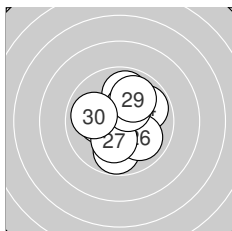

Serie 3: 100.6 (95)

9.8 ↓	9.9 ↑	10.5* ↓	9.8 ↗	10.2* ←
10.0 ↘	10.2* ↓	10.4* ↗	9.9 ↗	9.9 ←

beste Teiler: 105.2 (23.), 149.4 (28.), 179.0 (25.)
Trefferlage: 0.22 mm rechts, 0.06 mm hoch
Streuwert: 1.69, horizontal: 1.55, vertikal: 1.82

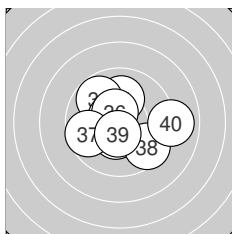

Serie 4: 100.6 (96)

10.1 ↑	10.4* ↓	10.5* ↖	9.8 ↖	10.6* ↖
10.5* ↖	9.7 ←	9.5 ↘	10.5* ↓	9.0 →

beste Teiler: 94.4 (35.), 106.0 (36.), 114.4 (39.)
Trefferlage: 0.01 mm rechts, 0.06 mm hoch
Streuwert: 1.95, horizontal: 2.28, vertikal: 1.55



Ergebnis: 392.0 (374)
Serien: 96.5 98.3 97.3 99.9
Zähler: 19 16 5 0 0 0 0 0 0 0 0
Innenzehner: 13
Weiteste: 664 (40.), 657 (30.), 604 (8.)
beste Teiler: 75.6 (25.), 83.4 (7.), 96.5 (38.)
Trefferlage: 0.24 mm rechts, 0.47 mm hoch
Streuwert: 2.33, horizontal: 2.75, vertikal: 1.83

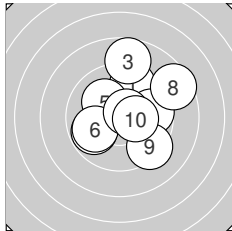
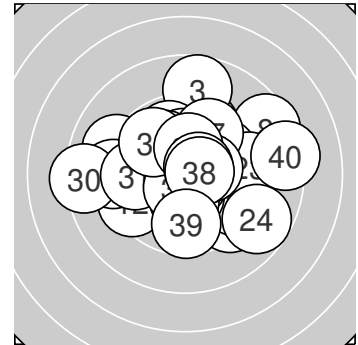

Serie 1: 96.5 (91)

9.6 ↗ 9.7 → 8.7 ↑ 9.8 ↖ 10.1 ↘
 9.9 ↖ 10.6* ↗ 8.5 ↗ 9.3 ↘ 10.3* →

beste Teiler: 83.4 (7.), 155.7 (10.), 209.3 (5.)
Trefferlage: 0.92 mm rechts, 0.86 mm hoch
Streuwert: 2.50, horizontal: 2.50, vertikal: 2.49

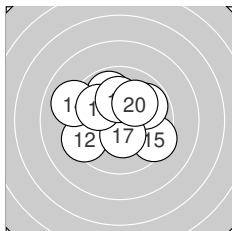

Serie 2: 98.3 (95)

9.9 ↘ 9.4 ↖ 10.1 → 9.1 ↖ 9.4 ↘
 9.8 ↗ 10.4* ↓ 10.0 ↖ 10.1 ↑ 10.1 ↗

beste Teiler: 145.3 (17.), 202.4 (19.), 204.7 (13.)
Trefferlage: 0.14 mm links, 0.56 mm hoch
Streuwert: 2.17, horizontal: 2.59, vertikal: 1.66

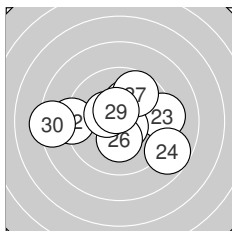

Serie 3: 97.3 (93)

10.2* ↗ 9.1 ← 9.3 → 8.8 ↘ 10.7* ↘
 10.3* ↓ 9.7 ↗ 10.4* ↖ 10.5* ↖ 8.3 ←

beste Teiler: 75.6 (25.), 109.7 (29.), 140.9 (28.)
Trefferlage: 0.12 mm links, 0.12 mm hoch
Streuwert: 2.71, horizontal: 3.48, vertikal: 1.63

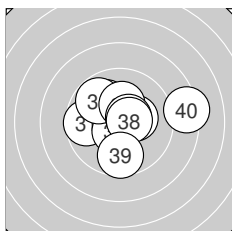

Serie 4: 99.9 (95)

9.7 ← 10.0 ↘ 10.6* ↘ 10.3* → 9.8 ↘
 10.3* ↑ 10.6* ↗ 10.6* → 9.7 ↓ 8.3 →

beste Teiler: 96.5 (38.), 98.8 (37.), 99.7 (33.)
Trefferlage: 0.31 mm rechts, 0.37 mm hoch
Streuwert: 2.17, horizontal: 2.63, vertikal: 1.58



Ergebnis: 402.4 (386)
Serien: 98.8 102.1 101.0 100.5
Zähler: 29 8 3 0 0 0 0 0 0 0 0
Innenzehner: 25
Weiteste: 585 (3.), 542 (9.), 535 (36.)
beste Teiler: 11.1 (12.), 77.6 (35.), 83.9 (40.)
Trefferlage: 0.04 mm links, 0.38 mm tief
Streuwert: 1.84, horizontal: 2.33, vertikal: 1.15

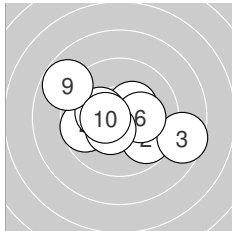
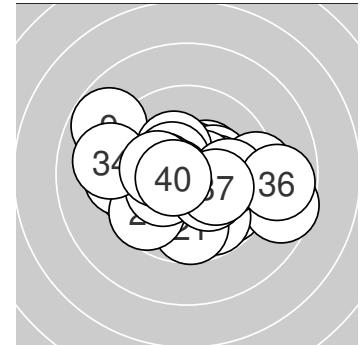

Serie 1: 98.8 (94)

10.3* ← 9.8 ↘ 8.6 → 9.7 ← 10.4* ↗
 10.2* → 10.4* ↙ 10.2* ← 8.8 ↘ 10.4* ←

beste Teiler: 127.0 (10.), 132.8 (7.), 146.2 (5.)
Trefferlage: 0.21 mm links, 0.20 mm tief
Streuwert: 2.32, horizontal: 2.96, vertikal: 1.41

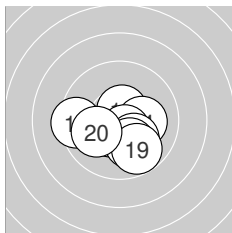

Serie 2: 102.1 (98)

10.4* ↙ 10.9* ↘ 10.6* ↑ 10.2* → 10.6* ↘
 10.1 ↘ 9.4 ← 10.1 ↘ 9.8 ↘ 10.0 ↙

beste Teiler: 11.1 (12.), 90.4 (13.), 99.2 (15.)
Trefferlage: 0.03 mm links, 0.86 mm tief
Streuwert: 1.45, horizontal: 1.78, vertikal: 1.02

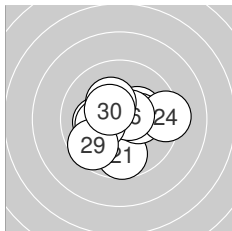

Serie 3: 101.0 (97)

9.7 ↓ 10.3* ↗ 10.3* → 9.3 → 10.2* ←
 10.6* ↗ 10.3* ↘ 10.2* ← 9.6 ↙ 10.5* ↘

beste Teiler: 92.3 (26.), 121.6 (30.), 166.1 (23.)
Trefferlage: 0.07 mm rechts, 0.23 mm tief
Streuwert: 1.73, horizontal: 2.01, vertikal: 1.41

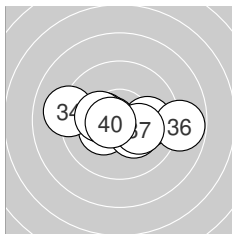

Serie 4: 100.5 (97)

10.3* ← 10.0 → 10.3* ↘ 9.1 ← 10.6* ←
 8.8 → 10.2* ↘ 10.4* ← 10.2* ← 10.6* ←

beste Teiler: 77.6 (35.), 83.9 (40.), 146.5 (38.)
Trefferlage: 0.00 mm , 0.24 mm tief
Streuwert: 1.98, horizontal: 2.75, vertikal: 0.58



Ergebnis: **368.5** (352)
 Serien: 92.1 93.0 90.7 92.7
 Zähler: 11 16 8 4 1 0 0 0 0 0 0
 Innenzehner: 9
 Weitester: 1102 (6.), 886 (39.), 881 (20.)
 beste Teiler: 53.7 (3.), 78.1 (19.), 81.3 (30.)
 Trefferlage: 0.40 mm links, 0.43 mm hoch
 Streuwert: 3.51, horizontal: 4.09, vertikal: 2.81

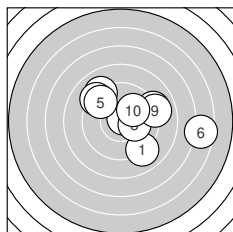
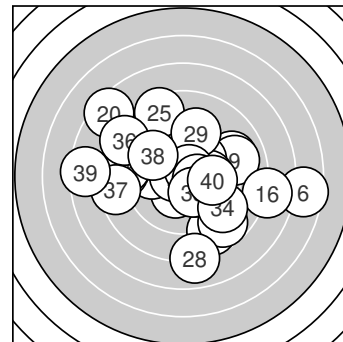

Serie 1: 92.1 (90)

9.0 ↘	9.1 ↖	10.7* ↗	9.2 ↖	9.4 ↖
6.5 →	9.0 ↗	10.2* →	9.0 →	10.0 ↗

beste Teiler: 53.7 (3.), 195.2 (8.), 228.7 (10.)
 Trefferlage: 1.82 mm rechts, 0.89 mm hoch
 Streuwert: 3.47, horizontal: 4.33, vertikal: 2.31

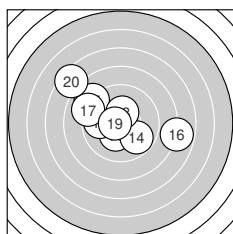

Serie 2: 93.0 (88)

10.3* ↙	8.9 ↖	9.8 ←	9.8 ↘	9.0 ↖
7.8 →	9.0 ↖	10.4* ↑	10.6* ←	7.4 ↖

beste Teiler: 78.1 (19.), 147.8 (18.), 168.8 (11.)
 Trefferlage: 1.32 mm links, 1.03 mm hoch
 Streuwert: 3.38, horizontal: 4.09, vertikal: 2.48

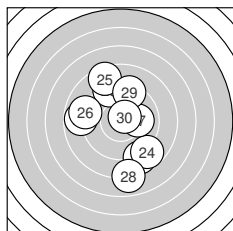

Serie 3: 90.7 (86)

8.7 ↘	8.8 ←	9.2 ↑	8.7 ↘	8.5 ↑
9.0 ←	10.0 →	7.9 ↓	9.3 ↑	10.6* ↗

beste Teiler: 81.3 (30.), 232.2 (27.), 410.3 (29.)
 Trefferlage: 0.25 mm links, 0.04 mm tief
 Streuwert: 3.74, horizontal: 3.10, vertikal: 4.29

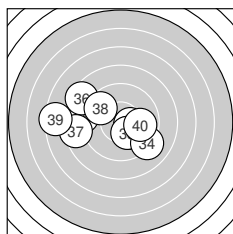

Serie 4: 92.7 (88)

10.4* →	10.2* ↘	10.3* ↘	9.1 ↘	8.8 ←
8.5 ↖	8.5 ←	9.6 ↖	7.4 ←	9.9 →

beste Teiler: 132.7 (31.), 172.0 (33.), 180.2 (32.)
 Trefferlage: 1.86 mm links, 0.13 mm tief
 Streuwert: 3.30, horizontal: 4.31, vertikal: 1.79



Ergebnis: 378.3 (359)
Serien: 90.2 95.8 94.7 97.6
Zähler: 11 20 6 3 0 0 0 0 0 0 0
Innenzehner: 9
Weiteste: 981 (8.), 893 (7.), 845 (24.)
beste Teiler: 39.5 (25.), 99.1 (23.), 109.6 (18.)
Trefferlage: 0.68 mm rechts, 0.26 mm tief
Streuwert: 3.05, horizontal: 3.78, vertikal: 2.07

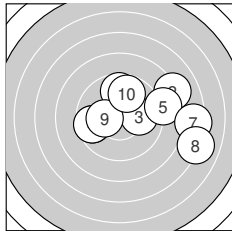
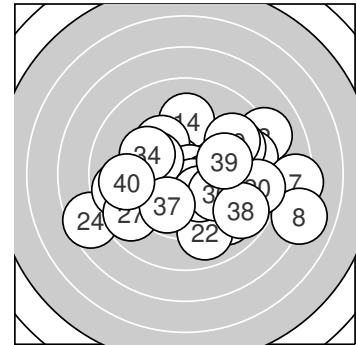

Serie 1: 90.2 (86)

9.6 ← 8.1 → 10.0 → 9.6 ← 8.8 →
 9.7 ↑ 7.4 → 7.0 → 10.2* ← 9.8 ↑
beste Teiler: 181.5 (9.), 236.1 (3.), 296.7 (10.)
Trefferlage: 2.45 mm rechts, 0.46 mm hoch
Streuwert: 3.69, horizontal: 4.76, vertikal: 2.13

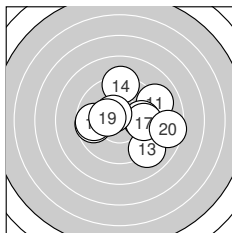

Serie 2: 95.8 (91)

9.1 → 9.7 ← 9.0 ↘ 9.2 ↑ 9.7 ←
 9.9 → 9.8 → 10.5* ↘ 10.3* ← 8.6 →
beste Teiler: 109.6 (18.), 151.4 (19.), 265.2 (16.)
Trefferlage: 1.06 mm rechts, 0.21 mm hoch
Streuwert: 2.65, horizontal: 3.16, vertikal: 2.01

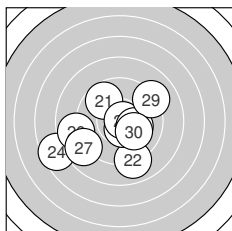

Serie 3: 94.7 (90)

9.7 ↘ 9.0 ↓ 10.6* ↓ 7.6 ← 10.8* →
 8.8 ← 8.8 ↗ 10.2* → 9.1 → 10.1 ↘
beste Teiler: 39.5 (25.), 99.1 (23.), 191.3 (28.)
Trefferlage: 0.93 mm links, 1.02 mm tief
Streuwert: 3.12, horizontal: 3.69, vertikal: 2.41

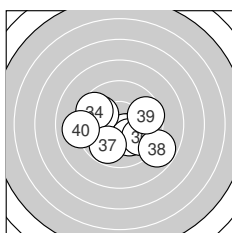

Serie 4: 97.6 (92)

10.3* ↘ 10.5* ↘ 9.9 ↘ 9.6 ↘ 10.2* ↘
 9.8 ↘ 9.8 ↗ 8.8 ↘ 9.6 → 9.1 ←
beste Teiler: 120.9 (32.), 155.4 (31.), 198.0 (35.)
Trefferlage: 0.17 mm rechts, 0.72 mm tief
Streuwert: 2.36, horizontal: 2.96, vertikal: 1.55



Ergebnis: **404.7** (390)
 Serien: 99.6 101.0 103.0 101.1
 Zähler: 31 8 1 0 0 0 0 0 0 0
 Innenzehner: 24
 Weitester: 645 (2.), 473 (16.), 447 (4.)
 beste Teiler: 58.0 (26.), 59.2 (7.), 69.7 (14.)
 Trefferlage: 0.10 mm links, 0.30 mm hoch
 Streuwert: 1.73, horizontal: 1.97, vertikal: 1.45

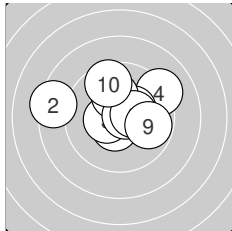
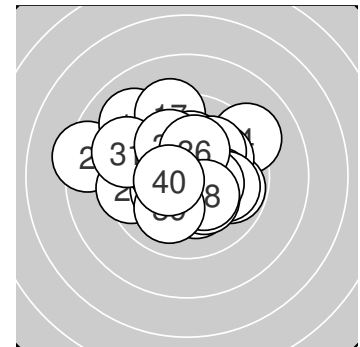

Serie 1: 99.6 (95)

10.5* ↙	8.4 ←	10.5* ←	9.2 ↗	10.4* ↗
10.1 ↑	10.7* →	10.4* →	9.8 →	9.6 ↑

beste Teiler: 59.2 (7.), 107.4 (1.), 124.1 (3.)
 Trefferlage: 0.01 mm rechts, 0.81 mm hoch
 Streuwert: 2.19, horizontal: 2.76, vertikal: 1.40

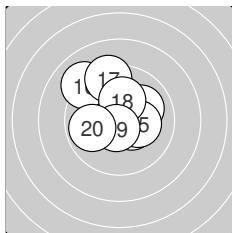

Serie 2: 101.0 (97)

10.6* ↗	10.4* ↘	10.0 ↗	10.7* ↑	10.2* →
9.1 ↘	9.3 ↑	10.2* ↑	10.6* ↙	9.9 ←

beste Teiler: 69.7 (14.), 76.6 (11.), 81.1 (19.)
 Trefferlage: 0.12 mm links, 0.89 mm hoch
 Streuwert: 1.73, horizontal: 1.77, vertikal: 1.69

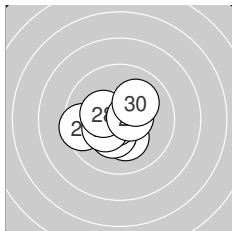

Serie 3: 103.0 (99)

10.5* ↙	10.6* →	10.2* ↓	10.3* ↙	9.5 ←
10.7* ↙	10.3* ↙	10.3* ←	10.5* →	10.1 ↗

beste Teiler: 58.0 (26.), 83.6 (22.), 101.2 (29.)
 Trefferlage: 0.45 mm links, 0.35 mm tief
 Streuwert: 1.27, horizontal: 1.51, vertikal: 0.99

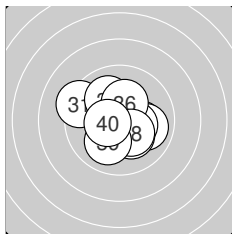

Serie 4: 101.1 (99)

9.3 ↘	10.1 →	10.0 →	10.0 ↘	10.4* →
10.3* ↑	10.2* ↘	10.3* ↘	10.0 ↙	10.5* ←

beste Teiler: 118.1 (40.), 146.4 (35.), 162.1 (38.)
 Trefferlage: 0.12 mm rechts, 0.13 mm tief
 Streuwert: 1.66, horizontal: 1.90, vertikal: 1.39



Ergebnis: 408.5 (391)
Serien: 101.2 102.6 103.6 101.1
Zähler: 31 9 0 0 0 0 0 0 0 0
Innenzehner: 25
Weiteste: 362 (6.), 349 (16.), 336 (33.)
beste Teiler: 28.8 (21.), 71.0 (15.), 71.8 (35.)
Trefferlage: 0.41 mm links, 0.52 mm tief
Streuwert: 1.39, horizontal: 1.57, vertikal: 1.18

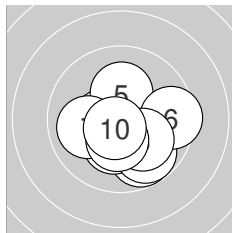
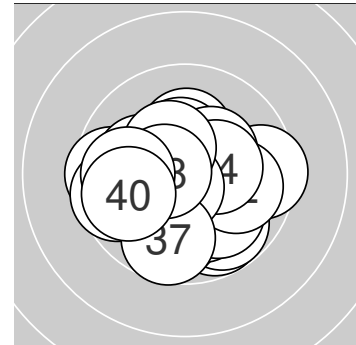

Serie 1: 101.2 (97)

10.5* ←	9.8 ↘	10.3* ↓	9.8 ↘	10.2* ↑
9.5 →	10.0 ←	10.1 ↘	10.4* ↓	10.6* ↘

beste Teiler: 76.5 (10.), 117.1 (1.), 150.9 (9.)
Trefferlage: 0.38 mm rechts, 0.88 mm tief
Streuwert: 1.53, horizontal: 1.72, vertikal: 1.32

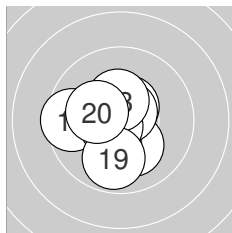

Serie 2: 102.6 (98)

10.2* ↘	10.3* ←	10.5* ↗	10.2* ←	10.7* ↗
9.6 ←	10.6* ↗	10.4* ↑	9.9 ↓	10.2* ←

beste Teiler: 71.0 (15.), 77.9 (17.), 107.8 (13.)
Trefferlage: 0.81 mm links, 0.10 mm tief
Streuwert: 1.30, horizontal: 1.33, vertikal: 1.26

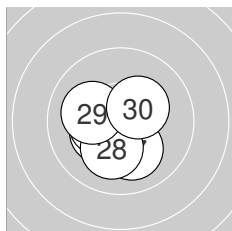

Serie 3: 103.6 (100)

10.8* ↓	10.4* ←	10.4* ←	10.3* ←	10.4* ←
10.6* ↓	10.1 ↓	10.2* ↓	10.1 ←	10.3* ↗

beste Teiler: 28.8 (21.), 81.3 (26.), 135.3 (22.)
Trefferlage: 0.61 mm links, 0.47 mm tief
Streuwert: 1.03, horizontal: 1.09, vertikal: 0.96

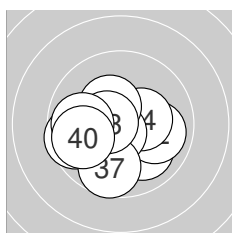

Serie 4: 101.1 (96)

10.0 ↘	10.0 →	9.6 ←	10.4* →	10.7* ↘
10.4* ↘	9.7 ↓	10.6* ←	9.9 ←	9.8 ←

beste Teiler: 71.8 (35.), 98.8 (38.), 147.1 (36.)
Trefferlage: 0.60 mm links, 0.61 mm tief
Streuwert: 1.62, horizontal: 1.95, vertikal: 1.19



Ergebnis: **397.7** (383)
 Serien: 96.7 102.6 97.9 100.5
 Zähler: 25 13 2 0 0 0 0 0 0 0
 Innenzehner: 15
 Weitester: 641 (4.), 558 (2.), 494 (6.)
 beste Teiler: 50.0 (19.), 62.6 (20.), 83.0 (11.)
 Trefferlage: 0.39 mm rechts, 0.24 mm hoch
 Streuwert: 2.03, horizontal: 2.24, vertikal: 1.80

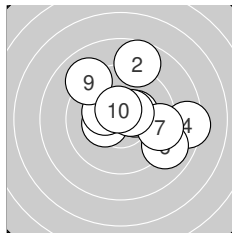
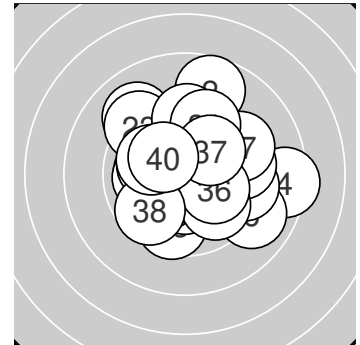

Serie 1: 96.7 (93)

10.3* ←	8.7 ↑	10.3* ↖	8.4 →	10.4* →
9.0 ↘	9.4 →	10.5* ↗	9.1 ↘	10.6* ↑

beste Teiler: 95.5 (10.), 114.5 (8.), 149.1 (5.)
 Trefferlage: 1.21 mm rechts, 0.75 mm hoch
 Streuwert: 2.62, horizontal: 2.94, vertikal: 2.25

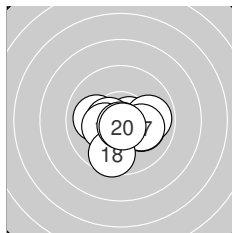

Serie 2: 102.6 (98)

10.6* →	10.0 ←	10.5* ←	10.1 →	10.3* ←
9.9 →	10.1 →	9.6 ↓	10.8* ↓	10.7* ↓

beste Teiler: 50.0 (19.), 62.6 (20.), 83.0 (11.)
 Trefferlage: 0.18 mm rechts, 0.60 mm tief
 Streuwert: 1.37, horizontal: 1.66, vertikal: 0.98

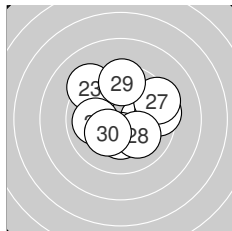

Serie 3: 97.9 (95)

9.5 ↘	10.1 →	9.3 ↘	9.5 →	10.3* ↓
10.0 ←	9.4 ↗	10.1 ↘	9.5 ↑	10.2* ↗

beste Teiler: 160.0 (25.), 177.5 (30.), 220.0 (22.)
 Trefferlage: 0.20 mm rechts, 0.71 mm hoch
 Streuwert: 2.22, horizontal: 2.45, vertikal: 1.96

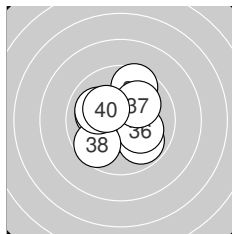

Serie 4: 100.5 (97)

9.6 ↑	10.1 ↖	10.5* ↗	10.4* →	9.8 ↘
10.1 ↘	10.1 ↗	9.7 ↗	10.0 ↖	10.2* ↖

beste Teiler: 106.3 (33.), 140.0 (34.), 176.0 (40.)
 Trefferlage: 0.02 mm links, 0.11 mm hoch
 Streuwert: 1.75, horizontal: 1.83, vertikal: 1.68



Ergebnis: **401.7** (388)
 Serien: 100.1 99.5 102.2 99.9
 Zähler: 28 12 0 0 0 0 0 0 0 0
 Innenzehner: 18
 Weitester: 500 (8.), 465 (17.), 457 (15.)
 beste Teiler: 54.5 (25.), 65.8 (38.), 68.0 (16.)
 Trefferlage: 0.11 mm rechts, 0.21 mm hoch
 Streuwert: 1.85, horizontal: 1.73, vertikal: 1.96

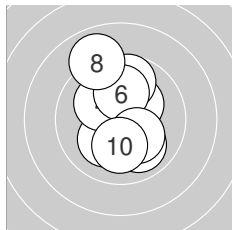
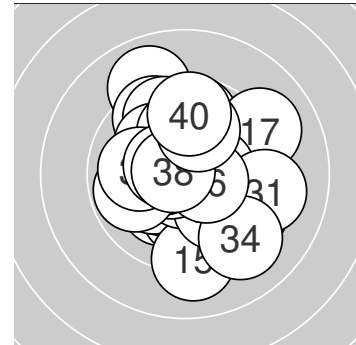

Serie 1: 100.1 (98)

10.5* ↗	10.1 ↙	10.3* ↗	10.1 ↖	9.7 ↑
10.1 ↑	10.0 ↘	9.0 ↘	10.2* ↘	10.1 ↓

beste Teiler: 112.0 (1.), 173.2 (3.), 185.9 (9.)
 Trefferlage: 0.08 mm rechts, 0.57 mm hoch
 Streuwert: 1.86, horizontal: 1.25, vertikal: 2.31

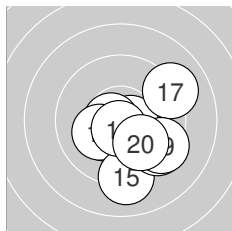

Serie 2: 99.5 (96)

10.6* →	10.6* ←	10.3* ↗	10.2* ↗	9.1 ↓
10.7* ↓	9.1 ↗	9.5 ↘	9.4 ↘	10.0 ↘

beste Teiler: 68.0 (16.), 77.1 (12.), 84.7 (11.)
 Trefferlage: 0.93 mm rechts, 1.12 mm tief
 Streuwert: 1.88, horizontal: 1.98, vertikal: 1.78

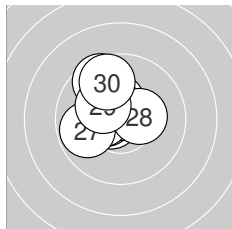

Serie 3: 102.2 (97)

10.6* ←	10.4* ↑	9.6 ↘	10.5* ←	10.7* ↑
10.4* ←	9.8 ←	10.3* →	10.2* ↖	9.7 ↖

beste Teiler: 54.5 (25.), 76.4 (21.), 119.1 (24.)
 Trefferlage: 0.89 mm links, 0.83 mm hoch
 Streuwert: 1.22, horizontal: 1.13, vertikal: 1.31

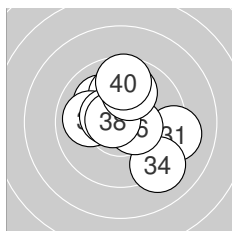

Serie 4: 99.9 (97)

9.2 →	10.1 ↖	10.1 ↑	9.1 ↘	10.0 ←
10.5* →	10.5* ↖	10.7* ←	10.0 ↑	9.7 ↑

beste Teiler: 65.8 (38.), 115.9 (37.), 121.7 (36.)
 Trefferlage: 0.33 mm rechts, 0.56 mm hoch
 Streuwert: 1.99, horizontal: 2.06, vertikal: 1.92



Ergebnis: 378.5 (363)
Serien: 92.5 97.8 95.2 93.0
Zähler: 17 13 6 4 0 0 0 0 0 0
Innenzehner: 12
Weiteste: 928 (27.), 878 (35.), 816 (6.)
beste Teiler: 84.0 (12.), 106.5 (13.), 135.5 (20.)
Trefferlage: 0.13 mm rechts, 1.14 mm hoch
Streuwert: 3.01, horizontal: 3.85, vertikal: 1.81

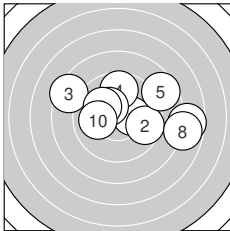
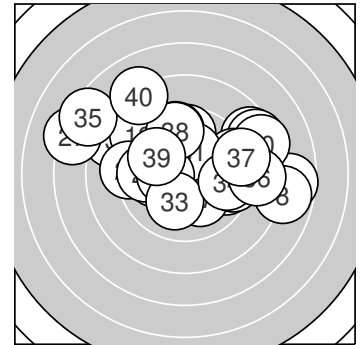

Serie 1: 92.5 (88)

10.3* → 9.6 → 8.4 ↖ 9.7 ↑ 8.6 ↗
 7.7 → 10.3* ↖ 7.8 → 10.1 ↖ 10.0 ←
beste Teiler: 160.2 (7.), 164.5 (1.), 217.5 (9.)
Trefferlage: 1.50 mm rechts, 0.81 mm hoch
Streuwert: 3.42, horizontal: 4.51, vertikal: 1.75

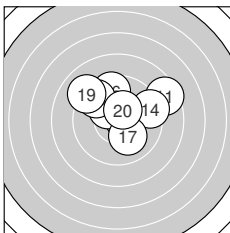

Serie 2: 97.8 (94)

8.5 ↗ 10.6* → 10.5* ↗ 9.3 → 10.3* ↖
 9.6 ↑ 10.1 ↘ 9.5 ↖ 9.0 ↖ 10.4* ↗
beste Teiler: 84.0 (12.), 106.5 (13.), 135.5 (20.)
Trefferlage: 0.44 mm rechts, 1.46 mm hoch
Streuwert: 2.24, horizontal: 2.73, vertikal: 1.59

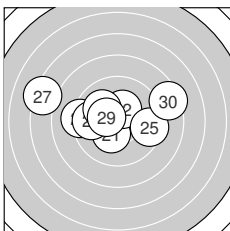

Serie 3: 95.2 (92)

10.3* ↙ 10.4* ↗ 9.2 ← 10.2* ↖ 9.4 →
 9.7 ← 7.2 ↖ 10.0 ↖ 10.4* ↖ 8.4 →
beste Teiler: 137.8 (29.), 150.2 (22.), 164.5 (21.)
Trefferlage: 1.15 mm links, 0.77 mm hoch
Streuwert: 3.05, horizontal: 4.09, vertikal: 1.35

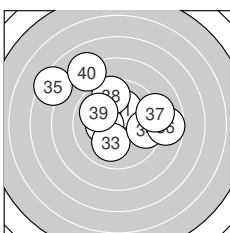

Serie 4: 93.0 (89)

10.2* ↗ 10.3* ← 10.1 ↙ 9.6 → 7.4 ↖
 8.7 → 9.1 → 9.6 ↑ 9.9 ↖ 8.1 ↖
beste Teiler: 152.3 (32.), 187.5 (31.), 224.3 (33.)
Trefferlage: 0.25 mm links, 1.54 mm hoch
Streuwert: 3.31, horizontal: 3.95, vertikal: 2.51

