

Ergebnis: **184** (193.4)
 Serien: 45 47 45 47
 Zähler: 7 10 3 0 0 0 0 0 0 0
 Innenzehner: 2
 weiteste: 664 (3), 571 (20), 549 (2)
 beste Teiler 139.1 (4.) 180.3 (8.) 212.5 (16.)
 Trefferlage 0.43 mm links, 0.16 mm tief
 Streuwert 2.51, horizontal: 3.12, vertikal: 1.71

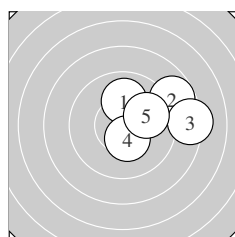

Serie 1:
 10.0 ↑ 8.8 ↗ 8.3 → 10.4 * 9.9 →
 beste Teiler 139.1 (4.) 236.4 (1.) 252.0 (5.)
 Trefferlage 2.88 mm rechts, 0.98 mm hoch
 Streuwert 2.28, horizontal: 2.81, vertikal: 1.59

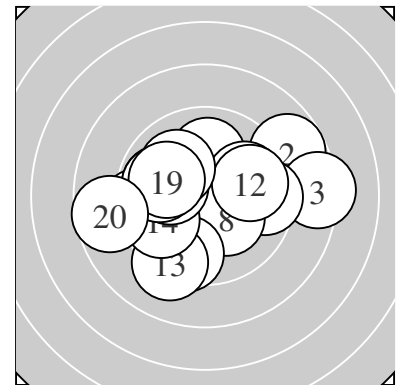
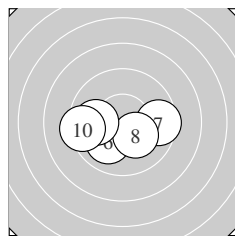

Serie 2:
 10.0 ↘ 9.5 → 10.2 * 9.9 ← 9.4 ←
 beste Teiler 180.3 (8.) 232.6 (6.) 263.0 (9.)
 Trefferlage 0.63 mm links, 0.77 mm tief
 Streuwert 2.20, horizontal: 3.02, vertikal: 0.79

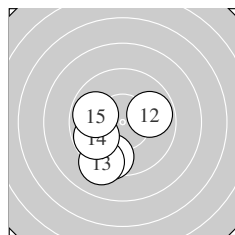

Serie 3:
 9.5 ↓ 9.9 → 9.2 ↓ 9.8 ← 9.9 ←
 beste Teiler 274.8 (15.) 275.6 (12.) 293.1 (14.)
 Trefferlage 1.15 mm links, 1.44 mm tief
 Streuwert 2.21, horizontal: 2.21, vertikal: 2.21

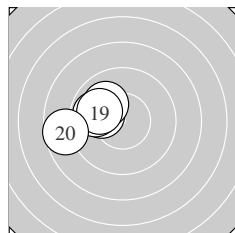

Serie 4:
 10.1 ↖ 9.9 ← 10.0 ↖ 10.0 ↖ 8.7 ←
 beste Teiler 212.5 (16.) 234.0 (18.) 245.1 (19.)
 Trefferlage 2.84 mm links, 0.55 mm hoch
 Streuwert 1.33, horizontal: 1.59, vertikal: 1.00

Unterschrift des Schützen

Meyton Elektronik

Ergebnis: **193** (201.7)
 Serien: 47 49 48 49
 Zähler: 13 7 0 0 0 0 0 0 0 0
 Innenzehner: 10
 weiteste: 453 (16), 395 (8), 316 (13)
 beste Teiler 54.4 (14.) 56.6 (9.) 90.2 (10.)
 Trefferlage 0.18 mm rechts, 0.13 mm hoch
 Streuwert 1.72, horizontal: 1.97, vertikal: 1.44

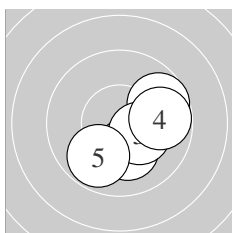
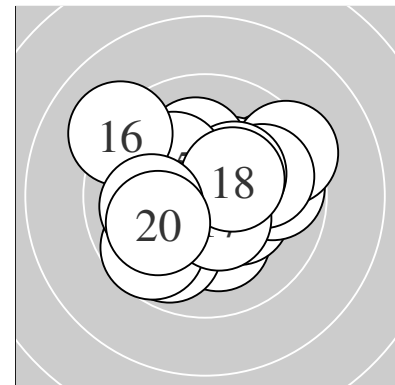

Serie 1:
 10.2 * 9.7 ↗ 10.3 * 9.8 → 9.8 ↙
 beste Teiler 160.5 (3.) 194.8 (1.) 280.4 (5.)
 Trefferlage 1.23 mm rechts, 0.64 mm tief
 Streuwert 1.69, horizontal: 1.82, vertikal: 1.53

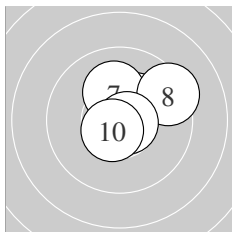

Serie 2:
 10.3 * 10.1 ↑ 9.4 ↗ 10.7 * 10.6 *
 beste Teiler 56.6 (9.) 90.2 (10.) 159.9 (6.)
 Trefferlage 0.83 mm rechts, 0.81 mm hoch
 Streuwert 1.44, horizontal: 1.63, vertikal: 1.23

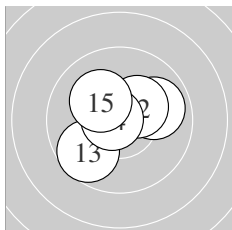

Serie 3:
 9.9 → 10.3 * 9.7 ↙ 10.7 * 10.2 *
 beste Teiler 54.4 (14.) 158.4 (12.) 193.7 (15.)
 Trefferlage 0.08 mm links, 0.20 mm hoch
 Streuwert 1.70, horizontal: 1.93, vertikal: 1.44

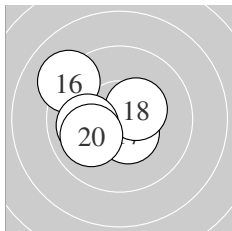

Serie 4:
 9.1 ↘ 10.5 * 10.4 * 10.0 ← 10.0 ↙
 beste Teiler 114.5 (17.) 137.7 (18.) 234.3 (20.)
 Trefferlage 1.24 mm links, 0.16 mm hoch
 Streuwert 1.84, horizontal: 2.05, vertikal: 1.59

Unterschrift des Schützen

Meyton Elektronik

Ergebnis: **187** (197.3)
 Serien: 49 44 46 48
 Zähler: 9 9 2 0 0 0 0 0 0 0
 Innenzehner: 9
 weiteste: 732 (8), 588 (7), 469 (6)
 beste Teiler 99.0 (5.) 123.9 (3.) 138.1 (14.)
 Trefferlage 0.03 mm links, 0.55 mm tief
 Streuwert 2.24, horizontal: 2.06, vertikal: 2.41

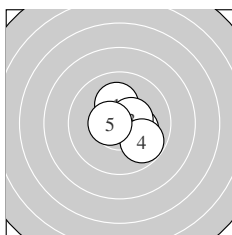
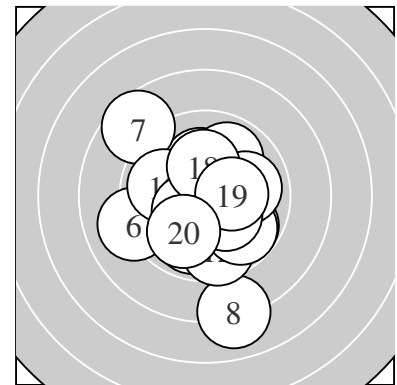

Serie 1:
 10.2 * 10.2 * 10.5 * 9.8 ↘ 10.6 *
 beste Teiler 99.0 (5.) 123.9 (3.) 185.6 (2.)
 Trefferlage 0.78 mm rechts, 0.02 mm tief
 Streuwert 1.38, horizontal: 1.38, vertikal: 1.37

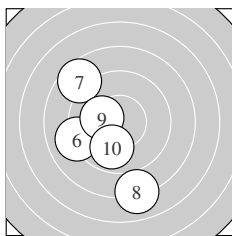

Serie 2:
 9.1 ← 8.6 ↖ 8.0 ↓ 10.2 * 9.9 ↙
 beste Teiler 186.2 (9.) 266.0 (10.) 469.0 (6.)
 Trefferlage 1.85 mm links, 1.34 mm tief
 Streuwert 3.44, horizontal: 2.53, vertikal: 4.15

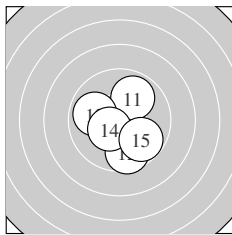

Serie 3:
 9.9 ↗ 9.6 ↓ 9.9 ← 10.4 * 9.8 ↘
 beste Teiler 138.1 (14.) 260.4 (13.) 263.6 (11.)
 Trefferlage 0.14 mm rechts, 0.65 mm tief
 Streuwert 2.04, horizontal: 1.91, vertikal: 2.17

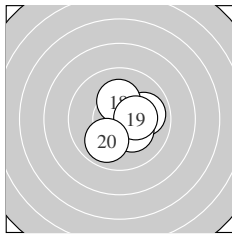

Serie 4:
 9.9 → 10.3 * 10.2 * 10.3 * 9.9 ↙
 beste Teiler 164.4 (19.) 169.9 (17.) 182.2 (18.)
 Trefferlage 0.79 mm rechts, 0.17 mm tief
 Streuwert 1.52, horizontal: 1.50, vertikal: 1.54

Unterschrift des Schützen

Meyton Elektronik

Ergebnis: **196** (205.2)
 Serien: 47 49 50 50
 Zähler: 17 2 1 0 0 0 0 0 0 0
 Innenzehner: 14
 weiteste: 609 (1), 328 (5), 319 (7)
 beste Teiler 29.0 (3.) 32.1 (20.) 44.2 (8.)
 Trefferlage 0.22 mm links, 0.44 mm hoch
 Streuwert 1.55, horizontal: 1.76, vertikal: 1.30

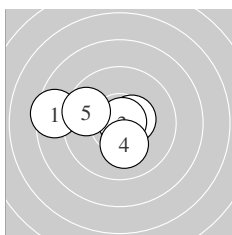
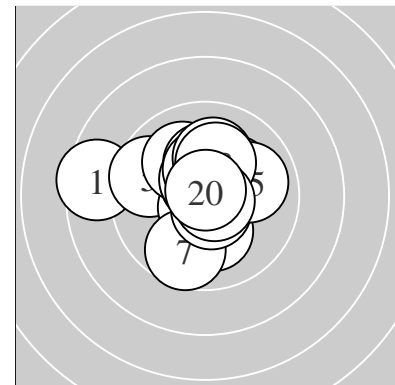

Serie 1:
 8.5 ← 10.5 * 10.8 * 10.2 * 9.6 ↖
 beste Teiler 29.0 (3.) 118.5 (2.) 198.7 (4.)
 Trefferlage 1.46 mm links, 0.10 mm hoch
 Streuwert 2.31, horizontal: 3.03, vertikal: 1.21

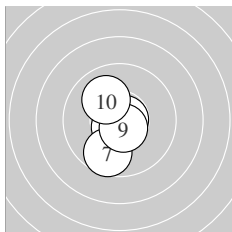

Serie 2:
 10.7 * 9.7 ↓ 10.8 * 10.6 * 10.0 ↗
 beste Teiler 44.2 (8.) 74.4 (6.) 80.9 (9.)
 Trefferlage 0.39 mm links, 0.48 mm tief
 Streuwert 1.36, horizontal: 0.79, vertikal: 1.76

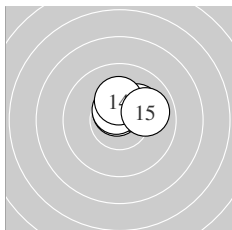

Serie 3:
 10.6 * 10.2 * 10.6 * 10.2 * 10.0 →
 beste Teiler 80.0 (11.) 98.0 (13.) 180.2 (14.)
 Trefferlage 0.66 mm rechts, 1.07 mm hoch
 Streuwert 0.93, horizontal: 1.24, vertikal: 0.43

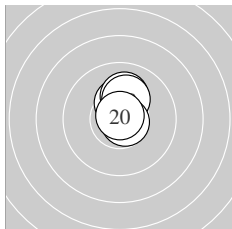

Serie 4:
 10.4 * 10.1 ↑ 10.2 * 10.7 * 10.8 *
 beste Teiler 32.1 (20.) 58.5 (19.) 149.4 (16.)
 Trefferlage 0.29 mm rechts, 1.10 mm hoch
 Streuwert 0.76, horizontal: 0.31, vertikal: 1.03

Unterschrift des Schützen

Meyton Elektronik

Ergebnis: **189** (197.2)
 Serien: 46 47 49 47
 Zähler: 10 9 1 0 0 0 0 0 0 0
 Innenzehner: 8
 weiteste: 507 (2), 484 (19), 466 (20)
 beste Teiler 26.3 (7.) 80.0 (11.) 126.2 (16.)
 Trefferlage 1.12 mm rechts, 0.13 mm hoch
 Streuwert 2.03, horizontal: 2.01, vertikal: 2.05

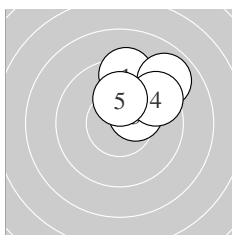
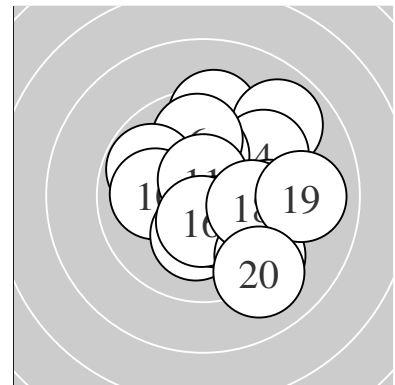

Serie 1:
 9.3 ↑ 8.9 ↗ 10.3 * 9.5 ↘ 10.2 *
 beste Teiler 152.8 (3.) 200.0 (5.) 359.4 (4.)
 Trefferlage 1.70 mm rechts, 2.45 mm hoch
 Streuwert 1.43, horizontal: 1.56, vertikal: 1.29

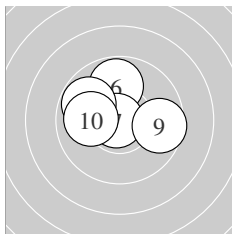

Serie 2:
 9.8 ↑ 10.8 * 9.8 ↖ 9.6 → 10.0 ←
 beste Teiler 26.3 (7.) 236.2 (10.) 281.4 (6.)
 Trefferlage 0.43 mm links, 0.74 mm hoch
 Streuwert 1.90, horizontal: 2.34, vertikal: 1.33

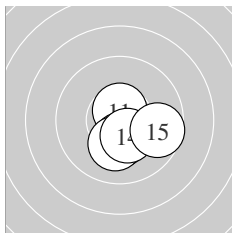

Serie 3:
 10.6 * 10.3 * 10.2 * 10.4 * 9.7 →
 beste Teiler 80.0 (11.) 143.1 (14.) 161.1 (12.)
 Trefferlage 0.69 mm rechts, 0.97 mm tief
 Streuwert 1.24, horizontal: 1.40, vertikal: 1.07

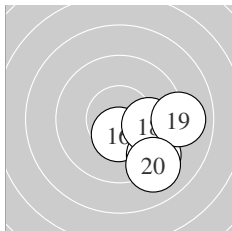

Serie 4:
 10.4 * 9.3 ↘ 10.0 → 9.0 → 9.1 ↘
 beste Teiler 126.2 (16.) 245.7 (18.) 407.4 (17.)
 Trefferlage 2.54 mm rechts, 1.69 mm tief
 Streuwert 1.68, horizontal: 1.75, vertikal: 1.60

Unterschrift des Schützen

Ergebnis: **168** (177.0)
 Serien: 41 41 43 43
 Zähler: 2 8 8 1 0 1 0 0 0 0
 Innenzehner: 2
 weiteste: 1333 (1), 834 (9), 734 (7)
 beste Teiler 106.9 (4.) 147.4 (19.) 336.1 (12.)
 Trefferlage 1.04 mm links, 1.78 mm hoch
 Streuwert 3.97, horizontal: 4.57, vertikal: 3.27

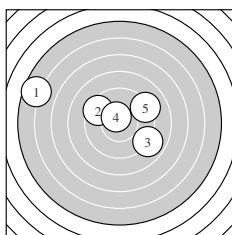
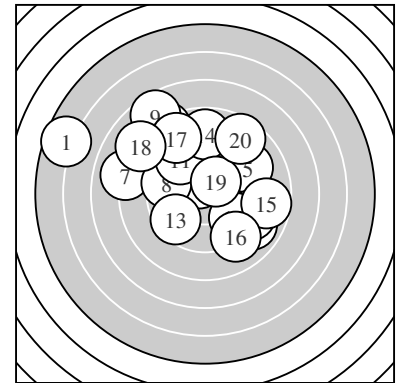

Serie 1:
 5.6 ↖ 9.5 ↖ 8.9 ↘ 10.5 * 9.1 ↗
 beste Teiler 106.9 (4.) 374.3 (2.) 452.0 (5.)
 Trefferlage 1.62 mm links, 1.43 mm hoch
 Streuwert 5.19, horizontal: 6.81, vertikal: 2.72

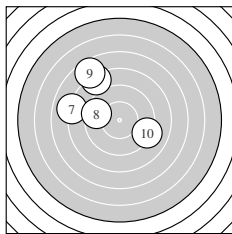

Serie 2:
 8.2 ↖ 8.0 ← 9.5 ← 7.6 ↖ 9.1 →
 beste Teiler 360.8 (8.) 453.6 (10.) 698.2 (6.)
 Trefferlage 2.89 mm links, 2.77 mm hoch
 Streuwert 3.96, horizontal: 4.19, vertikal: 3.72

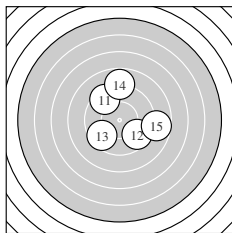

Serie 3:
 9.4 ↖ 9.6 ↘ 9.6 ↙ 8.8 ↑ 8.7 →
 beste Teiler 336.1 (12.) 350.2 (13.) 381.2 (11.)
 Trefferlage 0.64 mm rechts, 0.63 mm hoch
 Streuwert 3.42, horizontal: 3.42, vertikal: 3.42

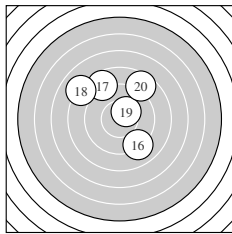

Serie 4:
 9.1 ↘ 8.7 ↖ 8.1 ↖ 10.4 * 8.6 ↗
 beste Teiler 147.4 (19.) 472.3 (16.) 565.7 (17.)
 Trefferlage 0.30 mm links, 2.30 mm hoch
 Streuwert 3.81, horizontal: 3.82, vertikal: 3.79

Unterschrift des Schützen

Ergebnis: **179** (189.5)
 Serien: 44 44 47 44
 Zähler: 4 12 3 1 0 0 0 0 0 0
 Innenzehner: 2
 weiteste: 946 (6), 622 (2), 606 (19)
 beste Teiler 10.0 (7.) 113.8 (14.) 217.6 (15.)
 Trefferlage 0.97 mm links, 0.65 mm hoch
 Streuwert 2.93, horizontal: 3.17, vertikal: 2.66

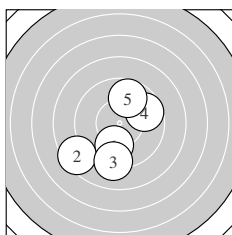
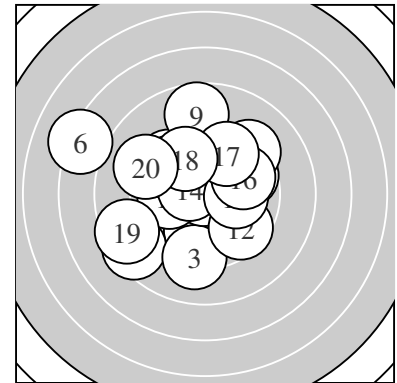

Serie 1:
 9.9 ↘ 8.5 ↙ 9.2 ↓ 9.7 → 9.7 ↑
 beste Teiler 262.6 (1.) 305.8 (5.) 317.3 (4.)
 Trefferlage 0.50 mm links, 1.30 mm tief
 Streuwert 3.07, horizontal: 2.90, vertikal: 3.23

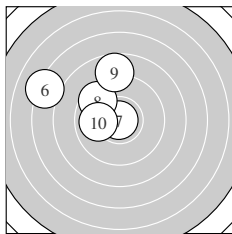

Serie 2:
 7.2 ↖ 10.9 * 9.6 ↖ 8.7 ↑ 10.0 ←
 beste Teiler 10.0 (7.) 249.8 (10.) 340.7 (8.)
 Trefferlage 2.89 mm links, 2.25 mm hoch
 Streuwert 2.99, horizontal: 3.44, vertikal: 2.45

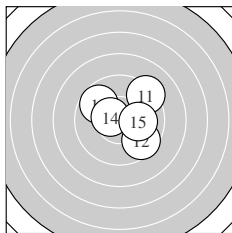

Serie 3:
 9.3 ↗ 9.6 ↘ 9.7 ↖ 10.5 * 10.1 →
 beste Teiler 113.8 (14.) 217.6 (15.) 303.2 (13.)
 Trefferlage 0.84 mm rechts, 0.52 mm hoch
 Streuwert 2.24, horizontal: 2.43, vertikal: 2.02

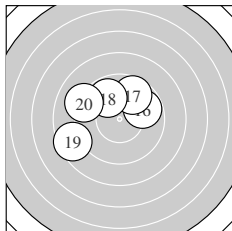

Serie 4:
 9.8 → 9.7 ↗ 9.8 ↖ 8.5 ↙ 9.1 ↖
 beste Teiler 281.1 (18.) 291.5 (16.) 318.1 (17.)
 Trefferlage 1.36 mm links, 1.13 mm hoch
 Streuwert 2.93, horizontal: 3.51, vertikal: 2.19

Unterschrift des Schützen

Ergebnis:	183	(191.3)
Serien:	49 44 45 45	
Zähler:	8 8 3 1 0 0 0 0 0 0	
Innenzehner:	6	
weiteste:	855 (6), 615 (17), 592 (11)	
beste Teiler	24.0 (16.) 110.3 (3.) 114.8 (12.)	
Trefferlage	0.51 mm rechts, 0.35 mm hoch	
Streuwert	2.90, horizontal: 2.70, vertikal: 3.08	

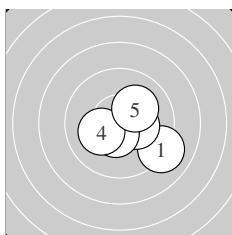
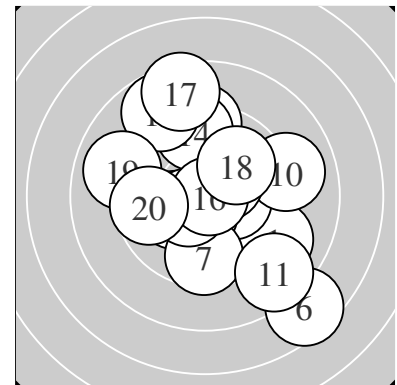

Serie 1:	9.1 ↘	10.3 *	10.5 *	10.2 *	10.1 ↗
beste Teiler	110.3 (3.)	161.1 (2.)	191.9 (4.)		
Trefferlage	0.98 mm rechts, 0.64 mm tief				
Streuwert	1.83, horizontal: 2.17, vertikal: 1.41				

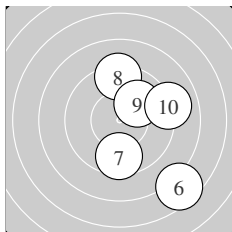

Serie 2:	7.5 ↘	9.6 ↓	9.3 ↑	10.0 ↗	9.0 →
beste Teiler	232.0 (9.)	345.0 (7.)	417.2 (8.)		
Trefferlage	2.37 mm rechts, 0.53 mm tief				
Streuwert	3.57, horizontal: 2.70, vertikal: 4.27				

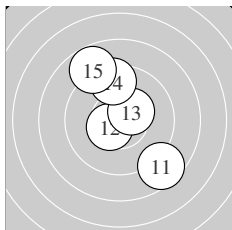

Serie 3:	8.6 ↘	10.5 *	10.4 *	9.5 ↑	8.8 ↖
beste Teiler	114.8 (12.)	137.2 (13.)	375.4 (14.)		
Trefferlage	0.18 mm rechts, 0.85 mm hoch				
Streuwert	3.13, horizontal: 2.48, vertikal: 3.66				

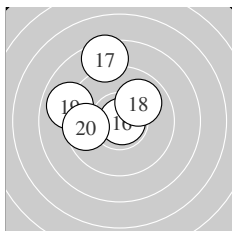

Serie 4:	10.9 *	8.5 ↑	9.9 ↗	9.0 ↖	9.6 ←
beste Teiler	24.0 (16.)	251.0 (18.)	327.8 (20.)		
Trefferlage	1.47 mm links, 1.72 mm hoch				
Streuwert	2.60, horizontal: 2.62, vertikal: 2.58				

Unterschrift des Schützen

Ergebnis: **189** (197.0)
 Serien: 48 46 48 47
 Zähler: 9 11 0 0 0 0 0 0 0 0
 Innenzehner: 8
 weiteste: 498 (18), 483 (3), 464 (7)
 beste Teiler 79.0 (20.) 80.0 (2.) 122.1 (1.)
 Trefferlage 0.28 mm rechts, 0.58 mm tief
 Streuwert 2.19, horizontal: 2.19, vertikal: 2.18

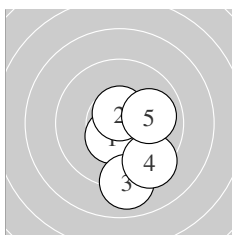
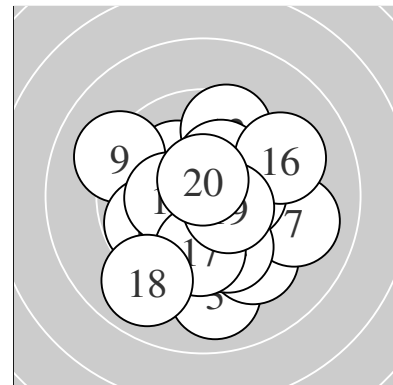

Serie 1:
 10.5 * 10.6 * 9.0 ↓ 9.4 ↘ 10.0 →
 beste Teiler 80.0 (2.) 122.1 (1.) 247.8 (5.)
 Trefferlage 0.97 mm rechts, 1.51 mm tief
 Streuwert 1.97, horizontal: 1.40, vertikal: 2.41

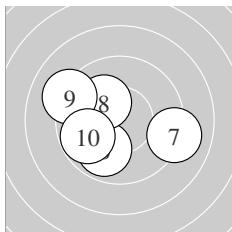

Serie 2:
 9.9 ↙ 9.1 → 10.2 * 9.1 ↖ 9.8 ←
 beste Teiler 193.5 (8.) 267.0 (6.) 293.3 (10.)
 Trefferlage 0.95 mm links, 0.30 mm tief
 Streuwert 2.66, horizontal: 3.26, vertikal: 1.88

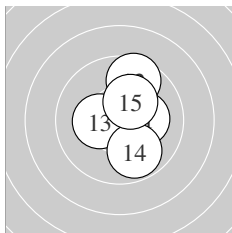

Serie 3:
 10.2 * 9.6 ↑ 10.3 * 9.8 ↘ 10.3 *
 beste Teiler 163.3 (13.) 173.9 (15.) 187.3 (11.)
 Trefferlage 0.69 mm rechts, 0.44 mm hoch
 Streuwert 1.78, horizontal: 1.35, vertikal: 2.12

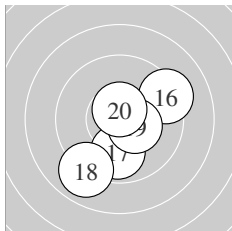

Serie 4:
 9.3 → 9.9 ↓ 9.0 ↙ 10.4 * 10.6 *
 beste Teiler 79.0 (20.) 137.3 (19.) 268.4 (17.)
 Trefferlage 0.42 mm rechts, 0.95 mm tief
 Streuwert 2.42, horizontal: 2.38, vertikal: 2.47

Unterschrift des Schützen

Meyton Elektronik

Ergebnis: **196** (200.9)
 Serien: 49 50 49 48
 Zähler: 17 2 1 0 0 0 0 0 0 0
 Innenzehner: 10
 weiteste: 630 (17), 429 (5), 378 (13)
 beste Teiler 104.2 (14.) 111.8 (10.) 124.0 (19.)
 Trefferlage 0.91 mm links, 0.02 mm hoch
 Streuwert 1.75, horizontal: 1.37, vertikal: 2.05

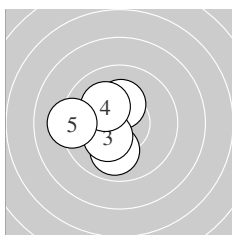
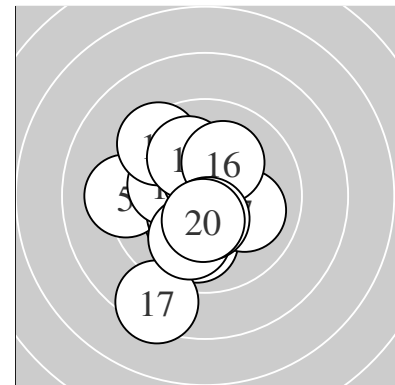

Serie 1:
 10.3 * 10.0 ↓ 10.3 * 10.2 * 9.2 ←
 beste Teiler 160.8 (3.) 170.4 (1.) 197.1 (4.)
 Trefferlage 1.39 mm links, 0.09 mm tief
 Streuwert 1.74, horizontal: 1.71, vertikal: 1.77

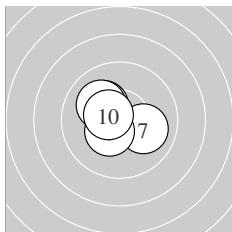

Serie 2:
 10.2 * 10.0 → 10.4 * 10.1 ↘ 10.5 *
 beste Teiler 111.8 (10.) 135.2 (8.) 196.7 (6.)
 Trefferlage 0.58 mm links, 0.28 mm hoch
 Streuwert 1.36, horizontal: 1.55, vertikal: 1.13

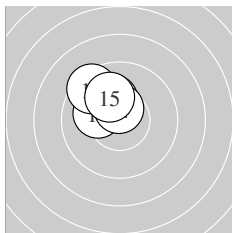

Serie 3:
 10.2 * 10.1 ↖ 9.4 ↖ 10.5 * 10.1 ↖
 beste Teiler 104.2 (14.) 195.4 (11.) 205.5 (12.)
 Trefferlage 1.21 mm links, 1.68 mm hoch
 Streuwert 0.94, horizontal: 1.01, vertikal: 0.87

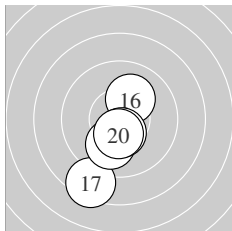

Serie 4:
 10.1 ↗ 8.4 ↓ 10.0 ↓ 10.5 * 10.4 *
 beste Teiler 124.0 (19.) 133.3 (20.) 205.3 (16.)
 Trefferlage 0.48 mm links, 1.75 mm tief
 Streuwert 2.14, horizontal: 1.35, vertikal: 2.71

Unterschrift des Schützen

Meyton Elektronik

Ergebnis:	188	(195.4)
Serien:	47 49 47 45	
Zähler:	10 8 2 0 0 0 0 0 0 0	
Innenzehner:	5	
weiteste:	680 (12), 544 (16), 460 (5)	
beste Teiler	73.1 (15.) 138.8 (13.) 151.5 (18.)	
Trefferlage	0.73 mm rechts, 0.73 mm hoch	
Streuwert	2.27, horizontal: 2.65, vertikal: 1.81	

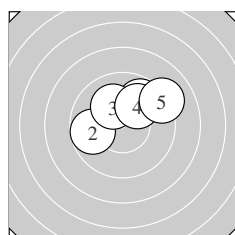
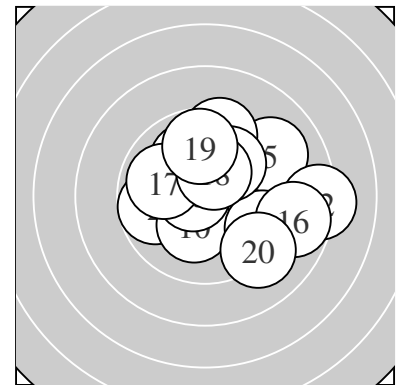

Serie 1:	9.8 ↗	9.7 ←	10.1 ↘	10.0 ↗	9.1 ↗
beste Teiler	207.9 (3.)	239.4 (4.)	293.2 (1.)		
Trefferlage	0.63 mm rechts, 1.58 mm hoch				
Streuwert	2.08, horizontal: 2.65, vertikal: 1.27				

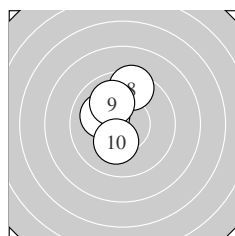

Serie 2:	10.3 *	10.1 ↖	9.5 ↑	10.0 ↘	10.2 *
beste Teiler	172.1 (6.)	184.8 (10.)	216.9 (7.)		
Trefferlage	0.87 mm links, 1.12 mm hoch				
Streuwert	1.59, horizontal: 1.10, vertikal: 1.97				

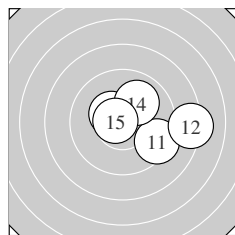

Serie 3:	9.4 ↘	8.2 →	10.4 *	10.0 ↗	10.7 *
beste Teiler	73.1 (15.)	138.8 (13.)	237.6 (14.)		
Trefferlage	1.95 mm rechts, 0.11 mm hoch				
Streuwert	2.51, horizontal: 3.26, vertikal: 1.43				

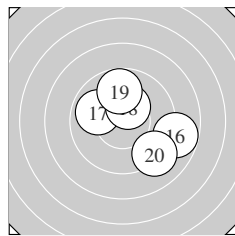

Serie 4:	8.8 →	9.9 ↖	10.3 *	9.8 ↑	9.1 ↘
beste Teiler	151.5 (18.)	259.9 (17.)	297.6 (19.)		
Trefferlage	1.24 mm rechts, 0.12 mm hoch				
Streuwert	2.75, horizontal: 3.02, vertikal: 2.45				

Unterschrift des Schützen

Meyton Elektronik

Ergebnis: **197** (205.0)
 Serien: 50 49 49 49
 Zähler: 17 3 0 0 0 0 0 0 0 0
 Innenzehner: 14
 weiteste: 399 (15), 362 (18), 279 (6)
 beste Teiler 74.8 (8.) 77.8 (11.) 87.5 (12.)
 Trefferlage 0.75 mm links, 0.37 mm hoch
 Streuwert 1.30, horizontal: 1.60, vertikal: 0.90

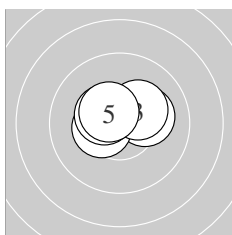
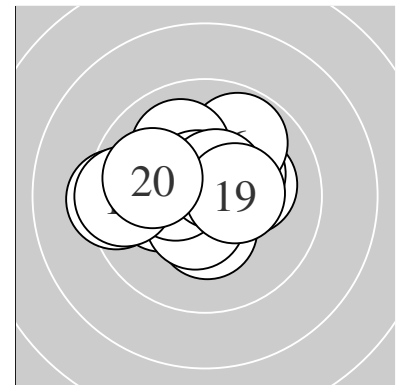

Serie 1:
 10.2 * 10.4 * 10.3 * 10.4 * 10.5 *
 beste Teiler 116.0 (5.) 129.7 (4.) 137.2 (2.)
 Trefferlage 0.00 mm , 0.52 mm hoch
 Streuwert 1.13, horizontal: 1.51, vertikal: 0.52

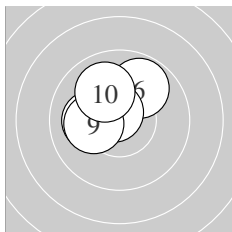

Serie 2:
 9.8 ↗ 10.1 ← 10.7 * 10.2 * 10.0 ↖
 beste Teiler 74.8 (8.) 194.7 (9.) 209.0 (7.)
 Trefferlage 0.82 mm links, 0.95 mm hoch
 Streuwert 1.33, horizontal: 1.44, vertikal: 1.22

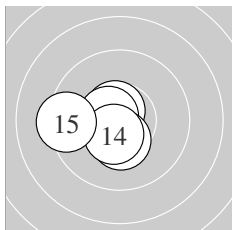

Serie 3:
 10.6 * 10.6 * 10.4 * 10.5 * 9.4 ←
 beste Teiler 77.8 (11.) 87.5 (12.) 114.7 (14.)
 Trefferlage 1.10 mm links, 0.34 mm tief
 Streuwert 1.33, horizontal: 1.65, vertikal: 0.91

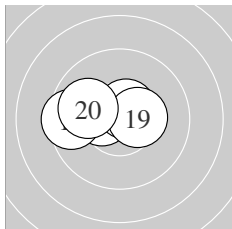

Serie 4:
 10.4 * 10.6 * 9.5 ← 10.4 * 10.0 ↖
 beste Teiler 89.0 (17.) 134.1 (16.) 134.5 (19.)
 Trefferlage 1.09 mm links, 0.37 mm hoch
 Streuwert 1.46, horizontal: 2.03, vertikal: 0.37

Unterschrift des Schützen

Meyton Elektronik

Ergebnis: **193** (199.9)
 Serien: 48 47 49 49
 Zähler: 13 7 0 0 0 0 0 0 0 0
 Innenzehner: 6
 weiteste: 441 (3), 424 (1), 386 (7)
 beste Teiler 66.1 (19.) 68.5 (6.) 97.0 (2.)
 Trefferlage 0.35 mm links, 0.92 mm tief
 Streuwert 1.76, horizontal: 2.05, vertikal: 1.41

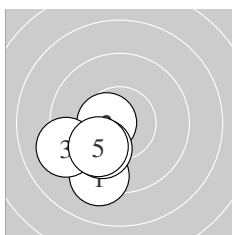
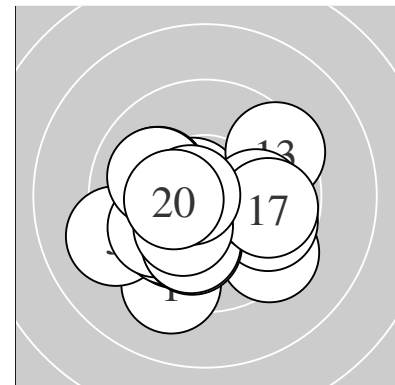

Serie 1:
 9.3 ↙ 10.6 * 9.2 ↙ 10.0 ↙ 10.0 ↙
 beste Teiler 97.0 (2.) 232.4 (4.) 238.5 (5.)
 Trefferlage 1.88 mm links, 1.88 mm tief
 Streuwert 1.32, horizontal: 1.22, vertikal: 1.42

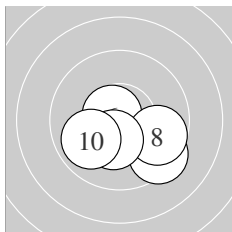

Serie 2:
 10.7 * 9.4 ↘ 9.7 ↘ 10.3 * 9.9 ↙
 beste Teiler 68.5 (6.) 154.9 (9.) 258.2 (10.)
 Trefferlage 0.51 mm rechts, 1.24 mm tief
 Streuwert 1.76, horizontal: 2.25, vertikal: 1.05

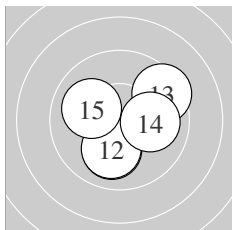

Serie 3:
 10.0 ↙ 10.1 ↙ 9.5 ↗ 10.0 → 10.0 ↖
 beste Teiler 223.0 (12.) 228.2 (15.) 228.4 (11.)
 Trefferlage 0.43 mm rechts, 0.32 mm tief
 Streuwert 2.04, horizontal: 2.21, vertikal: 1.85

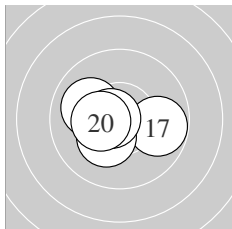

Serie 4:
 10.0 ↖ 9.8 → 10.3 * 10.7 * 10.4 *
 beste Teiler 66.1 (19.) 141.9 (20.) 168.2 (18.)
 Trefferlage 0.47 mm links, 0.23 mm tief
 Streuwert 1.49, horizontal: 1.94, vertikal: 0.81

Unterschrift des Schützen

Ergebnis: **185** (191.6)
 Serien: 46 46 45 48
 Zähler: 11 5 2 2 0 0 0 0 0 0
 Innenzehner: 7
 weiteste: 845 (3), 810 (11), 655 (19)
 beste Teiler 81.6 (18.) 107.2 (14.) 128.4 (5.)
 Trefferlage 0.18 mm links, 1.37 mm tief
 Streuwert 2.78, horizontal: 2.82, vertikal: 2.74

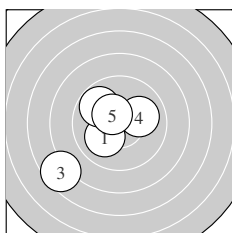
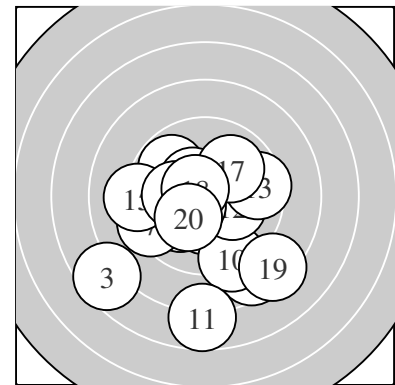

Serie 1:
 10.1 ↙ 9.8 ↘ 7.6 ↙ 10.0 → 10.4 *
 beste Teiler 128.4 (5.) 221.5 (1.) 228.0 (4.)
 Trefferlage 1.81 mm links, 0.66 mm tief
 Streuwert 3.02, horizontal: 3.13, vertikal: 2.90

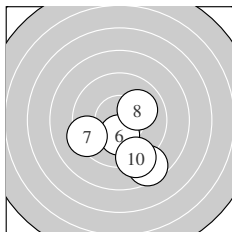

Serie 2:
 10.3 * 9.3 ↙ 10.0 → 8.6 ↘ 9.2 ↘
 beste Teiler 165.0 (6.) 227.6 (8.) 403.8 (7.)
 Trefferlage 0.64 mm rechts, 2.29 mm tief
 Streuwert 2.53, horizontal: 2.64, vertikal: 2.42

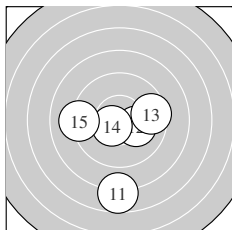

Serie 3:
 7.7 ↓ 10.2 * 9.5 → 10.5 * 9.1 ←
 beste Teiler 107.2 (14.) 195.5 (12.) 357.7 (13.)
 Trefferlage 0.04 mm links, 1.76 mm tief
 Streuwert 3.32, horizontal: 3.03, vertikal: 3.58

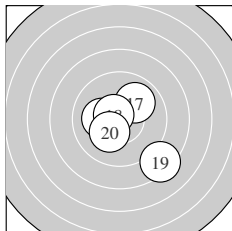

Serie 4:
 10.2 * 10.0 ↗ 10.6 * 8.3 ↘ 10.2 *
 beste Teiler 81.6 (18.) 181.6 (20.) 197.1 (16.)
 Trefferlage 0.49 mm rechts, 0.76 mm tief
 Streuwert 2.57, horizontal: 2.63, vertikal: 2.51

Unterschrift des Schützen

Ergebnis: **192** (199.5)
 Serien: 49 48 48 47
 Zähler: 14 4 2 0 0 0 0 0 0 0
 Innenzehner: 8
 weiteste: 588 (16), 543 (10), 419 (13)
 beste Teiler 13.1 (6.) 57.4 (8.) 79.0 (1.)
 Trefferlage 0.31 mm links, 0.42 mm hoch
 Streuwert 2.05, horizontal: 2.21, vertikal: 1.88

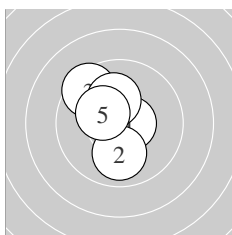
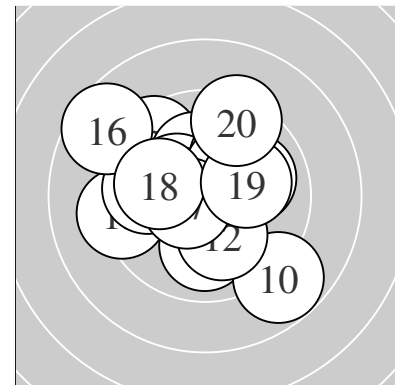

Serie 1:
 10.6 * 10.0 ↓ 9.5 ↘ 10.2 * 10.3 *
 beste Teiler 79.0 (1.) 162.4 (5.) 196.9 (4.)
 Trefferlage 0.72 mm links, 0.59 mm hoch
 Streuwert 1.68, horizontal: 1.28, vertikal: 2.00

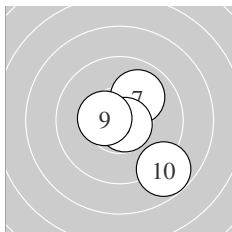

Serie 2:
 10.9 * 10.0 ↗ 10.7 * 10.5 * 8.8 ↘
 beste Teiler 13.1 (6.) 57.4 (8.) 123.9 (9.)
 Trefferlage 0.86 mm rechts, 0.44 mm tief
 Streuwert 2.02, horizontal: 1.83, vertikal: 2.19

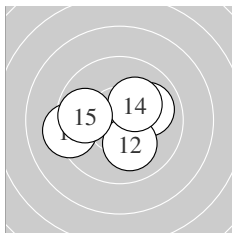

Serie 3:
 10.0 → 10.1 ↓ 9.3 ← 10.2 * 9.8 ←
 beste Teiler 181.0 (14.) 210.4 (12.) 243.4 (11.)
 Trefferlage 0.51 mm links, 0.04 mm tief
 Streuwert 2.18, horizontal: 2.79, vertikal: 1.33

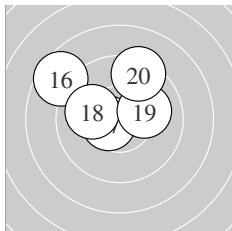

Serie 4:
 8.6 ↘ 10.6 * 10.0 ← 10.1 → 9.3 ↗
 beste Teiler 96.9 (17.) 214.7 (19.) 233.8 (18.)
 Trefferlage 0.88 mm links, 1.59 mm hoch
 Streuwert 2.38, horizontal: 2.84, vertikal: 1.82

Unterschrift des Schützen

Meyton Elektronik

Ergebnis: **191** (199.1)
 Serien: 50 45 49 47
 Zähler: 13 5 2 0 0 0 0 0 0 0
 Innenzehner: 12
 weiteste: 583 (10), 543 (17), 475 (7)
 beste Teiler 45.5 (16.) 91.2 (3.) 104.4 (18.)
 Trefferlage 0.13 mm links, 0.77 mm tief
 Streuwert 2.04, horizontal: 1.94, vertikal: 2.13

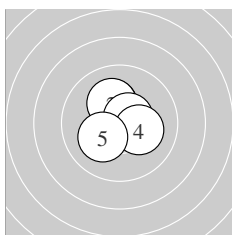
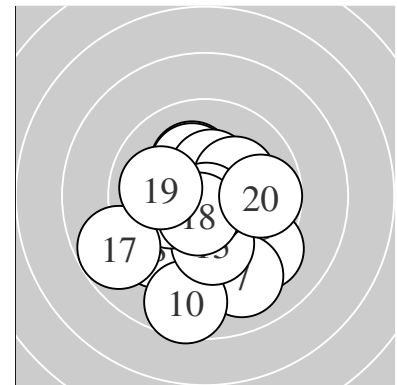

Serie 1:
 10.2 * 10.2 * 10.6 * 10.2 * 10.2 *
 beste Teiler 91.2 (3.) 184.0 (4.) 184.8 (1.)
 Trefferlage 0.07 mm links, 0.43 mm hoch
 Streuwert 1.33, horizontal: 1.31, vertikal: 1.36

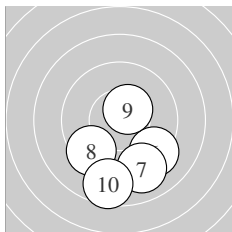

Serie 2:
 9.3 ↘ 9.1 ↘ 9.5 ↙ 10.5 * 8.6 ↓
 beste Teiler 122.0 (9.) 375.7 (8.) 421.7 (6.)
 Trefferlage 0.44 mm rechts, 2.94 mm tief
 Streuwert 2.39, horizontal: 2.28, vertikal: 2.50

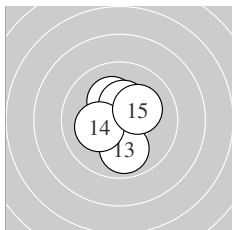

Serie 3:
 10.2 * 10.4 * 9.9 ↓ 10.2 * 10.2 *
 beste Teiler 139.2 (12.) 183.3 (11.) 187.9 (15.)
 Trefferlage 0.03 mm links, 0.16 mm hoch
 Streuwert 1.55, horizontal: 1.29, vertikal: 1.76

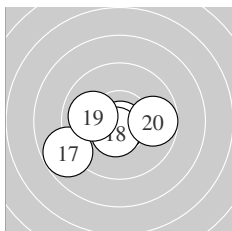

Serie 4:
 10.8 * 8.8 ↙ 10.5 * 10.0 ← 9.7 →
 beste Teiler 45.5 (16.) 104.4 (18.) 244.0 (19.)
 Trefferlage 0.87 mm links, 0.75 mm tief
 Streuwert 2.21, horizontal: 2.87, vertikal: 1.25

Unterschrift des Schützen

Meyton Elektronik

Ergebnis:	179	(185.9)
Serien:	48 46 39 46	
Zähler:	7 8 4 0 0 1 0 0 0 0	
Innenzehner:	2	
weiteste:	1354 (12), 690 (10), 651 (14)	
beste Teiler	95.1 (1.) 130.3 (4.) 222.7 (16.)	
Trefferlage	0.65 mm links, 0.13 mm hoch	
Streuwert	3.55, horizontal: 4.14, vertikal: 2.85	

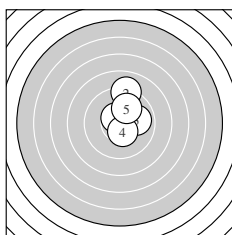
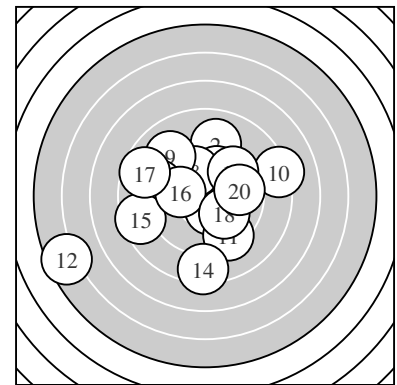

Serie 1:	10.6 *	9.1 ↑	9.9 →	10.4 *	10.0 ↗
beste Teiler	95.1 (1.)	130.3 (4.)	242.4 (5.)		
Trefferlage	0.88 mm rechts, 1.36 mm hoch				
Streuwert	1.73, horizontal: 1.09, vertikal: 2.18				

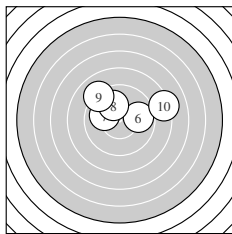

Serie 2:	9.8 →	10.0 ←	10.0 ↖	9.1 ↘	8.2 →
beste Teiler	234.9 (7.)	236.6 (8.)	282.2 (6.)		
Trefferlage	0.62 mm rechts, 1.79 mm hoch				
Streuwert	2.97, horizontal: 4.02, vertikal: 1.25				

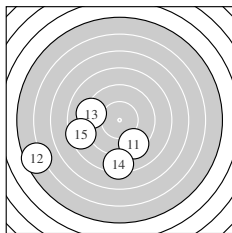

Serie 3:	9.3 ↘	5.5 ←	9.2 ←	8.3 ↓	8.5 ←
beste Teiler	408.0 (11.)	431.5 (13.)	609.7 (15.)		
Trefferlage	4.07 mm links, 3.34 mm tief				
Streuwert	4.47, horizontal: 5.56, vertikal: 2.99				

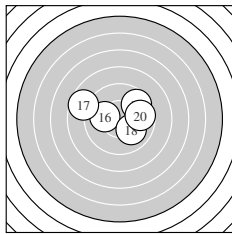

Serie 4:	10.1 ←	8.6 ←	10.0 ↘	9.6 ↗	9.7 →
beste Teiler	222.7 (16.)	231.4 (18.)	310.7 (20.)		
Trefferlage	0.06 mm links, 0.71 mm hoch				
Streuwert	2.77, horizontal: 3.61, vertikal: 1.53				

Unterschrift des Schützen

Ergebnis: **185** (193.6)
 Serien: 48 45 48 44
 Zähler: 8 9 3 0 0 0 0 0 0 0
 Innenzehner: 6
 weiteste: 671 (8), 647 (7), 503 (20)
 beste Teiler 113.3 (3.) 126.1 (10.) 128.8 (9.)
 Trefferlage 0.03 mm links, 0.04 mm tief
 Streuwert 2.62, horizontal: 3.04, vertikal: 2.11

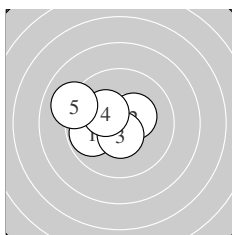
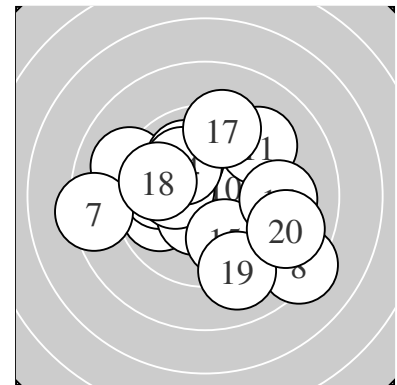

Serie 1:
 9.8 ← 10.4 * 10.5 * 10.3 * 9.1 ↖
 beste Teiler 113.3 (3.) 148.9 (2.) 165.4 (4.)
 Trefferlage 1.37 mm links, 0.25 mm hoch
 Streuwert 1.81, horizontal: 2.23, vertikal: 1.24

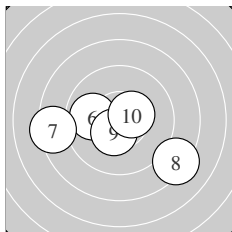

Serie 2:
 9.9 ← 8.4 ← 8.3 ↘ 10.4 * 10.4 *
 beste Teiler 126.1 (10.) 128.8 (9.) 260.2 (6.)
 Trefferlage 0.59 mm links, 1.03 mm tief
 Streuwert 3.35, horizontal: 4.39, vertikal: 1.80

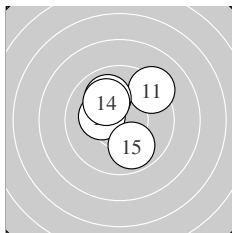

Serie 3:
 9.3 ↗ 10.3 * 10.0 ↖ 10.1 ↖ 9.9 ↘
 beste Teiler 174.5 (12.) 215.2 (14.) 241.5 (13.)
 Trefferlage 0.01 mm rechts, 0.93 mm hoch
 Streuwert 2.07, horizontal: 2.04, vertikal: 2.10

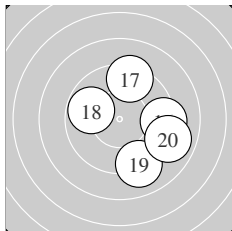

Serie 4:
 9.3 → 9.4 ↑ 9.8 ← 9.1 ↘ 8.9 →
 beste Teiler 285.6 (18.) 399.2 (17.) 423.4 (16.)
 Trefferlage 1.79 mm rechts, 0.34 mm tief
 Streuwert 3.01, horizontal: 2.97, vertikal: 3.06

Unterschrift des Schützen

Ergebnis: **175** (183.9)
 Serien: 45 43 41 46
 Zähler: 5 8 5 1 1 0 0 0 0 0
 Innenzehner: 3
 weiteste: 1045 (15), 788 (9), 734 (3)
 beste Teiler 134.3 (1.) 170.8 (19.) 176.5 (20.)
 Trefferlage 0.88 mm links, 0.68 mm tief
 Streuwert 3.53, horizontal: 3.90, vertikal: 3.11

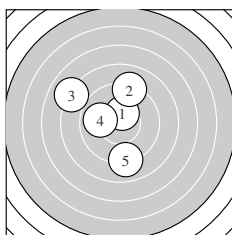
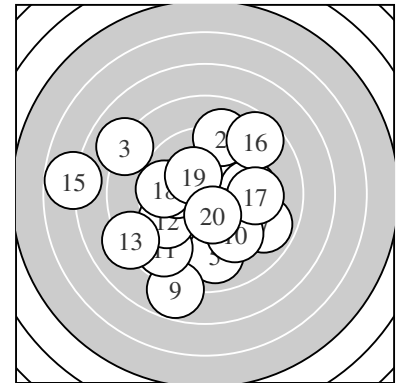

Serie 1:
 10.4 * 9.1 ↗ 8.0 ↘ 9.9 ← 9.0 ↓
 beste Teiler 134.3 (1.) 257.2 (4.) 462.3 (2.)
 Trefferlage 1.28 mm links, 1.01 mm hoch
 Streuwert 3.43, horizontal: 3.19, vertikal: 3.65

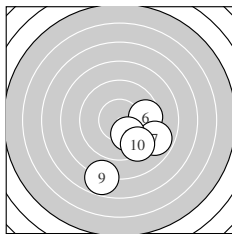

Serie 2:
 9.6 → 8.9 ↘ 10.1 ↓ 7.8 ↓ 9.4 ↓
 beste Teiler 211.1 (8.) 343.5 (6.) 392.2 (10.)
 Trefferlage 1.82 mm rechts, 2.89 mm tief
 Streuwert 2.80, horizontal: 2.67, vertikal: 2.91

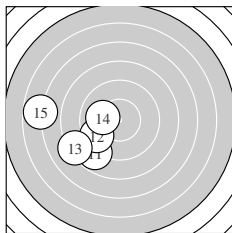

Serie 3:
 8.8 ↙ 9.5 ↙ 8.2 ↙ 10.1 ← 6.8 ←
 beste Teiler 223.6 (14.) 363.0 (12.) 534.6 (11.)
 Trefferlage 4.94 mm links, 1.70 mm tief
 Streuwert 2.89, horizontal: 3.35, vertikal: 2.36

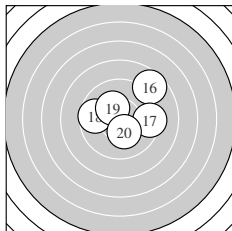

Serie 4:
 8.7 ↗ 9.4 → 9.7 ← 10.3 * 10.2 *
 beste Teiler 170.8 (19.) 176.5 (20.) 324.3 (18.)
 Trefferlage 0.87 mm rechts, 0.84 mm hoch
 Streuwert 2.69, horizontal: 3.12, vertikal: 2.18

Unterschrift des Schützen

Meyton Elektronik

Ergebnis: **196** (203.0)
 Serien: 49 50 49 48
 Zähler: 16 4 0 0 0 0 0 0 0 0
 Innenzehner: 11
 weiteste: 359 (3), 337 (20), 278 (17)
 beste Teiler 72.2 (7.) 79.7 (16.) 129.4 (10.)
 Trefferlage 0.34 mm rechts, 0.31 mm hoch
 Streuwert 1.51, horizontal: 1.68, vertikal: 1.31

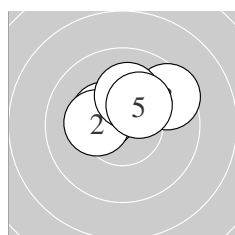
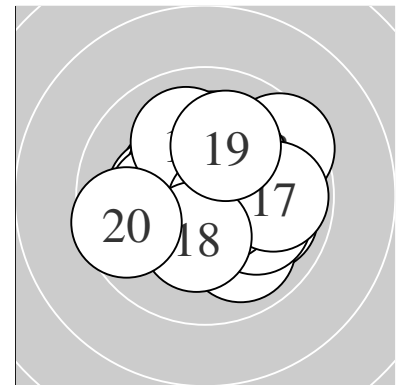

Serie 1:
 10.4 * 10.3 * 9.5 ↗ 10.1 ↑ 10.2 *
 beste Teiler 144.9 (1.) 174.7 (2.) 176.1 (5.)
 Trefferlage 0.29 mm rechts, 1.22 mm hoch
 Streuwert 1.47, horizontal: 1.92, vertikal: 0.80

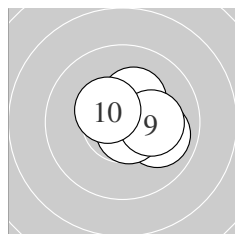

Serie 2:
 10.0 ↘ 10.7 * 10.3 * 10.2 * 10.4 *
 beste Teiler 72.2 (7.) 129.4 (10.) 166.3 (8.)
 Trefferlage 0.89 mm rechts, 0.16 mm hoch
 Streuwert 1.17, horizontal: 1.33, vertikal: 0.97

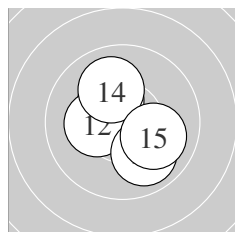

Serie 3:
 10.3 * 10.3 * 9.9 ↘ 10.0 ↑ 10.0 ↘
 beste Teiler 165.6 (11.) 173.3 (12.) 229.9 (15.)
 Trefferlage 0.04 mm rechts, 0.09 mm hoch
 Streuwert 1.69, horizontal: 1.64, vertikal: 1.74

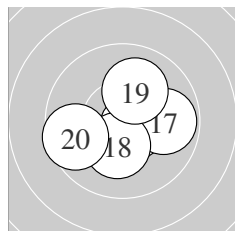

Serie 4:
 10.6 * 9.8 → 10.3 * 10.1 ↑ 9.6 ←
 beste Teiler 79.7 (16.) 169.6 (18.) 220.6 (19.)
 Trefferlage 0.15 mm rechts, 0.22 mm tief
 Streuwert 1.84, horizontal: 2.19, vertikal: 1.41

Unterschrift des Schützen

Ergebnis:	179	(190.5)
Serien:	47	45 44 43
Zähler:	4	11 5 0 0 0 0 0 0 0
Innenzehner:	4	
weiteste:	676 (15), 561 (14), 559 (18)	
beste Teiler	5.0 (4.)	117.6 (11.) 148.9 (1.)
Trefferlage	0.06 mm links, 0.45 mm hoch	
Streuwert	2.84, horizontal: 3.32, vertikal: 2.26	

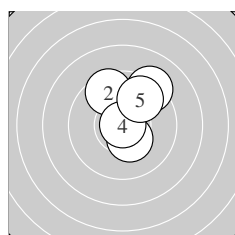
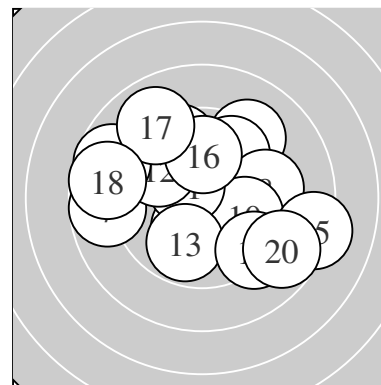

Serie 1:	10.4 *	9.6 ↖	9.2 ↗	10.9 *	9.7 ↗
beste Teiler	5.0 (4.)	148.9 (1.)	303.9 (5.)		
Trefferlage	0.73 mm rechts, 1.58 mm hoch				
Streuwert	1.85, horizontal: 1.54, vertikal: 2.11				

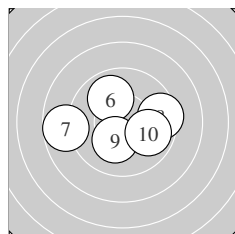

Serie 2:	9.9 ↖	8.7 ←	9.5 →	10.2 *	9.9 →
beste Teiler	185.5 (9.)	255.8 (6.)	268.1 (10.)		
Trefferlage	0.24 mm links, 0.09 mm tief				
Streuwert	2.77, horizontal: 3.59, vertikal: 1.56				

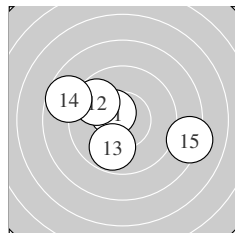

Serie 3:	10.5 *	9.7 ↖	9.8 ↓	8.7 ↖	8.2 →
beste Teiler	117.6 (11.)	278.2 (13.)	305.4 (12.)		
Trefferlage	0.63 mm links, 0.00 mm				
Streuwert	3.42, horizontal: 4.35, vertikal: 2.13				

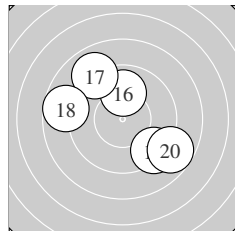

Serie 4:	9.9 ↑	9.0 ↖	8.7 ←	9.2 ↘	8.8 ↘
beste Teiler	252.0 (16.)	428.5 (19.)	499.2 (17.)		
Trefferlage	0.09 mm links, 0.34 mm hoch				
Streuwert	3.72, horizontal: 4.12, vertikal: 3.26				

Unterschrift des Schützen

Meyton Elektronik

Ergebnis: **187** (195.8)
 Serien: 50 47 46 44
 Zähler: 10 7 3 0 0 0 0 0 0 0
 Innenzehner: 8
 weiteste: 580 (17), 553 (20), 513 (11)
 beste Teiler 84.3 (3.) 96.1 (9.) 113.8 (18.)
 Trefferlage 0.48 mm links, 0.55 mm hoch
 Streuwert 2.37, horizontal: 2.92, vertikal: 1.64

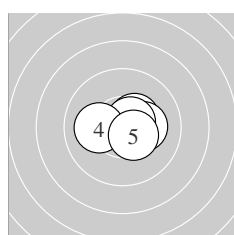
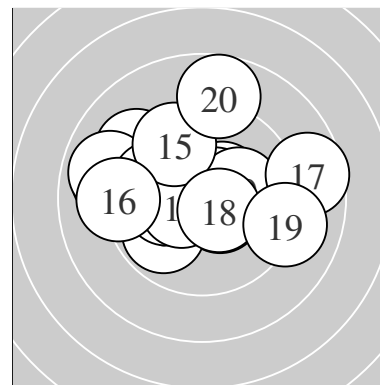

Serie 1:
 10.4 * 10.2 * 10.6 * 10.1 ← 10.5 *
 beste Teiler 84.3 (3.) 120.8 (5.) 132.4 (1.)
 Trefferlage 0.48 mm rechts, 0.10 mm hoch
 Streuwert 1.14, horizontal: 1.50, vertikal: 0.57

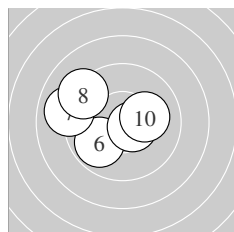

Serie 2:
 9.9 ↙ 9.0 ← 9.2 ↘ 10.6 * 10.1 →
 beste Teiler 96.1 (9.) 203.5 (10.) 274.3 (6.)
 Trefferlage 1.50 mm links, 0.35 mm hoch
 Streuwert 2.33, horizontal: 2.87, vertikal: 1.61

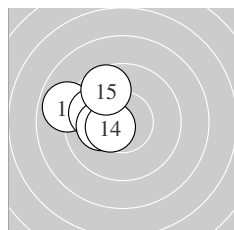

Serie 3:
 8.9 ↖ 9.9 ↖ 10.2 * 10.5 * 9.7 ↗
 beste Teiler 118.4 (14.) 194.4 (13.) 272.6 (12.)
 Trefferlage 2.41 mm links, 0.86 mm hoch
 Streuwert 1.44, horizontal: 1.52, vertikal: 1.36

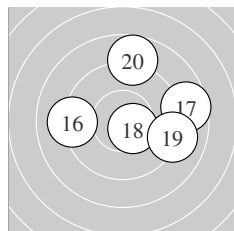

Serie 4:
 9.1 ← 8.6 → 10.5 * 9.1 → 8.7 ↑
 beste Teiler 113.8 (18.) 451.0 (16.) 469.6 (19.)
 Trefferlage 1.49 mm rechts, 0.90 mm hoch
 Streuwert 3.41, horizontal: 3.97, vertikal: 2.73

Unterschrift des Schützen

Meyton Elektronik

Ergebnis:	180	(186.4)
Serien:	46 46 44 44	
Zähler:	6 10 3 0 1 0 0 0 0 0	
Innenzehner:	3	
weiteste:	1147 (15), 743 (18), 625 (8)	
beste Teiler	95.6 (14.) 159.3 (20.) 166.3 (13.)	
Trefferlage	2.20 mm links, 0.38 mm tief	
Streuwert	3.01, horizontal: 3.30, vertikal: 2.69	

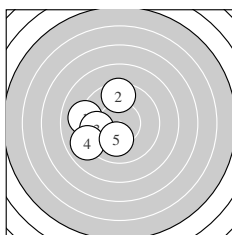
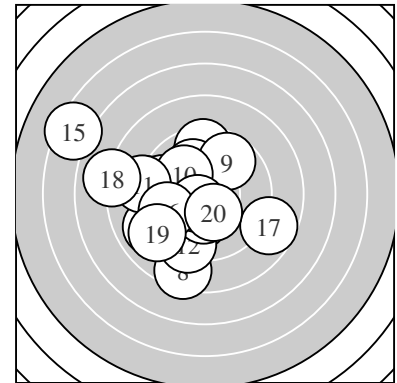

Serie 1:

9.1 ←	9.5 ↑	9.7 ←	9.0 ↙	10.1 ↓
beste Teiler	212.1 (5.)	307.3 (3.)	364.3 (2.)	
Trefferlage	2.46 mm links, 0.20 mm tief			
Streuwert	2.29, horizontal: 2.07, vertikal: 2.50			

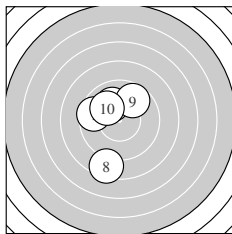

Serie 2:

10.0 ↖	9.6 ←	8.5 ↓	9.7 ↗	10.0 ↖
beste Teiler	227.2 (6.)	227.7 (10.)	307.8 (9.)	
Trefferlage	1.20 mm links, 0.19 mm hoch			
Streuwert	2.82, horizontal: 1.86, vertikal: 3.53			

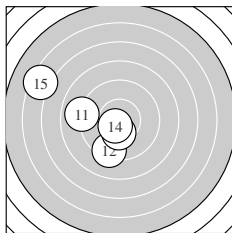

Serie 3:

9.0 ←	9.3 ↓	10.3 *	10.6 *	6.4 ↖
beste Teiler	95.6 (14.)	166.3 (13.)	418.0 (12.)	
Trefferlage	3.47 mm links, 0.13 mm tief			
Streuwert	3.83, horizontal: 4.29, vertikal: 3.31			

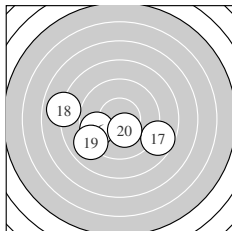

Serie 4:

9.6 ←	8.7 ↘	8.0 ←	9.0 ↙	10.3 *
beste Teiler	159.3 (20.)	326.3 (16.)	484.9 (19.)	
Trefferlage	1.68 mm links, 1.41 mm tief			
Streuwert	3.52, horizontal: 4.70, vertikal: 1.66			

Unterschrift des Schützen

Meyton Elektronik

Ergebnis: **195** (205.2)
 Serien: 49 50 49 47
 Zähler: 15 5 0 0 0 0 0 0 0 0
 Innenzehner: 14
 weiteste: 321 (19), 309 (15), 285 (18)
 beste Teiler 76.9 (1.) 86.3 (9.) 88.4 (17.)
 Trefferlage 0.00 mm , 0.35 mm tief
 Streuwert 1.35, horizontal: 1.55, vertikal: 1.13

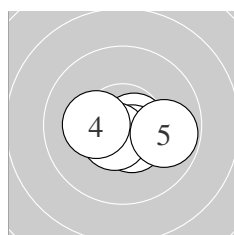
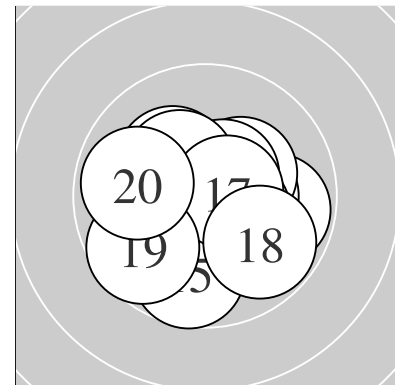

Serie 1:
 10.6 * 10.5 * 10.6 * 10.3 * 9.8 →
 beste Teiler 76.9 (1.) 91.8 (3.) 109.2 (2.)
 Trefferlage 0.37 mm rechts, 0.45 mm tief
 Streuwert 1.22, horizontal: 1.67, vertikal: 0.40

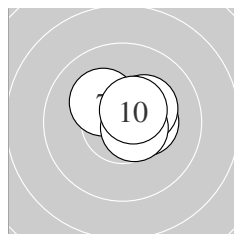

Serie 2:
 10.4 * 10.2 * 10.3 * 10.6 * 10.5 *
 beste Teiler 86.3 (9.) 106.9 (10.) 148.0 (6.)
 Trefferlage 0.62 mm rechts, 0.53 mm hoch
 Streuwert 0.94, horizontal: 1.12, vertikal: 0.70

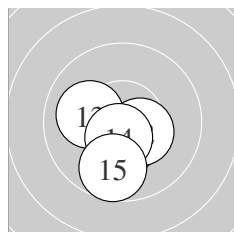

Serie 3:
 10.4 * 10.4 * 10.1 ← 10.5 * 9.7 ↓
 beste Teiler 105.2 (14.) 128.7 (11.) 132.9 (12.)
 Trefferlage 0.35 mm links, 1.09 mm tief
 Streuwert 1.25, horizontal: 1.22, vertikal: 1.28

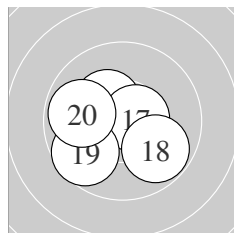

Serie 4:
 10.3 * 10.6 * 9.8 ↘ 9.7 ↙ 9.9 ←
 beste Teiler 88.4 (17.) 154.5 (16.) 274.7 (20.)
 Trefferlage 0.62 mm links, 0.41 mm tief
 Streuwert 1.82, horizontal: 2.12, vertikal: 1.45

Unterschrift des Schützen