

Ergebnis: **307.0** (294)  
 Serien: 103.3 102.0 101.7  
 Zähler: 24 6 0 0 0 0 0 0 0 0  
 Innenzehner: 21  
 weiteste: 407 (28), 325 (12), 300 (21)  
 beste Teiler 41.0 (22.) 58.1 (26.) 76.3 (4.)  
 Trefferlage 0.33 mm links, 0.22 mm hoch  
 Streuwert 1.39, horizontal: 1.66, vertikal: 1.07

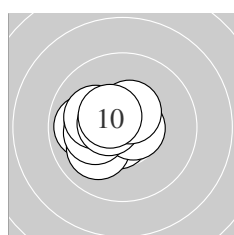

Serie 1:  
 10.6 \*                      9.9 ←                      10.1 ↙                      10.6 \*                      10.2 \*  
 10.2 \*                      10.1 ↖                      10.6 \*                      10.5 \*                      10.5 \*  
 beste Teiler 76.3 (4.) 78.7 (1.) 99.9 (8.)  
 Trefferlage 1.10 mm links, 0.04 mm hoch  
 Streuwert 0.95, horizontal: 1.12, vertikal: 0.75

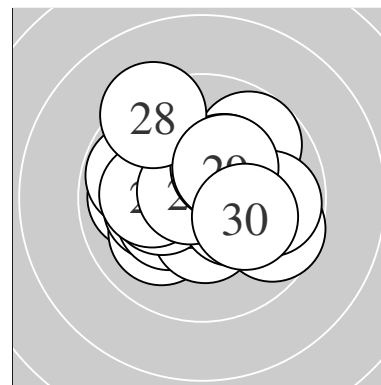
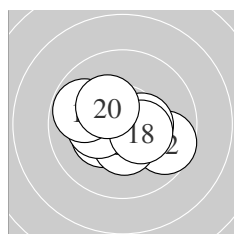

Serie 2:  
 10.3 \*                      9.7 →                      10.2 \*                      10.4 \*                      10.2 \*  
 10.4 \*                      10.3 \*                      10.4 \*                      9.8 ↖                      10.3 \*  
 beste Teiler 134.0 (14.) 136.6 (16.) 140.2 (18.)  
 Trefferlage 0.46 mm links, 0.09 mm tief  
 Streuwert 1.44, horizontal: 1.82, vertikal: 0.91

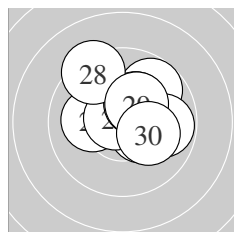

Serie 3:  
 9.8 ↗                      10.8 \*                      10.4 \*                      9.8 →                      10.1 ←  
 10.7 \*                      10.3 \*                      9.3 ↘                      10.3 \*                      10.2 \*  
 beste Teiler 41.0 (22.) 58.1 (26.) 145.7 (23.)  
 Trefferlage 0.54 mm rechts, 0.73 mm hoch  
 Streuwert 1.52, horizontal: 1.66, vertikal: 1.36

Unterschrift des Schützen

Ergebnis: **316.3** (300)  
 Serien: 105.8 105.6 104.9  
 Zähler: 30 0 0 0 0 0 0 0 0 0  
 Innenzehner: 30  
 weiteste: 199 (23), 192 (18), 177 (22)  
 beste Teiler 40.2 (6.) 43.6 (2.) 49.3 (13.)  
 Trefferlage 0.00 mm , 0.29 mm tief  
 Streuwert 0.77, horizontal: 0.88, vertikal: 0.65

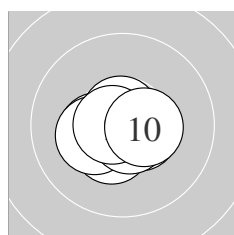
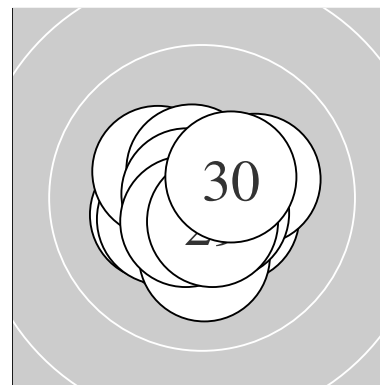

Serie 1:  
 10.4 \*                      10.8 \*                      10.4 \*                      10.5 \*                      10.3 \*  
 10.8 \*                      10.7 \*                      10.7 \*                      10.7 \*                      10.5 \*  
 beste Teiler 40.2 (6.) 43.6 (2.) 57.2 (8.)  
 Trefferlage 0.18 mm links, 0.25 mm tief  
 Streuwert 0.74, horizontal: 0.94, vertikal: 0.45

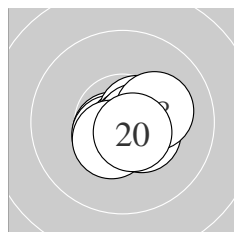

Serie 2:  
 10.6 \*                      10.6 \*                      10.8 \*                      10.6 \*                      10.4 \*  
 10.7 \*                      10.6 \*                      10.2 \*                      10.5 \*                      10.6 \*  
 beste Teiler 49.3 (13.) 55.4 (16.) 77.1 (17.)  
 Trefferlage 0.37 mm rechts, 0.32 mm tief  
 Streuwert 0.69, horizontal: 0.82, vertikal: 0.51

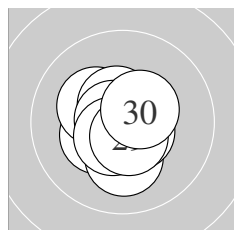

Serie 3:  
 10.3 \*                      10.2 \*                      10.2 \*                      10.7 \*                      10.5 \*  
 10.7 \*                      10.6 \*                      10.6 \*                      10.6 \*                      10.5 \*  
 beste Teiler 53.8 (26.) 75.1 (24.) 88.6 (29.)  
 Trefferlage 0.20 mm links, 0.28 mm tief  
 Streuwert 0.89, horizontal: 0.82, vertikal: 0.95

Unterschrift des Schützen

Ergebnis: **315.0** (300)  
 Serien: 106.2 105.0 103.8  
 Zähler: 30 0 0 0 0 0 0 0 0 0  
 Innenzehner: 26  
 weiteste: 226 (20), 213 (27), 211 (28)  
 beste Teiler 1.0 (1.) 1.0 (7.) 39.0 (24.)  
 Trefferlage 0.08 mm rechts, 0.04 mm hoch  
 Streuwert 0.91, horizontal: 1.05, vertikal: 0.75

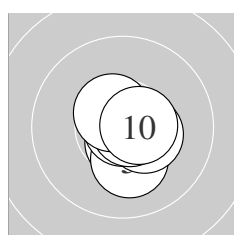
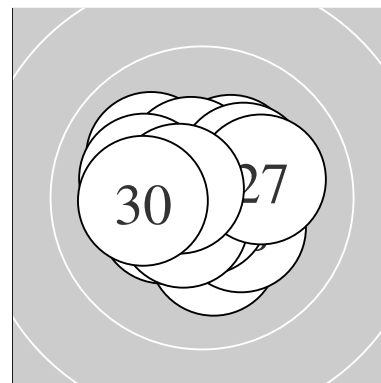

Serie 1:  
 10.9 \*                      10.6 \*                      10.8 \*                      10.5 \*                      10.2 \*  
 10.4 \*                      10.9 \*                      10.8 \*                      10.5 \*                      10.6 \*  
 beste Teiler 1.0 (1.) 1.0 (7.) 42.1 (8.)  
 Trefferlage 0.40 mm rechts, 0.28 mm tief  
 Streuwert 0.64, horizontal: 0.56, vertikal: 0.70

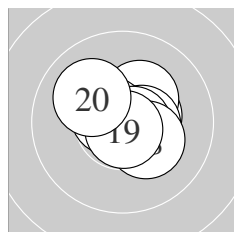

Serie 2:  
 10.6 \*                      10.5 \*                      10.3 \*                      10.6 \*                      10.7 \*  
 10.5 \*                      10.7 \*                      10.3 \*                      10.8 \*                      10.0 ↘  
 beste Teiler 42.5 (19.) 60.7 (17.) 63.1 (15.)  
 Trefferlage 0.31 mm rechts, 0.22 mm hoch  
 Streuwert 0.89, horizontal: 0.99, vertikal: 0.79

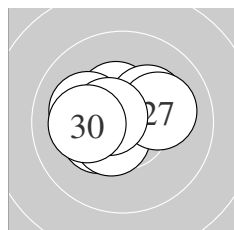

Serie 3:  
 10.7 \*                      10.4 \*                      10.3 \*                      10.8 \*                      10.5 \*  
 10.2 \*                      10.1 →                      10.1 ←                      10.6 \*                      10.1 ←  
 beste Teiler 39.0 (24.) 58.5 (21.) 86.1 (29.)  
 Trefferlage 0.46 mm links, 0.18 mm hoch  
 Streuwert 1.06, horizontal: 1.32, vertikal: 0.72

Unterschrift des Schützen

Ergebnis: **310.6** (296)  
 Serien: 105.1 104.0 101.5  
 Zähler: 26 4 0 0 0 0 0 0 0 0  
 Innenzehner: 23  
 weiteste: 292 (27), 291 (30), 276 (28)  
 beste Teiler 17.4 (5.) 58.1 (12.) 59.8 (2.)  
 Trefferlage 0.02 mm links, 0.47 mm hoch  
 Streuwert 1.16, horizontal: 1.25, vertikal: 1.05

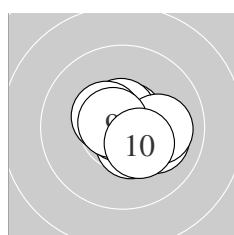
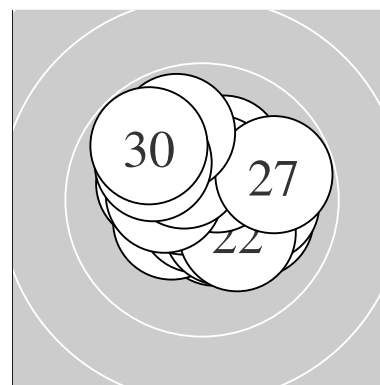

Serie 1:  
 10.7 \*                      10.7 \*                      10.5 \*                      10.1 ↗                      10.9 \*  
 10.6 \*                      10.5 \*                      10.0 →                      10.7 \*                      10.4 \*  
 beste Teiler 17.4 (5.) 59.8 (2.) 68.4 (9.)  
 Trefferlage 0.44 mm rechts, 0.01 mm hoch  
 Streuwert 0.92, horizontal: 1.07, vertikal: 0.72

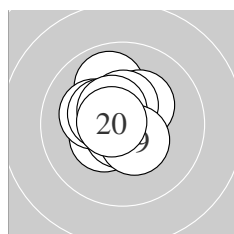

Serie 2:  
 10.4 \*                      10.7 \*                      9.9 ↖                      10.3 \*                      10.5 \*  
 10.2 \*                      10.4 \*                      10.5 \*                      10.4 \*                      10.7 \*  
 beste Teiler 58.1 (12.) 71.5 (20.) 111.2 (18.)  
 Trefferlage 0.48 mm links, 0.48 mm hoch  
 Streuwert 0.99, horizontal: 0.91, vertikal: 1.06

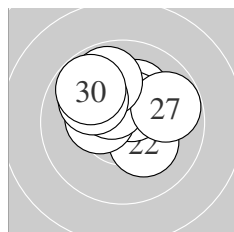

Serie 3:  
 10.4 \*                      10.2 \*                      10.2 \*                      10.5 \*                      10.4 \*  
 10.4 \*                      9.8 ↗                      9.8 ↖                      10.0 ↖                      9.8 ↖  
 beste Teiler 115.1 (24.) 134.1 (26.) 145.0 (21.)  
 Trefferlage 0.02 mm links, 0.92 mm hoch  
 Streuwert 1.42, horizontal: 1.61, vertikal: 1.20

Unterschrift des Schützen

Meyton Elektronik

Ergebnis: **309.5** (295)  
 Serien: 102.9 103.9 102.7  
 Zähler: 26 3 1 0 0 0 0 0 0 0  
 Innenzehner: 22  
 weiteste: 534 (29), 344 (24), 264 (20)  
 beste Teiler 18.0 (22.) 43.1 (26.) 44.7 (23.)  
 Trefferlage 0.10 mm links, 0.09 mm hoch  
 Streuwert 1.37, horizontal: 1.46, vertikal: 1.28

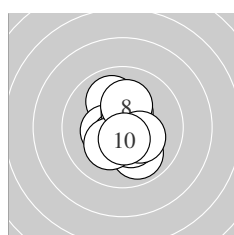
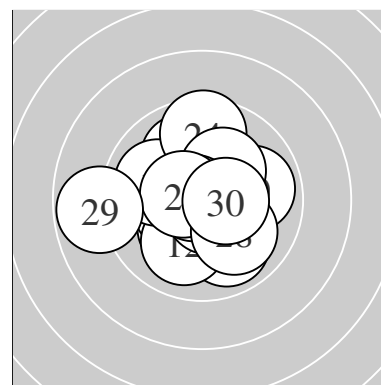

Serie 1:  
 9.9 ↘ 10.4 \* 10.0 ↗ 10.4 \* 10.6 \*  
 10.4 \* 10.2 \* 10.2 \* 10.3 \* 10.5 \*  
 beste Teiler 92.5 (5.) 102.9 (10.) 131.8 (6.)  
 Trefferlage 0.04 mm rechts, 0.26 mm tief  
 Streuwert 1.28, horizontal: 1.00, vertikal: 1.51

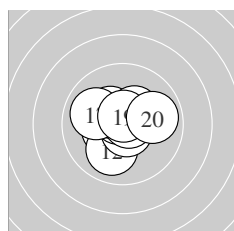

Serie 2:  
 10.4 \* 10.0 ↙ 10.7 \* 10.7 \* 10.4 \*  
 10.7 \* 10.0 ↖ 10.4 \* 10.7 \* 9.9 →  
 beste Teiler 56.3 (16.) 59.0 (14.) 67.7 (13.)  
 Trefferlage 0.13 mm links, 0.16 mm hoch  
 Streuwert 1.21, horizontal: 1.38, vertikal: 1.01

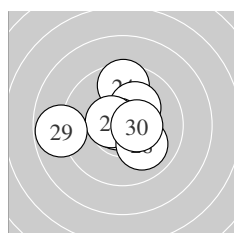

Serie 3:  
 10.6 \* 10.9 \* 10.8 \* 9.6 ↑ 10.2 \*  
 10.8 \* 10.5 \* 10.0 ↘ 8.8 ← 10.5 \*  
 beste Teiler 18.0 (22.) 43.1 (26.) 44.7 (23.)  
 Trefferlage 0.21 mm links, 0.38 mm hoch  
 Streuwert 1.69, horizontal: 1.99, vertikal: 1.33

Unterschrift des Schützen

Ergebnis: **308.6** (295)  
 Serien: 102.6 103.5 102.5  
 Zähler: 25 5 0 0 0 0 0 0 0 0  
 Innenzehner: 21  
 weiteste: 360 (13), 345 (7), 332 (20)  
 beste Teiler 25.4 (19.) 29.9 (15.) 64.6 (9.)  
 Trefferlage 0.17 mm links, 0.03 mm hoch  
 Streuwert 1.35, horizontal: 1.63, vertikal: 1.01

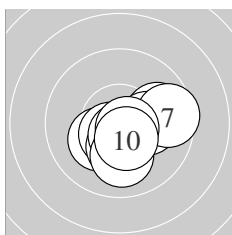
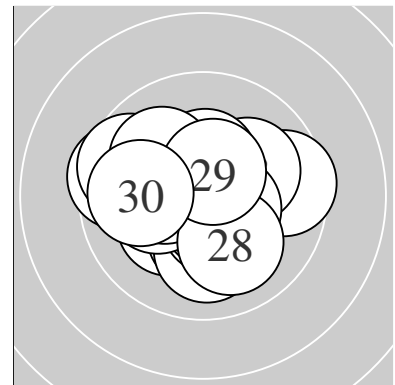

Serie 1:  
 9.9 → 10.2 \* 10.6 \* 10.3 \* 10.2 \*  
 10.6 \* 9.6 → 10.0 ↓ 10.7 \* 10.5 \*  
 beste Teiler 64.6 (9.) 84.0 (6.) 100.7 (3.)  
 Trefferlage 0.69 mm rechts, 0.69 mm tief  
 Streuwert 1.25, horizontal: 1.51, vertikal: 0.92

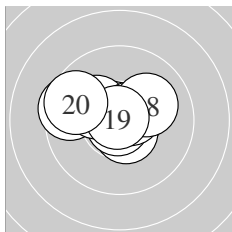

Serie 2:  
 10.5 \* 10.7 \* 9.5 ← 10.6 \* 10.8 \*  
 10.2 \* 10.6 \* 10.1 ↗ 10.9 \* 9.6 ↖  
 beste Teiler 25.4 (19.) 29.9 (15.) 71.4 (12.)  
 Trefferlage 0.50 mm links, 0.44 mm hoch  
 Streuwert 1.32, horizontal: 1.75, vertikal: 0.63

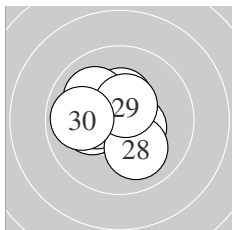

Serie 3:  
 10.2 \* 10.5 \* 10.4 \* 10.2 \* 10.5 \*  
 10.3 \* 10.0 ↖ 10.0 ↘ 10.5 \* 9.9 ←  
 beste Teiler 110.3 (29.) 119.4 (22.) 119.4 (25.)  
 Trefferlage 0.73 mm links, 0.34 mm hoch  
 Streuwert 1.22, horizontal: 1.37, vertikal: 1.06

Unterschrift des Schützen

Ergebnis: **307.5** (293)  
 Serien: 103.5 102.4 101.6  
 Zähler: 23 7 0 0 0 0 0 0 0 0  
 Innenzehner: 20  
 weiteste: 444 (26), 391 (7), 371 (16)  
 beste Teiler 2.2 (12.) 24.3 (15.) 27.6 (9.)  
 Trefferlage 0.58 mm rechts, 0.28 mm hoch  
 Streuwert 1.41, horizontal: 1.74, vertikal: 0.98

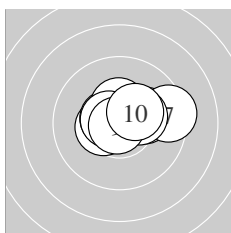
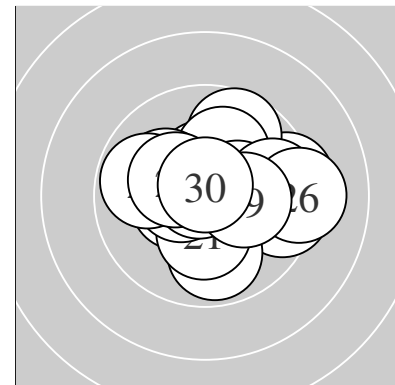

Serie 1:  
 10.4 \* 10.1 → 10.6 \* 10.4 \* 10.6 \*  
 10.5 \* 9.4 → 10.3 \* 10.8 \* 10.4 \*  
 beste Teiler 27.6 (9.) 89.8 (5.) 96.7 (3.)  
 Trefferlage 0.62 mm rechts, 0.48 mm hoch  
 Streuwert 1.17, horizontal: 1.59, vertikal: 0.48

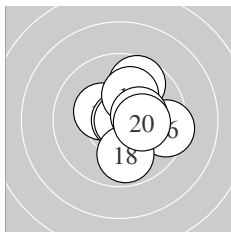

Serie 2:  
 10.3 \* 10.9 \* 9.7 ↗ 10.6 \* 10.9 \*  
 9.5 → 10.1 ↗ 9.9 ↓ 10.3 \* 10.2 \*  
 beste Teiler 2.2 (12.) 24.3 (15.) 85.4 (14.)  
 Trefferlage 0.92 mm rechts, 0.18 mm hoch  
 Streuwert 1.41, horizontal: 1.32, vertikal: 1.49

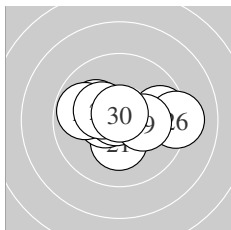

Serie 3:  
 10.3 \* 10.5 \* 10.1 ↖ 9.8 ↖ 9.7 →  
 9.2 → 10.8 \* 10.3 \* 10.2 \* 10.7 \*  
 beste Teiler 36.2 (27.) 52.0 (30.) 113.1 (22.)  
 Trefferlage 0.20 mm rechts, 0.18 mm hoch  
 Streuwert 1.70, horizontal: 2.29, vertikal: 0.76

Unterschrift des Schützen

Ergebnis: **310.7** (299)  
 Serien: 103.2 103.5 104.0  
 Zähler: 29 1 0 0 0 0 0 0 0 0  
 Innenzehner: 24  
 weiteste: 277 (14), 235 (24), 228 (6)  
 beste Teiler 13.4 (18.) 49.9 (19.) 68.2 (25.)  
 Trefferlage 0.00 mm , 0.34 mm hoch  
 Streuwert 1.14, horizontal: 1.26, vertikal: 1.01

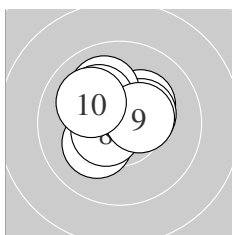
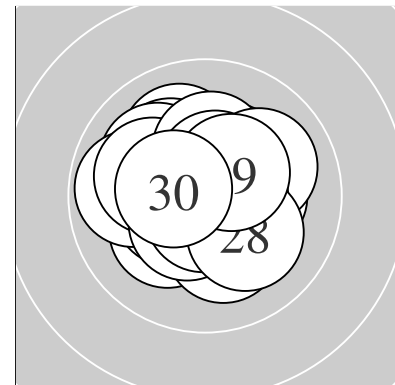

Serie 1:  
 10.7 \*                      10.2 \*                      10.4 \*                      10.2 \*                      10.4 \*  
 10.0 ↘                      10.2 \*                      10.6 \*                      10.4 \*                      10.1 ↖  
 beste Teiler 69.6 (1.) 100.8 (8.) 130.7 (9.)  
 Trefferlage 0.35 mm links, 0.62 mm hoch  
 Streuwert 1.14, horizontal: 1.22, vertikal: 1.04

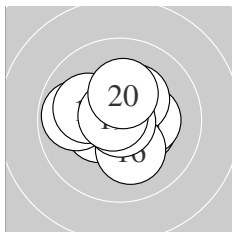

Serie 2:  
 10.4 \*                      10.4 \*                      10.3 \*                      9.8 ←                      10.3 \*  
 10.2 \*                      10.1 ↖                      10.9 \*                      10.8 \*                      10.3 \*  
 beste Teiler 13.4 (18.) 49.9 (19.) 136.3 (11.)  
 Trefferlage 0.15 mm links, 0.14 mm hoch  
 Streuwert 1.26, horizontal: 1.47, vertikal: 1.01

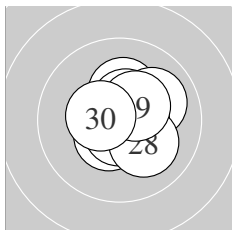

Serie 3:  
 10.2 \*                      10.5 \*                      10.5 \*                      10.0 ↗                      10.7 \*  
 10.6 \*                      10.5 \*                      10.1 ↘                      10.4 \*                      10.5 \*  
 beste Teiler 68.2 (25.) 94.0 (26.) 110.1 (27.)  
 Trefferlage 0.50 mm rechts, 0.28 mm hoch  
 Streuwert 1.01, horizontal: 0.99, vertikal: 1.03

Unterschrift des Schützen



Ergebnis: **308.9** (294)  
 Serien: 102.2 102.5 104.2  
 Zähler: 24 6 0 0 0 0 0 0 0 0  
 Innenzehner: 21  
 weiteste: 422 (4), 388 (8), 348 (19)  
 beste Teiler 34.7 (9.) 38.8 (28.) 53.0 (21.)  
 Trefferlage 0.39 mm links, 0.35 mm hoch  
 Streuwert 1.34, horizontal: 1.62, vertikal: 0.97

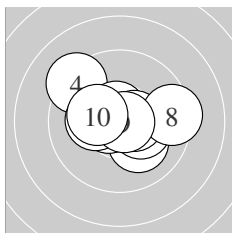
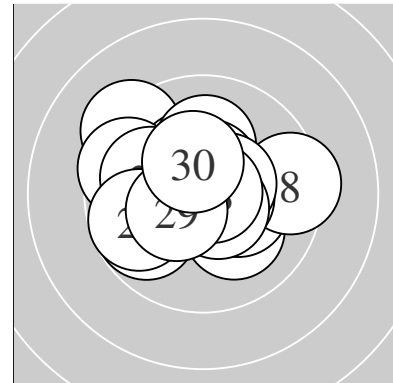

Serie 1:  
 10.1 ↘ 10.6 \* 10.3 \* 9.3 ↘ 10.2 \*  
 10.7 \* 10.5 \* 9.4 → 10.8 \* 10.3 \*  
 beste Teiler 34.7 (9.) 74.3 (6.) 80.8 (2.)  
 Trefferlage 0.05 mm rechts, 0.22 mm hoch  
 Streuwert 1.63, horizontal: 2.03, vertikal: 1.10

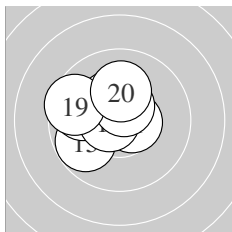

Serie 2:  
 10.6 \* 10.3 \* 10.5 \* 10.7 \* 9.8 ↙  
 9.8 ← 10.6 \* 10.5 \* 9.6 ↖ 10.1 ↑  
 beste Teiler 69.0 (14.) 76.4 (17.) 92.3 (11.)  
 Trefferlage 0.88 mm links, 0.62 mm hoch  
 Streuwert 1.25, horizontal: 1.45, vertikal: 1.02

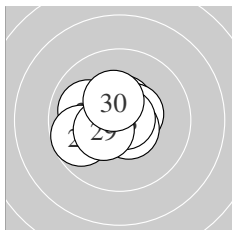

Serie 3:  
 10.7 \* 10.5 \* 10.0 ↖ 10.6 \* 10.5 \*  
 9.7 ↙ 10.6 \* 10.8 \* 10.4 \* 10.4 \*  
 beste Teiler 38.8 (28.) 53.0 (21.) 91.9 (27.)  
 Trefferlage 0.36 mm links, 0.22 mm hoch  
 Streuwert 1.10, horizontal: 1.33, vertikal: 0.82

Unterschrift des Schützen

Ergebnis: **308.0** (291)  
 Serien: 102.2 102.2 103.6  
 Zähler: 22 7 1 0 0 0 0 0 0 0  
 Innenzehner: 21  
 weiteste: 614 (30), 402 (20), 374 (9)  
 beste Teiler 4.1 (29.) 8.6 (27.) 41.0 (23.)  
 Trefferlage 0.07 mm rechts, 0.48 mm hoch  
 Streuwert 1.55, horizontal: 2.01, vertikal: 0.88

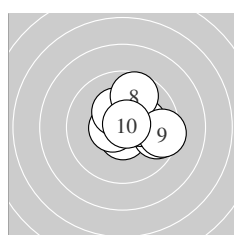
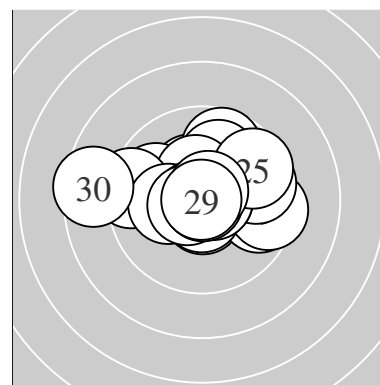

Serie 1:  
 10.6 \*                      9.6 →                      10.6 \*                      10.4 \*                      10.5 \*  
 10.2 \*                      10.3 \*                      9.7 ↑                      9.5 →                      10.8 \*  
 beste Teiler 47.0 (10.) 80.0 (1.) 93.3 (3.)  
 Trefferlage 1.06 mm rechts, 0.43 mm hoch  
 Streuwert 1.33, horizontal: 1.51, vertikal: 1.13

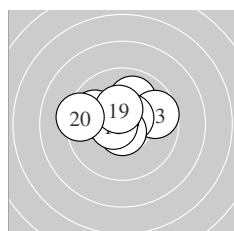

Serie 2:  
 10.4 \*                      10.0 ↑                      9.7 →                      10.6 \*                      9.9 ↖  
 10.7 \*                      10.6 \*                      10.6 \*                      10.4 \*                      9.3 ←  
 beste Teiler 69.0 (16.) 85.5 (18.) 89.2 (14.)  
 Trefferlage 0.36 mm links, 0.78 mm hoch  
 Streuwert 1.47, horizontal: 1.91, vertikal: 0.81

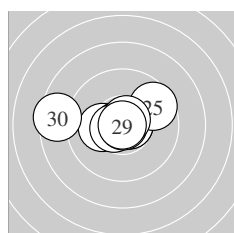

Serie 3:  
 10.2 \*                      10.7 \*                      10.8 \*                      10.7 \*                      9.6 ↗  
 10.6 \*                      10.9 \*                      10.7 \*                      10.9 \*                      8.5 ←  
 beste Teiler 4.1 (29.) 8.6 (27.) 41.0 (23.)  
 Trefferlage 0.48 mm links, 0.24 mm hoch  
 Streuwert 1.70, horizontal: 2.32, vertikal: 0.62

Unterschrift des Schützen

Meyton Elektronik

Ergebnis: **306.5** (294)  
 Serien: 101.7 102.9 101.9  
 Zähler: 24 6 0 0 0 0 0 0 0 0  
 Innenzehner: 16  
 weiteste: 424 (3), 335 (23), 332 (9)  
 beste Teiler 40.6 (6.) 44.9 (4.) 45.8 (16.)  
 Trefferlage 0.19 mm links, 0.61 mm hoch  
 Streuwert 1.40, horizontal: 1.57, vertikal: 1.22

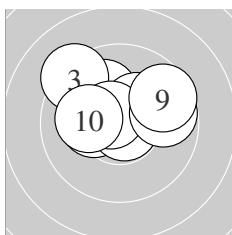
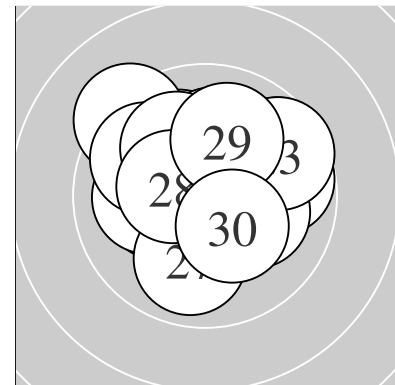

Serie 1:  
 10.1 ↖ 10.3 \* 9.3 ↘ 10.8 \* 10.3 \*  
 10.8 \* 10.6 \* 9.8 → 9.6 ↗ 10.1 ←  
 beste Teiler 40.6 (6.) 44.9 (4.) 79.2 (7.)  
 Trefferlage 0.06 mm links, 0.89 mm hoch  
 Streuwert 1.59, horizontal: 1.99, vertikal: 1.05

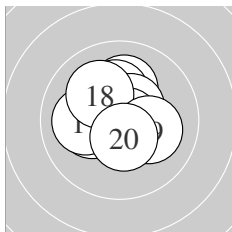

Serie 2:  
 10.1 ↑ 10.2 \* 10.2 \* 10.3 \* 10.5 \*  
 10.8 \* 10.1 ← 10.1 ↘ 10.1 → 10.5 \*  
 beste Teiler 45.8 (16.) 111.2 (15.) 116.4 (20.)  
 Trefferlage 0.32 mm links, 0.50 mm hoch  
 Streuwert 1.21, horizontal: 1.30, vertikal: 1.11

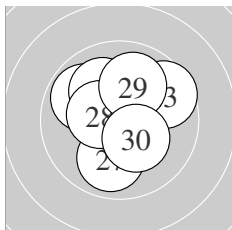

Serie 3:  
 10.4 \* 10.7 \* 9.6 ↗ 9.8 ↘ 10.7 \*  
 10.1 ↘ 9.9 ↓ 10.4 \* 10.0 ↑ 10.3 \*  
 beste Teiler 65.1 (25.) 73.0 (22.) 133.2 (28.)  
 Trefferlage 0.18 mm links, 0.44 mm hoch  
 Streuwert 1.51, horizontal: 1.49, vertikal: 1.53

Unterschrift des Schützen

Ergebnis: **303.3** (289)  
 Serien: 100.0 100.8 102.5  
 Zähler: 19 11 0 0 0 0 0 0 0 0  
 Innenzehner: 13  
 weiteste: 426 (7), 417 (20), 395 (6)  
 beste Teiler 57.0 (26.) 58.2 (2.) 62.5 (22.)  
 Trefferlage 0.57 mm links, 0.65 mm hoch  
 Streuwert 1.61, horizontal: 1.92, vertikal: 1.21

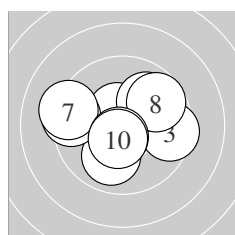
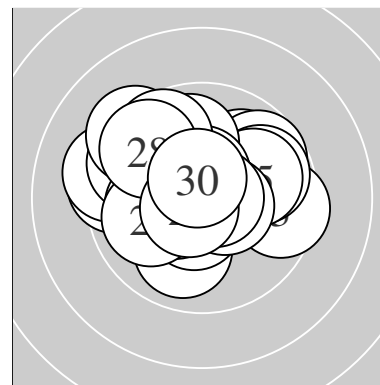

Serie 1:  
 10.0 ↘                      10.7 \*                      9.5 →                      10.5 \*                      9.9 ↗  
 9.4 ←                      9.2 ←                      9.7 ↗                      10.6 \*                      10.5 \*  
 beste Teiler 58.2 (2.) 92.6 (9.) 106.2 (4.)  
 Trefferlage 0.15 mm links, 0.19 mm hoch  
 Streuwert 2.00, horizontal: 2.49, vertikal: 1.34

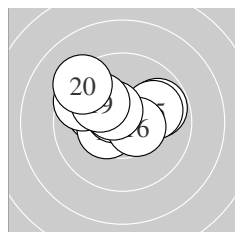

Serie 2:  
 10.1 ↖                      9.8 →                      10.4 \*                      10.6 \*                      10.0 →  
 10.5 \*                      9.6 ↖                      10.5 \*                      10.0 ↖                      9.3 ↖  
 beste Teiler 89.2 (14.) 109.7 (16.) 113.8 (18.)  
 Trefferlage 0.62 mm links, 0.94 mm hoch  
 Streuwert 1.59, horizontal: 2.03, vertikal: 0.96

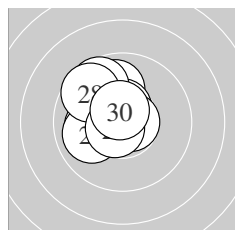

Serie 3:  
 9.9 ↑                      10.7 \*                      10.5 \*                      10.1 ←                      9.7 ↖  
 10.7 \*                      10.0 ←                      9.6 ↖                      10.7 \*                      10.6 \*  
 beste Teiler 57.0 (26.) 62.5 (22.) 73.4 (29.)  
 Trefferlage 0.93 mm links, 0.83 mm hoch  
 Streuwert 1.21, horizontal: 1.13, vertikal: 1.28

Unterschrift des Schützen

Ergebnis: **311.4** (299)  
 Serien: 104.3 102.8 104.3  
 Zähler: 29 1 0 0 0 0 0 0 0 0  
 Innenzehner: 23  
 weiteste: 294 (16), 229 (24), 215 (1)  
 beste Teiler 15.2 (2.) 61.0 (7.) 66.6 (27.)  
 Trefferlage 0.01 mm links, 0.41 mm hoch  
 Streuwert 1.08, horizontal: 1.08, vertikal: 1.08

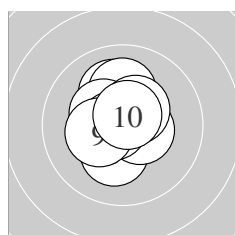
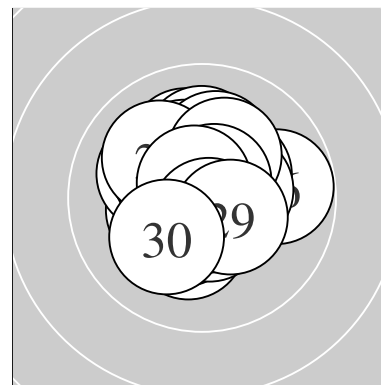

Serie 1:  
 10.1 ↗ 10.9 \* 10.1 ↑ 10.4 \* 10.2 \*  
 10.5 \* 10.7 \* 10.4 \* 10.3 \* 10.7 \*  
 beste Teiler 15.2 (2.) 61.0 (7.) 73.8 (10.)  
 Trefferlage 0.22 mm links, 0.42 mm hoch  
 Streuwert 1.03, horizontal: 0.85, vertikal: 1.17

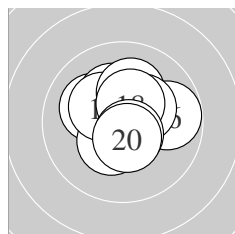

Serie 2:  
 10.1 ↘ 10.3 \* 10.4 \* 10.3 \* 10.1 ↗  
 9.8 → 10.3 \* 10.4 \* 10.6 \* 10.5 \*  
 beste Teiler 88.5 (19.) 107.0 (20.) 132.2 (18.)  
 Trefferlage 0.13 mm rechts, 0.50 mm hoch  
 Streuwert 1.25, horizontal: 1.37, vertikal: 1.12

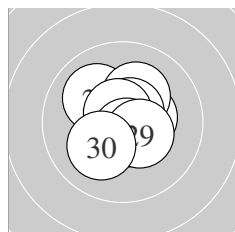

Serie 3:  
 10.5 \* 10.4 \* 10.7 \* 10.0 ↘ 10.2 \*  
 10.6 \* 10.7 \* 10.7 \* 10.4 \* 10.1 ↗  
 beste Teiler 66.6 (27.) 70.6 (23.) 72.8 (28.)  
 Trefferlage 0.06 mm rechts, 0.32 mm hoch  
 Streuwert 1.03, horizontal: 1.03, vertikal: 1.03

Unterschrift des Schützen

Ergebnis: **310.5** (297)  
 Serien: 101.7 104.5 104.3  
 Zähler: 27 3 0 0 0 0 0 0 0 0  
 Innenzehner: 24  
 weiteste: 362 (5), 320 (13), 254 (4)  
 beste Teiler 26.9 (20.) 46.8 (28.) 50.4 (19.)  
 Trefferlage 0.11 mm links, 0.18 mm tief  
 Streuwert 1.20, horizontal: 1.23, vertikal: 1.16

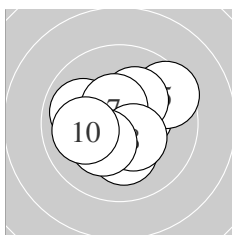
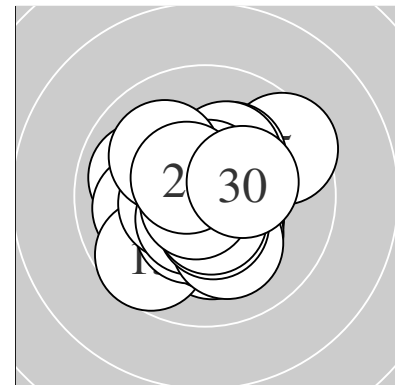

Serie 1:  
 10.4 \*                      10.3 \*                      10.2 \*                      9.9 ↖                      9.5 ↗  
 10.2 \*                      10.5 \*                      10.4 \*                      10.3 \*                      10.0 ←  
 beste Teiler 111.9 (7.) 132.2 (8.) 138.8 (1.)  
 Trefferlage 0.10 mm links, 0.15 mm hoch  
 Streuwert 1.53, horizontal: 1.76, vertikal: 1.26

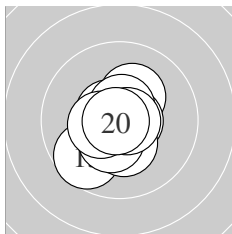

Serie 2:  
 10.2 \*                      10.7 \*                      9.7 ↙                      10.6 \*                      10.3 \*  
 10.4 \*                      10.6 \*                      10.4 \*                      10.8 \*                      10.8 \*  
 beste Teiler 26.9 (20.) 50.4 (19.) 67.1 (12.)  
 Trefferlage 0.25 mm links, 0.28 mm tief  
 Streuwert 1.06, horizontal: 0.94, vertikal: 1.16

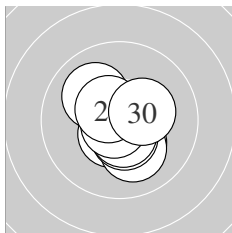

Serie 3:  
 10.0 ↘                      10.7 \*                      10.3 \*                      10.5 \*                      10.1 ↘  
 10.5 \*                      10.6 \*                      10.8 \*                      10.5 \*                      10.3 \*  
 beste Teiler 46.8 (28.) 57.8 (22.) 94.3 (27.)  
 Trefferlage 0.01 mm rechts, 0.40 mm tief  
 Streuwert 1.02, horizontal: 0.93, vertikal: 1.09

Unterschrift des Schützen

Ergebnis: **311.5** (299)  
 Serien: 103.9 102.9 104.7  
 Zähler: 29 1 0 0 0 0 0 0 0 0  
 Innenzehner: 24  
 weiteste: 267 (19), 241 (10), 239 (4)  
 beste Teiler 22.0 (26.) 47.8 (13.) 62.7 (3.)  
 Trefferlage 0.01 mm links, 0.10 mm hoch  
 Streuwert 1.11, horizontal: 1.10, vertikal: 1.12

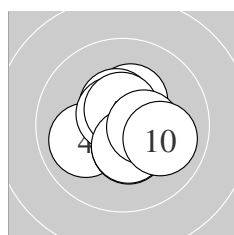
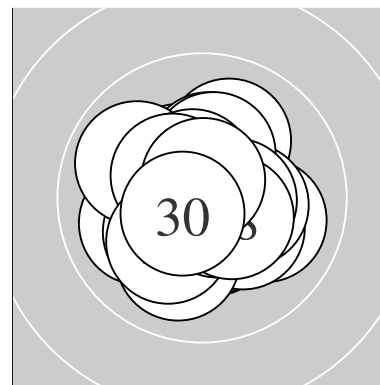

Serie 1:  
 10.3 \*                      10.5 \*                      10.7 \*                      10.0 ↙                      10.4 \*  
 10.6 \*                      10.6 \*                      10.4 \*                      10.4 \*                      10.0 →  
 beste Teiler 62.7 (3.) 88.7 (6.) 95.3 (7.)  
 Trefferlage 0.12 mm rechts, 0.04 mm hoch  
 Streuwert 1.12, horizontal: 1.18, vertikal: 1.05

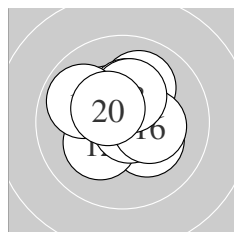

Serie 2:  
 10.2 \*                      10.2 \*                      10.8 \*                      10.4 \*                      10.0 ↗  
 10.3 \*                      10.3 \*                      10.3 \*                      9.9 ↖                      10.5 \*  
 beste Teiler 47.8 (13.) 121.6 (20.) 143.2 (14.)  
 Trefferlage 0.02 mm links, 0.57 mm hoch  
 Streuwert 1.24, horizontal: 1.29, vertikal: 1.18

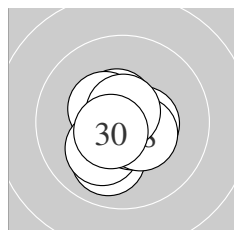

Serie 3:  
 10.5 \*                      10.0 ↘                      10.4 \*                      10.1 ↙                      10.6 \*  
 10.9 \*                      10.5 \*                      10.4 \*                      10.7 \*                      10.6 \*  
 beste Teiler 22.0 (26.) 65.1 (29.) 85.7 (25.)  
 Trefferlage 0.13 mm links, 0.31 mm tief  
 Streuwert 0.96, horizontal: 0.87, vertikal: 1.04

Unterschrift des Schützen

Ergebnis: **306.7** (294)  
 Serien: 102.8 101.3 102.6  
 Zähler: 24 6 0 0 0 0 0 0 0 0  
 Innenzehner: 19  
 weiteste: 371 (18), 331 (28), 299 (16)  
 beste Teiler 67.6 (17.) 69.7 (5.) 70.6 (12.)  
 Trefferlage 0.35 mm links, 0.05 mm hoch  
 Streuwert 1.43, horizontal: 1.29, vertikal: 1.55

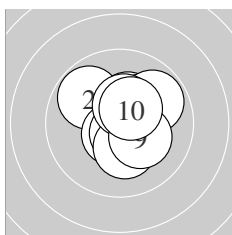
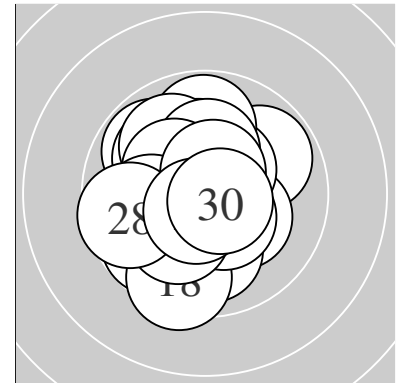

Serie 1:  
 10.4 \*                      9.8 ↘                      10.6 \*                      10.2 \*                      10.7 \*  
 9.8 ↗                      10.3 \*                      10.4 \*                      10.2 \*                      10.4 \*  
 beste Teiler 69.7 (5.) 89.6 (3.) 128.7 (8.)  
 Trefferlage 0.48 mm rechts, 0.41 mm hoch  
 Streuwert 1.26, horizontal: 1.23, vertikal: 1.29

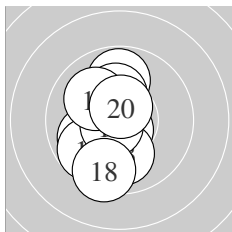

Serie 2:  
 10.0 ↙                      10.7 \*                      10.0 ↓                      9.8 ↑                      10.2 \*  
 9.8 ↙                      10.7 \*                      9.5 ↓                      10.0 ↘                      10.6 \*  
 beste Teiler 67.6 (17.) 70.6 (12.) 95.4 (20.)  
 Trefferlage 0.76 mm links, 0.31 mm tief  
 Streuwert 1.60, horizontal: 0.96, vertikal: 2.05

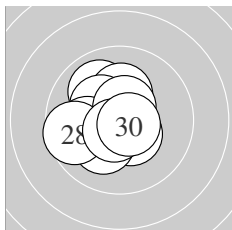

Serie 3:  
 10.0 ↘                      10.2 \*                      10.4 \*                      10.3 \*                      10.0 ←  
 10.2 \*                      10.6 \*                      9.6 ←                      10.6 \*                      10.7 \*  
 beste Teiler 71.1 (30.) 82.2 (29.) 97.1 (27.)  
 Trefferlage 0.78 mm links, 0.05 mm hoch  
 Streuwert 1.29, horizontal: 1.31, vertikal: 1.26

Unterschrift des Schützen



Ergebnis: **306.9** (293)  
 Serien: 102.1 103.5 101.3  
 Zähler: 23 7 0 0 0 0 0 0 0 0  
 Innenzehner: 18  
 weiteste: 481 (8), 386 (29), 359 (24)  
 beste Teiler 22.1 (4.) 36.7 (2.) 49.0 (26.)  
 Trefferlage 0.10 mm links, 0.56 mm tief  
 Streuwert 1.46, horizontal: 1.63, vertikal: 1.27

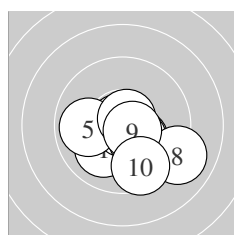
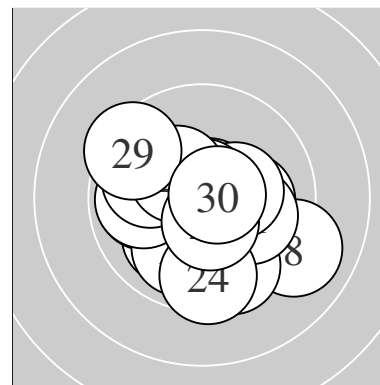

Serie 1:  
 10.0 ↙ 10.8 \* 10.3 \* 10.9 \* 9.9 ←  
 10.7 \* 10.3 \* 9.0 ↘ 10.6 \* 9.6 ↓  
 beste Teiler 22.1 (4.) 36.7 (2.) 59.6 (6.)  
 Trefferlage 0.46 mm rechts, 0.94 mm tief  
 Streuwert 1.53, horizontal: 1.83, vertikal: 1.16

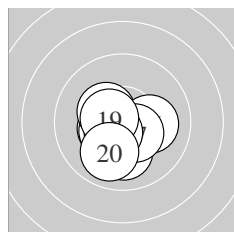

Serie 2:  
 10.1 ↓ 10.4 \* 10.4 \* 10.4 \* 10.6 \*  
 10.1 → 10.5 \* 10.5 \* 10.5 \* 10.0 ↙  
 beste Teiler 87.2 (15.) 106.2 (18.) 106.3 (19.)  
 Trefferlage 0.35 mm links, 0.71 mm tief  
 Streuwert 1.04, horizontal: 1.10, vertikal: 0.97

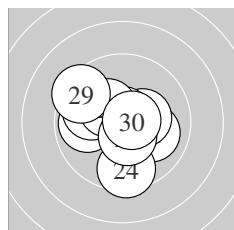

Serie 3:  
 10.0 ↘ 9.9 ← 10.3 \* 9.5 ↓ 9.9 ↖  
 10.8 \* 10.3 \* 10.5 \* 9.4 ↗ 10.7 \*  
 beste Teiler 49.0 (26.) 71.3 (30.) 116.3 (28.)  
 Trefferlage 0.43 mm links, 0.05 mm tief  
 Streuwert 1.70, horizontal: 1.84, vertikal: 1.55

Unterschrift des Schützen

Ergebnis: **305.7** (292)  
 Serien: 102.8 100.3 102.6  
 Zähler: 23 6 1 0 0 0 0 0 0 0  
 Innenzehner: 18  
 weiteste: 501 (18), 359 (27), 337 (16)  
 beste Teiler 12.1 (28.) 36.1 (20.) 53.5 (17.)  
 Trefferlage 0.01 mm links, 0.01 mm tief  
 Streuwert 1.56, horizontal: 1.79, vertikal: 1.29

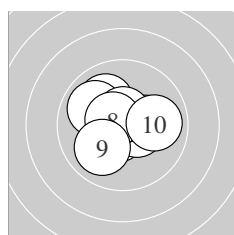
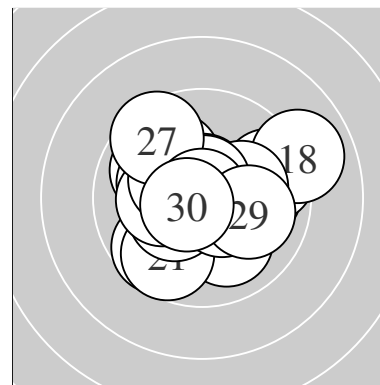

Serie 1:  
 10.5 \*                      10.6 \*                      10.0 ↘                      9.9 ↖                      10.2 \*  
 10.5 \*                      10.6 \*                      10.6 \*                      10.0 ✓                      9.9 →  
 beste Teiler 81.8 (2.) 84.1 (7.) 88.5 (8.)  
 Trefferlage 0.16 mm links, 0.11 mm hoch  
 Streuwert 1.33, horizontal: 1.55, vertikal: 1.08

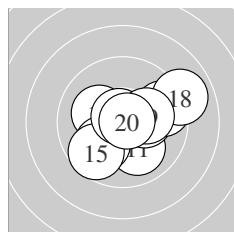

Serie 2:  
 10.0 ↘                      10.2 \*                      10.0 ✓                      10.2 \*                      9.7 ✓  
 9.6 →                      10.7 \*                      8.9 →                      10.2 \*                      10.8 \*  
 beste Teiler 36.1 (20.) 53.5 (17.) 176.9 (14.)  
 Trefferlage 0.70 mm rechts, 0.11 mm tief  
 Streuwert 1.89, horizontal: 2.24, vertikal: 1.45

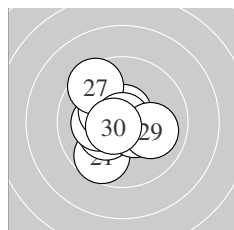

Serie 3:  
 9.7 ✓                      10.3 \*                      10.5 \*                      10.2 \*                      10.3 \*  
 10.6 \*                      9.5 ↘                      10.9 \*                      10.0 →                      10.6 \*  
 beste Teiler 12.1 (28.) 77.4 (26.) 80.1 (30.)  
 Trefferlage 0.58 mm links, 0.05 mm tief  
 Streuwert 1.41, horizontal: 1.40, vertikal: 1.43

Unterschrift des Schützen

Meyton Elektronik

Ergebnis: **306.7** (295)  
 Serien: 101.0 102.7 103.0  
 Zähler: 25 5 0 0 0 0 0 0 0 0  
 Innenzehner: 17  
 weiteste: 326 (2), 315 (26), 262 (4)  
 beste Teiler 51.6 (23.) 61.2 (19.) 85.5 (5.)  
 Trefferlage 0.17 mm rechts, 0.15 mm hoch  
 Streuwert 1.38, horizontal: 1.42, vertikal: 1.34

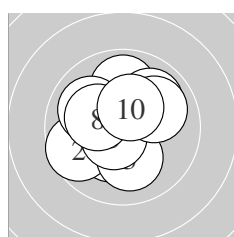
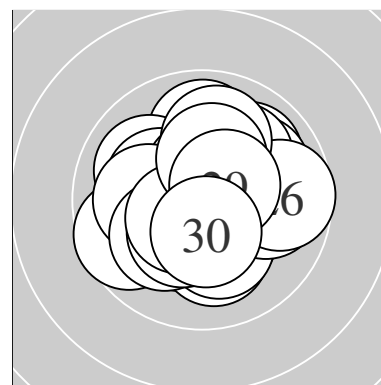

Serie 1:  
 10.3 \*                      9.6 ↙                      10.1 ↓                      9.9 ↑                      10.6 \*  
 9.9 ↗                      10.0 ↖                      10.2 \*                      10.0 ↘                      10.4 \*  
 beste Teiler 85.5 (5.) 143.1 (10.) 165.1 (1.)  
 Trefferlage 0.31 mm links, 0.32 mm hoch  
 Streuwert 1.61, horizontal: 1.65, vertikal: 1.58

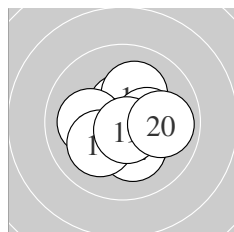

Serie 2:  
 10.3 \*                      10.2 \*                      10.5 \*                      10.1 ↗                      10.5 \*  
 10.3 \*                      10.1 ←                      10.1 ↙                      10.7 \*                      9.9 →  
 beste Teiler 61.2 (19.) 101.3 (13.) 101.5 (15.)  
 Trefferlage 0.23 mm rechts, 0.29 mm tief  
 Streuwert 1.29, horizontal: 1.43, vertikal: 1.13

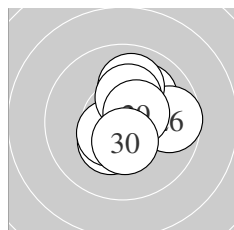

Serie 3:  
 10.3 \*                      10.5 \*                      10.7 \*                      10.5 \*                      10.1 ↗  
 9.7 →                      10.0 ↑                      10.3 \*                      10.5 \*                      10.4 \*  
 beste Teiler 51.6 (23.) 109.8 (29.) 113.4 (24.)  
 Trefferlage 0.61 mm rechts, 0.44 mm hoch  
 Streuwert 1.21, horizontal: 1.14, vertikal: 1.28

Unterschrift des Schützen

Ergebnis: **307.6** (292)  
 Serien: 100.7 103.5 103.4  
 Zähler: 22 8 0 0 0 0 0 0 0 0  
 Innenzehner: 18  
 weiteste: 414 (4), 382 (5), 382 (24)  
 beste Teiler 11.1 (27.) 36.0 (17.) 45.0 (30.)  
 Trefferlage 0.14 mm rechts, 0.48 mm hoch  
 Streuwert 1.45, horizontal: 1.63, vertikal: 1.24

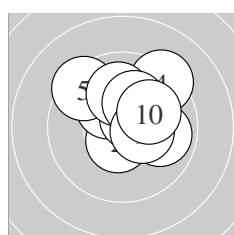
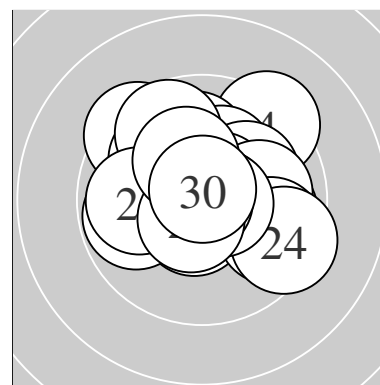

Serie 1:  
 9.9 → 10.6 \* 10.2 \* 9.3 ↗ 9.4 ↘  
 10.6 \* 10.0 ↑ 10.2 \* 10.4 \* 10.1 ↗  
 beste Teiler 89.8 (6.) 99.6 (2.) 139.8 (9.)  
 Trefferlage 0.55 mm rechts, 1.12 mm hoch  
 Streuwert 1.55, horizontal: 1.69, vertikal: 1.40

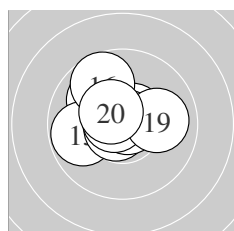

Serie 2:  
 10.0 ↘ 10.6 \* 9.8 ← 10.7 \* 10.7 \*  
 9.7 ↘ 10.8 \* 10.7 \* 10.0 → 10.5 \*  
 beste Teiler 36.0 (17.) 56.6 (14.) 57.2 (15.)  
 Trefferlage 0.46 mm links, 0.60 mm hoch  
 Streuwert 1.22, horizontal: 1.41, vertikal: 1.00

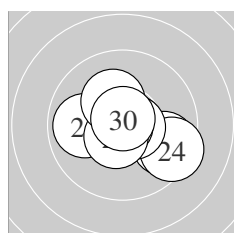

Serie 3:  
 10.6 \* 10.7 \* 9.7 ↘ 9.4 ↘ 10.6 \*  
 9.9 ← 10.9 \* 10.6 \* 10.2 \* 10.8 \*  
 beste Teiler 11.1 (27.) 45.0 (30.) 62.3 (22.)  
 Trefferlage 0.34 mm rechts, 0.26 mm tief  
 Streuwert 1.41, horizontal: 1.75, vertikal: 0.94

Unterschrift des Schützen

Ergebnis: **307.8** (294)  
 Serien: 103.9 99.5 104.4  
 Zähler: 24 6 0 0 0 0 0 0 0 0  
 Innenzehner: 21  
 weiteste: 385 (20), 382 (13), 337 (9)  
 beste Teiler 41.0 (6.) 48.0 (2.) 52.6 (7.)  
 Trefferlage 0.28 mm rechts, 0.09 mm hoch  
 Streuwert 1.41, horizontal: 1.31, vertikal: 1.50

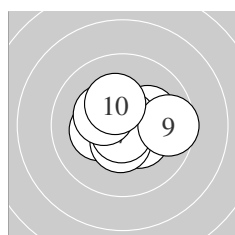
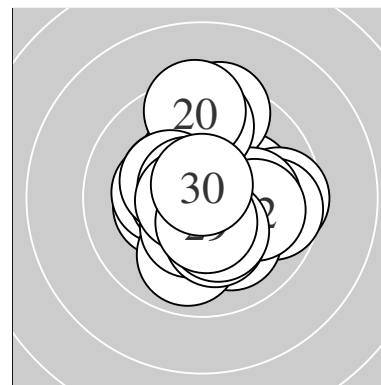

Serie 1:  
 10.4 \*                      10.8 \*                      10.3 \*                      10.2 \*                      10.5 \*  
 10.8 \*                      10.7 \*                      10.3 \*                      9.6 →                      10.3 \*  
 beste Teiler 41.0 (6.) 48.0 (2.) 52.6 (7.)  
 Trefferlage 0.33 mm rechts, 0.01 mm hoch  
 Streuwert 1.22, horizontal: 1.51, vertikal: 0.84

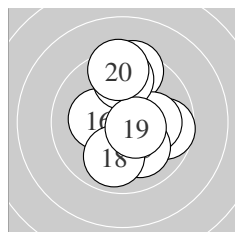

Serie 2:  
 10.5 \*                      9.7 →                      9.4 ↑                      10.1 →                      10.1 ↘  
 10.2 \*                      9.7 ↑                      9.9 ↓                      10.5 \*                      9.4 ↑  
 beste Teiler 104.0 (19.) 111.1 (11.) 176.5 (16.)  
 Trefferlage 0.54 mm rechts, 0.68 mm hoch  
 Streuwert 1.87, horizontal: 1.40, vertikal: 2.25

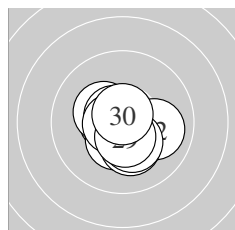

Serie 3:  
 10.6 \*                      10.0 →                      10.3 \*                      10.7 \*                      10.4 \*  
 10.2 \*                      10.7 \*                      10.3 \*                      10.5 \*                      10.7 \*  
 beste Teiler 58.0 (30.) 72.0 (27.) 75.8 (24.)  
 Trefferlage 0.03 mm links, 0.43 mm tief  
 Streuwert 0.98, horizontal: 1.06, vertikal: 0.90

Unterschrift des Schützen

Ergebnis: **305.0** (293)  
 Serien: 102.0 102.4 100.6  
 Zähler: 23 7 0 0 0 0 0 0 0 0  
 Innenzehner: 18  
 weiteste: 429 (24), 368 (14), 330 (1)  
 beste Teiler 63.5 (27.) 89.0 (28.) 89.2 (18.)  
 Trefferlage 0.20 mm rechts, 0.14 mm tief  
 Streuwert 1.55, horizontal: 1.79, vertikal: 1.26

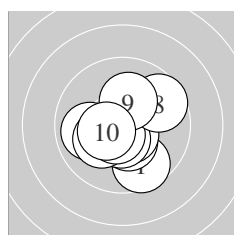
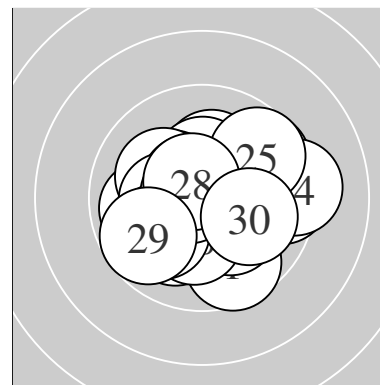

Serie 1:  
 9.6 ↘                      10.4 \*                      10.6 \*                      10.5 \*                      9.9 ←  
 10.2 \*                      10.6 \*                      9.6 ↗                      10.2 \*                      10.4 \*  
 beste Teiler 89.8 (3.) 90.1 (7.) 107.3 (4.)  
 Trefferlage 0.03 mm links, 0.52 mm tief  
 Streuwert 1.48, horizontal: 1.54, vertikal: 1.41

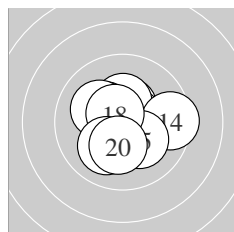

Serie 2:  
 10.5 \*                      10.6 \*                      10.3 \*                      9.5 →                      10.2 \*  
 10.3 \*                      10.1 ↖                      10.6 \*                      10.1 ↙                      10.2 \*  
 beste Teiler 89.2 (18.) 92.4 (12.) 125.5 (11.)  
 Trefferlage 0.09 mm rechts, 0.07 mm hoch  
 Streuwert 1.44, horizontal: 1.61, vertikal: 1.26

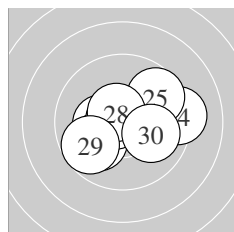

Serie 3:  
 10.3 \*                      10.0 →                      10.4 \*                      9.2 →                      9.7 ↗  
 10.0 ↙                      10.7 \*                      10.6 \*                      9.7 ↙                      10.0 ↘  
 beste Teiler 63.5 (27.) 89.0 (28.) 148.0 (23.)  
 Trefferlage 0.55 mm rechts, 0.01 mm hoch  
 Streuwert 1.79, horizontal: 2.27, vertikal: 1.13

Unterschrift des Schützen

Ergebnis: **310.0** (294)  
 Serien: 102.1 103.0 104.9  
 Zähler: 24 6 0 0 0 0 0 0 0 0  
 Innenzehner: 19  
 weiteste: 347 (4), 289 (11), 284 (8)  
 beste Teiler 44.9 (29.) 53.3 (2.) 55.1 (13.)  
 Trefferlage 0.24 mm links, 0.19 mm tief  
 Streuwert 1.24, horizontal: 1.27, vertikal: 1.21

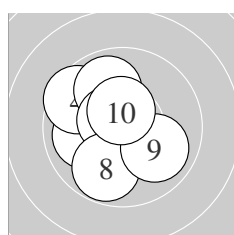
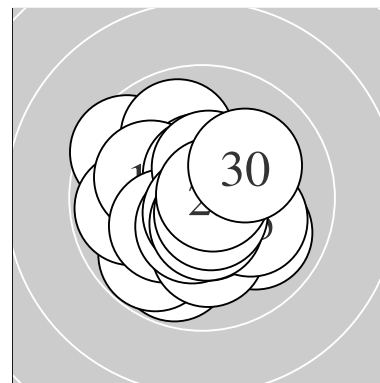

Serie 1:  
 10.5 \*                      10.7 \*                      10.0 ←                      9.6 ↖                      10.6 \*  
 9.9 ↗                      10.6 \*                      9.8 ↓                      9.9 ↘                      10.5 \*  
 beste Teiler 53.3 (2.) 76.8 (5.) 90.2 (7.)  
 Trefferlage 0.69 mm links, 0.20 mm hoch  
 Streuwert 1.46, horizontal: 1.38, vertikal: 1.53

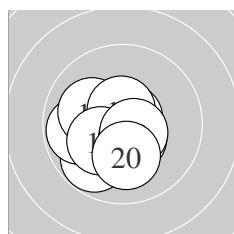

Serie 2:  
 9.8 ↙                      9.8 ←                      10.7 \*                      10.1 ↖                      10.6 \*  
 10.6 \*                      10.2 \*                      10.5 \*                      10.6 \*                      10.1 ↓  
 beste Teiler 55.1 (13.) 80.6 (15.) 92.0 (19.)  
 Trefferlage 0.58 mm links, 0.59 mm tief  
 Streuwert 1.19, horizontal: 1.30, vertikal: 1.08

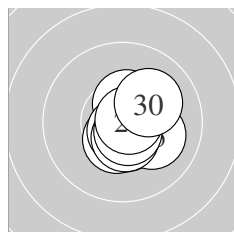

Serie 3:  
 10.5 \*                      10.5 \*                      10.5 \*                      10.5 \*                      10.1 →  
 10.7 \*                      10.5 \*                      10.7 \*                      10.8 \*                      10.1 ↗  
 beste Teiler 44.9 (29.) 59.8 (26.) 70.3 (28.)  
 Trefferlage 0.56 mm rechts, 0.20 mm tief  
 Streuwert 0.85, horizontal: 0.76, vertikal: 0.94

Unterschrift des Schützen

Ergebnis: **309.8** (297)  
 Serien: 103.2 101.8 104.8  
 Zähler: 27 3 0 0 0 0 0 0 0 0  
 Innenzehner: 22  
 weiteste: 479 (2), 365 (9), 255 (11)  
 beste Teiler 27.2 (30.) 41.5 (3.) 45.4 (8.)  
 Trefferlage 0.12 mm links, 0.25 mm hoch  
 Streuwert 1.31, horizontal: 1.63, vertikal: 0.88

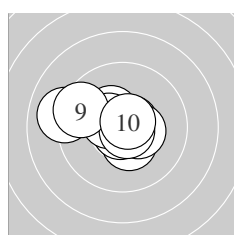
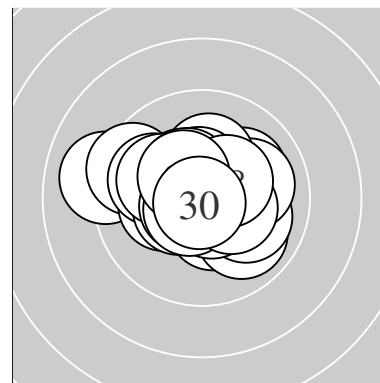

Serie 1:  
 10.4 \*                      9.0 ←                      10.8 \*                      10.7 \*                      10.4 \*  
 10.5 \*                      10.4 \*                      10.8 \*                      9.5 ↖                      10.7 \*  
 beste Teiler 41.5 (3.) 45.4 (8.) 62.2 (10.)  
 Trefferlage 0.70 mm links, 0.25 mm hoch  
 Streuwert 1.48, horizontal: 1.92, vertikal: 0.82

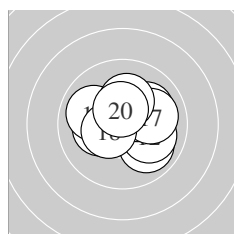

Serie 2:  
 9.9 ↘                      10.0 →                      10.4 \*                      10.1 ↗                      10.2 \*  
 10.0 ↖                      10.0 →                      10.5 \*                      10.2 \*                      10.5 \*  
 beste Teiler 121.0 (20.) 123.4 (18.) 147.5 (13.)  
 Trefferlage 0.43 mm rechts, 0.31 mm hoch  
 Streuwert 1.45, horizontal: 1.73, vertikal: 1.12

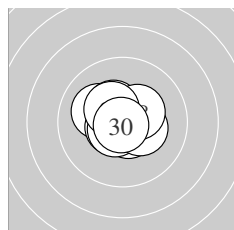

Serie 3:  
 10.5 \*                      10.1 ↖                      10.6 \*                      10.6 \*                      10.4 \*  
 10.6 \*                      10.4 \*                      10.4 \*                      10.4 \*                      10.8 \*  
 beste Teiler 27.2 (30.) 83.4 (26.) 84.3 (23.)  
 Trefferlage 0.08 mm links, 0.20 mm hoch  
 Streuwert 0.94, horizontal: 1.10, vertikal: 0.74

Unterschrift des Schützen

Meyton Elektronik



Ergebnis: **310.4** (297)  
 Serien: 104.0 102.3 104.1  
 Zähler: 27 3 0 0 0 0 0 0 0 0  
 Innenzehner: 23  
 weiteste: 295 (12), 277 (11), 254 (14)  
 beste Teiler 45.6 (22.) 50.4 (10.) 53.0 (6.)  
 Trefferlage 0.27 mm rechts, 0.42 mm hoch  
 Streuwert 1.12, horizontal: 1.22, vertikal: 1.02

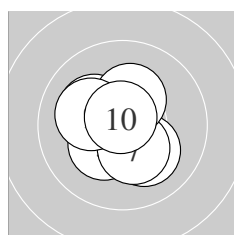
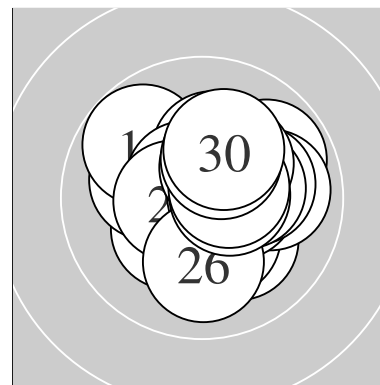

Serie 1:  
 10.2 \*                      10.1 ↘                      10.5 \*                      10.7 \*                      10.3 \*  
 10.7 \*                      10.3 \*                      10.3 \*                      10.1 ↖                      10.8 \*  
 beste Teiler 50.4 (10.) 53.0 (6.) 74.2 (4.)  
 Trefferlage 0.42 mm links, 0.02 mm hoch  
 Streuwert 1.07, horizontal: 1.08, vertikal: 1.06

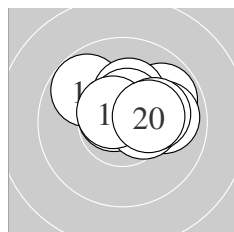

Serie 2:  
 9.8 ↗                      9.8 ↖                      10.2 \*                      9.9 →                      10.7 \*  
 10.5 \*                      10.4 \*                      10.6 \*                      10.1 →                      10.3 \*  
 beste Teiler 68.2 (15.) 85.5 (18.) 112.5 (16.)  
 Trefferlage 0.71 mm rechts, 0.83 mm hoch  
 Streuwert 1.18, horizontal: 1.52, vertikal: 0.67

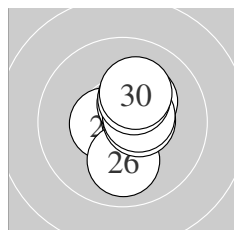

Serie 3:  
 10.3 \*                      10.8 \*                      10.5 \*                      10.6 \*                      10.4 \*  
 10.0 ↓                      10.5 \*                      10.5 \*                      10.3 \*                      10.2 \*  
 beste Teiler 45.6 (22.) 95.4 (24.) 103.4 (27.)  
 Trefferlage 0.54 mm rechts, 0.42 mm hoch  
 Streuwert 0.96, horizontal: 0.67, vertikal: 1.18

Unterschrift des Schützen

Meyton Elektronik

Ergebnis: **299.7** (287)  
 Serien: 98.6 99.3 101.8  
 Zähler: 17 13 0 0 0 0 0 0 0 0  
 Innenzehner: 9  
 weiteste: 429 (30), 389 (1), 387 (17)  
 beste Teiler 51.0 (12.) 59.0 (27.) 88.2 (28.)  
 Trefferlage 0.68 mm rechts, 1.00 mm hoch  
 Streuwert 1.64, horizontal: 2.11, vertikal: 0.98

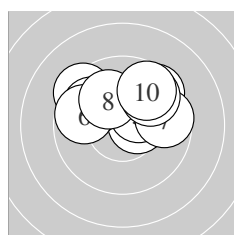
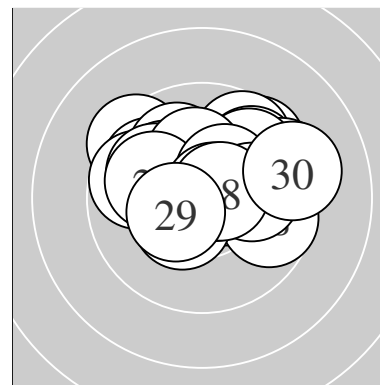

Serie 1:  
 9.4 ↘                      10.5 \*                      9.9 ↘                      9.6 ↗                      10.3 \*  
 9.7 ↙                      9.7 →                      10.1 ↘                      9.7 ↗                      9.7 ↗  
 beste Teiler 112.2 (2.) 152.8 (5.) 223.7 (8.)  
 Trefferlage 0.25 mm rechts, 1.54 mm hoch  
 Streuwert 1.79, horizontal: 2.36, vertikal: 0.91

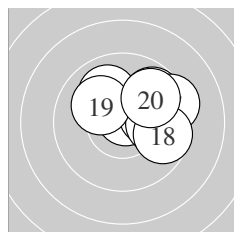

Serie 2:  
 10.0 ↘                      10.7 \*                      9.8 ↗                      10.1 →                      10.0 →  
 9.7 →                      9.4 →                      9.7 →                      10.1 ↘                      9.8 ↗  
 beste Teiler 51.0 (12.) 203.2 (14.) 209.6 (19.)  
 Trefferlage 1.60 mm rechts, 0.92 mm hoch  
 Streuwert 1.47, horizontal: 1.83, vertikal: 0.97

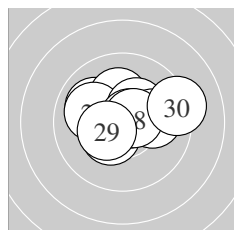

Serie 3:  
 10.0 ↘                      10.2 \*                      10.0 ↘                      10.3 \*                      10.0 →  
 10.4 \*                      10.7 \*                      10.6 \*                      10.4 \*                      9.2 →  
 beste Teiler 59.0 (27.) 88.2 (28.) 136.0 (26.)  
 Trefferlage 0.20 mm rechts, 0.53 mm hoch  
 Streuwert 1.54, horizontal: 1.98, vertikal: 0.89

Unterschrift des Schützen

Meyton Elektronik

Ergebnis: **312.0** (299)  
 Serien: 103.8 104.3 103.9  
 Zähler: 29 1 0 0 0 0 0 0 0 0  
 Innenzehner: 24  
 weiteste: 262 (10), 248 (21), 231 (3)  
 beste Teiler 55.9 (24.) 57.3 (2.) 72.8 (28.)  
 Trefferlage 0.43 mm links, 0.39 mm hoch  
 Streuwert 0.99, horizontal: 1.10, vertikal: 0.88

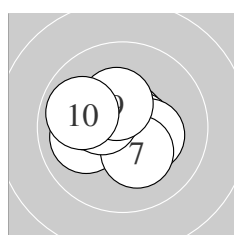
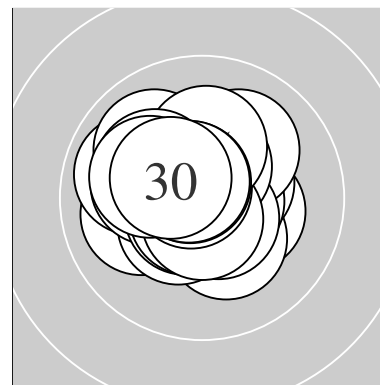

Serie 1:  
 10.6 \*                    10.7 \*                    10.0 ←                    10.6 \*                    10.6 \*  
 10.3 \*                    10.3 \*                    10.4 \*                    10.4 \*                    9.9 ↙  
 beste Teiler 57.3 (2.) 91.1 (4.) 99.0 (1.)  
 Trefferlage 0.40 mm links, 0.15 mm hoch  
 Streuwert 1.14, horizontal: 1.36, vertikal: 0.86

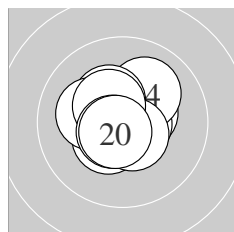

Serie 2:  
 10.4 \*                    10.4 \*                    10.6 \*                    10.1 ↗                    10.3 \*  
 10.6 \*                    10.2 \*                    10.4 \*                    10.6 \*                    10.7 \*  
 beste Teiler 75.0 (20.) 79.9 (13.) 84.8 (19.)  
 Trefferlage 0.15 mm links, 0.21 mm hoch  
 Streuwert 1.01, horizontal: 1.06, vertikal: 0.95

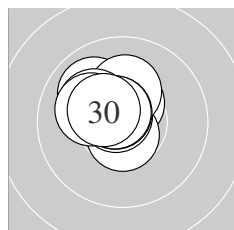

Serie 3:  
 10.0 ↘                    10.5 \*                    10.6 \*                    10.7 \*                    10.2 \*  
 10.1 ↘                    10.1 ↙                    10.7 \*                    10.6 \*                    10.4 \*  
 beste Teiler 55.9 (24.) 72.8 (28.) 77.4 (29.)  
 Trefferlage 0.74 mm links, 0.81 mm hoch  
 Streuwert 0.80, horizontal: 0.84, vertikal: 0.75

Unterschrift des Schützen

Ergebnis: **305.1** (293)  
 Serien: 99.7 102.7 102.7  
 Zähler: 25 4 0 1 0 0 0 0 0 0  
 Innenzehner: 22  
 weiteste: 950 (6), 490 (21), 329 (20)  
 beste Teiler 57.3 (27.) 64.1 (26.) 66.7 (24.)  
 Trefferlage 0.46 mm rechts, 0.12 mm hoch  
 Streuwert 1.82, horizontal: 2.28, vertikal: 1.19

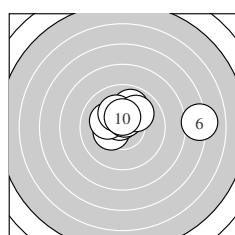
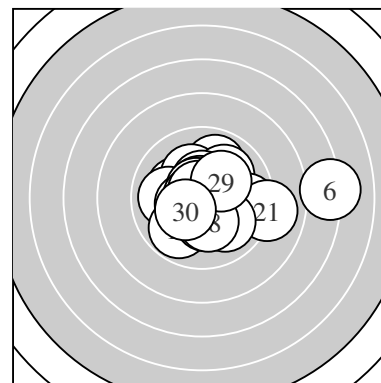

Serie 1:  
 10.2 \*                      10.3 \*                      10.7 \*                      10.2 \*                      10.5 \*  
 7.2 →                      9.9 ↗                      10.2 \*                      10.0 ↗                      10.5 \*  
 beste Teiler 72.5 (3.) 105.7 (5.) 125.0 (10.)  
 Trefferlage 0.85 mm rechts, 1.14 mm hoch  
 Streuwert 2.35, horizontal: 3.21, vertikal: 0.85

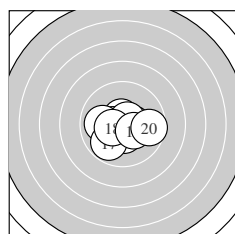

Serie 2:  
 10.6 \*                      10.5 \*                      10.4 \*                      10.0 ←                      10.4 \*  
 10.7 \*                      9.8 ↙                      10.4 \*                      10.3 \*                      9.6 →  
 beste Teiler 75.1 (16.) 87.6 (11.) 118.3 (12.)  
 Trefferlage 0.01 mm links, 0.39 mm tief  
 Streuwert 1.37, horizontal: 1.72, vertikal: 0.90

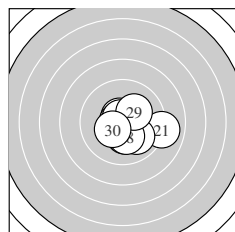

Serie 3:  
 9.0 →                      10.3 \*                      10.0 ↘                      10.7 \*                      10.6 \*  
 10.7 \*                      10.7 \*                      10.2 \*                      10.2 \*                      10.3 \*  
 beste Teiler 57.3 (27.) 64.1 (26.) 66.7 (24.)  
 Trefferlage 0.56 mm rechts, 0.38 mm tief  
 Streuwert 1.47, horizontal: 1.75, vertikal: 1.13

Unterschrift des Schützen

Meyton Elektronik

Ergebnis: **308.2** (295)  
 Serien: 102.4 103.2 102.6  
 Zähler: 25 5 0 0 0 0 0 0 0 0  
 Innenzehner: 21  
 weiteste: 384 (16), 284 (30), 278 (7)  
 beste Teiler 66.6 (13.) 67.9 (8.) 69.1 (12.)  
 Trefferlage 0.48 mm links, 0.33 mm hoch  
 Streuwert 1.29, horizontal: 1.47, vertikal: 1.07

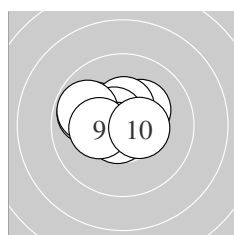
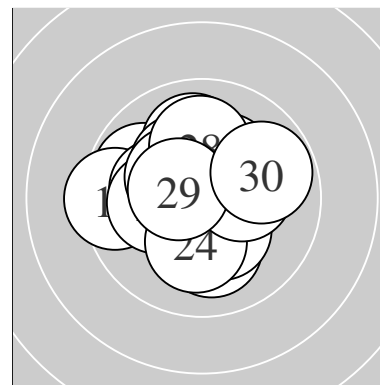

Serie 1:  
 9.9 ↖ 10.0 ↖ 10.3 \* 10.4 \* 9.9 ↖  
 10.6 \* 9.8 ↖ 10.7 \* 10.3 \* 10.5 \*  
 beste Teiler 67.9 (8.) 84.2 (6.) 123.6 (10.)  
 Trefferlage 0.97 mm links, 0.57 mm hoch  
 Streuwert 1.17, horizontal: 1.51, vertikal: 0.66

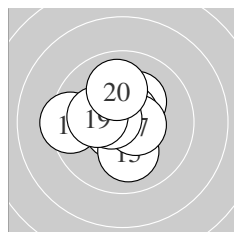

Serie 2:  
 10.2 \* 10.7 \* 10.7 \* 10.7 \* 10.1 ↓  
 9.4 ← 10.6 \* 10.6 \* 10.2 \* 10.0 ↑  
 beste Teiler 66.6 (13.) 69.1 (12.) 73.8 (14.)  
 Trefferlage 0.51 mm links, 0.17 mm hoch  
 Streuwert 1.34, horizontal: 1.45, vertikal: 1.21

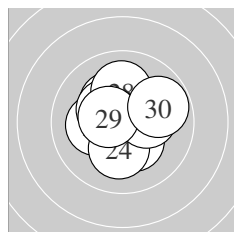

Serie 3:  
 10.7 \* 10.3 \* 10.2 \* 10.2 \* 10.3 \*  
 10.4 \* 10.2 \* 10.0 ↑ 10.5 \* 9.8 →  
 beste Teiler 73.0 (21.) 109.7 (29.) 149.4 (26.)  
 Trefferlage 0.03 mm rechts, 0.25 mm hoch  
 Streuwert 1.35, horizontal: 1.42, vertikal: 1.28

Unterschrift des Schützen

Ergebnis: **309.2** (293)  
 Serien: 102.5 103.0 103.7  
 Zähler: 23 7 0 0 0 0 0 0 0 0  
 Innenzehner: 21  
 weiteste: 346 (19), 318 (29), 308 (10)  
 beste Teiler 10.1 (2.) 10.6 (15.) 35.0 (21.)  
 Trefferlage 0.36 mm rechts, 0.22 mm hoch  
 Streuwert 1.31, horizontal: 1.56, vertikal: 1.00

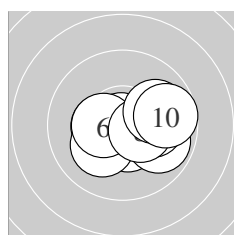
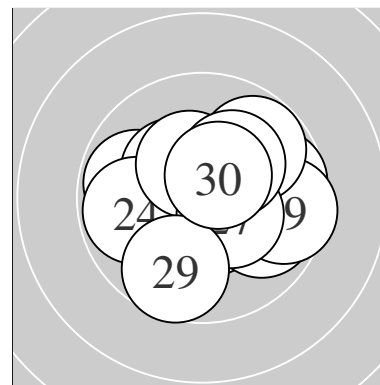

Serie 1:  
 10.4 \*                      10.9 \*                      10.5 \*                      10.2 \*                      9.9 ↘  
 10.4 \*                      10.1 →                      10.4 \*                      10.0 →                      9.7 →  
 beste Teiler 10.1 (2.) 108.1 (3.) 129.8 (8.)  
 Trefferlage 0.72 mm rechts, 0.23 mm tief  
 Streuwert 1.33, horizontal: 1.73, vertikal: 0.75

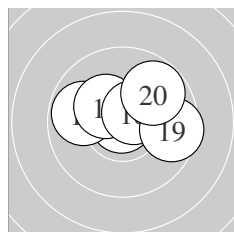

Serie 2:  
 10.6 \*                      10.6 \*                      10.3 \*                      10.6 \*                      10.9 \*  
 9.8 ←                      10.3 \*                      10.5 \*                      9.6 →                      9.8 ↗  
 beste Teiler 10.6 (15.) 79.1 (12.) 83.5 (14.)  
 Trefferlage 0.46 mm rechts, 0.69 mm hoch  
 Streuwert 1.30, horizontal: 1.71, vertikal: 0.66

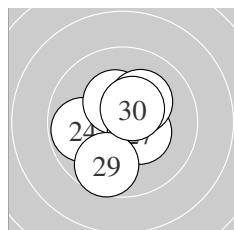

Serie 3:  
 10.8 \*                      10.8 \*                      10.6 \*                      9.8 ←                      10.5 \*  
 10.4 \*                      10.4 \*                      10.2 \*                      9.7 ↓                      10.5 \*  
 beste Teiler 35.0 (21.) 50.4 (22.) 91.6 (23.)  
 Trefferlage 0.09 mm links, 0.20 mm hoch  
 Streuwert 1.28, horizontal: 1.22, vertikal: 1.33

Unterschrift des Schützen

Ergebnis: **308.9** (294)  
 Serien: 103.1 104.7 101.1  
 Zähler: 24 6 0 0 0 0 0 0 0 0  
 Innenzehner: 20  
 weiteste: 312 (23), 305 (26), 297 (4)  
 beste Teiler 48.2 (6.) 58.0 (17.) 62.1 (21.)  
 Trefferlage 0.27 mm links, 0.70 mm hoch  
 Streuwert 1.19, horizontal: 1.22, vertikal: 1.17

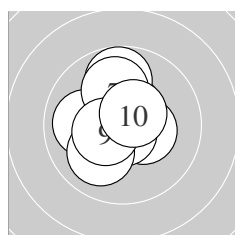
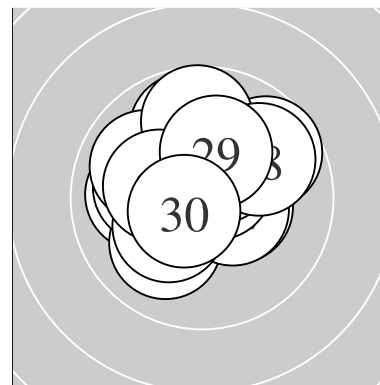

Serie 1:  
 10.5 \*                      10.6 \*                      10.0 ←                      9.8 ↑                      10.4 \*  
 10.8 \*                      10.0 ↑                      10.0 ↙                      10.5 \*                      10.5 \*  
 beste Teiler 48.2 (6.) 85.4 (2.) 104.8 (10.)  
 Trefferlage 0.41 mm links, 0.46 mm hoch  
 Streuwert 1.26, horizontal: 1.10, vertikal: 1.41

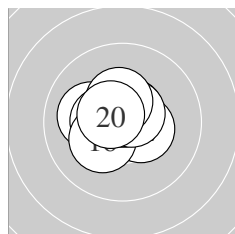

Serie 2:  
 10.6 \*                      10.4 \*                      10.1 ←                      10.6 \*                      10.4 \*  
 10.3 \*                      10.7 \*                      10.6 \*                      10.4 \*                      10.6 \*  
 beste Teiler 58.0 (17.) 77.9 (11.) 82.0 (18.)  
 Trefferlage 0.41 mm links, 0.27 mm hoch  
 Streuwert 0.87, horizontal: 1.02, vertikal: 0.68

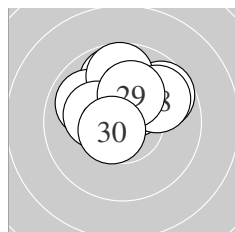

Serie 3:  
 10.7 \*                      10.4 \*                      9.7 ↘                      9.8 ↑                      9.9 ↖  
 9.7 ↑                      10.2 \*                      9.9 ↘                      10.2 \*                      10.6 \*  
 beste Teiler 62.1 (21.) 89.4 (30.) 141.9 (22.)  
 Trefferlage 0.00 mm , 1.37 mm hoch  
 Streuwert 1.34, horizontal: 1.55, vertikal: 1.09

Unterschrift des Schützen

Ergebnis: **307.9** (295)  
 Serien: 101.4 102.2 104.3  
 Zähler: 25 5 0 0 0 0 0 0 0 0  
 Innenzehner: 19  
 weiteste: 403 (3), 355 (16), 318 (6)  
 beste Teiler 37.1 (9.) 49.8 (24.) 51.0 (29.)  
 Trefferlage 0.34 mm rechts, 0.00 mm  
 Streuwert 1.38, horizontal: 1.61, vertikal: 1.09

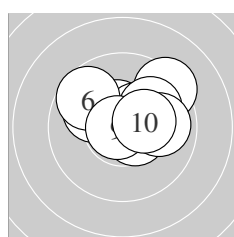
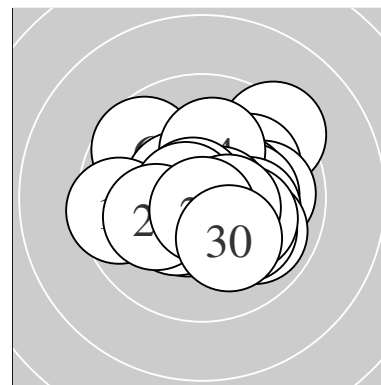

Serie 1:  
 10.5 \*                      10.0 ↘                      9.3 ↗                      10.4 \*                      10.5 \*  
 9.7 ↘                      10.0 ↗                      9.9 →                      10.8 \*                      10.3 \*  
 beste Teiler 37.1 (9.) 101.1 (5.) 116.7 (1.)  
 Trefferlage 0.57 mm rechts, 0.92 mm hoch  
 Streuwert 1.47, horizontal: 1.84, vertikal: 0.96

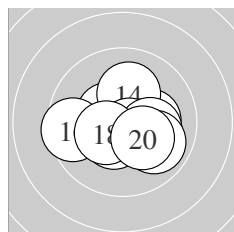

Serie 2:  
 10.5 \*                      10.2 \*                      10.5 \*                      10.1 ↑                      10.7 \*  
 9.5 ←                      10.2 \*                      10.4 \*                      9.9 ↘                      10.2 \*  
 beste Teiler 73.0 (15.) 116.3 (11.) 124.0 (13.)  
 Trefferlage 0.20 mm rechts, 0.32 mm tief  
 Streuwert 1.46, horizontal: 1.80, vertikal: 1.00

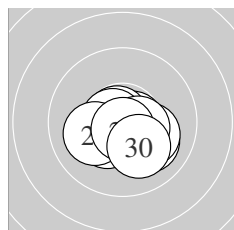

Serie 3:  
 10.1 ↘                      10.2 \*                      10.7 \*                      10.8 \*                      10.7 \*  
 10.4 \*                      10.5 \*                      10.1 ←                      10.7 \*                      10.1 ↘  
 beste Teiler 49.8 (24.) 51.0 (29.) 69.2 (23.)  
 Trefferlage 0.24 mm rechts, 0.62 mm tief  
 Streuwert 1.00, horizontal: 1.26, vertikal: 0.64

Unterschrift des Schützen



Ergebnis: **304.0** (289)  
 Serien: 100.1 102.0 101.9  
 Zähler: 19 11 0 0 0 0 0 0 0 0  
 Innenzehner: 16  
 weiteste: 495 (2), 492 (13), 405 (25)  
 beste Teiler 12.1 (24.) 39.5 (5.) 51.0 (15.)  
 Trefferlage 0.16 mm rechts, 0.28 mm hoch  
 Streuwert 1.68, horizontal: 2.16, vertikal: 1.01

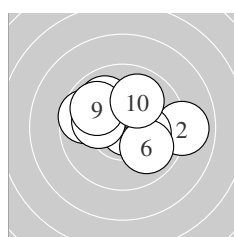
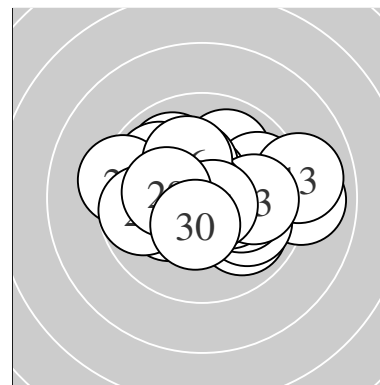

Serie 1:  
 9.7 ←                      9.0 →                      10.6 \*                      10.2 \*                      10.8 \*  
 9.9 ↘                      9.9 ↘                      10.1 ←                      9.9 ↘                      10.0 ↗  
 beste Teiler 39.5 (5.) 94.1 (3.) 185.7 (4.)  
 Trefferlage 0.22 mm rechts, 0.54 mm hoch  
 Streuwert 1.92, horizontal: 2.44, vertikal: 1.18

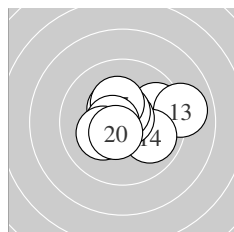

Serie 2:  
 9.8 →                      10.4 \*                      9.0 →                      9.9 ↘                      10.7 \*  
 10.6 \*                      10.3 \*                      10.6 \*                      10.2 \*                      10.5 \*  
 beste Teiler 51.0 (15.) 85.0 (18.) 85.2 (16.)  
 Trefferlage 0.60 mm rechts, 0.29 mm hoch  
 Streuwert 1.59, horizontal: 2.03, vertikal: 0.98

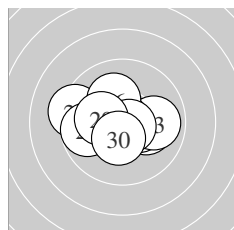

Serie 3:  
 10.1 →                      10.4 \*                      9.9 →                      10.9 \*                      9.3 ←  
 10.2 \*                      10.7 \*                      9.8 ←                      10.2 \*                      10.4 \*  
 beste Teiler 12.1 (24.) 64.3 (27.) 137.1 (22.)  
 Trefferlage 0.33 mm links, 0.00 mm  
 Streuwert 1.61, horizontal: 2.10, vertikal: 0.88

Unterschrift des Schützen

Ergebnis: **304.0** (289)  
 Serien: 100.5 102.1 101.4  
 Zähler: 19 11 0 0 0 0 0 0 0 0  
 Innenzehner: 16  
 weiteste: 439 (18), 412 (24), 394 (3)  
 beste Teiler 3.1 (19.) 12.0 (16.) 24.0 (9.)  
 Trefferlage 0.22 mm rechts, 0.36 mm tief  
 Streuwert 1.68, horizontal: 1.72, vertikal: 1.63

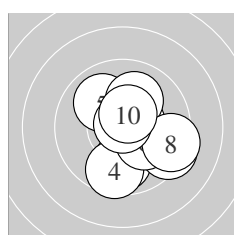
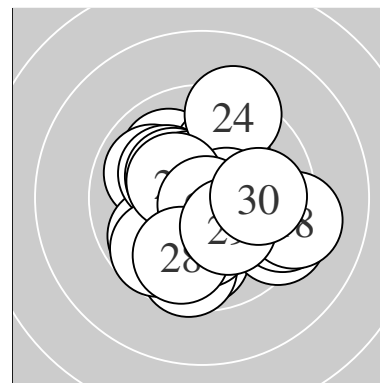

Serie 1:  
 10.5 \* 9.9 ↓ 9.4 ↘ 9.6 ↓ 10.0 ↘  
 10.2 \* 10.1 ↑ 9.4 → 10.9 \* 10.5 \*  
 beste Teiler 24.0 (9.) 109.5 (1.) 109.9 (10.)  
 Trefferlage 0.90 mm rechts, 0.44 mm tief  
 Streuwert 1.77, horizontal: 1.69, vertikal: 1.85

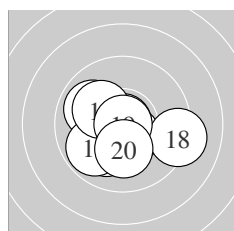

Serie 2:  
 10.1 ↙ 9.9 ↖ 10.4 \* 9.8 ↙ 10.5 \*  
 10.9 \* 10.2 \* 9.2 → 10.9 \* 10.2 \*  
 beste Teiler 3.1 (19.) 12.0 (16.) 108.0 (15.)  
 Trefferlage 0.26 mm links, 0.64 mm tief  
 Streuwert 1.58, horizontal: 1.89, vertikal: 1.18

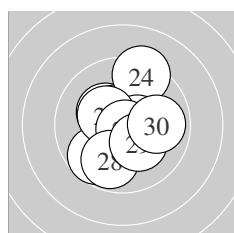

Serie 3:  
 9.7 ↙ 10.3 \* 10.5 \* 9.3 ↑ 10.5 \*  
 10.4 \* 10.8 \* 9.8 ↓ 10.2 \* 9.9 →  
 beste Teiler 35.8 (27.) 103.4 (23.) 113.2 (25.)  
 Trefferlage 0.04 mm rechts, 0.00 mm  
 Streuwert 1.70, horizontal: 1.51, vertikal: 1.88

Unterschrift des Schützen

Ergebnis: **309.5** (295)  
 Serien: 103.9 103.2 102.4  
 Zähler: 25 5 0 0 0 0 0 0 0 0  
 Innenzehner: 24  
 weiteste: 373 (30), 367 (15), 366 (23)  
 beste Teiler 5.0 (1.) 41.1 (25.) 55.9 (10.)  
 Trefferlage 0.20 mm rechts, 0.12 mm tief  
 Streuwert 1.34, horizontal: 1.69, vertikal: 0.85

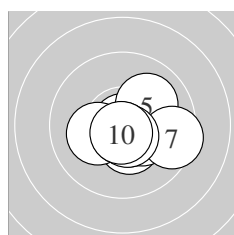
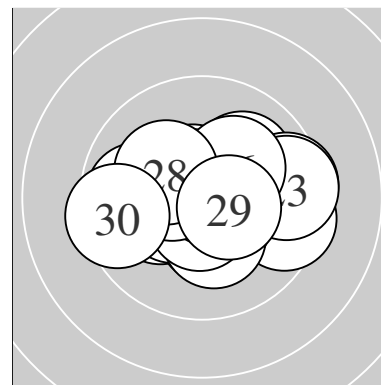

Serie 1:  
 10.9 \*                      10.4 \*                      10.6 \*                      10.3 \*                      10.0 ↗  
 10.2 \*                      9.5 →                      10.7 \*                      10.6 \*                      10.7 \*  
 beste Teiler 5.0 (1.) 55.9 (10.) 58.2 (8.)  
 Trefferlage 0.61 mm rechts, 0.46 mm tief  
 Streuwert 1.13, horizontal: 1.40, vertikal: 0.76

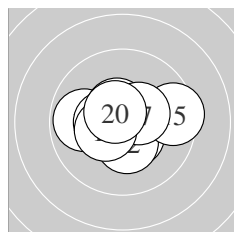

Serie 2:  
 10.5 \*                      10.4 \*                      10.5 \*                      9.9 ←                      9.5 →  
 10.6 \*                      10.4 \*                      10.4 \*                      10.4 \*                      10.6 \*  
 beste Teiler 90.8 (20.) 100.7 (16.) 113.2 (13.)  
 Trefferlage 0.14 mm links, 0.01 mm hoch  
 Streuwert 1.35, horizontal: 1.75, vertikal: 0.78

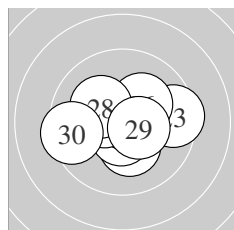

Serie 3:  
 10.3 \*                      10.6 \*                      9.5 →                      10.4 \*                      10.8 \*  
 10.2 \*                      10.4 \*                      10.2 \*                      10.5 \*                      9.5 ←  
 beste Teiler 41.1 (25.) 90.5 (22.) 123.0 (29.)  
 Trefferlage 0.14 mm rechts, 0.06 mm hoch  
 Streuwert 1.55, horizontal: 1.97, vertikal: 0.97

Unterschrift des Schützen

Ergebnis: **309.9** (295)  
 Serien: 100.0 104.2 105.7  
 Zähler: 25 5 0 0 0 0 0 0 0 0  
 Innenzehner: 20  
 weiteste: 352 (4), 311 (6), 292 (5)  
 beste Teiler 6.3 (22.) 39.5 (13.) 43.1 (28.)  
 Trefferlage 0.27 mm links, 0.37 mm tief  
 Streuwert 1.24, horizontal: 1.12, vertikal: 1.34

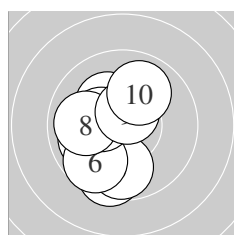
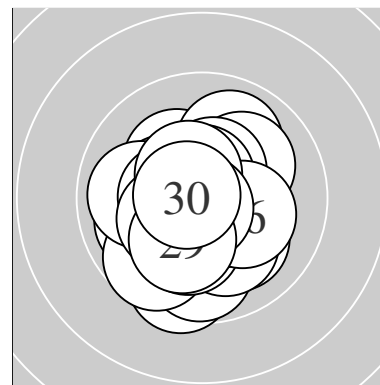

Serie 1:  
 10.2 \*                      10.0 ←                      10.1 ←                      9.5 ↓                      9.8 ↓  
 9.7 ↗                      10.3 \*                      9.9 ←                      10.6 \*                      9.9 ↗  
 beste Teiler 97.7 (9.) 154.2 (7.) 181.2 (1.)  
 Trefferlage 1.05 mm links, 0.54 mm tief  
 Streuwert 1.60, horizontal: 1.20, vertikal: 1.92

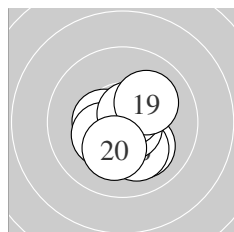

Serie 2:  
 10.1 ↘                      10.8 \*                      10.8 \*                      10.4 \*                      10.3 \*  
 10.1 ↘                      10.7 \*                      10.7 \*                      10.1 ↗                      10.2 \*  
 beste Teiler 39.5 (13.) 46.4 (12.) 65.0 (17.)  
 Trefferlage 0.19 mm rechts, 0.46 mm tief  
 Streuwert 1.06, horizontal: 1.03, vertikal: 1.09

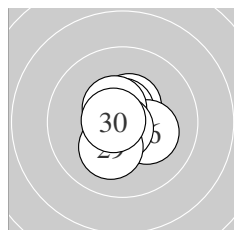

Serie 3:  
 10.5 \*                      10.9 \*                      10.7 \*                      10.6 \*                      10.6 \*  
 10.2 \*                      10.5 \*                      10.8 \*                      10.2 \*                      10.7 \*  
 beste Teiler 6.3 (22.) 43.1 (28.) 54.3 (23.)  
 Trefferlage 0.02 mm rechts, 0.10 mm tief  
 Streuwert 0.82, horizontal: 0.73, vertikal: 0.90

Unterschrift des Schützen