

Ergebnis: **185.2** (178)
 Serien: 91.6 93.6
 Zähler: 9 3 5 3 0 0 0 0 0 0 0
 Innenzehner: 5
 Weitester: 955 (2.), 894 (11.), 811 (1.)
 beste Teiler: 103.3 (10.), 142.1 (19.), 160.6 (5.)
 Trefferlage: 0.81 mm links, 1.08 mm tief
 Streuwert: 3.45, horizontal: 3.72, vertikal: 3.15

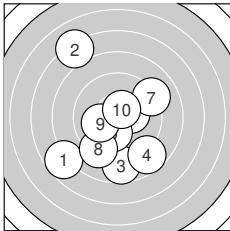

Serie 1: 91.6 (88)

7.7 ↙ 7.1 ↖ 8.7 ↓ 8.7 ↘ 10.3* →
 10.2* ↓ 9.1 ↗ 9.2 ↘ 10.1 ← 10.5* ↗
 beste Teiler: 103.3 (10.), 160.6 (5.), 189.0 (6.)
 Trefferlage: 0.63 mm links, 0.95 mm tief
 Streuwert: 3.80, horizontal: 3.38, vertikal: 4.19

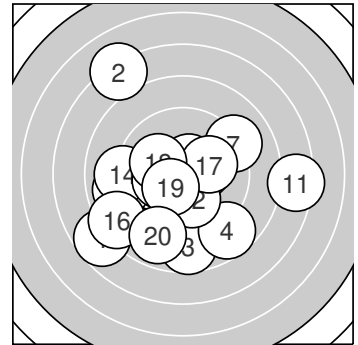
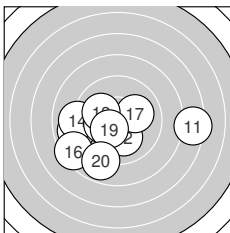

Serie 2: 93.6 (90)

7.4 → 10.1 ↓ 8.9 ← 9.1 ← 10.2* ←
 8.4 ↙ 10.1 → 10.1 ↖ 10.4* ↗ 8.9 ↓
 beste Teiler: 142.1 (19.), 182.4 (15.), 210.3 (12.)
 Trefferlage: 0.98 mm links, 1.21 mm tief
 Streuwert: 3.25, horizontal: 4.22, vertikal: 1.83



Ergebnis: **188.2** (178)
 Serien: 94.4 93.8
 Zähler: 2 15 2 1 0 0 0 0 0 0
 Innenzehner: 1
 Weitestе: 833 (13.), 644 (5.), 608 (3.)
 beste Teiler: 145.0 (2.), 219.4 (17.), 268.0 (7.)
 Trefferlage: 0.16 mm links, 0.05 mm hoch
 Streuwert: 3.03, horizontal: 3.79, vertikal: 1.99

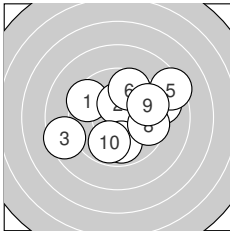
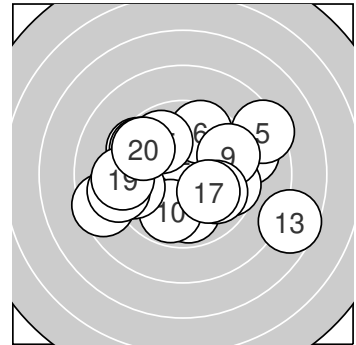

Serie 1: 94.4 (89)

9.5 ↘ 10.4* ↑ 8.5 ← 9.0 → 8.4 ↗
 9.7 ↑ 9.9 ↓ 9.6 → 9.6 → 9.8 ↓

beste Teiler: 145.0 (2.), 268.0 (7.), 277.6 (10.)
 Trefferlage: 0.87 mm rechts, 0.38 mm hoch
 Streuwert: 2.96, horizontal: 3.53, vertikal: 2.24

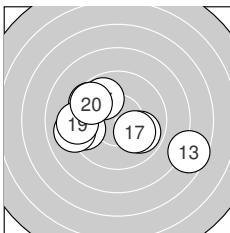

Serie 2: 93.8 (89)

9.4 ← 9.9 ↘ 7.6 → 9.5 ← 9.8 ↗
 9.6 ↘ 10.1 ↘ 9.1 ← 9.2 ← 9.6 ↘

beste Teiler: 219.4 (17.), 268.0 (12.), 276.5 (15.)
 Trefferlage: 1.19 mm links, 0.26 mm tief
 Streuwert: 3.05, horizontal: 3.94, vertikal: 1.76



Ergebnis: **188.7** (180)
 Serien: 92.8 95.9
 Zähler: 9 6 3 1 0 1 0 0 0 0 0
 Innenzehner: 7
 Weitester: 1275 (4.), 827 (19.), 674 (7.)
 beste Teiler: 36.6 (12.), 76.1 (14.), 96.7 (18.)
 Trefferlage: 0.54 mm rechts, 1.03 mm tief
 Streuwert: 3.39, horizontal: 4.44, vertikal: 1.80

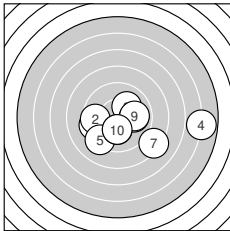
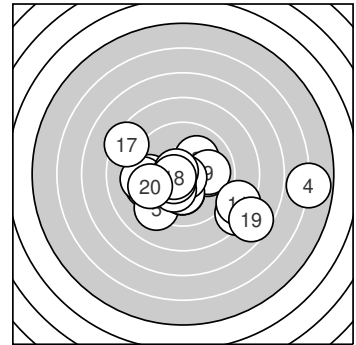

Serie 1: 92.8 (89)

9.4 ←	9.6 ←	10.1 ↗	5.9 →	9.2 ✓
10.2* ↓	8.3 ↘	10.0 →	9.9 →	10.2* ↓

beste Teiler: 185.1 (10.), 187.0 (6.), 213.5 (3.)
 Trefferlage: 1.48 mm rechts, 1.18 mm tief
 Streuwert: 3.66, horizontal: 4.89, vertikal: 1.69

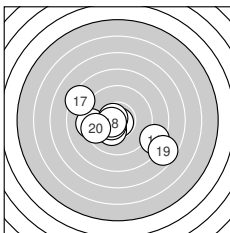

Serie 2: 95.9 (91)

8.4 ↘	10.8* ↓	9.3 ←	10.6* ↖	10.2* ✓
10.5* ↙	8.4 ↖	10.6* ←	7.6 ↘	9.5 ←

beste Teiler: 36.6 (12.), 76.1 (14.), 96.7 (18.)
 Trefferlage: 0.39 mm links, 0.88 mm tief
 Streuwert: 3.13, horizontal: 3.95, vertikal: 1.99



Ergebnis: **200.0** (191)
 Serien: 100.2 99.8
 Zähler: 11 9 0 0 0 0 0 0 0 0
 Innenzehner: 9
 Weitestе: 413 (5.), 394 (18.), 381 (19.)
 beste Teiler: 63.5 (16.), 82.8 (9.), 85.2 (14.)
 Trefferlage: 0.35 mm links, 0.36 mm tief
 Streuwert: 1.90, horizontal: 2.51, vertikal: 0.96

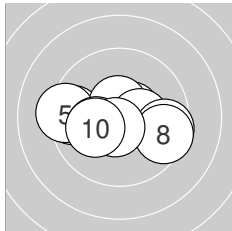
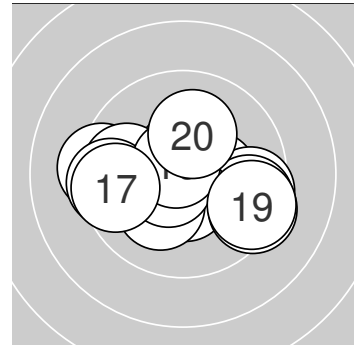

Serie 1: 100.2 (96)

9.5 ←	10.6* ↗	10.6* ↑	10.3* →	9.3 ←
10.2* ←	9.5 →	9.5 →	10.6* ↓	10.1 ←

beste Teiler: 82.8 (9.), 91.7 (3.), 95.2 (2.)
 Trefferlage: 0.26 mm links, 0.26 mm tief
 Streuwert: 1.92, horizontal: 2.62, vertikal: 0.71

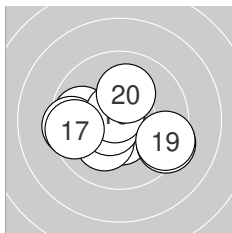

Serie 2: 99.8 (95)

10.5* ↓	9.8 ←	10.2* ↙	10.6* ←	9.5 ←
10.7* ↘	9.6 ←	9.4 ↘	9.4 →	10.1 ↑

beste Teiler: 63.5 (16.), 85.2 (14.), 116.6 (11.)
 Trefferlage: 0.45 mm links, 0.47 mm tief
 Streuwert: 1.98, horizontal: 2.54, vertikal: 1.18



Ergebnis: **186.7** (178)
 Serien: 95.2 91.5
 Zähler: 6 7 6 1 0 0 0 0 0 0 0
 Innenzehner: 5
 Weitestе: 852 (14.), 739 (11.), 703 (3.)
 beste Teiler: 25.0 (12.), 89.9 (17.), 140.0 (8.)
 Trefferlage: 1.17 mm rechts, 0.00 mm
 Streuwert: 3.28, horizontal: 4.19, vertikal: 2.01

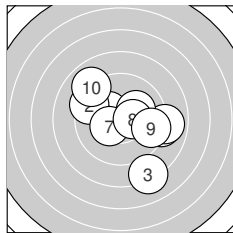
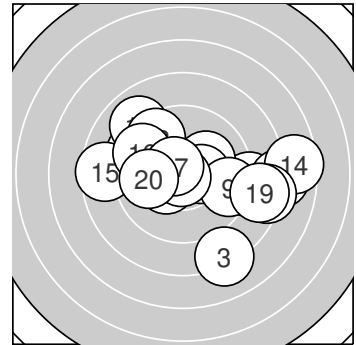

Serie 1: 95.2 (92)

10.3* ↖ 9.4 ↖ 8.1 ↘
 10.1 ↗ 10.4* ↗ 10.4* →
 beste Teiler: 140.0 (8.), 149.5 (7.), 164.7 (1.)
 Trefferlage: 0.99 mm rechts, 0.21 mm tief
 Streuwert: 2.91, horizontal: 3.20, vertikal: 2.59

9.1 → 8.9 →
 9.5 → 9.0 ↘

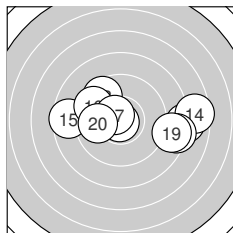

Serie 2: 91.5 (86)

8.0 → 10.9* ↙ 9.6 ↘ 7.5 → 8.6 ←
 9.6 ↖ 10.6* ↖ 8.3 → 8.5 → 9.9 ←
 beste Teiler: 25.0 (12.), 89.9 (17.), 263.4 (20.)
 Trefferlage: 1.36 mm rechts, 0.20 mm hoch
 Streuwert: 3.77, horizontal: 5.16, vertikal: 1.31



Ergebnis: **207.3** (198)
 Serien: 103.4 103.9
 Zähler: 18 2 0 0 0 0 0 0 0 0
 Innenzehner: 16
 Weitesten: 376 (4.), 272 (12.), 230 (18.)
 beste Teiler: 2.2 (14.), 41.4 (17.), 47.6 (1.)
 Trefferlage: 0.09 mm rechts, 0.20 mm tief
 Streuwert: 1.20, horizontal: 1.13, vertikal: 1.26

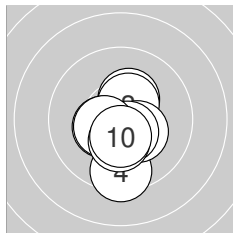
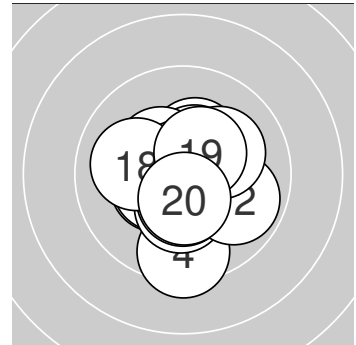

Serie 1: 103.4 (99)

10.8* →	10.3* ↗	10.5* ↗	9.4 ↓	10.3* ↘
10.5* ↘	10.4* ↙	10.4* ↙	10.3* ↓	10.5* ↓

beste Teiler: 47.6 (1.), 106.5 (6.), 124.3 (3.)
 Trefferlage: 0.08 mm rechts, 0.70 mm tief
 Streuwert: 1.17, horizontal: 0.79, vertikal: 1.45

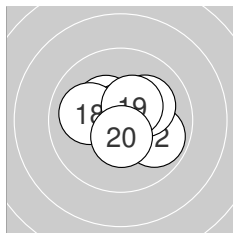

Serie 2: 103.9 (99)

10.3* ↖	9.9 ↘	10.6* ↗	10.9* ↖	10.1 ↗
10.4* ↖	10.8* ↗	10.0 ↖	10.4* ↗	10.5* ↓

beste Teiler: 2.2 (14.), 41.4 (17.), 95.2 (13.)
 Trefferlage: 0.10 mm rechts, 0.28 mm hoch
 Streuwert: 1.18, horizontal: 1.43, vertikal: 0.84



Ergebnis: **23.1** (22)
 Serien: 23.1
 Zähler: 0 0 2 0 1 0 0 0 0 0 0
 Innenzehner: 0
 Weitesten: 1018 (1.), 732 (3.), 687 (2.)
 beste Teiler: 687.9 (2.), 732.2 (3.), 1018.2 (1.)
 Trefferlage: 8.02 mm rechts, 0.44 mm hoch
 Streuwert: 1.64, horizontal: 1.83, vertikal: 1.43

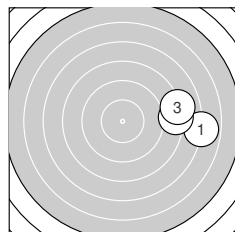
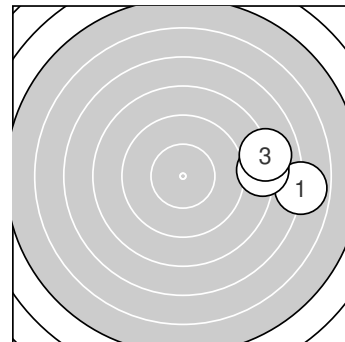

Serie 1: 23.1 (22)

6.9 → 8.2 → 8.0 →
 beste Teiler: 687.9 (2.), 732.2 (3.), 1018.2 (1.)
 Trefferlage: 8.02 mm rechts, 0.44 mm hoch
 Streuwert: 1.64, horizontal: 1.83, vertikal: 1.43



Ergebnis: **194.4** (185)
 Serien: 98.6 95.8
 Zähler: 7 11 2 0 0 0 0 0 0 0
 Innenzehner: 5
 Weitester: 552 (13.), 538 (16.), 484 (3.)
 beste Teiler: 68.1 (10.), 146.4 (5.), 149.3 (2.)
 Trefferlage: 0.28 mm links, 0.47 mm tief
 Streuwert: 2.40, horizontal: 2.62, vertikal: 2.15

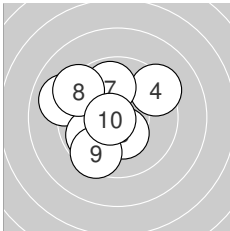
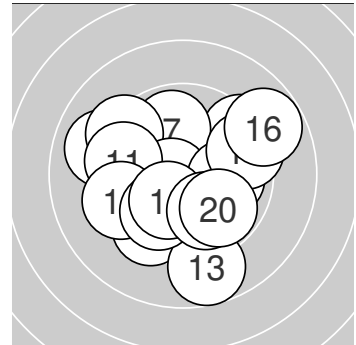

Serie 1: 98.6 (94)

10.2* ↙	10.4* ↙	9.0 ↖
9.9 ↙	9.9 ↑	9.3 ↘

beste Teiler: 68.1 (10.), 146.4 (5.), 149.3 (2.)
 Trefferlage: 1.18 mm links, 0.04 mm hoch
 Streuwert: 2.09, horizontal: 2.16, vertikal: 2.01

9.3 ↗	10.4* ↓
9.5 ↙	10.7* ↖

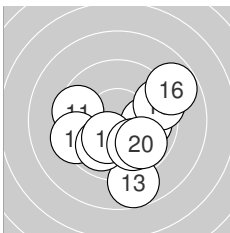

Serie 2: 95.8 (91)

9.5 ↖	10.0 →	8.7 ↓
8.8 ↗	9.9 ↙	10.3* ↙

beste Teiler: 174.7 (18.), 249.2 (19.), 250.0 (12.)
 Trefferlage: 0.61 mm rechts, 0.99 mm tief
 Streuwert: 2.57, horizontal: 2.84, vertikal: 2.26

9.4 ↖	9.4 →
10.0 ↘	9.8 ↘



Ergebnis: **196.4** (188)
 Serien: 97.0 99.4
 Zähler: 9 10 1 0 0 0 0 0 0 0
 Innenzehner: 7
 Weitester: 553 (5.), 460 (6.), 438 (10.)
 beste Teiler: 80.6 (1.), 83.5 (17.), 168.7 (15.)
 Trefferlage: 0.53 mm links, 1.26 mm hoch
 Streuwert: 2.00, horizontal: 2.34, vertikal: 1.60

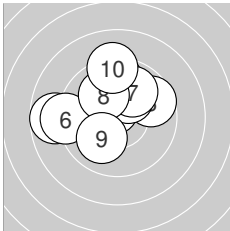
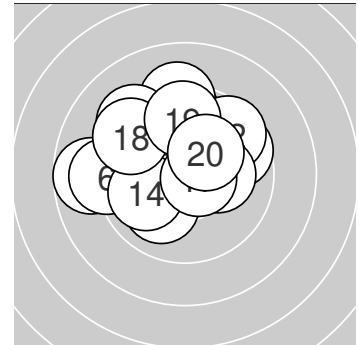

Serie 1: 97.0 (93)

10.6* ↘ 9.7 ↑ 9.6 ↗
 9.1 ← 9.9 ↗ 10.0 ↘
 beste Teiler: 80.6 (1.), 194.7 (4.), 230.8 (8.)
 Trefferlage: 0.83 mm links, 1.35 mm hoch
 Streuwert: 2.22, horizontal: 2.58, vertikal: 1.79

10.2* ↗ 8.7 ←
 10.0 ↘ 9.2 ↑

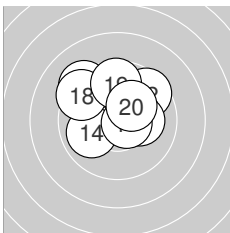

Serie 2: 99.4 (95)

9.3 ↘ 9.6 ↗ 10.2* ↖
 10.2* → 10.6* → 9.4 ↘
 beste Teiler: 83.5 (17.), 168.7 (15.), 176.7 (20.)
 Trefferlage: 0.22 mm links, 1.16 mm hoch
 Streuwert: 1.86, horizontal: 2.17, vertikal: 1.49

9.9 ↖ 10.3* →
 9.7 ↑ 10.2* ↗



Ergebnis: **190.9** (182)
 Serien: 90.9 100.0
 Zähler: 9 6 4 0 1 0 0 0 0 0 0
 Innenzehner: 6
 Weitestе: 1128 (4.), 606 (7.), 542 (9.)
 beste Teiler: 78.6 (3.), 87.1 (20.), 101.5 (19.)
 Trefferlage: 0.11 mm rechts, 0.58 mm tief
 Streuwert: 3.05, horizontal: 3.50, vertikal: 2.53

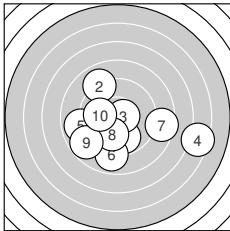
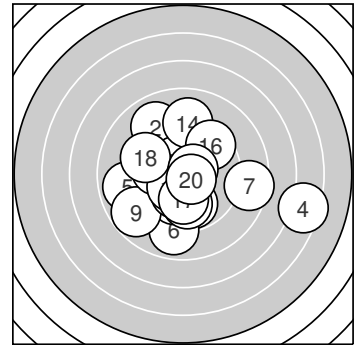

Serie 1: 90.9 (86)

9.8 ↓ 9.0 ↖ 10.6* →
 8.9 ↓ 8.5 → 10.0 ↓

6.4 → 8.9 ←
 8.8 ↙ 10.0 ←

beste Teiler: 78.6 (3.), 241.5 (10.), 242.8 (8.)
 Trefferlage: 0.28 mm rechts, 1.38 mm tief
 Streuwert: 3.88, horizontal: 4.83, vertikal: 2.59

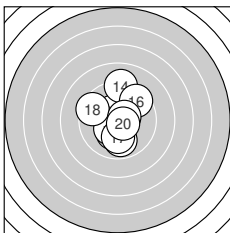

Serie 2: 100.0 (96)

10.4* ↖ 9.9 ↓ 10.2* ↓
 9.5 ↗ 10.0 ↓ 9.5 ↖

9.1 ↑ 10.3* ↙
 10.5* → 10.6* ↘

beste Teiler: 87.1 (20.), 101.5 (19.), 132.8 (11.)
 Trefferlage: 0.05 mm links, 0.20 mm hoch
 Streuwert: 1.97, horizontal: 1.54, vertikal: 2.33



Ergebnis: **192.6** (184)
 Serien: 95.3 97.3
 Zähler: 8 8 4 0 0 0 0 0 0 0
 Innenzehner: 5
 Weitesten: 692 (4.), 646 (9.), 569 (20.)
 beste Teiler: 27.6 (3.), 80.0 (13.), 171.2 (16.)
 Trefferlage: 1.02 mm links, 0.06 mm hoch
 Streuwert: 2.61, horizontal: 2.80, vertikal: 2.41

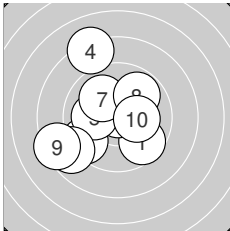
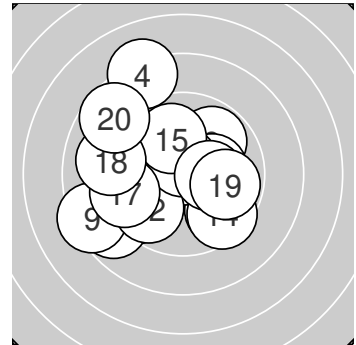

Serie 1: 95.3 (91)

9.6 ↘ 9.4 ↙ 10.8* ↑
 8.8 ↙ 10.0 ↘ 9.8 ↗
 beste Teiler: 27.6 (3.), 185.6 (10.), 222.1 (5.)
 Trefferlage: 1.36 mm links, 0.00 mm
 Streuwert: 2.88, horizontal: 2.82, vertikal: 2.93

8.2 ↖ 10.1 ←
 8.4 ↖ 10.2* →

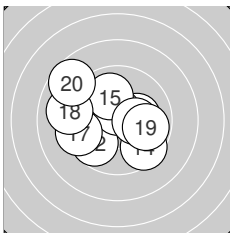

Serie 2: 97.3 (93)

10.2* → 9.7 ↙ 10.6* ↑
 10.3* → 9.4 ↖ 9.1 ←
 beste Teiler: 80.0 (13.), 171.2 (16.), 190.0 (11.)
 Trefferlage: 0.69 mm links, 0.12 mm hoch
 Streuwert: 2.45, horizontal: 2.90, vertikal: 1.91

9.5 ↘ 10.0 ↖
 9.8 → 8.7 ↘



Ergebnis: **179.7** (172)
 Serien: 89.5 90.2
 Zähler: 3 8 7 2 0 0 0 0 0 0 0
 Innenzehner: 2
 Weitester: 901 (19.), 806 (13.), 748 (7.)
 beste Teiler: 159.0 (20.), 169.9 (5.), 213.5 (16.)
 Trefferlage: 0.43 mm rechts, 0.40 mm hoch
 Streuwert: 3.82, horizontal: 4.33, vertikal: 3.23

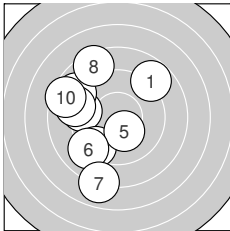
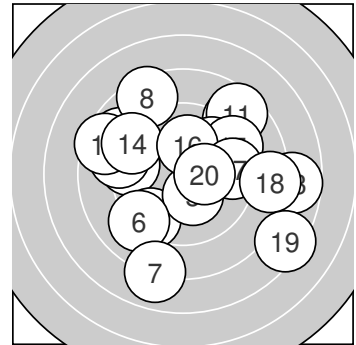

Serie 1: 89.5 (86)

8.8 ↗ 9.3 ← 9.3 ↘
 9.1 ↙ 8.0 ↓ 8.4 ↖

8.8 ↖ 10.3* ↓
 9.0 ← 8.5 ↖

beste Teiler: 169.9 (5.), 401.7 (2.), 404.4 (3.)
 Trefferlage: 2.48 mm links, 0.10 mm hoch
 Streuwert: 3.42, horizontal: 2.82, vertikal: 3.93

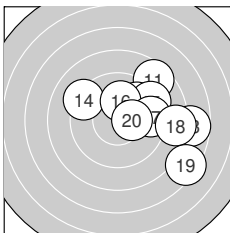

Serie 2: 90.2 (86)

8.6 ↗ 9.8 ↗ 7.7 →
 10.1 ↑ 9.5 → 8.4 →

9.2 ↖ 9.3 ↗
 7.3 ↘ 10.3* →

beste Teiler: 159.0 (20.), 213.5 (16.), 290.1 (12.)
 Trefferlage: 3.35 mm rechts, 0.70 mm hoch
 Streuwert: 3.09, horizontal: 3.56, vertikal: 2.54

