

Ergebnis: **177.3** (167)  
 Serien: 86.5 90.8  
 Zähler: 2 5 12 0 1 0 0 0 0 0 0  
 Innenzehner: 1  
 Weitester: 1104 (8.), 707 (10.), 683 (6.)  
 beste Teiler: 97.3 (15.), 241.2 (7.), 278.6 (4.)  
 Trefferlage: 1.11 mm links, 0.08 mm hoch  
 Streuwert: 3.97, horizontal: 3.87, vertikal: 4.06

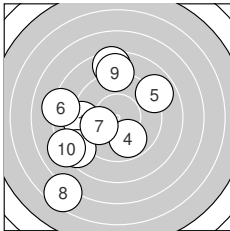
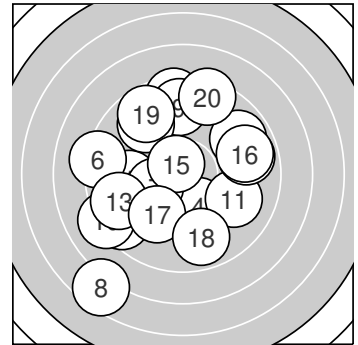

**Serie 1: 86.5 (82)**

9.2 ←	8.5 ↑	8.5 ↙	9.8 ↓	8.9 ↗
8.2 ←	10.0 ↙	6.5 ↘	8.8 ↑	8.1 ↖

beste Teiler: 241.2 (7.), 278.6 (4.), 426.6 (1.)  
 Trefferlage: 2.60 mm links, 0.47 mm tief  
 Streuwert: 4.16, horizontal: 3.71, vertikal: 4.56

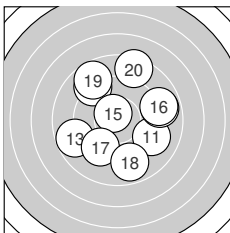

**Serie 2: 90.8 (85)**

9.2 ↘	8.9 →	8.8 ↙	9.0 ↖	10.6* ↘
8.9 →	9.4 ↘	8.9 ↓	8.7 ↖	8.4 ↑

beste Teiler: 97.3 (15.), 378.3 (17.), 446.7 (11.)  
 Trefferlage: 0.37 mm rechts, 0.64 mm hoch  
 Streuwert: 3.63, horizontal: 3.60, vertikal: 3.65



Ergebnis: **198.4** (189)  
 Serien: 100.5 97.9  
 Zähler: 12 6 1 1 0 0 0 0 0 0  
 Innenzehner: 10  
 Weitesten: 781 (20.), 614 (5.), 480 (10.)  
 beste Teiler: 35.2 (13.), 39.5 (14.), 61.2 (11.)  
 Trefferlage: 0.68 mm rechts, 0.14 mm hoch  
 Streuwert: 2.30, horizontal: 3.04, vertikal: 1.16

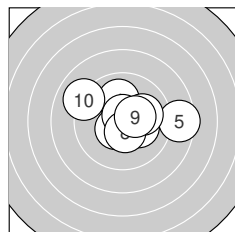
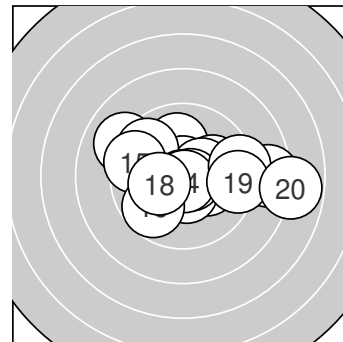

**Serie 1: 100.5 (97)**

10.2* ↘	10.6* →	10.5* ↙	10.0 ↑	8.5 →
10.7* ↑	10.1 →	10.5* ↓	10.4* →	9.0 ↖

beste Teiler: 65.0 (6.), 92.9 (2.), 110.3 (3.)  
 Trefferlage: 0.71 mm rechts, 0.42 mm hoch  
 Streuwert: 2.03, horizontal: 2.61, vertikal: 1.19

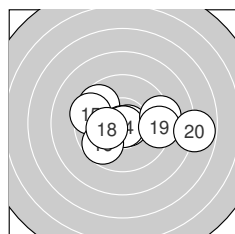

**Serie 2: 97.9 (92)**

10.7* ↘	9.7 ↖	10.8* ↓	10.8* ↓	9.5 ↖
9.7 ↙	9.3 →	10.2* ←	9.4 →	7.8 →

beste Teiler: 35.2 (13.), 39.5 (14.), 61.2 (11.)  
 Trefferlage: 0.65 mm rechts, 0.13 mm tief  
 Streuwert: 2.65, horizontal: 3.57, vertikal: 1.12



Ergebnis: **204.3** (195)  
 Serien: 103.8 100.5  
 Zähler: 16 3 1 0 0 0 0 0 0 0  
 Innenzehner: 14  
 Weitester: 671 (16.), 320 (13.), 300 (2.)  
 beste Teiler: 34.0 (5.), 64.2 (12.), 65.0 (15.)  
 Trefferlage: 0.41 mm rechts, 0.27 mm hoch  
 Streuwert: 1.63, horizontal: 1.98, vertikal: 1.17

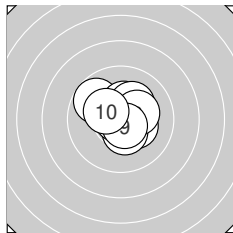
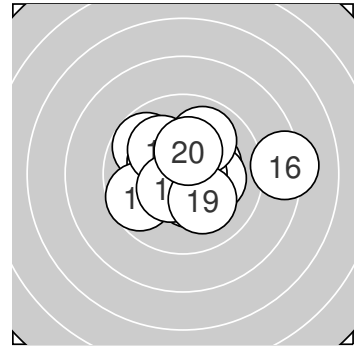

**Serie 1: 103.8 (99)**

10.3* ↘	9.8 ↘	10.7* ↘	10.4* ↓	10.8* ←
10.3* ↑	10.2* ↗	10.3* →	10.7* ↓	10.3* ↘

beste Teiler: 34.0 (5.), 73.1 (3.), 75.4 (9.)  
 Trefferlage: 0.06 mm rechts, 0.41 mm hoch  
 Streuwert: 1.16, horizontal: 1.27, vertikal: 1.04

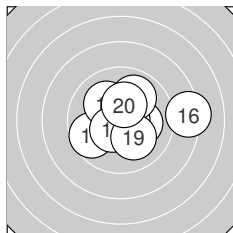

**Serie 2: 100.5 (96)**

10.2* →	10.7* ↘	9.7 ←	10.1 ↘	10.7* →
8.3 →	10.5* ↘	9.9 ↗	10.1 ↓	10.3* ↑

beste Teiler: 64.2 (12.), 65.0 (15.), 121.8 (17.)  
 Trefferlage: 0.77 mm rechts, 0.13 mm hoch  
 Streuwert: 2.02, horizontal: 2.52, vertikal: 1.33



**Ergebnis: 198.3 (189)**  
**Serien: 99.8 98.5**  
**Zähler: 12 7 0 0 1 0 0 0 0 0 0**  
**Innenzehner: 8**  
**Weiteste: 1006 (15.), 446 (5.), 360 (6.)**  
**beste Teiler: 15.0 (17.), 55.0 (1.), 101.4 (13.)**  
**Trefferlage: 0.15 mm rechts, 0.64 mm hoch**  
**Streuwert: 2.33, horizontal: 2.89, vertikal: 1.58**

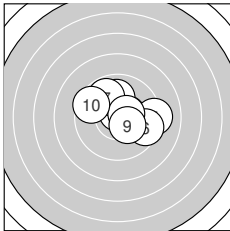
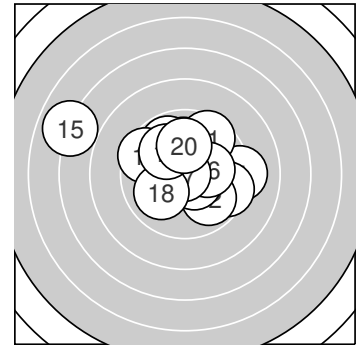

**Serie 1: 99.8 (95)**

10.7\* ↑      10.5\* →      10.0 ↑      9.8 →      9.2 →  
 9.5 →      9.8 ↘      10.5\* →      10.3\* ↘      9.5 ↘  
**beste Teiler: 55.0 (1.), 113.6 (8.), 121.7 (2.)**  
**Trefferlage: 0.91 mm rechts, 0.48 mm hoch**  
**Streuwert: 1.85, horizontal: 2.27, vertikal: 1.31**

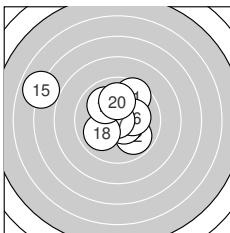

**Serie 2: 98.5 (94)**

9.6 ↗      9.9 ↘      10.5\* ↘      10.5\* ↗      6.9 ↖  
 10.2\* →      10.9\* ←      10.0 ↙      10.0 ↘      10.0 ↑  
**beste Teiler: 15.0 (17.), 101.4 (13.), 104.8 (14.)**  
**Trefferlage: 0.60 mm links, 0.79 mm hoch**  
**Streuwert: 2.72, horizontal: 3.35, vertikal: 1.88**



Ergebnis: **207.4** (199)  
 Serien: 103.2 104.2  
 Zähler: 19 1 0 0 0 0 0 0 0 0 0  
 Innenzehner: 16  
 Weitesten: 293 (4.), 244 (3.), 235 (13.)  
 beste Teiler: 54.2 (14.), 80.2 (15.), 83.4 (2.)  
 Trefferlage: 0.35 mm links, 0.47 mm tief  
 Streuwert: 1.08, horizontal: 1.12, vertikal: 1.03

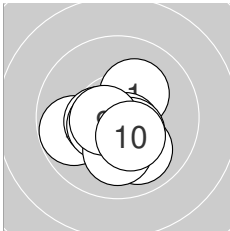
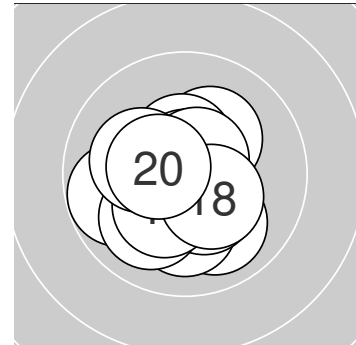

**Serie 1: 103.2 (99)**

10.2* ↗	10.6* ↘	10.0 ↘	9.8 ←	10.5* ↘
10.5* ←	10.5* ↙	10.1 ↓	10.6* ←	10.4* ↘

beste Teiler: 83.4 (2.), 88.2 (9.), 114.9 (7.)  
 Trefferlage: 0.14 mm links, 0.74 mm tief  
 Streuwert: 1.18, horizontal: 1.31, vertikal: 1.04

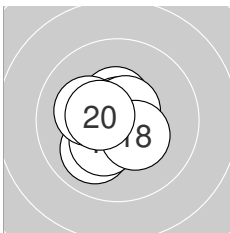

**Serie 2: 104.2 (100)**

10.5* ↑	10.5* ↙	10.0 ↘	10.7* ↑	10.6* ↗
10.5* ↙	10.3* ↘	10.4* ↘	10.2* ←	10.5* ←

beste Teiler: 54.2 (14.), 80.2 (15.), 101.6 (16.)  
 Trefferlage: 0.56 mm links, 0.21 mm tief  
 Streuwert: 0.97, horizontal: 0.93, vertikal: 1.00



Ergebnis: **198.3** (190)  
 Serien: 99.9 98.4  
 Zähler: 12 7 0 1 0 0 0 0 0 0  
 Innenzehner: 9  
 Weitestе: 806 (12.), 485 (15.), 431 (17.)  
 beste Teiler: 55.9 (10.), 60.5 (3.), 61.5 (20.)  
 Trefferlage: 0.68 mm links, 0.16 mm tief  
 Streuwert: 2.22, horizontal: 2.65, vertikal: 1.70

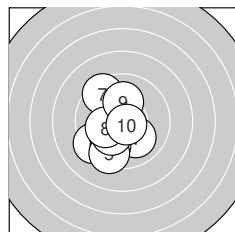
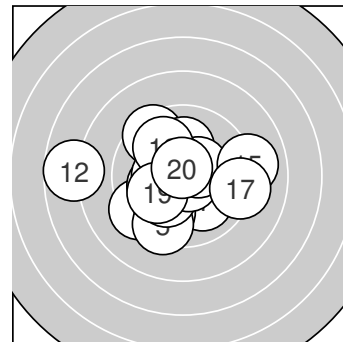

**Serie 1: 99.9 (96)**

10.0 ↘	9.3 ↙	10.7* ↑	9.8 ↙	9.4 ↙
10.2* ↙	9.5 ↘	10.2* ←	10.1 ↑	10.7* ↘

beste Teiler: 55.9 (10.), 60.5 (3.), 193.4 (6.)  
 Trefferlage: 0.94 mm links, 0.72 mm tief  
 Streuwert: 1.79, horizontal: 1.40, vertikal: 2.12

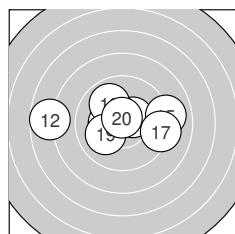

**Serie 2: 98.4 (94)**

10.5* ↘	7.7 ←	10.3* ←	10.4* ↗	9.0 →
10.6* ↘	9.2 →	9.9 ↘	10.1 ↙	10.7* ↑

beste Teiler: 61.5 (20.), 93.5 (16.), 101.1 (11.)  
 Trefferlage: 0.42 mm links, 0.39 mm hoch  
 Streuwert: 2.60, horizontal: 3.56, vertikal: 0.94



Ergebnis: **198.1** (186)  
 Serien: 97.8 100.3  
 Zähler: 9 9 1 1 0 0 0 0 0 0 0  
 Innenzehner: 8  
 Weitesten: 805 (5.), 543 (3.), 335 (18.)  
 beste Teiler: 87.5 (8.), 89.8 (2.), 90.0 (13.)  
 Trefferlage: 0.63 mm links, 0.09 mm tief  
 Streuwert: 2.21, horizontal: 3.00, vertikal: 0.87

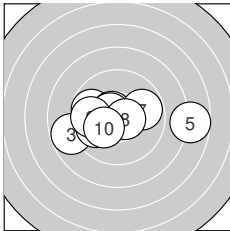
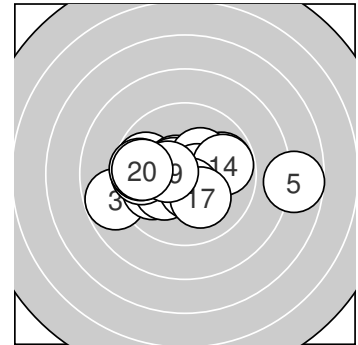

**Serie 1: 97.8 (91)**

9.8 ←	10.6* ↖	8.8 ←	10.6* ↖	7.7 →
9.9 ←	9.8 →	10.6* →	9.8 ←	10.2* ↙

beste Teiler: 87.5 (8.), 89.8 (2.), 93.0 (4.)  
 Trefferlage: 0.47 mm links, 0.21 mm tief  
 Streuwert: 2.69, horizontal: 3.69, vertikal: 0.93

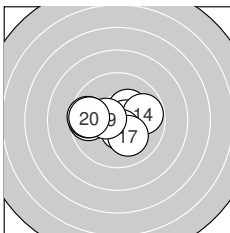

**Serie 2: 100.3 (95)**

9.7 ←	10.3* ↗	10.6* →	9.8 →	9.6 ←
10.5* ↓	10.1 ↓	9.6 ←	10.4* ←	9.7 ←

beste Teiler: 90.0 (13.), 109.7 (16.), 127.2 (19.)  
 Trefferlage: 0.79 mm links, 0.02 mm hoch  
 Streuwert: 1.74, horizontal: 2.32, vertikal: 0.83



Ergebnis: **200.8** (193)  
 Serien: 99.9 100.9  
 Zähler: 14 5 1 0 0 0 0 0 0 0  
 Innenzehner: 10  
 Weitestе: 609 (9.), 460 (17.), 359 (10.)  
 beste Teiler: 83.0 (2.), 88.5 (8.), 116.7 (11.)  
 Trefferlage: 0.98 mm links, 0.06 mm hoch  
 Streuwert: 1.75, horizontal: 2.17, vertikal: 1.18

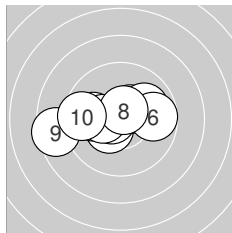
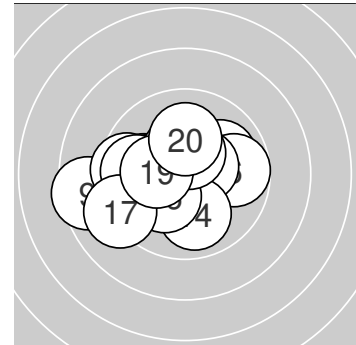

**Serie 1: 99.9 (95)**

10.4\* ↙      10.6\* ←      10.4\* ↗  
 9.7 →      10.3\* ←      10.6\* ↑  
 beste Teiler: 83.0 (2.), 88.5 (8.), 126.6 (3.)  
 Trefferlage: 0.92 mm links, 0.15 mm hoch  
 Streuwert: 1.98, horizontal: 2.70, vertikal: 0.74

10.0 ↗      9.9 ←  
 8.5 ←      9.5 ←

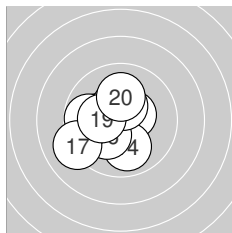

**Serie 2: 100.9 (98)**

10.5\* ↗      10.1 ←      9.8 ←  
 10.2\* ↙      9.1 ↙      10.4\* ↑  
 beste Teiler: 116.7 (11.), 133.5 (18.), 135.3 (15.)  
 Trefferlage: 1.04 mm links, 0.03 mm tief  
 Streuwert: 1.59, horizontal: 1.64, vertikal: 1.54

10.0 ↓      10.4\* ↖  
 10.3\* ←      10.1 ↑





Ergebnis: **184.7** (178)  
 Serien: 99.3 85.4  
 Zähler: 10 6 1 1 0 1 1 0 0 0 0  
 Innenzehner: 7  
 Weitester: 1692 (20.), 1465 (17.), 999 (14.)  
 beste Teiler: 138.0 (9.), 143.5 (2.), 151.2 (8.)  
 Trefferlage: 1.89 mm rechts, 0.72 mm hoch  
 Streuwert: 4.15, horizontal: 5.70, vertikal: 1.41

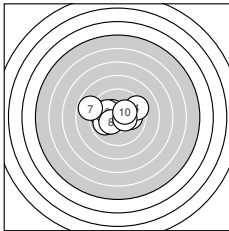
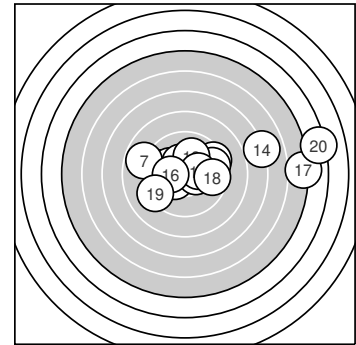

**Serie 1: 99.3 (95)**

10.0 →	10.4* ↖	9.7 ←	9.4 →	9.9 ←
10.1 ↖	8.8 ↖	10.3* ↙	10.4* →	10.3* ↗

beste Teiler: 138.0 (9.), 143.5 (2.), 151.2 (8.)  
 Trefferlage: 0.60 mm links, 0.49 mm hoch  
 Streuwert: 2.02, horizontal: 2.67, vertikal: 0.99

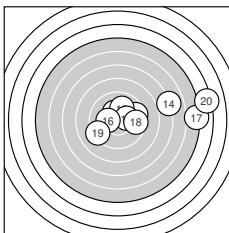

**Serie 2: 85.4 (83)**

9.5 →	10.3* ↖	10.0 ↑	7.0 →	10.3* →
10.2* ←	5.1 →	9.6 →	9.2 ↙	4.2 →

beste Teiler: 156.5 (12.), 169.0 (15.), 178.0 (16.)  
 Trefferlage: 4.38 mm rechts, 0.95 mm hoch  
 Streuwert: 5.04, horizontal: 6.91, vertikal: 1.75



Ergebnis: **191.4** (182)  
 Serien: 93.9 97.5  
 Zähler: 5 12 3 0 0 0 0 0 0 0  
 Innenzehner: 5  
 Weitester: 627 (12.), 540 (1.), 531 (10.)  
 beste Teiler: 47.5 (17.), 149.3 (13.), 169.2 (20.)  
 Trefferlage: 1.12 mm rechts, 0.75 mm tief  
 Streuwert: 2.55, horizontal: 2.96, vertikal: 2.07

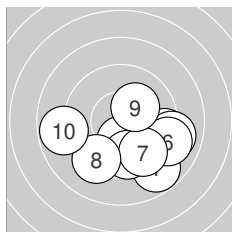
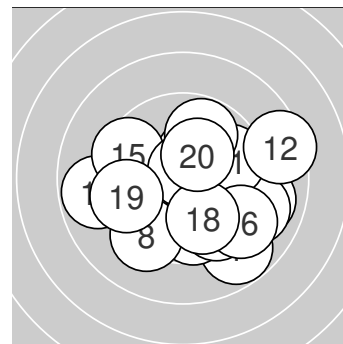

**Serie 1: 93.9 (90)**

8.8 ↘	9.3 →	9.0 →	10.2* ↓	9.7 ↓
9.1 →	9.5 ↘	9.3 ↙	10.2* ↗	8.8 ←

beste Teiler: 176.0 (4.), 187.4 (9.), 316.5 (5.)  
 Trefferlage: 1.30 mm rechts, 1.93 mm tief  
 Streuwert: 2.51, horizontal: 3.17, vertikal: 1.60

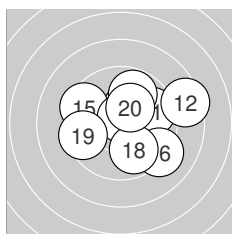

**Serie 2: 97.5 (92)**

9.7 →	8.4 →	10.4* ↑	9.8 ↑	9.5 ↖
9.2 ↘	10.8* ↑	9.9 ↘	9.5 ←	10.3* ↗

beste Teiler: 47.5 (17.), 149.3 (13.), 169.2 (20.)  
 Trefferlage: 0.94 mm rechts, 0.41 mm hoch  
 Streuwert: 2.43, horizontal: 2.89, vertikal: 1.85



Ergebnis: **168.1** (157)  
 Serien: 81.1 87.0  
 Zähler: 3 4 8 2 0 2 0 1 0 0 0  
 Innenzehner: 2  
 Weitester: 1811 (10.), 1340 (4.), 1275 (12.)  
 beste Teiler: 70.2 (11.), 134.5 (20.), 246.1 (8.)  
 Trefferlage: 1.20 mm links, 2.07 mm tief  
 Streuwert: 5.27, horizontal: 5.74, vertikal: 4.75

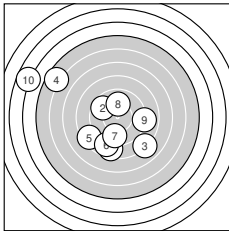
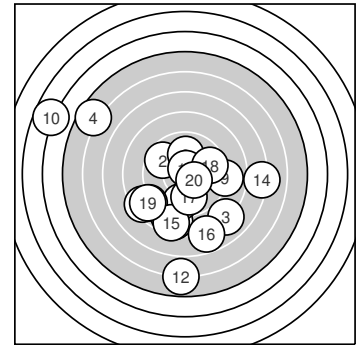

**Serie 1: 81.1 (76)**

8.5 ↓      9.6 ↖      8.0 ↘  
 8.8 ↙      9.6 ↓      10.0 ↑

5.6 ↖      8.4 ↙  
 8.9 →      3.7 ↖

beste Teiler: 246.1 (8.), 326.2 (2.), 348.2 (7.)  
 Trefferlage: 2.98 mm links, 0.56 mm tief  
 Streuwert: 5.93, horizontal: 6.77, vertikal: 4.95

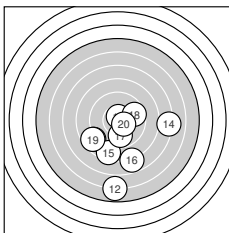

**Serie 2: 87.0 (81)**

10.7\* ↑      5.9 ↓      8.7 ↙  
 7.8 ↓      9.8 ↓      9.6 →

7.1 →      8.4 ↓  
 8.6 ↙      10.4\* ↘

beste Teiler: 70.2 (11.), 134.5 (20.), 287.3 (17.)  
 Trefferlage: 0.58 mm rechts, 3.58 mm tief  
 Streuwert: 4.17, horizontal: 4.10, vertikal: 4.25



Ergebnis: **191.6** (181)  
 Serien: 96.2 95.4  
 Zähler: 6 9 5 0 0 0 0 0 0 0 0  
 Innenzehner: 5  
 Weitesten: 672 (18.), 586 (14.), 545 (9.)  
 beste Teiler: 63.5 (15.), 114.1 (6.), 139.9 (7.)  
 Trefferlage: 0.05 mm rechts, 1.00 mm hoch  
 Streuwert: 2.68, horizontal: 3.15, vertikal: 2.10

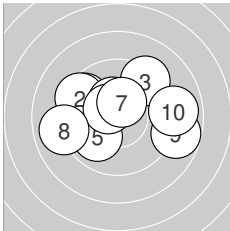
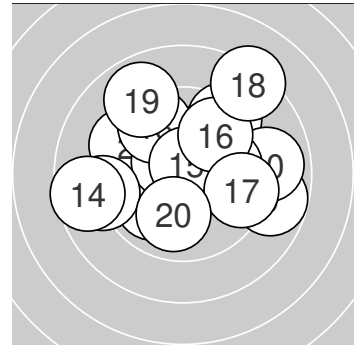

**Serie 1: 96.2 (91)**

9.6 ↘ 9.4 ↘ 9.3 ↗  
 10.5\* ↘ 10.4\* ↑ 9.0 ←  
 beste Teiler: 114.1 (6.), 139.9 (7.), 145.1 (4.)  
 Trefferlage: 0.12 mm links, 0.64 mm hoch  
 Streuwert: 2.70, horizontal: 3.46, vertikal: 1.62

10.4\* ↖ 9.9 ↙  
 8.8 → 8.9 →

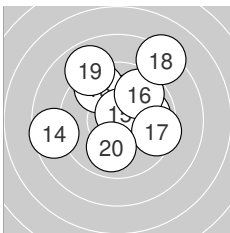

**Serie 2: 95.4 (90)**

10.2\* ↑ 9.9 → 9.6 ↘  
 9.7 ↗ 9.5 → 8.3 ↗  
 beste Teiler: 63.5 (15.), 196.8 (11.), 247.6 (20.)  
 Trefferlage: 0.23 mm rechts, 1.35 mm hoch  
 Streuwert: 2.77, horizontal: 2.99, vertikal: 2.53

8.6 ← 10.7\* ↑  
 8.9 ↘ 10.0 ↓



Ergebnis: **187.1** (176)  
 Serien: 94.7 92.4  
 Zähler: 4 10 4 2 0 0 0 0 0 0 0  
 Innenzehner: 3  
 Weitester: 866 (1.), 797 (12.), 702 (9.)  
 beste Teiler: 109.0 (14.), 149.0 (19.), 175.6 (8.)  
 Trefferlage: 0.72 mm links, 1.32 mm hoch  
 Streuwert: 3.09, horizontal: 3.09, vertikal: 3.10

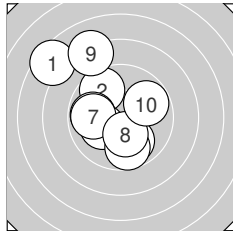
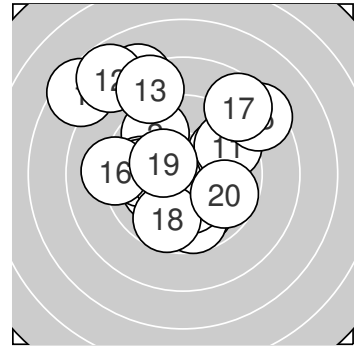

**Serie 1: 94.7 (89)**

7.5 ↖	9.6 ↖	9.8 ←	9.9 ↓	10.1 ↙
9.7 ↓	9.9 ←	10.3* ↓	8.1 ↖	9.8 ↗

beste Teiler: 175.6 (8.), 203.5 (5.), 258.5 (4.)  
 Trefferlage: 1.40 mm links, 0.82 mm hoch  
 Streuwert: 2.94, horizontal: 2.69, vertikal: 3.17

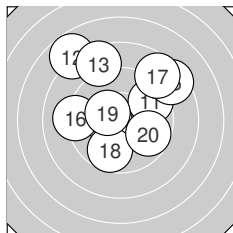

**Serie 2: 92.4 (87)**

9.5 ↗	7.8 ↖	8.5 ↖	10.5* ↙	8.4 ↗
9.2 ←	8.7 ↗	9.7 ↓	10.4* ↖	9.7 ↘

beste Teiler: 109.0 (14.), 149.0 (19.), 305.0 (20.)  
 Trefferlage: 0.04 mm links, 1.83 mm hoch  
 Streuwert: 3.28, horizontal: 3.45, vertikal: 3.11



Ergebnis: **181.4** (174)  
 Serien: 88.7 92.7  
 Zähler: 4 11 2 2 0 1 0 0 0 0 0  
 Innenzehner: 3  
 Weitester: 1492 (6.), 919 (3.), 861 (18.)  
 beste Teiler: 128.4 (14.), 184.8 (17.), 189.4 (2.)  
 Trefferlage: 1.11 mm rechts, 0.06 mm tief  
 Streuwert: 4.02, horizontal: 4.87, vertikal: 2.93

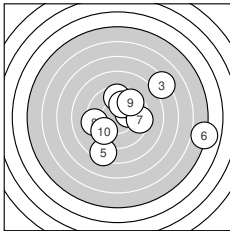
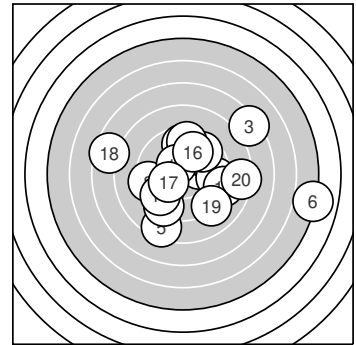

**Serie 1: 88.7 (85)**

9.6 ↑	10.2* →	7.3 ↗	10.0 ↑	8.4 ↓
5.0 →	9.5 →	9.4 ←	9.6 ↗	9.7 ↘

beste Teiler: 189.4 (2.), 228.9 (4.), 323.8 (10.)  
 Trefferlage: 2.18 mm rechts, 0.14 mm hoch  
 Streuwert: 4.55, horizontal: 5.48, vertikal: 3.37

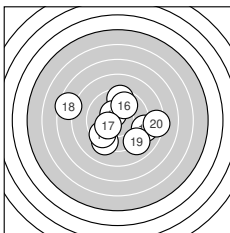

**Serie 2: 92.7 (89)**

9.3 ↘	9.0 →	9.5 ↑	10.4* ↘	9.6 ↘
9.9 ↑	10.2* ↙	7.5 ←	9.0 ↘	8.3 →

beste Teiler: 128.4 (14.), 184.8 (17.), 274.8 (16.)  
 Trefferlage: 0.05 mm rechts, 0.28 mm tief  
 Streuwert: 3.48, horizontal: 4.19, vertikal: 2.58



Ergebnis: **183.3** (176)  
 Serien: 88.7 94.6  
 Zähler: 6 8 2 4 0 0 0 0 0 0 0  
 Innenzehner: 4  
 Weitester: 986 (10.), 920 (17.), 904 (5.)  
 beste Teiler: 21.4 (7.), 38.9 (11.), 107.6 (8.)  
 Trefferlage: 1.53 mm links, 1.29 mm hoch  
 Streuwert: 3.54, horizontal: 4.57, vertikal: 2.05

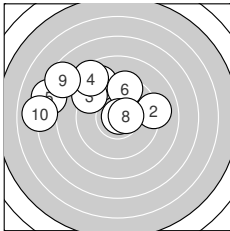
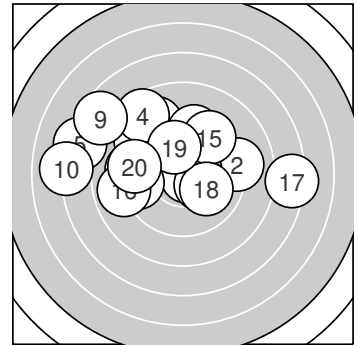

**Serie 1: 88.7 (85)**

9.0 ↘                      9.1 →                      9.2 ↘                      8.6 ↘                      7.3 ←  
 9.5 ↑                      10.9\* ↗                      10.5\* →                      7.6 ↘                      7.0 ←

beste Teiler: 21.4 (7.), 107.6 (8.), 371.8 (6.)  
 Trefferlage: 2.79 mm links, 2.44 mm hoch  
 Streuwert: 3.56, horizontal: 4.65, vertikal: 1.93

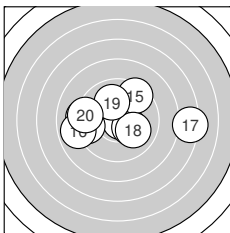

**Serie 2: 94.6 (91)**

10.8\* ↘                      9.2 ←                      9.4 ←                      10.3\* ↘                      9.4 ↗  
 8.9 ←                      7.3 →                      10.0 ↘                      10.0 ↑                      9.3 ←

beste Teiler: 38.9 (11.), 173.9 (14.), 233.3 (18.)  
 Trefferlage: 0.27 mm links, 0.14 mm hoch  
 Streuwert: 3.25, horizontal: 4.35, vertikal: 1.50



Ergebnis: **182.0** (175)  
 Serien: 90.7 91.3  
 Zähler: 6 6 6 1 1 0 0 0 0 0 0  
 Innenzehner: 5  
 Weitester: 1002 (6.), 939 (20.), 653 (1.)  
 beste Teiler: 124.9 (4.), 147.9 (18.), 165.7 (14.)  
 Trefferlage: 0.63 mm links, 1.19 mm hoch  
 Streuwert: 3.69, horizontal: 4.67, vertikal: 2.32

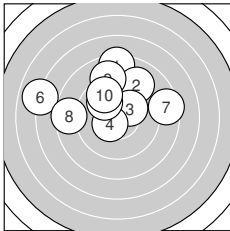
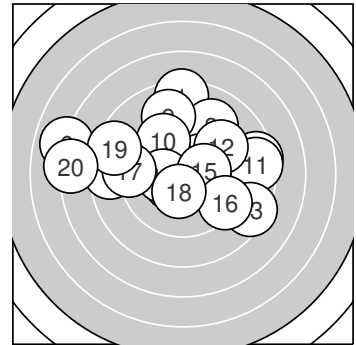

**Serie 1: 90.7 (87)**

8.3 ↑	9.1 ↗	10.2* ↗	10.5* ↖	10.0 ↖
6.9 ←	8.5 →	8.5 ←	9.0 ↑	9.7 ↖

beste Teiler: 124.9 (4.), 190.2 (3.), 248.8 (5.)  
 Trefferlage: 1.13 mm links, 2.43 mm hoch  
 Streuwert: 3.46, horizontal: 4.36, vertikal: 2.21

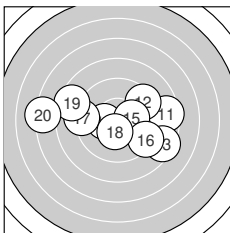

**Serie 2: 91.3 (88)**

8.5 →	9.4 ↗	8.4 ↘	10.3* ←	10.2* →
9.3 ↘	9.1 ←	10.4* ↓	8.5 ↖	7.2 ←

beste Teiler: 147.9 (18.), 165.7 (14.), 178.3 (15.)  
 Trefferlage: 0.14 mm links, 0.04 mm tief  
 Streuwert: 3.84, horizontal: 5.14, vertikal: 1.75





Ergebnis: **192.5** (185)  
 Serien: 96.5 96.0  
 Zähler: 7 11 2 0 0 0 0 0 0 0  
 Innenzehner: 4  
 Weitestе: 689 (12.), 635 (6.), 479 (10.)  
 beste Teiler: 78.2 (15.), 134.7 (2.), 135.0 (19.)  
 Trefferlage: 0.63 mm rechts, 0.25 mm hoch  
 Streuwert: 2.60, horizontal: 3.04, vertikal: 2.07

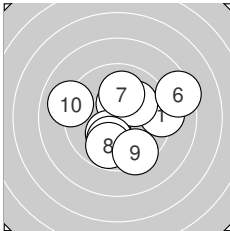
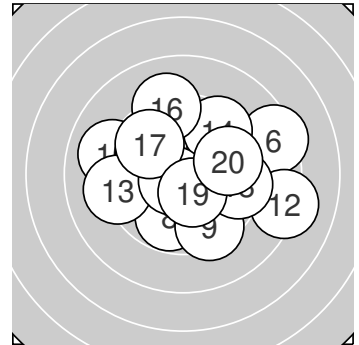

**Serie 1: 96.5 (94)**

9.2 → 10.4\* ↑ 10.2\* ↘  
 8.4 → 10.0 ↑ 9.8 ↘  
 beste Teiler: 134.7 (2.), 182.3 (3.), 214.8 (4.)  
 Trefferlage: 0.70 mm rechts, 0.10 mm tief  
 Streuwert: 2.59, horizontal: 2.95, vertikal: 2.16

10.1 ↗ 10.0 ↓  
 9.4 ↘ 9.0 ←

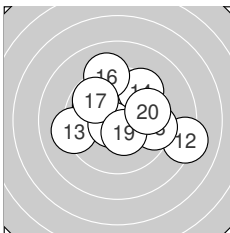

**Serie 2: 96.0 (91)**

9.9 ↖ 8.2 → 9.2 ←  
 9.2 ↑ 9.8 ↖ 9.5 →  
 beste Teiler: 78.2 (15.), 135.0 (19.), 259.6 (11.)  
 Trefferlage: 0.57 mm rechts, 0.61 mm hoch  
 Streuwert: 2.72, horizontal: 3.28, vertikal: 2.02

9.5 ↗ 10.6\* ↖  
 10.4\* ↘ 9.7 →



Ergebnis: **177.3** (170)  
 Serien: 87.1 90.2  
 Zähler: 5 6 5 2 2 0 0 0 0 0 0  
 Innenzehner: 1  
 Weitester: 1180 (12.), 1073 (5.), 889 (11.)  
 beste Teiler: 183.3 (8.), 209.0 (19.), 222.1 (15.)  
 Trefferlage: 0.91 mm rechts, 0.91 mm hoch  
 Streuwert: 4.28, horizontal: 5.55, vertikal: 2.40

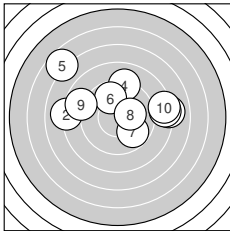
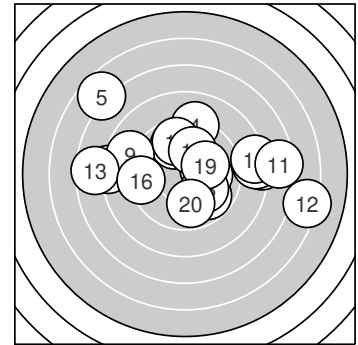

**Serie 1: 87.1 (83)**

8.0 →                      8.1 ←                      8.3 →                      9.1 ↑                      6.7 ↖  
 9.8 ↗                      9.8 ↘                      10.2\* →                      8.8 ←                      8.3 →

beste Teiler: 183.3 (8.), 290.7 (6.), 293.5 (7.)  
 Trefferlage: 0.41 mm rechts, 1.83 mm hoch  
 Streuwert: 4.39, horizontal: 5.66, vertikal: 2.57

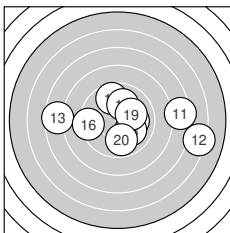

**Serie 2: 90.2 (87)**

7.4 →                      6.2 →                      7.6 ←                      9.7 ↑                      10.1 →  
 9.3 ←                      10.0 ↑                      10.0 ↘                      10.1 →                      9.8 ↓

beste Teiler: 209.0 (19.), 222.1 (15.), 229.4 (18.)  
 Trefferlage: 1.41 mm rechts, 0.01 mm tief  
 Streuwert: 4.25, horizontal: 5.69, vertikal: 1.92



Ergebnis: **190.0** (181)  
 Serien: 95.8 94.2  
 Zähler: 8 6 5 1 0 0 0 0 0 0 0  
 Innenzehner: 7  
 Weitester: 868 (12.), 711 (9.), 632 (11.)  
 beste Teiler: 9.0 (18.), 97.0 (7.), 106.8 (17.)  
 Trefferlage: 0.22 mm links, 1.56 mm hoch  
 Streuwert: 2.90, horizontal: 3.30, vertikal: 2.43

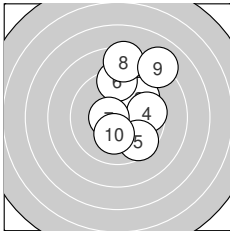
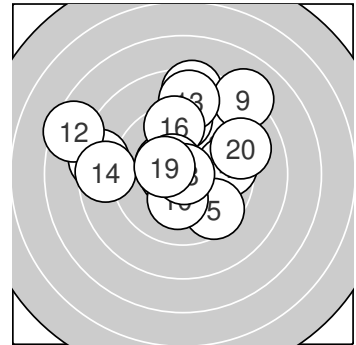

**Serie 1: 95.8 (92)**

10.2\* ↗ 10.1 ↘ 9.6 ↗  
 9.3 ↑ 10.6\* ← 8.5 ↑  
 beste Teiler: 97.0 (7.), 185.2 (1.), 188.0 (10.)  
 Trefferlage: 1.48 mm rechts, 1.40 mm hoch  
 Streuwert: 2.47, horizontal: 1.71, vertikal: 3.05

9.6 → 9.6 ↘  
 8.1 ↗ 10.2\* ↓

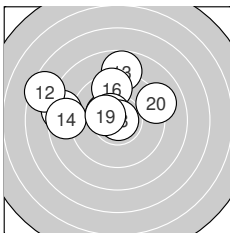

**Serie 2: 94.2 (89)**

8.4 ← 7.5 ↖ 8.8 ↑  
 9.5 ↑ 10.5\* ↖ 10.9\* →  
 beste Teiler: 9.0 (18.), 106.8 (17.), 146.3 (19.)  
 Trefferlage: 1.93 mm links, 1.73 mm hoch  
 Streuwert: 2.90, horizontal: 3.70, vertikal: 1.77

8.7 ← 10.4\* ↖  
 10.4\* ↖ 9.1 →



Ergebnis: **182.9** (173)  
 Serien: 95.1 87.8  
 Zähler: 5 6 6 3 0 0 0 0 0 0 0  
 Innenzehner: 3  
 Weitester: 985 (7.), 832 (17.), 795 (18.)  
 beste Teiler: 93.4 (9.), 121.0 (12.), 197.3 (8.)  
 Trefferlage: 0.09 mm links, 1.64 mm tief  
 Streuwert: 3.55, horizontal: 3.91, vertikal: 3.16

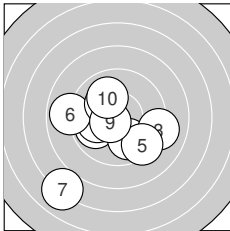
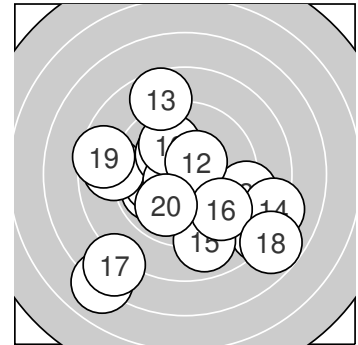

**Serie 1: 95.1 (91)**

9.9 ↙	9.9 ↘	9.1 →	10.1 ←	9.4 ↘
8.9 ←	7.0 ↙	10.2* ↘	10.6* ↙	10.0 ↗

beste Teiler: 93.4 (9.), 197.3 (8.), 225.8 (4.)  
 Trefferlage: 1.07 mm links, 1.27 mm tief  
 Streuwert: 3.01, horizontal: 3.22, vertikal: 2.78

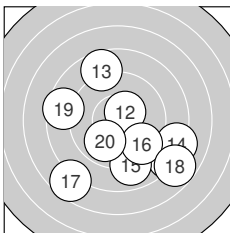

**Serie 2: 87.8 (82)**

8.2 ↘	10.5* ↗	8.7 ↑	8.2 →	8.9 ↘
9.5 ↘	7.6 ↙	7.8 ↘	8.5 ←	9.9 ↙

beste Teiler: 121.0 (12.), 262.5 (20.), 365.6 (16.)  
 Trefferlage: 0.88 mm rechts, 2.02 mm tief  
 Streuwert: 4.05, horizontal: 4.44, vertikal: 3.60



# LG 40 ZR

StandNr: 127

Lagner, Lukas #773

# Jungschützen

Wertung

StartNr: 77

11.02.2024 11:44

SG\_Fieberbrunn

Ergebnis: **395.1** (378)  
 Serien: 96.3 97.0 102.3 99.5  
 Zähler: 22 14 4 0 0 0 0 0 0 0  
 Innenzehner: 19  
 Weitester: 677 (7.), 623 (3.), 573 (12.)  
 beste Teiler: 30.1 (37.), 49.2 (36.), 79.0 (22.)  
 Trefferlage: 0.10 mm rechts, 0.81 mm hoch  
 Streuwert: 2.18, horizontal: 2.62, vertikal: 1.63

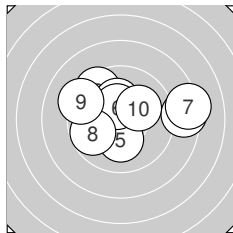
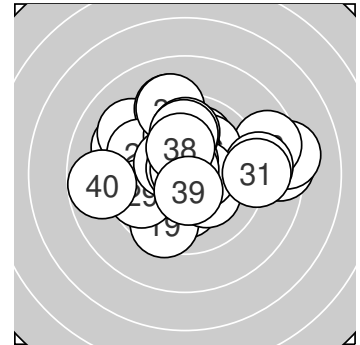

### Serie 1: 96.3 (93)

10.3* ←	9.5 ↘	8.5 →	10.2* ↑	10.2* ↓
10.4* ↑	8.2 →	9.7 ←	9.2 ↖	10.1 ↗

beste Teiler: 128.8 (6.), 159.3 (1.), 181.2 (4.)  
 Trefferlage: 0.34 mm rechts, 0.71 mm hoch  
 Streuwert: 2.74, horizontal: 3.58, vertikal: 1.48

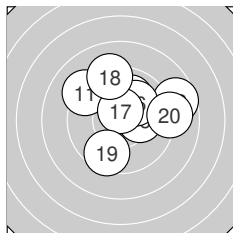

### Serie 2: 97.0 (94)

9.2 ↘	8.7 →	10.4* ↗	10.0 ↗	10.2* →
10.1 ↗	10.6* ↑	9.2 ↑	9.6 ↘	9.0 →

beste Teiler: 94.0 (17.), 146.6 (13.), 189.0 (15.)  
 Trefferlage: 0.94 mm rechts, 1.22 mm hoch  
 Streuwert: 2.37, horizontal: 2.71, vertikal: 1.97

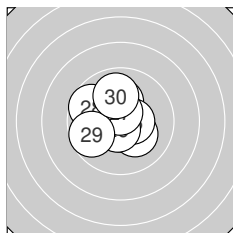

### Serie 3: 102.3 (97)

10.2* ↑	10.6* ↓	10.3* ←	10.2* ↘	10.5* →
10.6* ↘	10.6* ↑	9.7 ↖	9.7 ←	9.9 ↑

beste Teiler: 79.0 (22.), 85.4 (26.), 87.2 (27.)  
 Trefferlage: 0.54 mm links, 0.19 mm hoch  
 Streuwert: 1.41, horizontal: 1.46, vertikal: 1.37

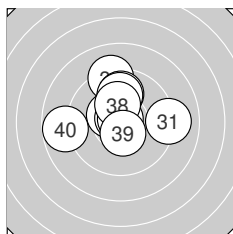

### Serie 4: 99.5 (94)

9.1 →	9.2 ↑	10.4* ↘	9.8 ↑	9.9 ↑
10.8* ↘	10.8* ↑	10.2* ↑	10.5* ↓	8.8 ←

beste Teiler: 30.1 (37.), 49.2 (36.), 111.4 (39.)  
 Trefferlage: 0.32 mm links, 1.11 mm hoch  
 Streuwert: 2.10, horizontal: 2.42, vertikal: 1.71



**Ergebnis: 374.1 (357)**  
**Serien: 91.7 94.8 91.9 95.7**  
**Zähler: 11 18 8 3 0 0 0 0 0 0 0**  
**Innenzehner: 10**  
**Weiteste: 926 (30.), 923 (40.), 756 (17.)**  
**beste Teiler: 28.0 (31.), 47.0 (37.), 99.8 (27.)**  
**Trefferlage: 1.29 mm links, 0.53 mm hoch**  
**Streuwert: 3.09, horizontal: 3.32, vertikal: 2.85**

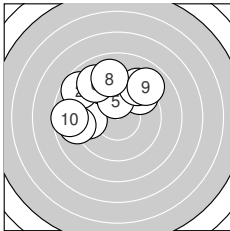
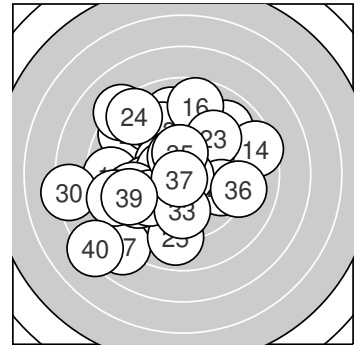

**Serie 1: 91.7 (89)**

9.6 ←	8.7 ↘	9.0 ←	9.5 ↗	10.1 ↑
9.0 ↘	9.2 ↗	9.0 ↑	9.0 ↗	8.6 ←

**beste Teiler: 210.2 (5.), 350.8 (1.), 372.0 (4.)**  
**Trefferlage: 1.41 mm links, 2.26 mm hoch**  
**Streuwert: 2.78, horizontal: 3.37, vertikal: 2.03**

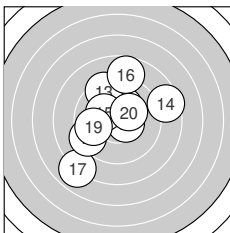

**Serie 2: 94.8 (90)**

10.5* ↘	10.2* ↑	9.4 ↘	8.5 →	10.2* ↘
8.7 ↑	7.9 ↙	9.3 ↙	9.8 ←	10.3* ↗

**beste Teiler: 105.8 (11.), 167.6 (20.), 185.9 (12.)**  
**Trefferlage: 0.47 mm links, 0.55 mm hoch**  
**Streuwert: 3.10, horizontal: 3.09, vertikal: 3.11**

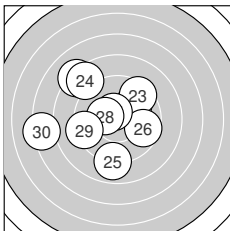

**Serie 3: 91.9 (87)**

8.2 ↘	9.9 ↗	9.4 ↗	8.5 ↘	8.9 ↓
9.6 →	10.6* ↘	10.3* ←	9.3 ←	7.2 ←

**beste Teiler: 99.8 (27.), 154.4 (28.), 252.1 (22.)**  
**Trefferlage: 1.71 mm links, 0.64 mm hoch**  
**Streuwert: 3.46, horizontal: 3.83, vertikal: 3.06**

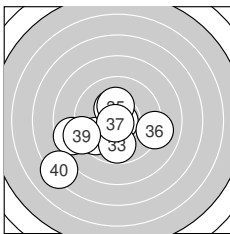

**Serie 4: 95.7 (91)**

10.8* ↘	9.6 ↙	9.8 ↓	10.3* ↘	10.3* ↑
9.1 →	10.8* ↙	8.6 ←	9.1 ←	7.3 ↙

**beste Teiler: 28.0 (31.), 47.0 (37.), 152.7 (34.)**  
**Trefferlage: 1.59 mm links, 1.31 mm tief**  
**Streuwert: 2.83, horizontal: 3.34, vertikal: 2.21**



Ergebnis: **387.3** (368)  
 Serien: 95.8 99.2 96.2 96.1  
 Zähler: 14 21 4 1 0 0 0 0 0 0  
 Innenezehner: 8  
 Weitester: 812 (40.), 748 (9.), 717 (25.)  
 beste Teiler: 73.0 (37.), 73.3 (22.), 155.1 (29.)  
 Trefferlage: 0.41 mm links, 0.57 mm tief  
 Streuwert: 2.52, horizontal: 2.99, vertikal: 1.94

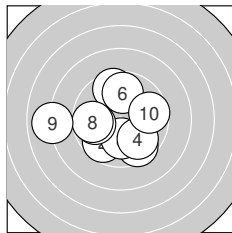
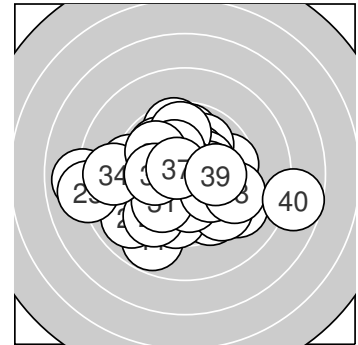

**Serie 1: 95.8 (90)**

9.6 ↘	9.7 ↙	10.1 ↓	9.8 ↘	9.6 ↑
9.8 ↑	9.8 ←	9.7 ←	8.0 ←	9.7 →

beste Teiler: 210.1 (3.), 282.6 (7.), 283.4 (4.)  
 Trefferlage: 0.89 mm links, 0.39 mm tief  
 Streuwert: 2.67, horizontal: 3.09, vertikal: 2.17

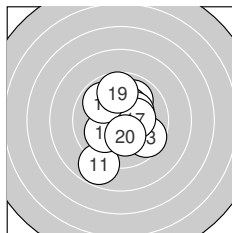

**Serie 2: 99.2 (94)**

8.8 ↙	10.1 ↙	9.6 ↘	9.9 ↗	10.3* ↗
10.3* ↗	10.3* →	9.9 ↘	9.7 ↑	10.3* ↓

beste Teiler: 160.0 (17.), 161.0 (15.), 167.8 (16.)  
 Trefferlage: 0.20 mm rechts, 0.00 mm  
 Streuwert: 2.08, horizontal: 1.72, vertikal: 2.38

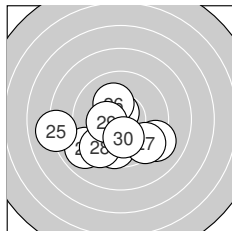

**Serie 3: 96.2 (93)**

9.2 ↘	10.7* ↑	9.7 ↓	9.0 ↙	8.1 ←
10.2* ↘	9.5 ↘	9.4 ↙	10.3* ←	10.1 ↓

beste Teiler: 73.3 (22.), 155.1 (29.), 187.9 (26.)  
 Trefferlage: 0.95 mm links, 1.55 mm tief  
 Streuwert: 2.50, horizontal: 3.10, vertikal: 1.72

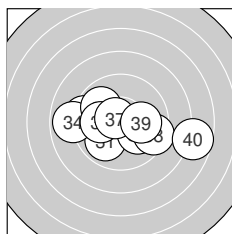

**Serie 4: 96.1 (91)**

9.9 ↙	10.1 ↘	9.3 ←	8.9 ←	9.9 ↘
10.1 ←	10.7* ↘	9.4 ↘	10.1 →	7.7 →

beste Teiler: 73.0 (37.), 218.0 (36.), 224.0 (39.)  
 Trefferlage: 0.01 mm links, 0.38 mm tief  
 Streuwert: 2.91, horizontal: 3.94, vertikal: 1.18



Ergebnis: **395.6** (378)  
 Serien: 99.4 98.5 98.7 99.0  
 Zähler: 18 22 0 0 0 0 0 0 0 0  
 Innenzehner: 13  
 Weitester: 482 (40.), 477 (22.), 468 (38.)  
 beste Teiler: 44.7 (36.), 59.5 (14.), 73.7 (30.)  
 Trefferlage: 0.28 mm rechts, 1.02 mm hoch  
 Streuwert: 1.98, horizontal: 2.05, vertikal: 1.91

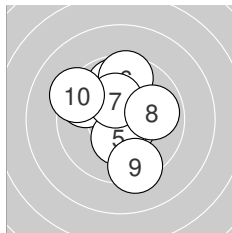
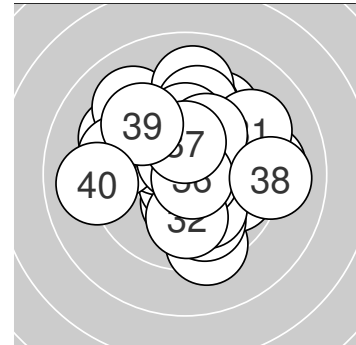

**Serie 1: 99.4 (94)**

10.5* →	9.7 ↖	10.6* ↘	9.8 ↑	10.3* ↓
9.6 ↑	10.3* ↑	9.9 →	9.4 ↓	9.3 ↖

beste Teiler: 86.2 (3.), 112.9 (1.), 152.0 (5.)  
 Trefferlage: 0.16 mm links, 0.62 mm hoch  
 Streuwert: 2.00, horizontal: 1.86, vertikal: 2.14

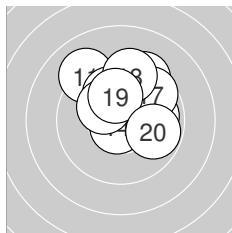

**Serie 2: 98.5 (94)**

9.1 ↖	9.9 →	10.0 ↖	10.7* ↗	9.4 ↑
10.3* ↖	9.7 ↗	9.5 ↑	10.1 ↑	9.8 →

beste Teiler: 59.5 (14.), 174.9 (16.), 204.5 (19.)  
 Trefferlage: 0.44 mm rechts, 1.69 mm hoch  
 Streuwert: 1.79, horizontal: 1.90, vertikal: 1.66

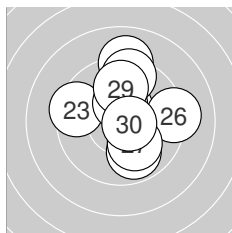

**Serie 3: 98.7 (94)**

10.5* ↑	9.0 ↑	9.5 ↖	10.4* ↑	9.9 ↓
9.2 →	10.1 ↓	9.5 ↑	9.9 ↑	10.7* →

beste Teiler: 73.7 (30.), 114.5 (21.), 148.0 (24.)  
 Trefferlage: 0.51 mm rechts, 1.06 mm hoch  
 Streuwert: 2.10, horizontal: 1.92, vertikal: 2.27

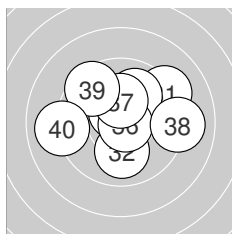

**Serie 4: 99.0 (96)**

9.2 ↗	10.0 ↓	10.5* ↗	10.0 ↗	10.6* ↖
10.8* ↘	10.3* ↑	9.1 →	9.5 ↖	9.0 ←

beste Teiler: 44.7 (36.), 93.9 (35.), 120.2 (33.)  
 Trefferlage: 0.33 mm rechts, 0.72 mm hoch  
 Streuwert: 2.21, horizontal: 2.68, vertikal: 1.59





Ergebnis: **384.6** (367)  
 Serien: 97.0 96.6 94.4 96.6  
 Zähler: 15 17 8 0 0 0 0 0 0 0  
 Innenzehner: 12  
 Weitester: 692 (6.), 661 (18.), 620 (1.)  
 beste Teiler: 100.6 (8.), 101.3 (24.), 112.0 (40.)  
 Trefferlage: 1.48 mm rechts, 0.30 mm tief  
 Streuwert: 2.47, horizontal: 2.79, vertikal: 2.10

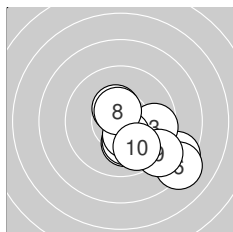
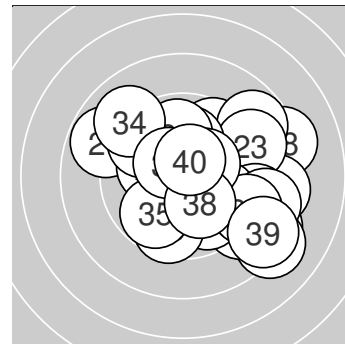

**Serie 1: 97.0 (93)**

8.5 ↘	10.1 ↓	9.7 →	10.4* ↖	10.2* ↓
8.2 ↘	10.4* ↓	10.6* ↑	9.1 ↘	9.8 ↘

beste Teiler: 100.6 (8.), 129.8 (4.), 137.6 (7.)  
 Trefferlage: 1.98 mm rechts, 1.64 mm tief  
 Streuwert: 2.03, horizontal: 2.26, vertikal: 1.76

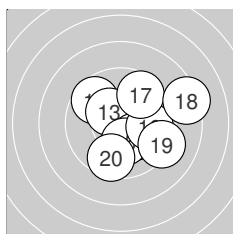

**Serie 2: 96.6 (92)**

9.7 →	9.7 ↖	10.3* ↖	10.2* ↘	10.2* ↓
9.8 →	9.6 ↗	8.3 →	9.2 ↘	9.6 ↓

beste Teiler: 152.0 (13.), 180.0 (15.), 184.5 (14.)  
 Trefferlage: 1.49 mm rechts, 0.16 mm tief  
 Streuwert: 2.35, horizontal: 2.61, vertikal: 2.06

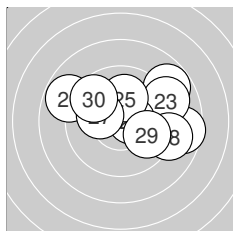

**Serie 3: 94.4 (90)**

8.6 →	8.8 ↗	9.1 →	10.5* →	10.1 ↑
8.8 ↖	10.1 ↖	9.0 →	9.8 ↘	9.6 ↖

beste Teiler: 101.3 (24.), 203.1 (27.), 221.9 (25.)  
 Trefferlage: 1.35 mm rechts, 0.87 mm hoch  
 Streuwert: 2.80, horizontal: 3.58, vertikal: 1.67

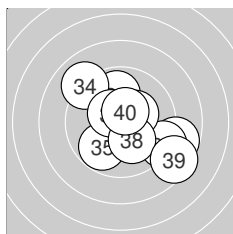

**Serie 4: 96.6 (92)**

8.8 →	9.1 ↘	9.9 ↑	9.0 ↖	9.8 ↗
10.3* ↗	10.5* ↖	10.2* ↓	8.5 ↘	10.5* ↑

beste Teiler: 112.0 (40.), 122.4 (37.), 157.6 (36.)  
 Trefferlage: 1.08 mm rechts, 0.26 mm tief  
 Streuwert: 2.64, horizontal: 2.91, vertikal: 2.33



Ergebnis: **391.1** (373)  
 Serien: 97.6 98.7 97.5 97.3  
 Zähler: 19 15 6 0 0 0 0 0 0 0  
 Innenzehner: 12  
 Weitester: 611 (7.), 595 (34.), 558 (27.)  
 beste Teiler: 22.3 (40.), 67.7 (9.), 78.8 (39.)  
 Trefferlage: 0.14 mm rechts, 0.84 mm hoch  
 Streuwert: 2.30, horizontal: 2.59, vertikal: 1.98

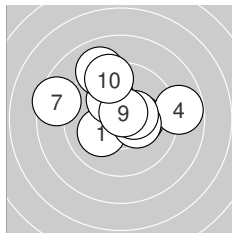
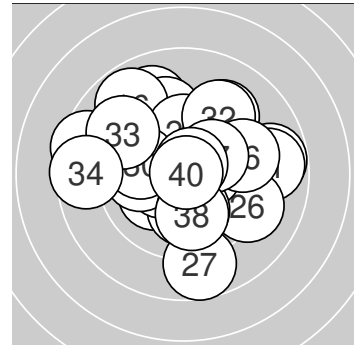

**Serie 1: 97.6 (94)**

10.1 ↙	10.1 ↘	10.3* →	8.8 →	10.3* →
9.0 ↘	8.5 ↙	10.4* →	10.7* ↑	9.4 ↑

beste Teiler: 67.7 (9.), 129.3 (8.), 154.2 (5.)  
 Trefferlage: 0.14 mm links, 1.18 mm hoch  
 Streuwert: 2.44, horizontal: 2.96, vertikal: 1.77

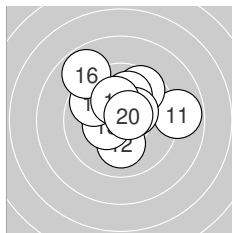

**Serie 2: 98.7 (94)**

8.8 →	10.1 ↓	10.4* ↙	9.8 ↘	9.6 ↗
8.8 ↘	10.0 ↑	10.4* ↗	10.2* ↘	10.6* ↗

beste Teiler: 85.9 (20.), 136.0 (13.), 145.6 (18.)  
 Trefferlage: 0.23 mm rechts, 1.19 mm hoch  
 Streuwert: 2.10, horizontal: 2.37, vertikal: 1.78

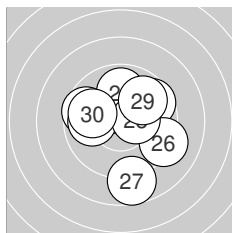

**Serie 3: 97.5 (91)**

10.5* ↘	9.6 ↗	9.9 ↑	9.6 ↙	9.9 ←
9.2 ↘	8.7 ↓	10.4* →	9.8 ↗	9.9 ↙

beste Teiler: 118.9 (21.), 140.9 (28.), 262.0 (25.)  
 Trefferlage: 0.25 mm rechts, 0.17 mm hoch  
 Streuwert: 2.40, horizontal: 2.45, vertikal: 2.35

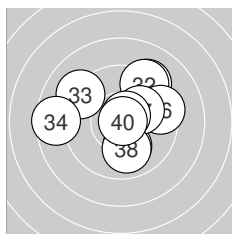

**Serie 4: 97.3 (94)**

9.2 ↗	9.3 ↗	9.2 ↘	8.6 ←	10.0 ↓
9.4 →	10.1 ↗	10.0 ↓	10.6* ↗	10.9* ↗

beste Teiler: 22.3 (40.), 78.8 (39.), 209.7 (37.)  
 Trefferlage: 0.23 mm rechts, 0.80 mm hoch  
 Streuwert: 2.54, horizontal: 2.92, vertikal: 2.07



Ergebnis: **607.6** (584)  
 Serien: 102.0 102.9 100.0 102.4 100.2 100.1  
 Zähler: 46 12 2 0 0 0 0 0 0 0  
 Innenezehner: 30  
 Weitester: 644 (46.), 578 (25.), 473 (60.)  
 beste Teiler: 8.2 (30.), 26.9 (42.), 35.9 (53.)  
 Trefferlage: 0.30 mm rechts, 0.17 mm hoch  
 Streuwert: 1.71, horizontal: 2.05, vertikal: 1.27

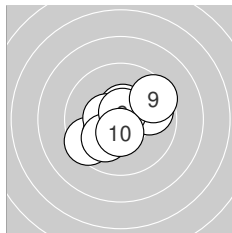
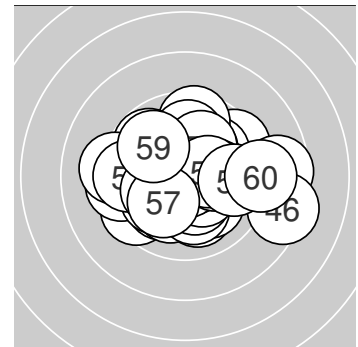

**Serie 1: 102.0 (97)**

10.8* ↙	9.8 →	9.5 ↙	10.2* ↙	10.5* ↑
10.4* ←	10.1 ↙	10.7* ↑	9.5 ↘	10.5* ↓

beste Teiler: 41.8 (1.), 67.4 (8.), 105.1 (5.)  
 Trefferlage: 0.13 mm links, 0.20 mm tief  
 Streuwert: 1.62, horizontal: 1.86, vertikal: 1.33

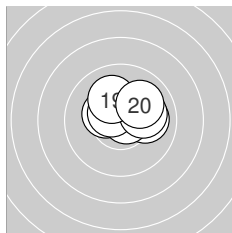

**Serie 2: 102.9 (100)**

10.1 →	10.0 →	10.4* ↖	10.5* ↗	10.5* ↗
10.7* →	10.5* ↖	10.1 →	10.1 ↖	10.0 ↗

beste Teiler: 54.0 (16.), 101.3 (14.), 109.6 (17.)  
 Trefferlage: 0.74 mm rechts, 0.68 mm hoch  
 Streuwert: 1.05, horizontal: 1.36, vertikal: 0.60

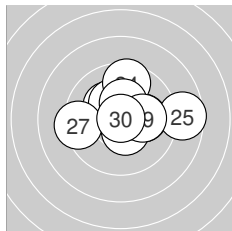

**Serie 3: 100.0 (96)**

10.2* ↖	10.1 →	10.3* ↖	9.6 ↑	8.6 →
10.3* ↑	9.4 ←	10.5* ↓	10.1 →	10.9* ↑

beste Teiler: 8.2 (30.), 121.6 (28.), 154.0 (26.)  
 Trefferlage: 0.52 mm rechts, 0.65 mm hoch  
 Streuwert: 2.01, horizontal: 2.54, vertikal: 1.29

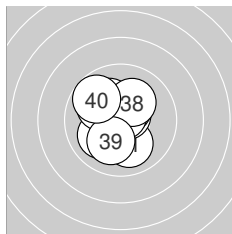

**Serie 4: 102.4 (99)**

10.0 ↓	10.0 ↙	10.2* ↖	10.7* ↗	10.5* ↑
10.8* ↑	10.1 ↖	10.2* ↗	10.1 ↙	9.8 ↖

beste Teiler: 46.5 (36.), 71.6 (34.), 122.9 (35.)  
 Trefferlage: 0.45 mm links, 0.29 mm hoch  
 Streuwert: 1.42, horizontal: 1.25, vertikal: 1.56

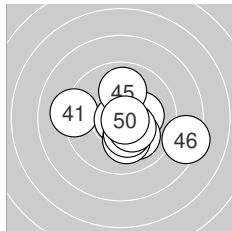

**Serie 5: 100.2 (96)**

9.2 ←	10.8* ↙	10.2* →	10.1 ↓	9.9 ↑
8.4 →	10.1 ↓	10.3* ↓	10.4* ↓	10.8* ↘

beste Teiler: 26.9 (42.), 45.6 (50.), 141.1 (49.)  
 Trefferlage: 0.76 mm rechts, 0.50 mm tief  
 Streuwert: 2.05, horizontal: 2.54, vertikal: 1.40

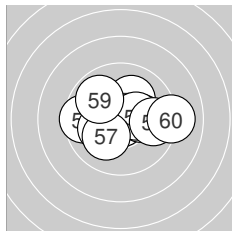

**Serie 6: 100.1 (96)**

10.1 ↑	9.6 ←	10.8* ↓	10.2* ↙	10.2* →
10.4* →	10.1 ↙	9.7 →	9.9 ↖	9.1 →

beste Teiler: 35.9 (53.), 145.7 (56.), 189.1 (55.)  
 Trefferlage: 0.36 mm rechts, 0.10 mm hoch  
 Streuwert: 1.95, horizontal: 2.54, vertikal: 1.07

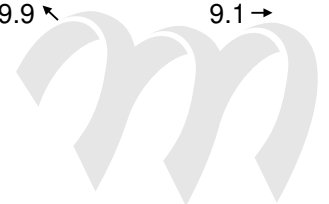

Ergebnis: **618.1** (591)  
 Serien: 100.1 103.9 105.1 102.8 103.6 102.6  
 Zähler: 51 9 0 0 0 0 0 0 0 0  
 Innenzehner: 44  
 Weitestе: 483 (33.), 428 (9.), 353 (7.)  
 beste Teiler: 29.5 (46.), 33.3 (12.), 36.6 (23.)  
 Trefferlage: 0.30 mm links, 0.45 mm tief  
 Streuwert: 1.31, horizontal: 1.38, vertikal: 1.23

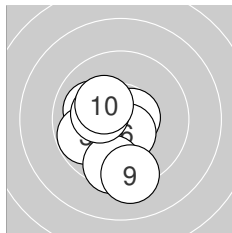
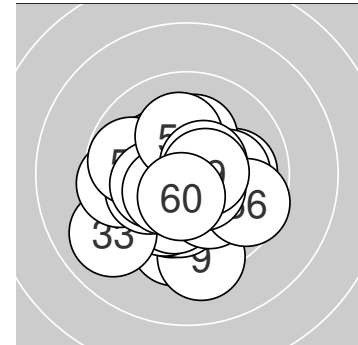

**Serie 1: 100.1 (96)**

10.0 ←	10.2* ↙	9.8 ←	10.6* →	9.7 ↓
10.5* ↓	9.5 ↓	10.3* ←	9.2 ↓	10.3* ↘

beste Teiler: 82.0 (4.), 114.1 (6.), 165.4 (8.)  
 Trefferlage: 0.76 mm links, 1.22 mm tief  
 Streuwert: 1.58, horizontal: 1.20, vertikal: 1.87

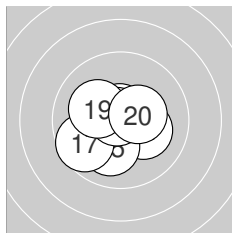

**Serie 2: 103.9 (99)**

10.7* ←	10.8* ↓	10.3* ←	10.2* →	10.1 ↓
10.7* ↑	9.7 ↙	10.8* ↘	10.2* ↘	10.4* →

beste Teiler: 33.3 (12.), 38.8 (18.), 54.3 (11.)  
 Trefferlage: 0.46 mm links, 0.27 mm tief  
 Streuwert: 1.19, horizontal: 1.37, vertikal: 0.97

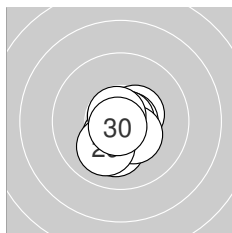

**Serie 3: 105.1 (100)**

10.5* →	10.7* →	10.8* →	10.6* ↓	10.4* ↙
10.1 ↓	10.4* ↘	10.7* ↘	10.1 ↙	10.8* ↙

beste Teiler: 36.6 (23.), 46.1 (30.), 51.6 (28.)  
 Trefferlage: 0.06 mm rechts, 0.64 mm tief  
 Streuwert: 0.83, horizontal: 0.74, vertikal: 0.92

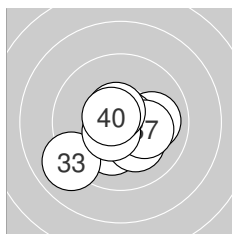

**Serie 4: 102.8 (99)**

10.7* ↘	10.2* ↓	9.0 ↙	10.2* ↓	10.0 →
10.8* →	10.2* →	10.5* ↙	10.6* ↘	10.6* ↘

beste Teiler: 45.6 (36.), 51.8 (31.), 83.8 (40.)  
 Trefferlage: 0.00 mm, 0.65 mm tief  
 Streuwert: 1.47, horizontal: 1.72, vertikal: 1.17

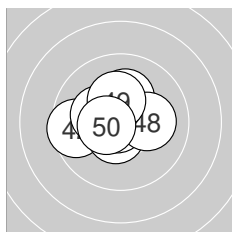

**Serie 5: 103.6 (99)**

10.8* ←	9.6 ←	10.5* →	10.3* ←	10.5* ↓
10.8* ←	10.2* ↑	10.1 →	10.3* ↑	10.5* ←

beste Teiler: 29.5 (46.), 39.8 (41.), 101.9 (45.)  
 Trefferlage: 0.41 mm links, 0.30 mm hoch  
 Streuwert: 1.22, horizontal: 1.47, vertikal: 0.89

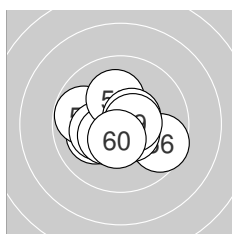

**Serie 6: 102.6 (98)**

10.1 ←	9.8 ←	10.2* ←	10.4* ↙	10.2* ↑
9.6 →	10.6* ↘	10.6* →	10.6* →	10.5* ↓

beste Teiler: 94.4 (59.), 98.6 (58.), 100.7 (57.)  
 Trefferlage: 0.26 mm links, 0.22 mm tief  
 Streuwert: 1.42, horizontal: 1.73, vertikal: 1.03

