

Ergebnis: **194.1** (186)  
 Serien: 95.6 98.5  
 Zähler: 9 8 3 0 0 0 0 0 0 0  
 Innenzehner: 6  
 Weitester: 740 (2.), 565 (7.), 557 (9.)  
 beste Teiler: 90.2 (15.), 122.2 (20.), 128.5 (8.)  
 Trefferlage: 0.43 mm rechts, 0.63 mm tief  
 Streuwert: 2.52, horizontal: 2.76, vertikal: 2.24

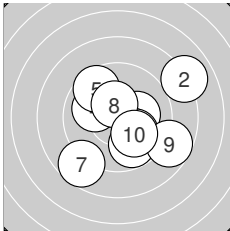
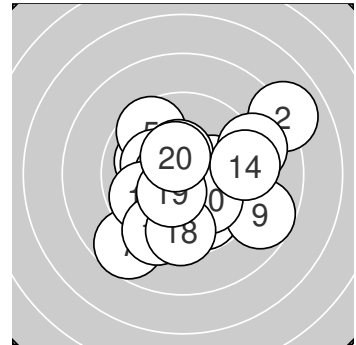

**Serie 1: 95.6 (92)**

9.8 ↘      8.0 ↗      10.2\* →  
 10.1 ↘      8.7 ↙      10.4\* ↑  
 beste Teiler: 128.5 (8.), 188.6 (3.), 220.5 (6.)  
 Trefferlage: 0.99 mm rechts, 0.38 mm tief  
 Streuwert: 2.86, horizontal: 3.12, vertikal: 2.57

10.0 ←      9.6 ↖  
 8.7 →      10.1 ↘

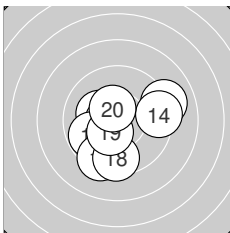

**Serie 2: 98.5 (94)**

9.1 →      10.2\* ←      9.7 ↙      9.3 →      10.6\* ←  
 9.8 ↖      9.4 ↙      9.5 ↓      10.4\* ↙      10.5\* ↑  
 beste Teiler: 90.2 (15.), 122.2 (20.), 135.3 (19.)  
 Trefferlage: 0.12 mm links, 0.87 mm tief  
 Streuwert: 2.19, horizontal: 2.39, vertikal: 1.96



Ergebnis: **187.6** (178)  
 Serien: 95.0 92.6  
 Zähler: 7 4 9 0 0 0 0 0 0 0 0  
 Innenzehner: 4  
 Weitester: 643 (5.), 589 (15.), 589 (17.)  
 beste Teiler: 152.0 (4.), 174.1 (14.), 176.4 (1.)  
 Trefferlage: 0.76 mm rechts, 0.24 mm tief  
 Streuwert: 3.06, horizontal: 3.59, vertikal: 2.41

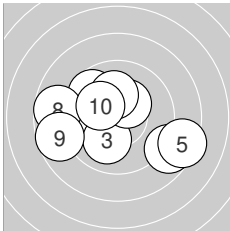
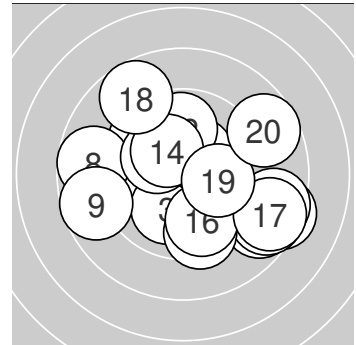

**Serie 1: 95.0 (91)**

10.2\* ←      8.7 ↘      10.0 ↙      10.3\* ↗      8.4 →  
 9.7 ↘      10.1 ↑      8.7 ←      8.7 ←      10.2\* ↘  
 beste Teiler: 152.0 (4.), 176.4 (1.), 191.0 (10.)  
 Trefferlage: 0.61 mm links, 0.26 mm tief  
 Streuwert: 2.97, horizontal: 3.73, vertikal: 1.93

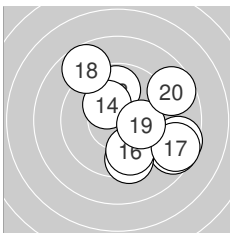

**Serie 2: 92.6 (87)**

8.6 ↘      9.8 ↑      9.5 ↓      10.3\* ↘      8.6 →  
 9.7 ↓      8.6 ↘      8.7 ↘      10.1 →      8.7 ↗  
 beste Teiler: 174.1 (14.), 219.4 (19.), 278.3 (12.)  
 Trefferlage: 2.14 mm rechts, 0.22 mm tief  
 Streuwert: 2.97, horizontal: 3.01, vertikal: 2.92



Ergebnis: **190.1** (180)  
 Serien: 92.1 98.0  
 Zähler: 8 8 3 0 0 0 1 0 0 0 0  
 Innenzehner: 6  
 Weitester: 1685 (5.), 665 (4.), 665 (11.)  
 beste Teiler: 58.1 (15.), 90.4 (18.), 94.3 (19.)  
 Trefferlage: 1.78 mm rechts, 1.34 mm hoch  
 Streuwert: 3.27, horizontal: 4.37, vertikal: 1.53

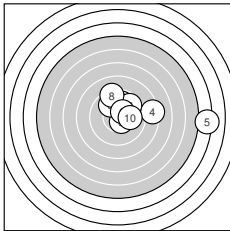
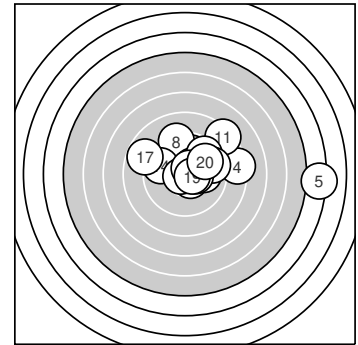

**Serie 1: 92.1 (88)**

9.9 ↗ 10.0 ↑ 10.5\* ↘ 8.3 → 4.2 →  
 9.9 ↘ 9.7 ↗ 9.2 ↑ 10.4\* ↗ 10.0 →  
 beste Teiler: 105.5 (3.), 137.4 (9.), 230.6 (2.)  
 Trefferlage: 2.84 mm rechts, 1.38 mm hoch  
 Streuwert: 3.98, horizontal: 5.39, vertikal: 1.62

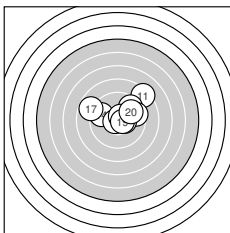

**Serie 2: 98.0 (92)**

8.3 ↗ 9.6 ↗ 9.5 → 9.7 ← 10.7\* ←  
 10.4\* → 8.8 ↖ 10.6\* ↗ 10.6\* → 9.8 ↗  
 beste Teiler: 58.1 (15.), 90.4 (18.), 94.3 (19.)  
 Trefferlage: 0.73 mm rechts, 1.31 mm hoch  
 Streuwert: 2.36, horizontal: 2.96, vertikal: 1.53



Ergebnis: **201.4** (192)  
 Serien: 101.2 100.2  
 Zähler: 12 8 0 0 0 0 0 0 0 0  
 Innenzehner: 11  
 Weitester: 488 (16.), 438 (6.), 407 (12.)  
 beste Teiler: 23.0 (19.), 64.4 (5.), 96.1 (14.)  
 Trefferlage: 0.43 mm links, 0.35 mm tief  
 Streuwert: 1.80, horizontal: 2.19, vertikal: 1.29

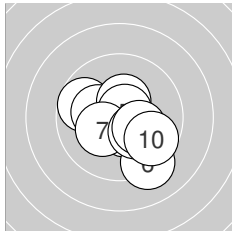
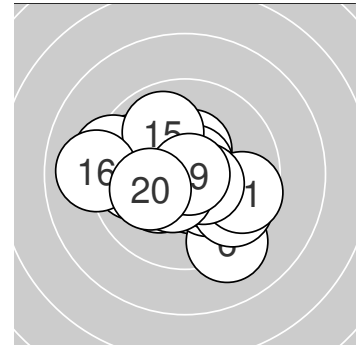

**Serie 1: 101.2 (97)**

9.7 ↖	10.5* ↘	10.2* ←	10.4* ↑	10.7* ↗
9.2 ↘	10.3* ↗	10.3* ↘	10.2* ↘	9.7 ↘

beste Teiler: 64.4 (5.), 115.0 (2.), 136.3 (4.)  
 Trefferlage: 0.30 mm rechts, 0.63 mm tief  
 Streuwert: 1.67, horizontal: 1.82, vertikal: 1.51

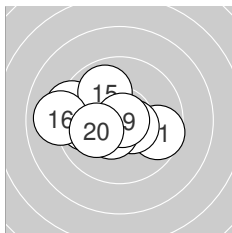

**Serie 2: 100.2 (95)**

9.6 →	9.3 ←	9.8 ←	10.6* ↙	9.9 ↖
9.0 ←	10.5* ↘	10.5* ↙	10.9* →	10.1 ↙

beste Teiler: 23.0 (19.), 96.1 (14.), 114.4 (17.)  
 Trefferlage: 1.16 mm links, 0.08 mm tief  
 Streuwert: 1.83, horizontal: 2.37, vertikal: 1.04



Ergebnis: **200.9** (194)  
 Serien: 102.2 98.7  
 Zähler: 17 1 1 1 0 0 0 0 0 0 0  
 Innenzehner: 12  
 Weitester: 983 (13.), 554 (10.), 276 (5.)  
 beste Teiler: 65.0 (7.), 79.2 (3.), 94.3 (1.)  
 Trefferlage: 0.54 mm links, 0.44 mm hoch  
 Streuwert: 2.13, horizontal: 2.84, vertikal: 1.00

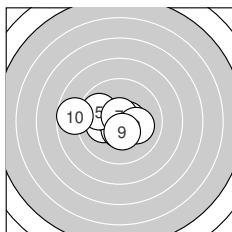
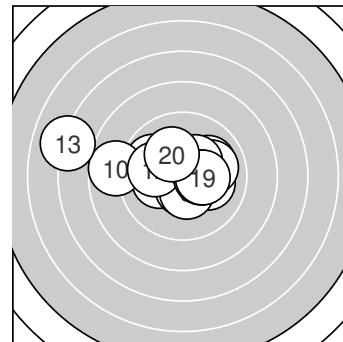

**Serie 1: 102.2 (97)**

10.6\* ↓      10.2\* ←      10.6\* ↖      10.5\* ↓      9.8 ↖  
 10.6\* →      10.7\* ↑      10.1 →      10.4\* ↓      8.7 ←

beste Teiler: 65.0 (7.), 79.2 (3.), 94.3 (1.)  
 Trefferlage: 0.71 mm links, 0.10 mm tief  
 Streuwert: 1.62, horizontal: 2.13, vertikal: 0.84

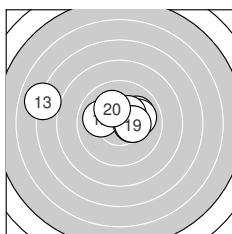

**Serie 2: 98.7 (97)**

10.2\* ↖      10.0 ←      7.0 ←      10.4\* →      10.0 →  
 10.0 →      10.3\* ↗      10.4\* →      10.3\* →      10.1 ↖

beste Teiler: 133.2 (14.), 148.4 (18.), 153.0 (17.)  
 Trefferlage: 0.38 mm links, 0.99 mm hoch  
 Streuwert: 2.56, horizontal: 3.52, vertikal: 0.87



Ergebnis: **196.5** (186)  
 Serien: 100.7 95.8  
 Zähler: 6 14 0 0 0 0 0 0 0 0 0  
 Innenzehner: 4  
 Weitester: 479 (11.), 435 (15.), 411 (14.)  
 beste Teiler: 42.9 (4.), 61.0 (10.), 106.2 (19.)  
 Trefferlage: 0.49 mm rechts, 0.23 mm tief  
 Streuwert: 2.17, horizontal: 2.50, vertikal: 1.77

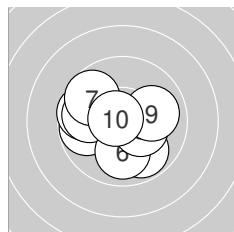
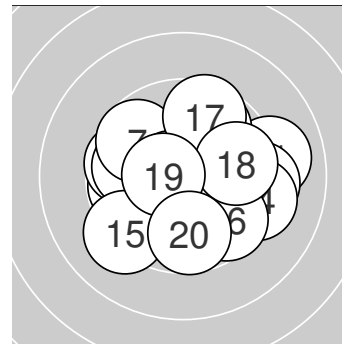

**Serie 1: 100.7 (95)**

9.8 ←                      9.8 ↘                      9.7 ←  
 10.0 ↓                      9.7 ↙                      10.3\* →  
 beste Teiler: 42.9 (4.), 61.0 (10.), 157.3 (8.)  
 Trefferlage: 0.67 mm links, 0.21 mm tief  
 Streuwert: 1.72, horizontal: 2.02, vertikal: 1.35

10.8\* ←                      9.9 ←  
 10.0 →                      10.7\* ←

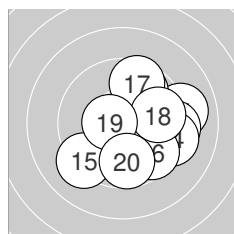

**Serie 2: 95.8 (91)**

9.0 →                      9.8 ↗                      9.3 →                      9.3 →                      9.2 ✓  
 9.6 ↘                      9.6 ↗                      9.8 →                      10.5\* ←                      9.7 ↓  
 beste Teiler: 106.2 (19.), 292.9 (12.), 294.9 (18.)  
 Trefferlage: 1.66 mm rechts, 0.25 mm tief  
 Streuwert: 2.33, horizontal: 2.46, vertikal: 2.20



Ergebnis: **183.9** (175)  
 Serien: 91.9 92.0  
 Zähler: 4 10 4 1 1 0 0 0 0 0 0  
 Innenzehner: 3  
 Weitester: 1016 (6.), 828 (16.), 682 (1.)  
 beste Teiler: 44.8 (9.), 93.0 (8.), 135.0 (20.)  
 Trefferlage: 0.08 mm rechts, 1.04 mm tief  
 Streuwert: 3.53, horizontal: 4.27, vertikal: 2.60

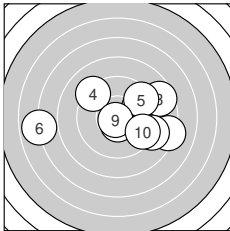
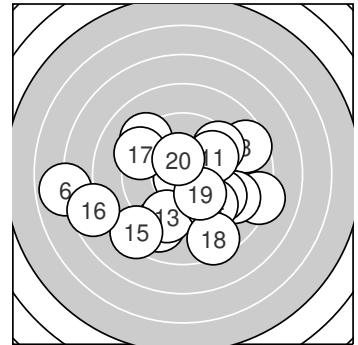

**Serie 1: 91.9 (87)**

8.2 ↘	9.7 ↗	8.6 ↗	9.2 ↖	9.4 ↗
6.9 ←	9.0 ↘	10.6* ↓	10.8* ↖	9.5 ↘

beste Teiler: 44.8 (9.), 93.0 (8.), 309.0 (2.)  
 Trefferlage: 1.18 mm rechts, 0.05 mm hoch  
 Streuwert: 3.74, horizontal: 4.90, vertikal: 2.00

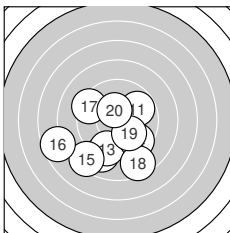

**Serie 2: 92.0 (88)**

9.8 ↗	9.0 ↘	9.4 ↘	9.5 ↘	8.4 ↘
7.6 ←	9.3 ↖	8.5 ↘	10.1 ↘	10.4* ↗

beste Teiler: 135.0 (20.), 222.4 (19.), 291.7 (11.)  
 Trefferlage: 1.01 mm links, 2.13 mm tief  
 Streuwert: 3.11, horizontal: 3.43, vertikal: 2.76



Ergebnis: **177.8** (168)  
 Serien: 92.8 85.0  
 Zähler: 5 5 5 4 0 1 0 0 0 0 0  
 Innenzehner: 4  
 Weitester: 1399 (20.), 949 (12.), 869 (14.)  
 beste Teiler: 43.2 (19.), 154.4 (4.), 164.6 (6.)  
 Trefferlage: 0.18 mm links, 0.05 mm hoch  
 Streuwert: 4.43, horizontal: 5.12, vertikal: 3.61

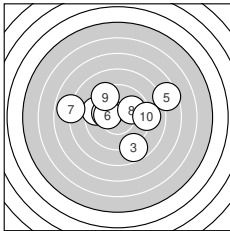
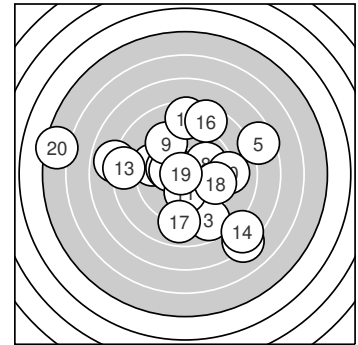

**Serie 1: 92.8 (88)**

9.5 ←	10.1 ←	8.8 ↘	10.3* ←	7.5 →
10.3* ←	7.9 ←	9.9 →	9.4 ↘	9.1 →

beste Teiler: 154.4 (4.), 164.6 (6.), 204.2 (2.)  
 Trefferlage: 0.05 mm links, 0.72 mm hoch  
 Streuwert: 3.51, horizontal: 4.42, vertikal: 2.26

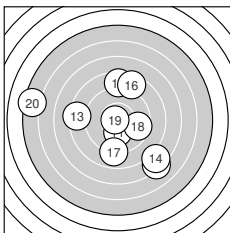

**Serie 2: 85.0 (80)**

10.2* ↓	7.2 ↘	8.3 ←	7.5 ↘	8.6 ↑
8.5 ↑	8.9 ↓	9.6 →	10.8* ←	5.4 ←

beste Teiler: 43.2 (19.), 194.0 (11.), 339.8 (18.)  
 Trefferlage: 0.32 mm links, 0.60 mm tief  
 Streuwert: 5.35, horizontal: 5.98, vertikal: 4.63





Ergebnis: **184.9** (177)  
 Serien: 94.4 90.5  
 Zähler: 3 12 4 1 0 0 0 0 0 0  
 Innenzehner: 1  
 Weitester: 944 (17.), 709 (11.), 700 (19.)  
 beste Teiler: 199.4 (12.), 228.8 (10.), 246.7 (16.)  
 Trefferlage: 0.48 mm links, 0.00 mm  
 Streuwert: 3.40, horizontal: 4.17, vertikal: 2.39

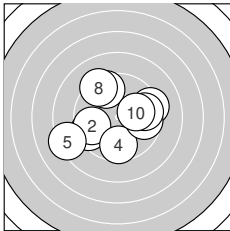
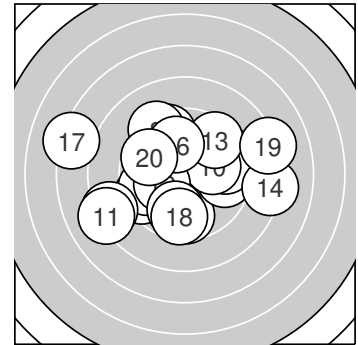

**Serie 1: 94.4 (90)**

9.4 ↙	9.7 ↙	9.3 →	9.6 ↓	8.3 ↙
9.7 →	9.5 ↗	9.3 ↘	9.6 →	10.0 →

beste Teiler: 228.8 (10.), 319.5 (6.), 323.8 (2.)  
 Trefferlage: 0.35 mm links, 0.01 mm hoch  
 Streuwert: 2.92, horizontal: 3.40, vertikal: 2.34

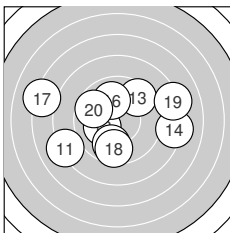

**Serie 2: 90.5 (87)**

8.1 ↙	10.2* ↙	9.5 ↗	8.2 →	9.8 ↓
10.0 ↗	7.2 ↙	9.6 ↓	8.2 →	9.7 ↘

beste Teiler: 199.4 (12.), 246.7 (16.), 291.3 (15.)  
 Trefferlage: 0.61 mm links, 0.00 mm  
 Streuwert: 3.98, horizontal: 5.02, vertikal: 2.56



Ergebnis: **200.3** (193)  
 Serien: 100.7 99.6  
 Zähler: 14 5 1 0 0 0 0 0 0 0  
 Innenzehner: 11  
 Weitesten: 592 (11.), 432 (1.), 411 (14.)  
 beste Teiler: 45.2 (15.), 84.1 (8.), 120.3 (7.)  
 Trefferlage: 0.26 mm rechts, 0.82 mm hoch  
 Streuwert: 1.87, horizontal: 1.67, vertikal: 2.05

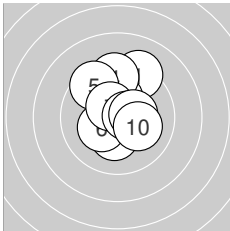
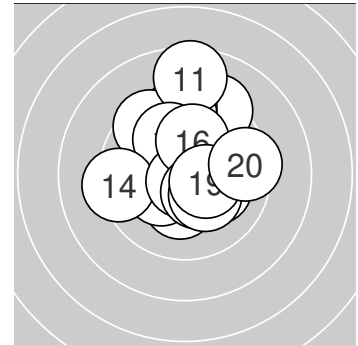

**Serie 1: 100.7 (97)**

9.2 ↗ 10.3\* ↑ 10.3\* ↓  
 10.3\* ↖ 10.5\* ↘ 10.6\* →  
 beste Teiler: 84.1 (8.), 120.3 (7.), 146.5 (9.)  
 Trefferlage: 0.12 mm rechts, 1.01 mm hoch  
 Streuwert: 1.71, horizontal: 1.38, vertikal: 1.98

9.5 ↑ 9.5 ↘  
 10.4\* → 10.1 ↘

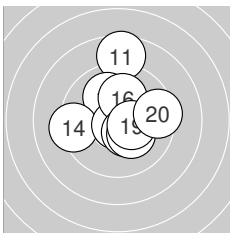

**Serie 2: 99.6 (96)**

8.6 ↑ 10.3\* → 10.0 ↘  
 10.1 ↑ 10.4\* ↘ 10.2\* ↘  
 beste Teiler: 45.2 (15.), 133.7 (17.), 135.6 (19.)  
 Trefferlage: 0.41 mm rechts, 0.64 mm hoch  
 Streuwert: 2.10, horizontal: 1.99, vertikal: 2.20

9.3 ← 10.8\* ↓  
 10.4\* → 9.5 →



Ergebnis: **202.1** (194)  
 Serien: 101.1 101.0  
 Zähler: 14 6 0 0 0 0 0 0 0 0 0  
 Innenzehner: 10  
 Weitester: 485 (16.), 432 (10.), 356 (17.)  
 beste Teiler: 12.1 (1.), 59.2 (6.), 68.0 (11.)  
 Trefferlage: 0.22 mm links, 0.44 mm tief  
 Streuwert: 1.74, horizontal: 1.72, vertikal: 1.76

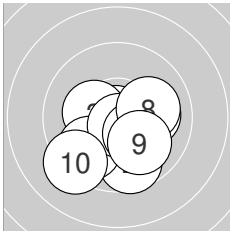
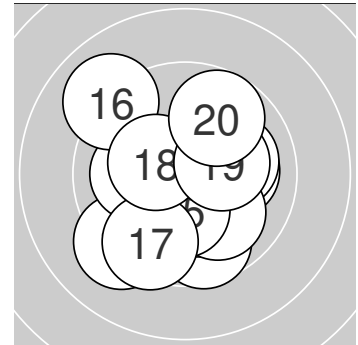

**Serie 1: 101.1 (97)**

10.9* ←	9.7 ↓	10.3* ←	9.8 ↙	10.1 →
10.7* ↓	10.3* ↘	10.1 →	10.0 ↘	9.2 ↙

beste Teiler: 12.1 (1.), 59.2 (6.), 164.1 (7.)  
 Trefferlage: 0.13 mm rechts, 1.08 mm tief  
 Streuwert: 1.62, horizontal: 1.80, vertikal: 1.41

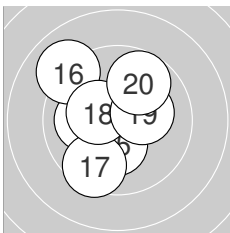

**Serie 2: 101.0 (97)**

10.7* ↙	10.1 ←	10.5* ↗	10.6* ↙	10.3* ↓
9.0 ↘	9.5 ↙	10.4* ↖	10.2* →	9.7 ↗

beste Teiler: 68.0 (11.), 81.4 (14.), 101.4 (13.)  
 Trefferlage: 0.58 mm links, 0.19 mm hoch  
 Streuwert: 1.78, horizontal: 1.64, vertikal: 1.90



Ergebnis: **194.3** (186)  
 Serien: 97.8 96.5  
 Zähler: 10 7 2 1 0 0 0 0 0 0 0  
 Innenzehner: 8  
 Weitester: 809 (19.), 614 (5.), 612 (17.)  
 beste Teiler: 28.0 (8.), 73.5 (12.), 105.0 (18.)  
 Trefferlage: 0.75 mm links, 0.19 mm hoch  
 Streuwert: 2.60, horizontal: 2.92, vertikal: 2.24

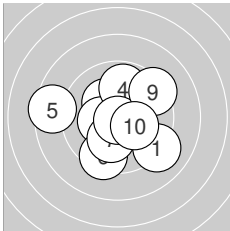
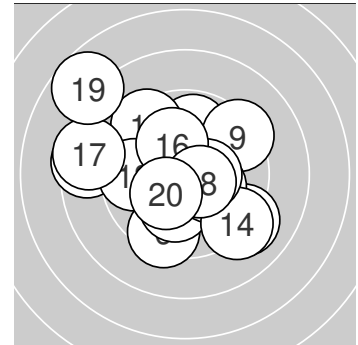

**Serie 1: 97.8 (94)**

9.1 ↘	10.3* ↘	10.3* ←	9.8 ↑	8.5 ←
9.4 ↓	10.1 ↓	10.8* ↓	9.3 ↗	10.2* ↘

beste Teiler: 28.0 (8.), 154.7 (3.), 175.6 (2.)  
 Trefferlage: 0.16 mm links, 0.25 mm tief  
 Streuwert: 2.48, horizontal: 2.78, vertikal: 2.13

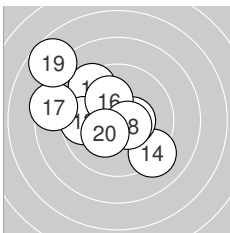

**Serie 2: 96.5 (92)**

9.4 ↘	10.7* ↘	9.7 ←	9.2 ↘	10.4* →
10.1 ↘	8.5 ←	10.5* ↘	7.7 ↘	10.3* ↘

beste Teiler: 73.5 (12.), 105.0 (18.), 130.0 (15.)  
 Trefferlage: 1.34 mm links, 0.64 mm hoch  
 Streuwert: 2.75, horizontal: 3.09, vertikal: 2.36



Ergebnis: **202.1** (191)  
 Serien: 100.1 102.0  
 Zähler: 11 9 0 0 0 0 0 0 0 0 0  
 Innenzehner: 9  
 Weitesten: 410 (4.), 403 (5.), 374 (19.)  
 beste Teiler: 48.3 (12.), 49.0 (8.), 68.6 (18.)  
 Trefferlage: 0.16 mm rechts, 0.57 mm hoch  
 Streuwert: 1.72, horizontal: 1.88, vertikal: 1.55

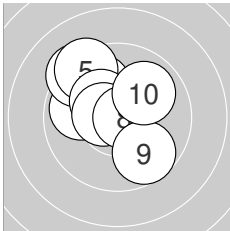
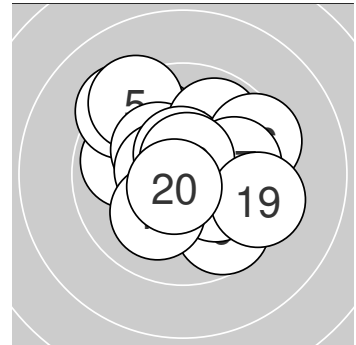

**Serie 1: 100.1 (94)**

9.9 ←	9.9 ↖	10.5* ↖	9.3 ↖	9.3 ↖
10.3* ↖	10.5* ←	10.8* →	9.7 ↘	9.9 ↗

beste Teiler: 49.0 (8.), 101.9 (7.), 116.0 (3.)  
 Trefferlage: 0.77 mm links, 1.05 mm hoch  
 Streuwert: 1.69, horizontal: 1.69, vertikal: 1.68

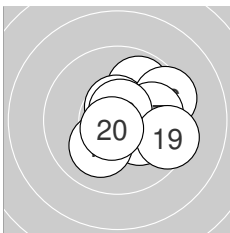

**Serie 2: 102.0 (97)**

9.9 ↗	10.8* ↘	10.6* ↑	10.2* ↘	10.1 ↙
9.5 ↗	10.0 →	10.7* ↑	9.5 →	10.7* ↙

beste Teiler: 48.3 (12.), 68.6 (18.), 71.8 (20.)  
 Trefferlage: 1.10 mm rechts, 0.09 mm hoch  
 Streuwert: 1.47, horizontal: 1.63, vertikal: 1.30



Ergebnis: **194.8** (185)  
 Serien: 96.2 98.6  
 Zähler: 9 8 2 1 0 0 0 0 0 0 0  
 Innenzehner: 5  
 Weitester: 780 (4.), 562 (14.), 507 (3.)  
 beste Teiler: 10.0 (15.), 67.9 (5.), 93.9 (8.)  
 Trefferlage: 0.01 mm rechts, 0.74 mm tief  
 Streuwert: 2.54, horizontal: 2.78, vertikal: 2.27

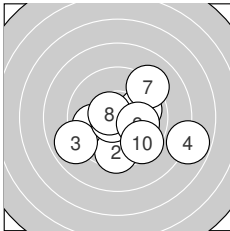
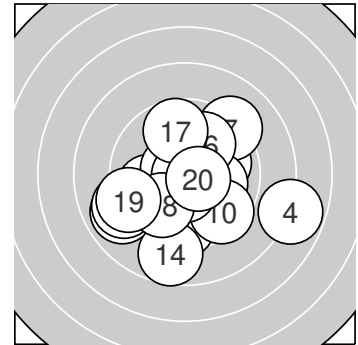

**Serie 1: 96.2 (91)**

9.9 ←                      9.5 ↓                      8.9 ←                      7.8 →                      10.7\* ←  
 10.0 →                      9.2 ↗                      10.6\* ↖                      10.1 →                      9.5 ↘  
 beste Teiler: 67.9 (5.), 93.9 (8.), 222.3 (9.)  
 Trefferlage: 0.91 mm rechts, 0.89 mm tief  
 Streuwert: 2.75, horizontal: 3.31, vertikal: 2.04

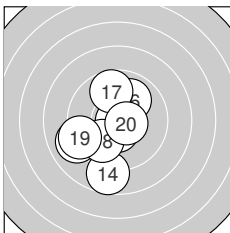

**Serie 2: 98.6 (94)**

9.0 ←                      10.5\* ↓                      10.1 ↑                      8.7 ↓                      10.9\* ←  
 10.0 ↗                      9.7 ↑                      9.9 ←                      9.2 ←                      10.6\* →  
 beste Teiler: 10.0 (15.), 97.7 (20.), 112.0 (12.)  
 Trefferlage: 0.88 mm links, 0.59 mm tief  
 Streuwert: 2.26, horizontal: 1.90, vertikal: 2.57



Ergebnis: **185.1** (176)  
 Serien: 92.1 93.0  
 Zähler: 4 9 6 1 0 0 0 0 0 0 0  
 Innenzehner: 3  
 Weitestе: 814 (11.), 707 (9.), 660 (19.)  
 beste Teiler: 41.1 (17.), 76.0 (20.), 151.4 (3.)  
 Trefferlage: 0.36 mm rechts, 0.40 mm hoch  
 Streuwert: 3.39, horizontal: 3.33, vertikal: 3.44

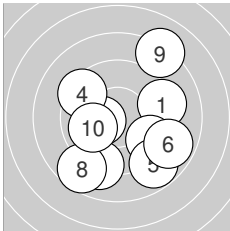
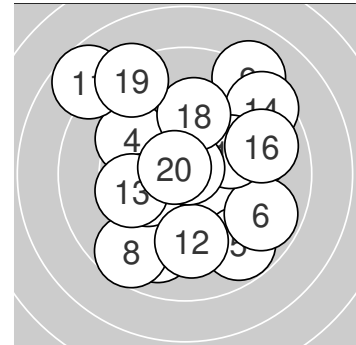

**Serie 1: 92.1 (88)**

9.3 → 9.5 ↘ 10.3\* ← 9.4 ↖ 8.8 ↘  
 8.9 ↘ 9.1 ↓ 8.7 ↙ 8.1 ↗ 10.0 ←

beste Teiler: 151.4 (3.), 246.0 (10.), 363.6 (2.)  
 Trefferlage: 0.69 mm rechts, 0.97 mm tief  
 Streuwert: 3.35, horizontal: 3.33, vertikal: 3.36

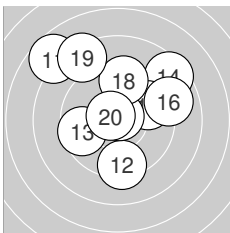

**Serie 2: 93.0 (88)**

7.7 ↖ 9.3 ↓ 9.6 ← 8.5 ↗ 9.7 ↘  
 9.0 → 10.8\* ↗ 9.5 ↑ 8.3 ↖ 10.6\* ↘

beste Teiler: 41.1 (17.), 76.0 (20.), 309.9 (15.)  
 Trefferlage: 0.02 mm rechts, 1.78 mm hoch  
 Streuwert: 3.28, horizontal: 3.47, vertikal: 3.08



Ergebnis: **396.0** (374)  
 Serien: 98.0 101.8 99.0 97.2  
 Zähler: 15 24 1 0 0 0 0 0 0 0  
 Innenzehner: 14  
 Weitester: 507 (36.), 474 (17.), 472 (23.)  
 beste Teiler: 1.0 (37.), 52.3 (21.), 68.8 (18.)  
 Trefferlage: 0.69 mm links, 0.16 mm hoch  
 Streuwert: 2.03, horizontal: 2.59, vertikal: 1.23

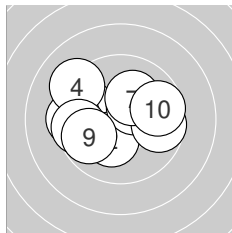
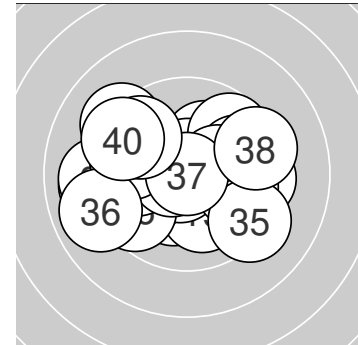

**Serie 1: 98.0 (93)**

9.8 ↖	10.2* ↘	9.4 ←	9.2 ↖	10.4* ↗
9.7 →	10.2* ↗	9.6 ←	9.8 ↖	9.7 →

beste Teiler: 146.5 (5.), 178.6 (2.), 198.3 (7.)  
 Trefferlage: 0.85 mm links, 0.31 mm hoch  
 Streuwert: 2.15, horizontal: 2.72, vertikal: 1.37

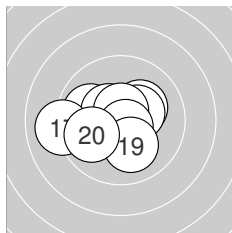

**Serie 2: 101.8 (97)**

9.9 ↖	10.2* ↗	10.4* ←	10.4* ↗	10.5* ↖
10.6* ↑	9.1 ←	10.7* ↘	10.1 ↘	9.9 ↖

beste Teiler: 68.8 (18.), 77.0 (16.), 122.4 (15.)  
 Trefferlage: 0.75 mm links, 0.05 mm tief  
 Streuwert: 1.58, horizontal: 1.99, vertikal: 1.00

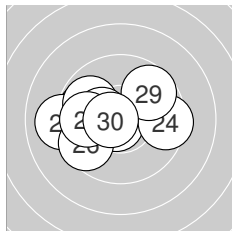

**Serie 3: 99.0 (93)**

10.7* ↖	9.8 ↖	9.1 ←	9.5 →	9.8 ↖
9.6 ↖	10.3* ↖	9.9 ←	9.7 ↗	10.6* ←

beste Teiler: 52.3 (21.), 81.2 (30.), 155.7 (27.)  
 Trefferlage: 1.22 mm links, 0.16 mm hoch  
 Streuwert: 1.96, horizontal: 2.55, vertikal: 1.09

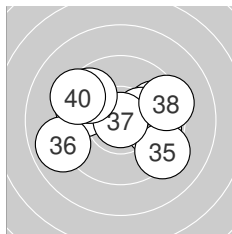

**Serie 4: 97.2 (91)**

9.8 →	9.8 →	10.3* →	9.7 ↖	9.3 ↘
8.9 ↖	10.9* ↑	9.4 →	9.7 ↖	9.4 ↖

beste Teiler: 1.0 (37.), 172.2 (33.), 278.9 (31.)  
 Trefferlage: 0.05 mm rechts, 0.23 mm hoch  
 Streuwert: 2.52, horizontal: 3.21, vertikal: 1.55





**Ergebnis: 384.3 (363)**  
**Serien: 96.7 98.3 92.7 96.6**  
**Zähler: 13 19 6 2 0 0 0 0 0 0**  
**Innenzehner: 10**  
**Weiteste: 846 (8.), 752 (25.), 636 (35.)**  
**beste Teiler: 15.0 (34.), 65.0 (7.), 66.2 (1.)**  
**Trefferlage: 0.22 mm links, 0.25 mm hoch**  
**Streuwert: 2.75, horizontal: 2.96, vertikal: 2.51**

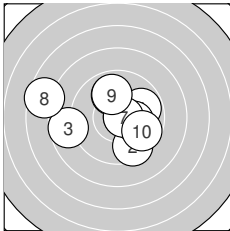
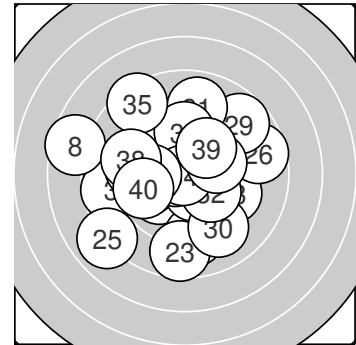

**Serie 1: 96.7 (90)**

10.7\* →      9.5 ↘      8.7 ←      9.8 →      10.2\* →  
 9.9 ↑      10.7\* →      7.6 ←      9.9 ↑      9.7 ↘  
**beste Teiler: 65.0 (7.), 66.2 (1.), 184.3 (5.)**  
**Trefferlage: 0.49 mm links, 0.19 mm hoch**  
**Streuwert: 2.88, horizontal: 3.61, vertikal: 1.89**

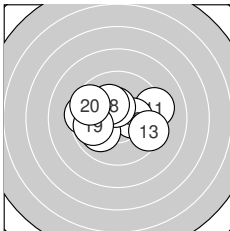

**Serie 2: 98.3 (94)**

9.2 →      10.3\* →      9.5 ↘      9.7 ←      10.0 ✓  
 10.5\* ↑      9.5 ←      10.2\* ↘      9.8 ←      9.6 ↘  
**beste Teiler: 125.5 (16.), 171.0 (12.), 179.0 (18.)**  
**Trefferlage: 0.63 mm links, 0.32 mm hoch**  
**Streuwert: 2.17, horizontal: 2.83, vertikal: 1.18**

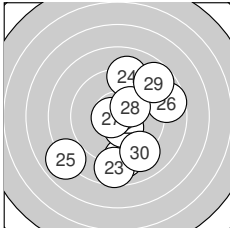

**Serie 3: 92.7 (88)**

9.1 ↓      10.4\* ↘      8.7 ↓      9.1 ↑      7.9 ✓  
 8.7 →      10.7\* ←      10.3\* ↗      8.7 ↗      9.1 ↘  
**beste Teiler: 72.7 (27.), 142.2 (22.), 175.8 (28.)**  
**Trefferlage: 0.89 mm rechts, 0.96 mm tief**  
**Streuwert: 3.38, horizontal: 3.03, vertikal: 3.69**

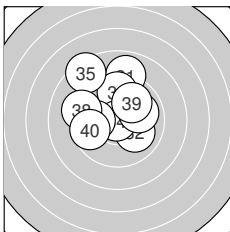

**Serie 4: 96.6 (91)**

8.9 ↑      10.0 ↘      9.7 ↑      10.9\* ✓      8.4 ↘  
 9.9 ←      10.0 →      9.3 ←      9.9 ↗      9.6 ✓  
**beste Teiler: 15.0 (34.), 234.3 (32.), 250.1 (37.)**  
**Trefferlage: 0.65 mm links, 1.47 mm hoch**  
**Streuwert: 2.39, horizontal: 2.43, vertikal: 2.34**



**Ergebnis: 389.4 (372)**  
**Serien:** 97.1 94.6 99.3 98.4  
**Zähler:** 14 24 2 0 0 0 0 0 0 0  
**Innenzehner:** 12  
**Weiteste:** 674 (36.), 557 (19.), 498 (16.)  
**beste Teiler:** 41.7 (10.), 104.6 (21.), 116.8 (18.)  
**Trefferlage:** 0.03 mm links, 0.40 mm tief  
**Streuwert:** 2.38, horizontal: 2.28, vertikal: 2.47

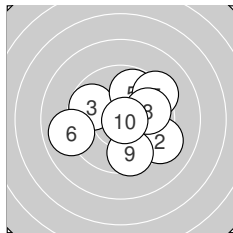
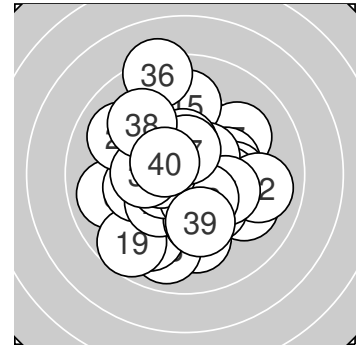

**Serie 1: 97.1 (92)**

9.8 ↘	9.2 ↘	9.7 ↖	10.0 ↗	9.8 ↑
9.0 ←	9.3 ↗	9.9 →	9.6 ↓	10.8* →

**beste Teiler:** 41.7 (10.), 226.9 (4.), 275.5 (8.)  
**Trefferlage:** 0.78 mm rechts, 0.07 mm tief  
**Streuwert:** 2.40, horizontal: 2.68, vertikal: 2.09

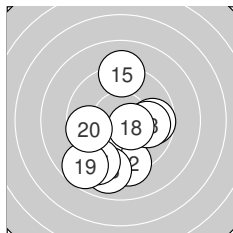

**Serie 2: 94.6 (90)**

9.7 →	9.3 ↓	9.9 →	9.6 ↙	9.1 ↑
9.0 ↓	9.1 ↙	10.5* ↘	8.7 ↙	9.7 ←

**beste Teiler:** 116.8 (18.), 263.3 (13.), 310.2 (11.)  
**Trefferlage:** 0.45 mm links, 1.74 mm tief  
**Streuwert:** 2.60, horizontal: 2.31, vertikal: 2.86

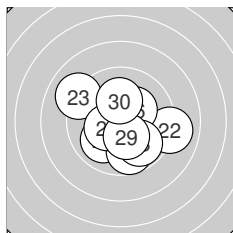

**Serie 3: 99.3 (96)**

10.5* ↙	9.0 →	9.1 ↖	10.0 ↙	9.7 ↓
10.3* ↗	10.4* ↖	9.8 ↘	10.3* ↓	10.2* ↑

**beste Teiler:** 104.6 (21.), 144.0 (27.), 157.3 (29.)  
**Trefferlage:** 0.16 mm rechts, 0.52 mm tief  
**Streuwert:** 2.09, horizontal: 2.35, vertikal: 1.79

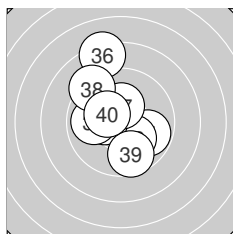

**Serie 4: 98.4 (94)**

9.8 ↘	10.2* ↘	10.4* ↖	10.3* ←	9.9 ←
8.3 ↑	10.3* ↑	9.2 ↘	9.7 ↓	10.3* ↖

**beste Teiler:** 144.2 (33.), 152.4 (40.), 154.0 (34.)  
**Trefferlage:** 0.62 mm links, 0.73 mm hoch  
**Streuwert:** 2.27, horizontal: 1.78, vertikal: 2.68



Ergebnis: **379.1** (364)  
 Serien: 95.3 96.8 90.5 96.5  
 Zähler: 12 21 6 1 0 0 0 0 0 0  
 Innenzehner: 9  
 Weitester: 850 (36.), 736 (35.), 675 (21.)  
 beste Teiler: 67.3 (33.), 85.7 (40.), 135.3 (37.)  
 Trefferlage: 0.36 mm rechts, 0.13 mm hoch  
 Streuwert: 2.92, horizontal: 3.63, vertikal: 1.96

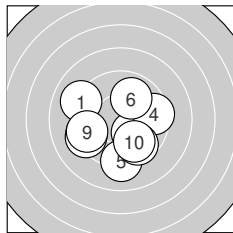
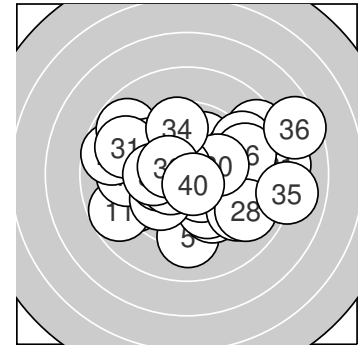

**Serie 1: 95.3 (91)**

9.1 ↖	9.4 ↙	10.2* ↘	9.5 →	9.1 ↓
9.9 ↗	9.6 ↘	9.3 ↙	9.4 ↖	9.8 ↘

beste Teiler: 189.3 (3.), 254.4 (6.), 282.8 (10.)  
 Trefferlage: 0.59 mm links, 1.10 mm tief  
 Streuwert: 2.55, horizontal: 2.93, vertikal: 2.12

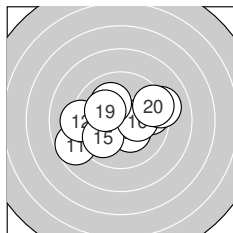

**Serie 2: 96.8 (93)**

8.7 ↙	9.2 ←	10.3* ↘	9.7 →	9.9 ↙
10.2* →	9.1 →	10.1 ↘	10.2* ↖	9.4 →

beste Teiler: 161.7 (13.), 183.0 (16.), 196.2 (19.)  
 Trefferlage: 0.01 mm rechts, 0.07 mm hoch  
 Streuwert: 2.55, horizontal: 3.26, vertikal: 1.52

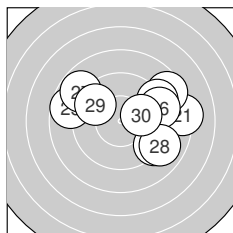

**Serie 3: 90.5 (87)**

8.3 →	9.2 ↘	8.6 ↗	9.1 ↗	8.7 ↖
9.2 →	8.8 ↖	9.0 ↘	9.6 ↖	10.0 →

beste Teiler: 232.2 (30.), 327.8 (29.), 444.9 (26.)  
 Trefferlage: 1.75 mm rechts, 0.95 mm hoch  
 Streuwert: 3.36, horizontal: 4.28, vertikal: 2.06

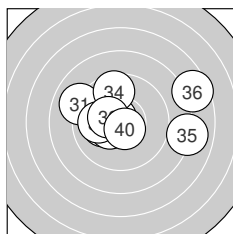

**Serie 4: 96.5 (93)**

9.0 ↖	10.2* ↙	10.7* ↘	9.6 ↑	8.0 →
7.6 →	10.4* ↙	10.0 ←	10.4* ↖	10.6* ↘

beste Teiler: 67.3 (33.), 85.7 (40.), 135.3 (37.)  
 Trefferlage: 0.30 mm rechts, 0.63 mm hoch  
 Streuwert: 3.08, horizontal: 4.02, vertikal: 1.69



**Ergebnis: 378.0 (359)**  
**Serien:** 92.1 97.3 94.7 93.9  
**Zähler:** 12 16 11 1 0 0 0 0 0 0  
**Innenzehner:** 9  
**Weiteste:** 791 (31.), 748 (8.), 736 (24.)  
**beste Teiler:** 29.2 (32.), 36.1 (3.), 45.8 (22.)  
**Trefferlage:** 2.40 mm links, 0.58 mm tief  
**Streuwert:** 2.53, horizontal: 2.30, vertikal: 2.73

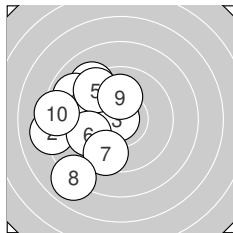
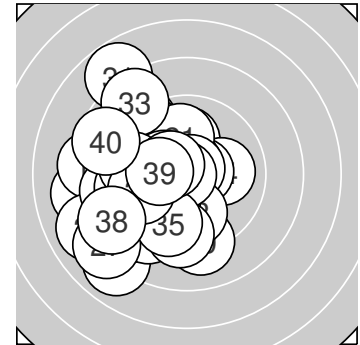

**Serie 1: 92.1 (88)**

9.2 ↘	8.2 ←	10.8* ←	8.9 ↘	9.4 ↘
9.6 ←	9.5 ↘	8.0 ↗	10.1 ↑	8.4 ←

**beste Teiler:** 36.1 (3.), 224.0 (9.), 348.1 (6.)  
**Trefferlage:** 3.27 mm links, 0.03 mm tief  
**Streuwert:** 2.67, horizontal: 2.32, vertikal: 2.98

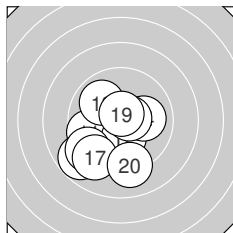

**Serie 2: 97.3 (93)**

9.6 ←	10.3* ↓	9.9 ↘	10.0 →	8.8 ↗
9.2 ↗	9.1 ↘	10.6* →	10.7* ↑	9.1 ↓

**beste Teiler:** 64.6 (19.), 87.8 (18.), 175.9 (12.)  
**Trefferlage:** 1.03 mm links, 1.49 mm tief  
**Streuwert:** 2.16, horizontal: 2.18, vertikal: 2.14

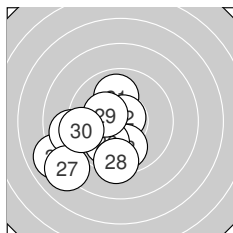

**Serie 3: 94.7 (90)**

10.0 ↑	10.8* ↗	9.9 ↓	8.0 ←	8.9 ←
9.9 ↗	8.1 ↗	9.4 ↓	10.3* ↘	9.4 ←

**beste Teiler:** 45.8 (22.), 165.7 (29.), 247.9 (21.)  
**Trefferlage:** 2.36 mm links, 1.53 mm tief  
**Streuwert:** 2.41, horizontal: 2.54, vertikal: 2.26

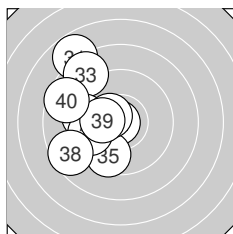

**Serie 4: 93.9 (88)**

7.8 ↘	10.8* ←	8.6 ↘	9.5 ←	9.6 ↘
10.5* ↘	9.7 ←	8.6 ←	10.2* ←	8.6 ↘

**beste Teiler:** 29.2 (32.), 124.5 (36.), 182.8 (39.)  
**Trefferlage:** 2.94 mm links, 0.74 mm hoch  
**Streuwert:** 2.52, horizontal: 1.77, vertikal: 3.09



**Ergebnis: 387.8 (372)**  
**Serien: 94.7 101.2 95.9 96.0**  
**Zähler: 16 20 4 0 0 0 0 0 0 0 0**  
**Innenzehner: 10**  
**Weiteste: 613 (2.), 552 (31.), 536 (8.)**  
**beste Teiler: 31.6 (20.), 137.8 (33.), 141.4 (6.)**  
**Trefferlage: 0.79 mm links, 0.01 mm hoch**  
**Streuwert: 2.41, horizontal: 2.78, vertikal: 1.96**

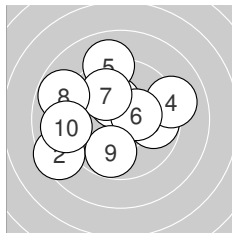
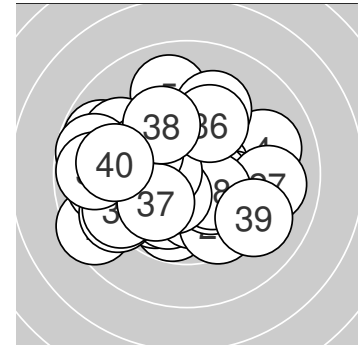

**Serie 1: 94.7 (91)**

10.3* ↖	8.5 ↙	9.8 →	9.1 →	9.0 ↑
10.4* →	10.0 ↘	8.8 ↘	9.8 ↓	9.0 ←

**beste Teiler: 141.4 (6.), 154.3 (1.), 249.7 (7.)**  
**Trefferlage: 1.00 mm links, 0.54 mm hoch**  
**Streuwert: 2.87, horizontal: 3.31, vertikal: 2.35**

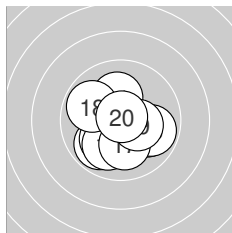

**Serie 2: 101.2 (97)**

10.2* ↑	9.9 ↙	10.1 ↙	10.0 →	10.0 ↓
9.9 →	10.1 ↓	9.9 ↘	10.3* →	10.8* ↑

**beste Teiler: 31.6 (20.), 152.8 (19.), 197.4 (11.)**  
**Trefferlage: 0.02 mm links, 0.67 mm tief**  
**Streuwert: 1.59, horizontal: 1.73, vertikal: 1.43**

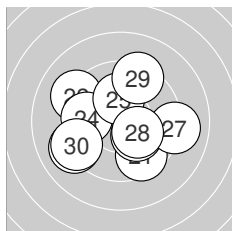

**Serie 3: 95.9 (93)**

9.6 ↓	9.2 ↘	10.2* ↘	9.8 ←	10.2* ↑
9.1 ↙	9.1 →	10.2* ↘	9.3 ↑	9.2 ↙

**beste Teiler: 176.9 (28.), 186.9 (23.), 196.6 (25.)**  
**Trefferlage: 0.39 mm links, 0.19 mm tief**  
**Streuwert: 2.67, horizontal: 3.06, vertikal: 2.20**

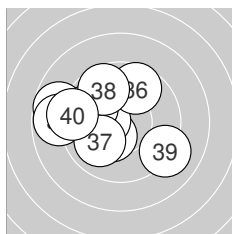

**Serie 4: 96.0 (91)**

8.7 ↖	10.4* ↙	10.4* ←	9.9 ↖	8.8 ←
9.7 ↑	10.0 ↙	9.7 ↘	9.1 →	9.3 ←

**beste Teiler: 137.8 (33.), 146.4 (32.), 243.5 (37.)**  
**Trefferlage: 1.76 mm links, 0.39 mm hoch**  
**Streuwert: 2.41, horizontal: 2.89, vertikal: 1.81**



**Ergebnis: 396.3 (377)**  
**Serien:** 100.0 98.6 100.6 97.1  
**Zähler:** 18 21 1 0 0 0 0 0 0 0  
**Innenzehner:** 11  
**Weiteste:** 564 (17.), 462 (35.), 408 (32.)  
**beste Teiler:** 57.2 (6.), 94.8 (10.), 106.7 (28.)  
**Trefferlage:** 0.83 mm links, 0.29 mm hoch  
**Streuwert:** 1.91, horizontal: 2.24, vertikal: 1.50

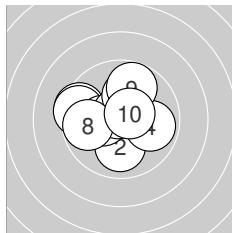
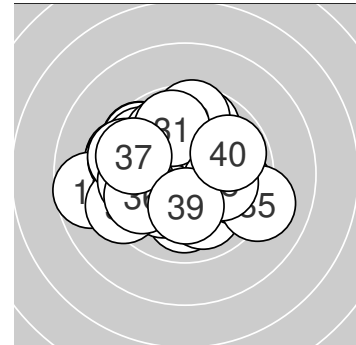

**Serie 1: 100.0 (95)**

9.4 ←	10.0 ↓	9.4 ←	9.9 →	10.3* ←
10.7* ↘	10.1 ↑	9.8 ←	9.8 ↑	10.6* ↗

**beste Teiler:** 57.2 (6.), 94.8 (10.), 156.4 (5.)  
**Trefferlage:** 0.70 mm links, 0.40 mm hoch  
**Streuwert:** 1.84, horizontal: 2.15, vertikal: 1.45

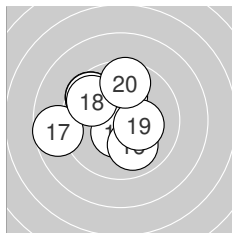

**Serie 2: 98.6 (94)**

10.1 ↑	9.6 ↘	9.6 ↘	10.5* ↘	10.5* ↓
10.0 ↓	8.7 ←	9.7 ↘	10.3* →	9.6 ↑

**beste Teiler:** 113.2 (15.), 124.3 (14.), 166.1 (19.)  
**Trefferlage:** 1.13 mm links, 0.75 mm hoch  
**Streuwert:** 2.00, horizontal: 2.19, vertikal: 1.79

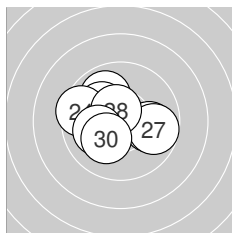

**Serie 3: 100.6 (96)**

9.9 ↘	10.3* ←	10.1 ↘	9.5 ←	9.9 →
10.4* ←	9.7 →	10.5* ↘	10.1 ←	10.2* ↗

**beste Teiler:** 106.7 (28.), 140.2 (26.), 167.2 (22.)  
**Trefferlage:** 0.75 mm links, 0.16 mm hoch  
**Streuwert:** 1.64, horizontal: 2.00, vertikal: 1.18

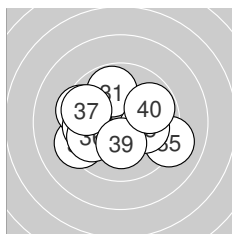

**Serie 4: 97.1 (92)**

9.8 ↑	9.3 ←	9.5 ←	9.8 ←	9.1 →
9.8 ←	9.7 ←	10.1 →	10.2* ↓	9.8 ↗

**beste Teiler:** 188.0 (39.), 215.3 (38.), 281.7 (31.)  
**Trefferlage:** 0.74 mm links, 0.15 mm tief  
**Streuwert:** 2.32, horizontal: 2.87, vertikal: 1.59



Ergebnis: **381.4** (364)  
 Serien: 95.5 94.1 99.8 92.0  
 Zähler: 12 21 6 1 0 0 0 0 0 0  
 Innenzehner: 7  
 Weitester: 891 (1.), 684 (40.), 656 (16.)  
 beste Teiler: 47.0 (28.), 50.5 (7.), 101.0 (9.)  
 Trefferlage: 0.80 mm rechts, 0.73 mm tief  
 Streuwert: 2.75, horizontal: 3.02, vertikal: 2.45

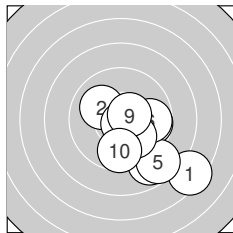
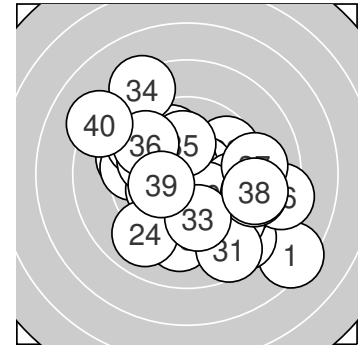

**Serie 1: 95.5 (90)**

7.4 ↘ 10.0 ↖ 9.7 → 8.8 ↘ 8.7 ↘  
 9.8 → 10.8\* ↘ 10.1 ↘ 10.5\* → 9.7 ↓  
 beste Teiler: 50.5 (7.), 101.0 (9.), 224.5 (8.)  
 Trefferlage: 2.03 mm rechts, 1.84 mm tief  
 Streuwert: 2.42, horizontal: 2.50, vertikal: 2.34

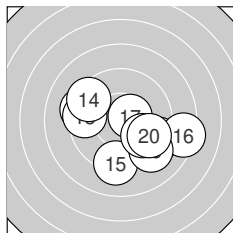

**Serie 2: 94.1 (90)**

9.2 ↘ 9.3 ↖ 9.5 ← 9.4 ↖ 9.2 ↓  
 8.3 → 10.5\* → 9.2 ↘ 9.9 ↘ 9.6 ↘  
 beste Teiler: 104.5 (17.), 275.1 (19.), 330.6 (20.)  
 Trefferlage: 0.81 mm rechts, 0.99 mm tief  
 Streuwert: 2.86, horizontal: 3.53, vertikal: 1.98

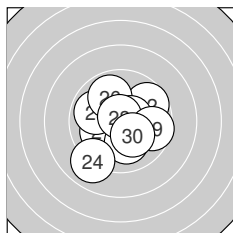

**Serie 3: 99.8 (95)**

10.1 ↖ 9.7 ↗ 10.1 ↓ 9.0 ↙ 9.9 ↖  
 9.9 ↖ 10.5\* ↗ 10.8\* ↑ 9.6 → 10.2\* ↘  
 beste Teiler: 47.0 (28.), 106.8 (27.), 185.0 (30.)  
 Trefferlage: 0.02 mm rechts, 0.35 mm tief  
 Streuwert: 2.01, horizontal: 2.09, vertikal: 1.91

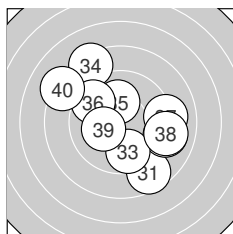

**Serie 4: 92.0 (89)**

8.6 ↘ 9.1 → 9.7 ↓ 8.3 ↖ 10.1 ↑  
 9.6 ↖ 9.1 → 9.1 → 10.2\* ↖ 8.2 ↖  
 beste Teiler: 187.5 (39.), 207.0 (35.), 306.0 (33.)  
 Trefferlage: 0.35 mm rechts, 0.26 mm hoch  
 Streuwert: 3.47, horizontal: 3.74, vertikal: 3.18



**Ergebnis: 400.8 (384)**  
**Serien:** 100.5 96.1 101.8 102.4  
**Zähler:** 26 12 2 0 0 0 0 0 0 0  
**Innenzehner:** 19  
**Weiteste:** 672 (16.), 521 (20.), 459 (2.)  
**beste Teiler:** 33.0 (7.), 44.1 (22.), 67.2 (26.)  
**Trefferlage:** 0.46 mm rechts, 0.47 mm hoch  
**Streuwert:** 1.90, horizontal: 2.05, vertikal: 1.74

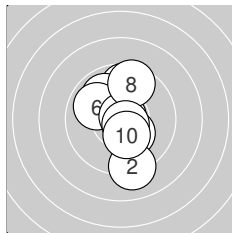
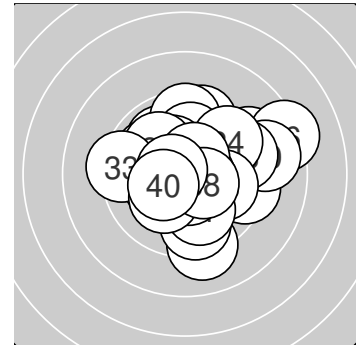

**Serie 1: 100.5 (95)**

10.3* ↘	9.1 ↓	9.7 ↑	10.3* ↖	9.9 ↗
9.9 ↖	10.8* ↗	9.5 ↑	10.7* ↘	10.3* ↓

**beste Teiler:** 33.0 (7.), 67.8 (9.), 159.5 (10.)  
**Trefferlage:** 0.00 mm , 0.37 mm hoch  
**Streuwert:** 1.89, horizontal: 1.16, vertikal: 2.40

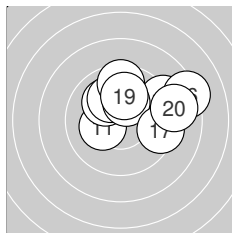

**Serie 2: 96.1 (93)**

10.2* ←	10.1 ↖	10.1 ↗	9.2 ↗	10.3* ↑
8.3 ↗	9.4 →	9.6 ↑	10.0 ↑	8.9 →

**beste Teiler:** 175.5 (15.), 180.2 (11.), 222.0 (12.)  
**Trefferlage:** 1.60 mm rechts, 1.52 mm hoch  
**Streuwert:** 2.27, horizontal: 2.91, vertikal: 1.35

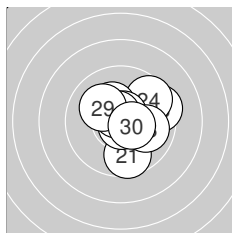

**Serie 3: 101.8 (97)**

9.7 ↓	10.8* ↓	9.4 →	9.6 ↗	10.3* ↖
10.7* ↑	10.7* ↖	10.0 →	10.1 ↖	10.5* ↘

**beste Teiler:** 44.1 (22.), 67.2 (26.), 74.3 (27.)  
**Trefferlage:** 0.79 mm rechts, 0.26 mm hoch  
**Streuwert:** 1.59, horizontal: 1.66, vertikal: 1.52

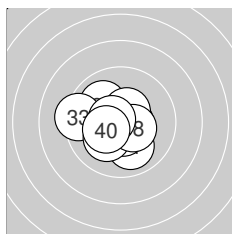

**Serie 4: 102.4 (99)**

10.0 ↓	10.0 ↖	9.3 ←	10.6* →	10.5* ↓
10.2* ↗	10.5* ↗	10.4* ↘	10.6* ↖	10.3* ↖

**beste Teiler:** 87.2 (39.), 92.4 (34.), 101.8 (35.)  
**Trefferlage:** 0.53 mm links, 0.26 mm tief  
**Streuwert:** 1.42, horizontal: 1.63, vertikal: 1.18





**Ergebnis: 379.9 (364)**  
**Serien: 89.7 96.6 94.8 98.8**  
**Zähler: 17 13 7 3 0 0 0 0 0 0 0**  
**Innenzehner: 9**  
**Weiteste: 983 (25.), 896 (9.), 846 (20.)**  
**beste Teiler: 23.0 (17.), 55.3 (38.), 78.5 (7.)**  
**Trefferlage: 0.48 mm rechts, 1.12 mm hoch**  
**Streuwert: 2.97, horizontal: 3.79, vertikal: 1.81**

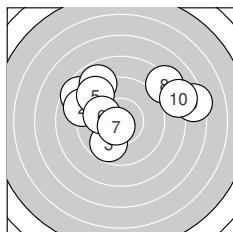
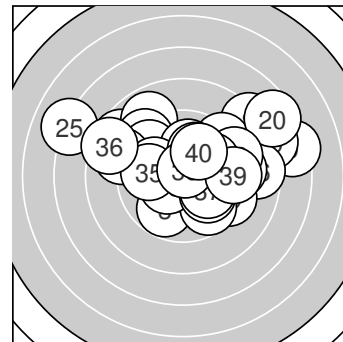

**Serie 1: 89.7 (86)**

8.6 ↖	9.0 ↖	9.8 ↘	8.9 ↖	9.2 ↖
10.0 ↖	10.6* ↘	8.2 ↗	7.4 →	8.0 →

**beste Teiler: 78.5 (7.), 234.9 (6.), 294.1 (3.)**  
**Trefferlage: 0.14 mm rechts, 1.91 mm hoch**  
**Streuwert: 3.82, horizontal: 4.93, vertikal: 2.21**

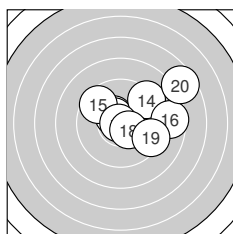

**Serie 2: 96.6 (91)**

9.9 →	10.4* ↖	10.5* ↖	9.3 ↗	9.6 ↖
8.6 →	10.9* ←	10.5* ↘	9.3 →	7.6 ↗

**beste Teiler: 23.0 (17.), 110.3 (13.), 123.5 (18.)**  
**Trefferlage: 1.86 mm rechts, 0.85 mm hoch**  
**Streuwert: 2.60, horizontal: 3.14, vertikal: 1.90**

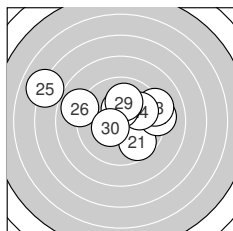

**Serie 3: 94.8 (91)**

9.7 ↘	9.2 →	9.2 →	9.9 →	7.0 ↖
8.9 ↖	10.1 ↑	10.4* ↑	10.0 ↑	10.4* ↘

**beste Teiler: 142.2 (28.), 144.5 (30.), 201.2 (27.)**  
**Trefferlage: 0.17 mm links, 1.13 mm hoch**  
**Streuwert: 3.15, horizontal: 4.10, vertikal: 1.74**

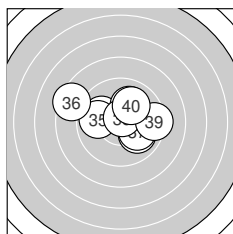

**Serie 4: 98.8 (96)**

10.4* →	10.0 ↘	10.0 ↖	10.1 ↗	9.9 ←
8.4 ↖	10.0 ↘	10.7* ↑	9.3 →	10.0 ↗

**beste Teiler: 55.3 (38.), 139.6 (31.), 225.3 (34.)**  
**Trefferlage: 0.09 mm rechts, 0.58 mm hoch**  
**Streuwert: 2.23, horizontal: 2.88, vertikal: 1.28**



Ergebnis: **396.7** (381)  
 Serien: 99.3 100.4 101.4 95.6  
 Zähler: 23 15 2 0 0 0 0 0 0 0  
 Innenzehner: 17  
 Weitestе: 748 (25.), 527 (33.), 488 (4.)  
 beste Teiler: 31.1 (27.), 32.0 (28.), 75.3 (26.)  
 Trefferlage: 0.54 mm rechts, 0.32 mm hoch  
 Streuwert: 2.08, horizontal: 2.40, vertikal: 1.71

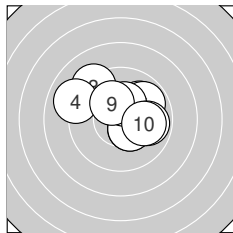
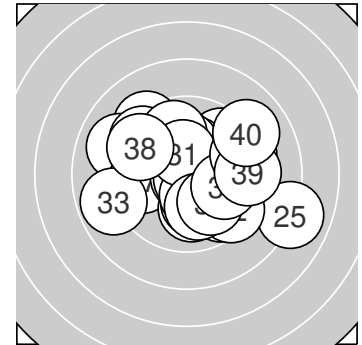

**Serie 1: 99.3 (96)**

10.0 ↗	10.4* ↘	9.2 ↘	9.0 ↖	9.9 ↗
10.4* ↘	10.3* ↑	9.9 →	10.2* ↖	10.0 →

beste Teiler: 133.6 (2.), 135.7 (6.), 158.6 (7.)  
 Trefferlage: 0.33 mm rechts, 0.87 mm hoch  
 Streuwert: 1.97, horizontal: 2.38, vertikal: 1.46

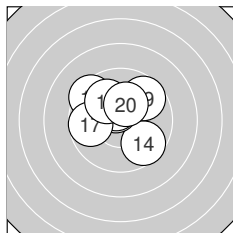

**Serie 2: 100.4 (96)**

9.4 ↘	10.3* ↑	10.3* ↗	9.7 ↘	10.5* ↖
10.5* ↖	9.7 ←	10.0 ↘	9.7 ↗	10.3* ↑

beste Teiler: 108.6 (15.), 125.9 (16.), 163.6 (13.)  
 Trefferlage: 0.14 mm links, 1.03 mm hoch  
 Streuwert: 1.67, horizontal: 1.90, vertikal: 1.41

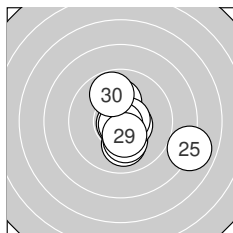

**Serie 3: 101.4 (97)**

10.2* ↑	10.0 ↓	10.2* ↓	10.5* ↗	8.0 ↗
10.7* →	10.8* ↗	10.8* ↓	10.4* ↓	9.8 ↖

beste Teiler: 31.1 (27.), 32.0 (28.), 75.3 (26.)  
 Trefferlage: 0.86 mm rechts, 0.45 mm tief  
 Streuwert: 2.00, horizontal: 2.21, vertikal: 1.77

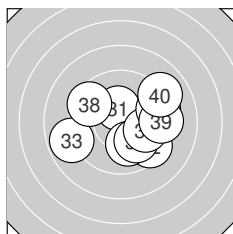

**Serie 4: 95.6 (92)**

10.4* ↑	9.4 ↘	8.8 ←	10.0 ↓	10.0 ↘
9.9 →	9.3 →	9.5 ↖	9.3 →	9.0 ↗

beste Teiler: 143.5 (31.), 230.8 (34.), 244.0 (35.)  
 Trefferlage: 1.13 mm rechts, 0.16 mm tief  
 Streuwert: 2.57, horizontal: 3.11, vertikal: 1.90



Ergebnis: **379.1** (358)  
 Serien: 91.1 95.6 94.7 97.7  
 Zähler: 11 21 7 0 0 0 0 1 0 0 0  
 Innenzehner: 4  
 Weitester: 1765 (1.), 738 (16.), 669 (12.)  
 beste Teiler: 86.9 (25.), 111.6 (5.), 116.2 (31.)  
 Trefferlage: 0.83 mm rechts, 0.93 mm tief  
 Streuwert: 3.15, horizontal: 4.08, vertikal: 1.79

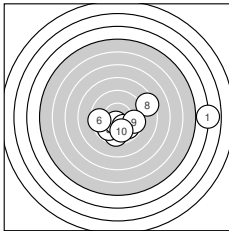
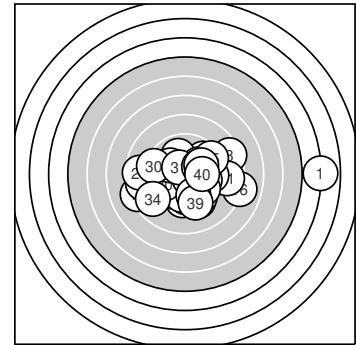

**Serie 1: 91.1 (85)**

3.9 →	9.6 ↓	9.8 ↙	9.8 ↘	10.5* ↓
9.5 ←	10.1 ↘	8.4 →	9.6 →	9.9 ↓

beste Teiler: 111.6 (5.), 204.1 (7.), 268.4 (10.)  
 Trefferlage: 2.45 mm rechts, 1.18 mm tief  
 Streuwert: 4.35, horizontal: 5.93, vertikal: 1.65

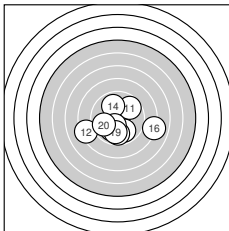

**Serie 2: 95.6 (90)**

9.7 ↗	8.3 ←	9.9 ↘	9.9 ↖	9.7 ↓
8.0 →	10.0 ↙	10.4* ↓	9.9 ↓	9.8 ↙

beste Teiler: 147.8 (18.), 249.3 (17.), 254.6 (14.)  
 Trefferlage: 0.10 mm links, 1.30 mm tief  
 Streuwert: 2.78, horizontal: 3.43, vertikal: 1.94

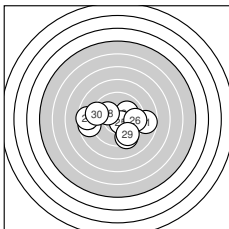

**Serie 3: 94.7 (90)**

8.7 →	9.4 ↘	8.7 ←	10.1 ↗	10.6* ↘
9.6 →	8.6 ←	10.1 ↖	9.6 ↘	9.3 ←

beste Teiler: 86.9 (25.), 221.4 (24.), 222.4 (28.)  
 Trefferlage: 0.23 mm links, 0.52 mm tief  
 Streuwert: 2.99, horizontal: 3.90, vertikal: 1.64

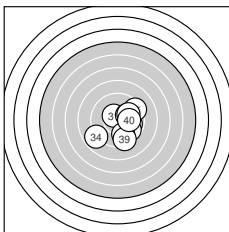

**Serie 4: 97.7 (93)**

10.5* ↖	10.1 ↗	9.9 →	8.8 ↙	9.4 ↗
9.7 ↘	9.8 ↓	10.0 →	9.4 ↘	10.1 →

beste Teiler: 116.2 (31.), 207.5 (32.), 224.0 (40.)  
 Trefferlage: 1.20 mm rechts, 0.72 mm tief  
 Streuwert: 2.12, horizontal: 2.19, vertikal: 2.05



Ergebnis: **595.8** (565)  
 Serien: 100.6 99.8 98.5 98.7 98.4 99.8  
 Zähler: 27 31 2 0 0 0 0 0 0 0  
 Innenzehner: 23  
 Weitester: 523 (34.), 519 (26.), 492 (33.)  
 beste Teiler: 38.9 (57.), 39.8 (46.), 41.4 (25.)  
 Trefferlage: 0.13 mm rechts, 0.16 mm tief  
 Streuwert: 2.04, horizontal: 2.35, vertikal: 1.66

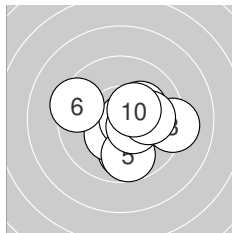
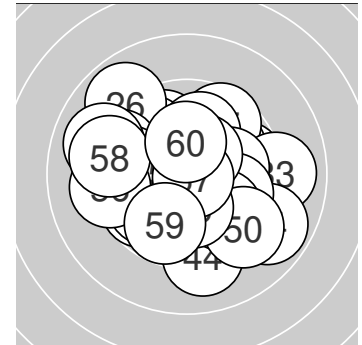

**Serie 1: 100.6 (96)**

9.9 ↓	10.4* ↙	9.2 →	10.8* →	9.8 ↓
9.4 ↖	10.5* ↘	10.2* ↗	10.0 →	10.4* ↗

beste Teiler: 46.5 (4.), 119.7 (7.), 136.4 (10.)  
 Trefferlage: 0.74 mm rechts, 0.50 mm tief  
 Streuwert: 1.76, horizontal: 2.05, vertikal: 1.42

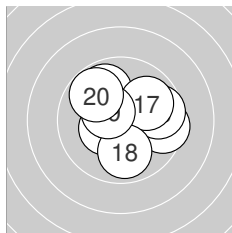

**Serie 2: 99.8 (94)**

9.5 →	10.4* ↙	9.7 →	10.0 ↖	10.2* ↖
9.9 ↖	9.9 ↗	9.9 ↓	10.5* ↖	9.8 ↖

beste Teiler: 125.9 (19.), 140.4 (12.), 181.2 (15.)  
 Trefferlage: 0.09 mm rechts, 0.68 mm hoch  
 Streuwert: 1.83, horizontal: 2.07, vertikal: 1.54

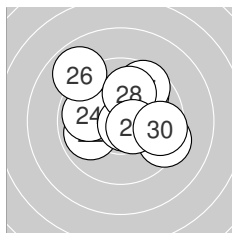

**Serie 3: 98.5 (92)**

9.9 ↗	9.9 ↙	9.4 →	9.9 ↖	10.8* ↘
8.9 ↖	9.6 ↗	10.0 ↑	10.5* →	9.6 →

beste Teiler: 41.4 (25.), 111.8 (29.), 241.9 (28.)  
 Trefferlage: 0.41 mm rechts, 0.78 mm hoch  
 Streuwert: 2.19, horizontal: 2.47, vertikal: 1.86

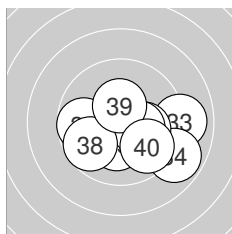

**Serie 4: 98.7 (94)**

10.5* ↙	9.7 ↖	9.0 →	8.9 ↘	10.2* ↓
10.2* →	10.3* →	9.7 ↙	10.4* ↑	9.8 ↘

beste Teiler: 106.9 (31.), 136.2 (39.), 151.1 (37.)  
 Trefferlage: 0.79 mm rechts, 0.86 mm tief  
 Streuwert: 2.09, horizontal: 2.69, vertikal: 1.21

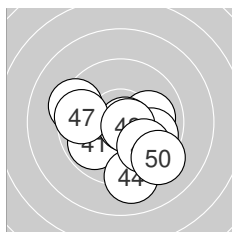

**Serie 5: 98.4 (93)**

9.9 ↙	10.0 →	9.9 →	9.1 ↓	9.4 ↖
10.8* →	9.6 ↖	10.7* →	9.8 ↘	9.2 ↘

beste Teiler: 39.8 (46.), 68.4 (48.), 233.7 (42.)  
 Trefferlage: 0.25 mm rechts, 1.05 mm tief  
 Streuwert: 2.15, horizontal: 2.48, vertikal: 1.77

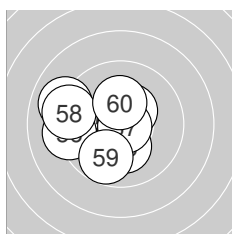

**Serie 6: 99.8 (96)**

9.0 ↖	10.5* ↙	10.5* ↖	10.4* ↗	10.2* ↓
9.2 ↖	10.8* ↘	9.2 ↖	9.8 ↙	10.2* ↑

beste Teiler: 38.9 (57.), 104.6 (53.), 106.5 (52.)  
 Trefferlage: 1.46 mm links, 0.06 mm tief  
 Streuwert: 1.83, horizontal: 2.11, vertikal: 1.50



Ergebnis: **602.8** (574)  
 Serien: 101.2 103.4 98.5 99.8 99.6 100.3  
 Zähler: 36 22 2 0 0 0 0 0 0 0  
 Innenzehner: 29  
 Weitester: 703 (26.), 521 (59.), 484 (36.)  
 beste Teiler: 43.3 (11.), 50.9 (53.), 63.8 (19.)  
 Trefferlage: 0.70 mm rechts, 0.64 mm tief  
 Streuwert: 1.72, horizontal: 1.83, vertikal: 1.61

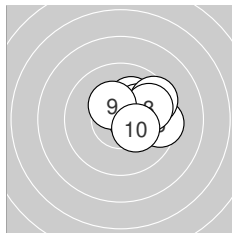
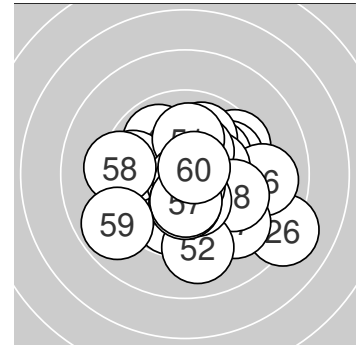

**Serie 1: 101.2 (97)**

10.4* ↑	10.5* →	10.5* →	10.2* ↑	9.5 →
10.2* ↗	9.5 ↗	9.8 ↗	10.3* ↘	10.3* ↘

beste Teiler: 110.2 (3.), 111.0 (2.), 141.2 (1.)  
 Trefferlage: 1.52 mm rechts, 0.72 mm hoch  
 Streuwert: 1.14, horizontal: 1.32, vertikal: 0.92

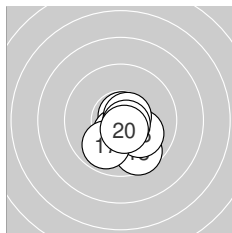

**Serie 2: 103.4 (98)**

10.8* ↑	10.0 ↘	9.6 ↘	10.5* ↓	10.5* ↘
10.1 ↘	9.9 ↘	10.7* ↗	10.7* ↘	10.6* ↘

beste Teiler: 43.3 (11.), 63.8 (19.), 72.0 (18.)  
 Trefferlage: 0.52 mm rechts, 1.09 mm tief  
 Streuwert: 1.02, horizontal: 0.95, vertikal: 1.08

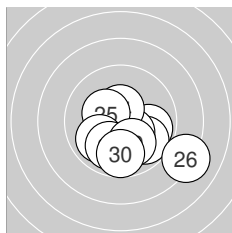

**Serie 3: 98.5 (93)**

9.9 →	9.8 ↘	10.4* ↘	10.5* ↑	10.3* ↘
8.1 ↘	9.9 ↗	9.9 ↘	10.0 ↘	9.7 ↓

beste Teiler: 116.0 (24.), 140.1 (23.), 156.1 (25.)  
 Trefferlage: 0.85 mm rechts, 1.40 mm tief  
 Streuwert: 1.99, horizontal: 2.38, vertikal: 1.50

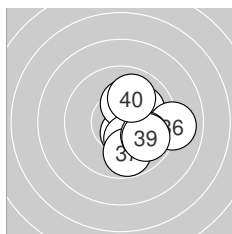

**Serie 4: 99.8 (96)**

10.0 →	10.1 ↗	10.5* ↓	10.3* ↑	10.3* ↘
9.0 →	9.8 ↓	9.9 ↘	9.9 ↘	10.0 ↑

beste Teiler: 106.5 (33.), 167.9 (35.), 174.5 (34.)  
 Trefferlage: 1.65 mm rechts, 0.29 mm tief  
 Streuwert: 1.51, horizontal: 1.38, vertikal: 1.62

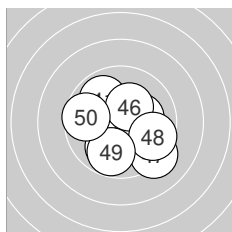

**Serie 5: 99.6 (94)**

9.9 ↘	10.4* ↓	9.9 ↘	10.7* ↓	10.2* →
10.3* ↑	9.2 ↘	9.6 ↘	9.8 ↓	9.6 ←

beste Teiler: 75.7 (44.), 138.2 (42.), 163.9 (46.)  
 Trefferlage: 0.26 mm rechts, 0.69 mm tief  
 Streuwert: 1.90, horizontal: 2.04, vertikal: 1.76

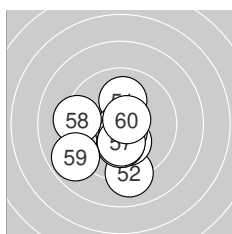

**Serie 6: 100.3 (96)**

10.1 ↑	9.1 ↓	10.8* ↓	10.2* ↓	10.7* ↓
10.2* ↓	10.3* ↓	9.3 ←	8.9 ↘	10.7* ↗

beste Teiler: 50.9 (53.), 70.2 (60.), 74.3 (55.)  
 Trefferlage: 0.58 mm links, 1.09 mm tief  
 Streuwert: 1.91, horizontal: 1.90, vertikal: 1.92

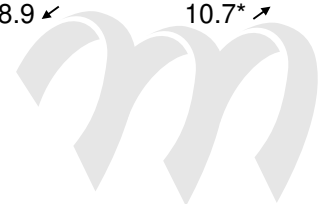

Ergebnis: **614.0** (589)  
 Serien: 103.6 101.9 102.7 102.1 102.0 101.7  
 Zähler: 49 11 0 0 0 0 0 0 0 0  
 Innenzehner: 39  
 Weitestе: 460 (49.), 390 (58.), 332 (6.)  
 beste Teiler: 17.0 (10.), 26.1 (16.), 49.6 (42.)  
 Trefferlage: 0.22 mm rechts, 0.00 mm  
 Streuwert: 1.41, horizontal: 1.52, vertikal: 1.28

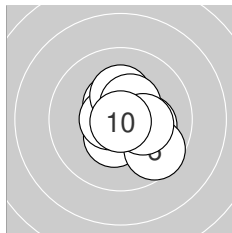
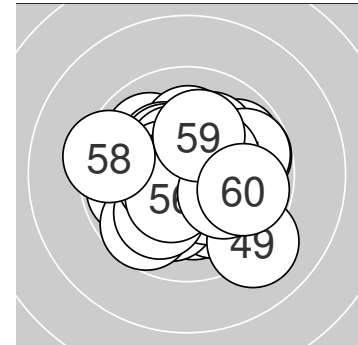

**Serie 1: 103.6 (99)**

10.4* ↑	10.4* ↓	10.5* ↘	10.6* ←	10.2* →
9.6 ↘	10.3* ↑	10.4* ↗	10.3* →	10.9* ↓

beste Teiler: 17.0 (10.), 79.0 (4.), 118.9 (3.)  
 Trefferlage: 0.48 mm rechts, 0.06 mm hoch  
 Streuwert: 1.19, horizontal: 1.14, vertikal: 1.23

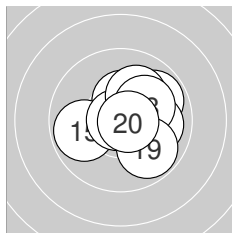

**Serie 2: 101.9 (97)**

9.8 ↗	10.4* →	10.4* ↑	10.0 →	9.8 ←
10.8* ←	10.1 ↗	10.1 ↗	9.8 ↘	10.7* →

beste Teiler: 26.1 (16.), 56.0 (20.), 132.1 (12.)  
 Trefferlage: 0.86 mm rechts, 0.29 mm hoch  
 Streuwert: 1.36, horizontal: 1.53, vertikal: 1.17

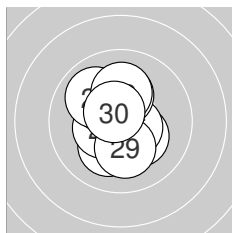

**Serie 3: 102.7 (99)**

10.3* ↘	10.2* ↓	10.4* ←	10.2* ↘	10.6* ↘
9.9 ↘	10.2* ↑	10.1 ↑	10.2* ↓	10.6* ↘

beste Teiler: 82.6 (30.), 94.8 (25.), 136.7 (23.)  
 Trefferlage: 0.30 mm links, 0.20 mm hoch  
 Streuwert: 1.31, horizontal: 1.01, vertikal: 1.55

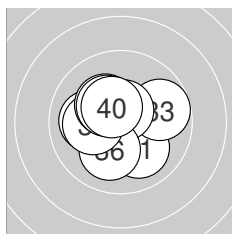

**Serie 4: 102.1 (99)**

10.0 ↘	10.0 ←	9.8 →	10.5* ←	10.6* ↑
10.1 ↓	10.1 ←	10.3* ↘	10.3* ↘	10.4* ↘

beste Teiler: 87.8 (35.), 101.5 (34.), 127.7 (40.)  
 Trefferlage: 0.44 mm links, 0.09 mm hoch  
 Streuwert: 1.39, horizontal: 1.54, vertikal: 1.22

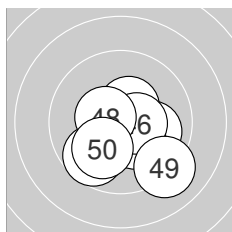

**Serie 5: 102.0 (98)**

10.6* ↓	10.8* ↘	10.0 →	10.5* ↑	10.3* ↘
10.5* →	9.7 ↓	10.5* ←	9.1 ↘	10.0 ↓

beste Teiler: 49.6 (42.), 87.8 (41.), 116.6 (48.)  
 Trefferlage: 0.38 mm rechts, 0.85 mm tief  
 Streuwert: 1.51, horizontal: 1.63, vertikal: 1.38

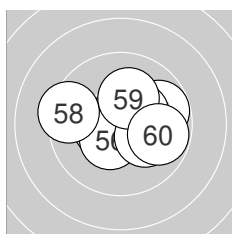

**Serie 6: 101.7 (97)**

9.8 ↗	10.5* ←	10.5* ↗	10.3* ↗	10.6* ←
10.4* ↓	10.2* ↘	9.4 ←	10.2* ↑	9.8 →

beste Teiler: 88.0 (55.), 112.5 (53.), 123.4 (52.)  
 Trefferlage: 0.34 mm rechts, 0.19 mm hoch  
 Streuwert: 1.60, horizontal: 2.04, vertikal: 0.98



Ergebnis: **607.1** (582)  
 Serien: 100.4 102.7 99.8 100.1 100.7 103.4  
 Zähler: 42 18 0 0 0 0 0 0 0 0  
 Innenzehner: 31  
 Weitestе: 461 (37.), 390 (32.), 385 (23.)  
 beste Teiler: 54.5 (4.), 56.1 (60.), 79.8 (2.)  
 Trefferlage: 0.00 mm , 0.24 mm hoch  
 Streuwert: 1.63, horizontal: 1.77, vertikal: 1.47

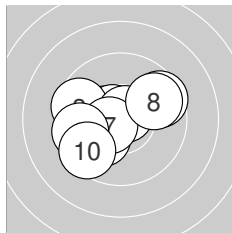
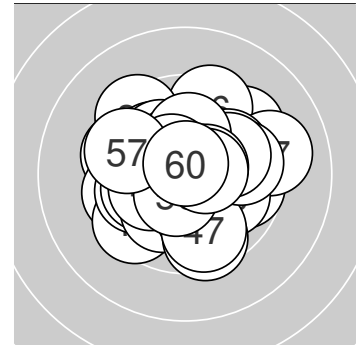

**Serie 1: 100.4 (95)**

10.4* ←	10.6* ↘	9.6 ←	10.7* ↗	10.1 ✓
9.6 ↗	10.5* ✓	9.8 ↗	9.6 ←	9.5 ✓

beste Teiler: 54.5 (4.), 79.8 (2.), 101.1 (7.)  
 Trefferlage: 0.73 mm links, 0.01 mm tief  
 Streuwert: 1.82, horizontal: 2.22, vertikal: 1.32

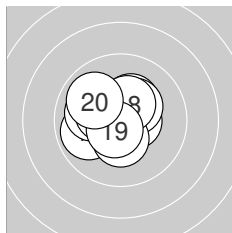

**Serie 2: 102.7 (98)**

9.9 ←	10.3* ↗	10.5* →	10.0 ←	10.3* ↗
10.4* ←	10.4* ↓	10.4* ↗	10.6* ✓	9.9 ↘

beste Teiler: 86.8 (19.), 103.1 (13.), 138.5 (18.)  
 Trefferlage: 0.51 mm links, 0.33 mm hoch  
 Streuwert: 1.25, horizontal: 1.42, vertikal: 1.07

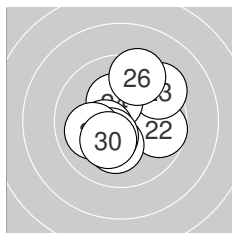

**Serie 3: 99.8 (96)**

9.7 ↗	9.7 →	9.4 ↗	10.3* ↖	10.2* ↓
9.5 ↗	10.4* ✓	10.4* ✓	10.0 ←	10.2* ✓

beste Teiler: 136.9 (27.), 145.6 (28.), 159.7 (24.)  
 Trefferlage: 0.25 mm rechts, 0.36 mm hoch  
 Streuwert: 1.90, horizontal: 1.82, vertikal: 1.98

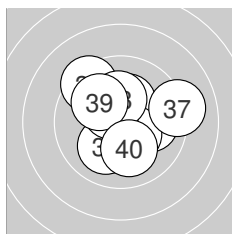

**Serie 4: 100.1 (98)**

10.0 →	9.4 ↘	10.3* ↗	10.4* ↘	10.1 ✓
10.5* ↘	9.1 →	10.2* ↑	10.0 ↘	10.1 ↓

beste Teiler: 116.3 (36.), 138.6 (34.), 167.2 (33.)  
 Trefferlage: 0.27 mm rechts, 0.49 mm hoch  
 Streuwert: 1.87, horizontal: 2.04, vertikal: 1.69

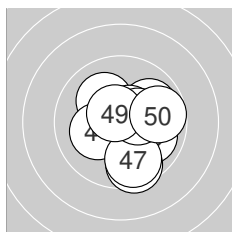

**Serie 5: 100.7 (96)**

9.9 ↗	10.1 ↘	10.0 →	10.2* ✓	10.6* ↗
9.5 ↓	9.7 ↓	10.4* →	10.6* ↘	9.7 →

beste Teiler: 83.2 (49.), 94.7 (45.), 142.9 (48.)  
 Trefferlage: 0.80 mm rechts, 0.28 mm tief  
 Streuwert: 1.64, horizontal: 1.56, vertikal: 1.72

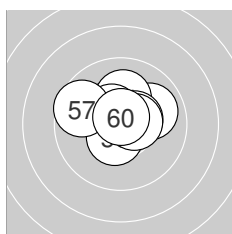

**Serie 6: 103.4 (99)**

10.0 ↗	10.6* ✓	10.4* ↘	10.1 ↑	10.5* ↘
10.5* ✓	9.6 ←	10.5* →	10.5* →	10.7* ↑

beste Teiler: 56.1 (60.), 91.7 (52.), 109.3 (59.)  
 Trefferlage: 0.05 mm links, 0.57 mm hoch  
 Streuwert: 1.21, horizontal: 1.42, vertikal: 0.95

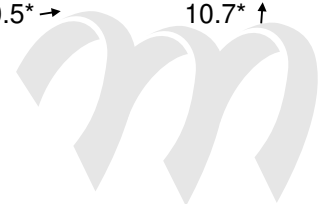

Ergebnis: **614.0** (587)  
 Serien: 103.4 102.3 103.0 102.0 101.5 101.8  
 Zähler: 47 13 0 0 0 0 0 0 0 0  
 Innenzehner: 37  
 Weitester: 497 (57.), 361 (40.), 349 (30.)  
 beste Teiler: 33.9 (20.), 40.4 (23.), 46.1 (39.)  
 Trefferlage: 0.31 mm rechts, 0.42 mm hoch  
 Streuwert: 1.40, horizontal: 1.52, vertikal: 1.26

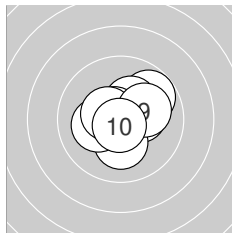
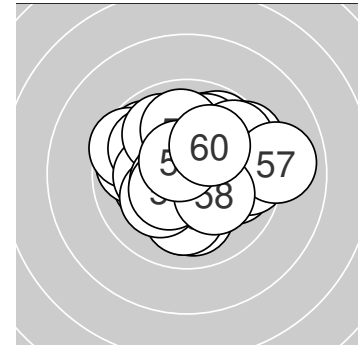

**Serie 1: 103.4 (99)**

9.8 ↗	10.3* ↗	10.6* →	10.3* →	10.2* ↓
10.7* ↘	10.2* ←	10.5* ↘	10.1 →	10.7* ↓

beste Teiler: 52.1 (10.), 69.4 (6.), 87.8 (3.)  
 Trefferlage: 0.40 mm rechts, 0.23 mm hoch  
 Streuwert: 1.21, horizontal: 1.35, vertikal: 1.05

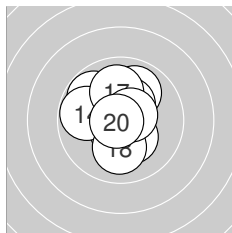

**Serie 2: 102.3 (97)**

9.9 ↗	9.8 ↘	10.6* ↘	9.8 ←	10.3* ↘
10.4* ↗	10.0 ↑	10.1 ↓	10.6* →	10.8* ←

beste Teiler: 33.9 (20.), 82.7 (13.), 93.4 (19.)  
 Trefferlage: 0.26 mm links, 0.43 mm hoch  
 Streuwert: 1.45, horizontal: 1.32, vertikal: 1.56

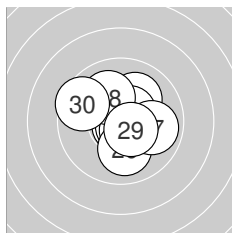

**Serie 3: 103.0 (98)**

10.1 ↗	10.6* ↗	10.8* ↓	10.8* ↓	10.6* ↘
10.0 ↓	9.9 →	10.1 ↘	10.5* ↘	9.6 ↘

beste Teiler: 40.4 (23.), 46.8 (24.), 89.8 (25.)  
 Trefferlage: 0.19 mm rechts, 0.08 mm hoch  
 Streuwert: 1.43, horizontal: 1.51, vertikal: 1.35

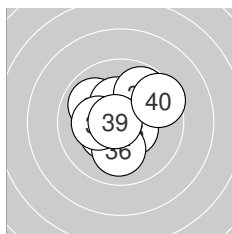

**Serie 4: 102.0 (97)**

10.5* ↘	9.9 ↘	10.5* ↘	10.3* ↑	10.4* ↗
10.1 ↓	9.8 ↗	10.2* ←	10.8* ←	9.5 ↗

beste Teiler: 46.1 (39.), 105.6 (33.), 106.7 (31.)  
 Trefferlage: 0.08 mm links, 0.43 mm hoch  
 Streuwert: 1.52, horizontal: 1.61, vertikal: 1.43

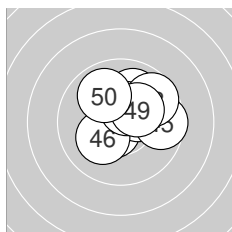

**Serie 5: 101.5 (97)**

10.4* ↗	10.6* ↗	10.3* →	10.0 ↗	9.6 →
10.2* ↗	10.5* ↗	9.7 ↗	10.3* →	9.9 ↘

beste Teiler: 97.3 (42.), 123.0 (47.), 135.7 (41.)  
 Trefferlage: 0.78 mm rechts, 0.78 mm hoch  
 Streuwert: 1.40, horizontal: 1.58, vertikal: 1.19

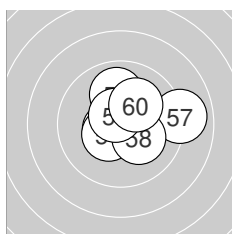

**Serie 6: 101.8 (99)**

10.5* ←	10.2* →	10.3* ↗	10.4* ↗	10.0 ↑
10.5* ↗	9.0 →	10.2* ↘	10.6* ↘	10.1 ↗

beste Teiler: 84.2 (59.), 101.6 (51.), 123.9 (56.)  
 Trefferlage: 0.84 mm rechts, 0.58 mm hoch  
 Streuwert: 1.47, horizontal: 1.75, vertikal: 1.12





# LG 60 ZR

StandNr: 116

Gisser, Elisabeth #656

# Frauen

Wertung

StartNr: 145

11.02.2024 14:12

SG\_Lienz\_SSV

Ergebnis: **596.6** (573)  
 Serien: 99.8 100.1 99.9 98.5 97.9 100.4  
 Zähler: 37 19 4 0 0 0 0 0 0 0  
 Innenzehner: 28  
 Weitester: 733 (34.), 637 (46.), 582 (26.)  
 beste Teiler: 16.9 (52.), 33.8 (14.), 51.1 (8.)  
 Trefferlage: 0.70 mm rechts, 0.62 mm hoch  
 Streuwert: 2.00, horizontal: 2.41, vertikal: 1.48

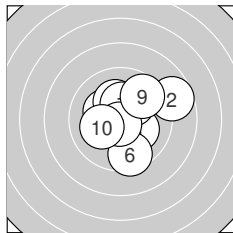
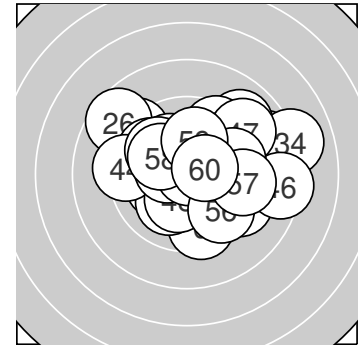

### Serie 1: 99.8 (96)

10.2\* ↖ 8.7 → 10.2\* ↘ 10.2\* ↗ 10.2\* ↗  
 9.5 ↓ 10.3\* ↑ 10.7\* ↓ 9.7 ↗ 10.1 ↖  
 beste Teiler: 51.1 (8.), 153.8 (7.), 176.2 (1.)  
 Trefferlage: 0.73 mm rechts, 0.42 mm hoch  
 Streuwert: 1.96, horizontal: 2.06, vertikal: 1.85

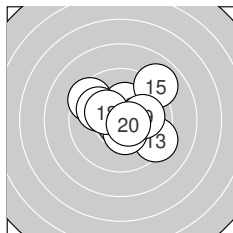

### Serie 2: 100.1 (96)

9.5 ↖ 10.3\* ↑ 9.3 ↘ 10.8\* ↓ 9.0 ↗  
 10.4\* ↓ 9.9 ↖ 10.3\* ↖ 10.0 → 10.6\* ↘  
 beste Teiler: 33.8 (14.), 87.6 (20.), 132.2 (16.)  
 Trefferlage: 0.41 mm rechts, 0.55 mm hoch  
 Streuwert: 1.97, horizontal: 2.27, vertikal: 1.62

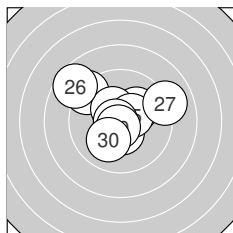

### Serie 3: 99.9 (96)

10.2\* ↗ 9.2 ↖ 10.5\* ↓ 10.4\* ↖ 10.5\* ↗  
 8.6 ↖ 9.0 → 10.7\* ← 10.7\* ↓ 10.1 ↗  
 beste Teiler: 52.0 (28.), 64.6 (29.), 119.0 (23.)  
 Trefferlage: 0.34 mm links, 0.76 mm hoch  
 Streuwert: 2.18, horizontal: 2.55, vertikal: 1.74

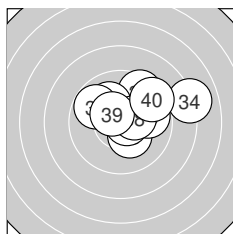

### Serie 4: 98.5 (94)

9.5 ↗ 10.1 ↖ 10.3\* ↘ 8.0 → 9.8 ↖  
 9.8 → 10.7\* → 10.4\* → 10.5\* ↖ 9.4 ↗  
 beste Teiler: 65.5 (37.), 119.5 (39.), 146.7 (38.)  
 Trefferlage: 1.33 mm rechts, 1.12 mm hoch  
 Streuwert: 2.11, horizontal: 2.67, vertikal: 1.32

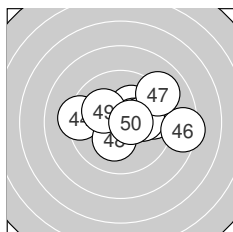

### Serie 5: 97.9 (95)

10.2\* ↗ 10.4\* → 9.6 → 9.3 ← 10.1 →  
 8.4 → 9.1 ↗ 10.2\* ↓ 10.1 ↖ 10.5\* →  
 beste Teiler: 104.0 (50.), 136.1 (42.), 181.2 (48.)  
 Trefferlage: 1.25 mm rechts, 0.44 mm hoch  
 Streuwert: 2.27, horizontal: 2.96, vertikal: 1.24

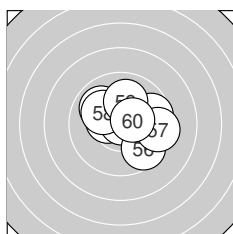

### Serie 6: 100.4 (96)

10.4\* ↖ 10.9\* ↗ 10.0 → 9.9 ↖ 9.7 →  
 9.6 ↘ 9.4 → 10.1 ↖ 10.0 ↑ 10.4\* →  
 beste Teiler: 16.9 (52.), 127.7 (60.), 134.3 (51.)  
 Trefferlage: 0.82 mm rechts, 0.45 mm hoch  
 Streuwert: 1.71, horizontal: 2.05, vertikal: 1.28

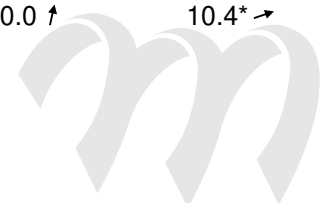

Ergebnis: **619.1** (592)  
 Serien: 100.4 103.4 105.2 104.1 104.5 101.5  
 Zähler: 53 6 1 0 0 0 0 0 0 0  
 Innenzehner: 49  
 Weitester: 521 (10.), 453 (56.), 449 (7.)  
 beste Teiler: 0.0 (27.), 13.9 (50.), 21.0 (28.)  
 Trefferlage: 0.01 mm rechts, 0.05 mm tief  
 Streuwert: 1.36, horizontal: 1.52, vertikal: 1.19

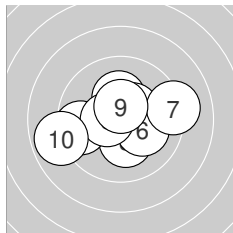
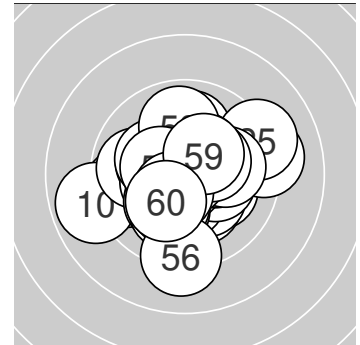

**Serie 1: 100.4 (96)**

10.6\* ↗ 10.2\* ↑ 10.2\* ↓ 10.5\* ↗ 9.6 ←  
 10.2\* ↘ 9.2 → 10.5\* ← 10.5\* ↑ 8.9 ←

beste Teiler: 100.4 (1.), 107.0 (9.), 112.0 (8.)  
 Trefferlage: 0.13 mm links, 0.04 mm hoch  
 Streuwert: 2.03, horizontal: 2.60, vertikal: 1.22

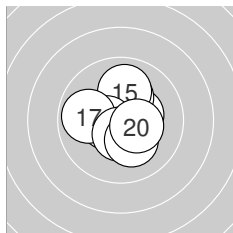

**Serie 2: 103.4 (99)**

10.4\* → 10.2\* ↑ 10.6\* ↑ 10.7\* → 10.0 ↑  
 10.5\* ← 9.9 ← 10.5\* ↓ 10.2\* ↘ 10.4\* ↘

beste Teiler: 62.2 (14.), 86.1 (13.), 116.7 (18.)  
 Trefferlage: 0.12 mm rechts, 0.24 mm hoch  
 Streuwert: 1.24, horizontal: 1.23, vertikal: 1.25

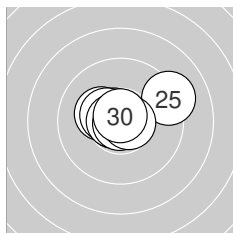

**Serie 3: 105.2 (99)**

10.6\* ↘ 10.3\* ↖ 10.7\* ← 10.4\* ↖ 9.2 →  
 10.7\* ← 10.9\* → 10.9\* ↓ 10.7\* → 10.8\* ↑

beste Teiler: 0.0 (27.), 21.0 (28.), 45.1 (30.)  
 Trefferlage: 0.00 mm, 0.37 mm hoch  
 Streuwert: 1.18, horizontal: 1.54, vertikal: 0.62

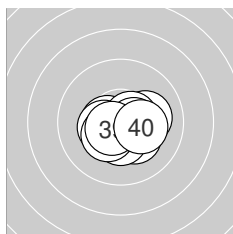

**Serie 4: 104.1 (100)**

10.3\* ↘ 10.4\* ↓ 10.5\* ← 10.4\* ← 10.1 →  
 10.4\* ↗ 10.6\* → 10.5\* → 10.6\* ↗ 10.3\* →

beste Teiler: 88.8 (39.), 90.8 (37.), 110.0 (33.)  
 Trefferlage: 0.26 mm rechts, 0.45 mm tief  
 Streuwert: 0.99, horizontal: 1.26, vertikal: 0.61

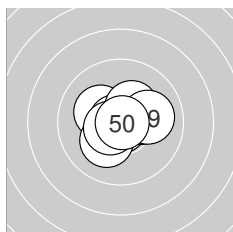

**Serie 5: 104.5 (100)**

10.8\* ↓ 10.3\* → 10.2\* ↖ 10.8\* ← 10.4\* →  
 10.2\* ↗ 10.6\* ↗ 10.3\* ↗ 10.0 → 10.9\* ↘

beste Teiler: 13.9 (50.), 37.1 (41.), 42.2 (44.)  
 Trefferlage: 0.20 mm rechts, 0.09 mm hoch  
 Streuwert: 1.06, horizontal: 1.28, vertikal: 0.77

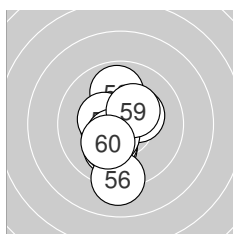

**Serie 6: 101.5 (98)**

10.3\* ↗ 10.5\* ← 9.9 ↑ 10.1 ↓ 10.2\* ↓  
 9.1 ↓ 10.4\* ↖ 10.5\* ↗ 10.3\* ↗ 10.2\* ↓

beste Teiler: 115.5 (52.), 118.9 (58.), 141.7 (57.)  
 Trefferlage: 0.39 mm links, 0.62 mm tief  
 Streuwert: 1.55, horizontal: 0.93, vertikal: 1.99

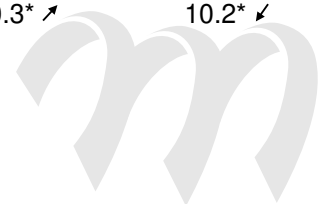

Ergebnis: **604.2** (574)  
 Serien: 98.8 100.9 101.4 102.7 99.2 101.2  
 Zähler: 34 26 0 0 0 0 0 0 0 0  
 Innenzehner: 27  
 Weitester: 455 (8.), 447 (5.), 444 (45.)  
 beste Teiler: 5.3 (43.), 49.0 (39.), 53.3 (14.)  
 Trefferlage: 0.37 mm rechts, 0.36 mm tief  
 Streuwert: 1.73, horizontal: 1.87, vertikal: 1.58

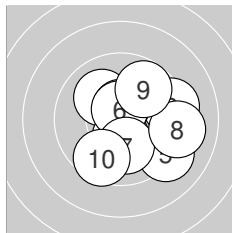
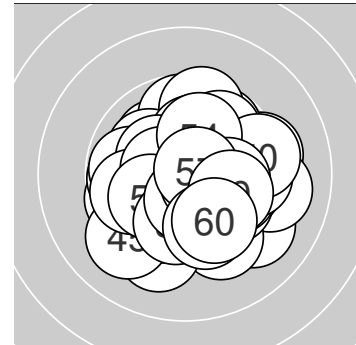

**Serie 1: 98.8 (95)**

10.1 ↘	9.3 →	10.4* ↓	10.6* ↑	9.2 ↘
10.6* ↑	10.1 ↓	9.1 →	9.8 ↗	9.6 ↙

beste Teiler: 80.3 (6.), 92.0 (4.), 138.0 (3.)  
 Trefferlage: 1.12 mm rechts, 0.31 mm tief  
 Streuwert: 2.08, horizontal: 2.21, vertikal: 1.93

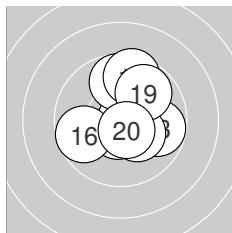

**Serie 2: 100.9 (95)**

10.6* ↓	10.2* →	9.8 →	10.7* →	10.3* ↘
9.7 ←	9.7 ↑	9.5 ↑	9.8 ↗	10.6* ↘

beste Teiler: 53.3 (14.), 87.8 (11.), 91.0 (20.)  
 Trefferlage: 0.63 mm rechts, 0.44 mm hoch  
 Streuwert: 1.67, horizontal: 1.58, vertikal: 1.75

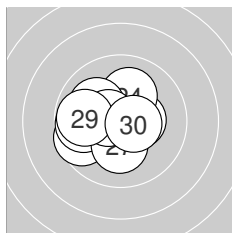

**Serie 3: 101.4 (97)**

10.3* ←	9.6 ←	10.4* →	10.1 ↑	9.8 ←
10.1 ↘	10.2* ↓	10.6* ←	9.8 ←	10.5* →

beste Teiler: 100.1 (28.), 104.1 (30.), 136.2 (23.)  
 Trefferlage: 1.02 mm links, 0.06 mm tief  
 Streuwert: 1.44, horizontal: 1.69, vertikal: 1.13

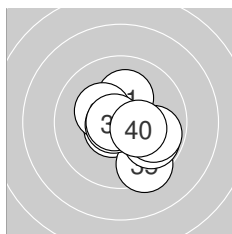

**Serie 4: 102.7 (97)**

10.2* ↑	10.7* ←	10.6* ↙	10.3* ↘	9.4 ↘
9.8 ↘	9.8 ↘	10.7* ←	10.8* ←	10.4* →

beste Teiler: 49.0 (39.), 59.8 (38.), 63.0 (32.)  
 Trefferlage: 0.49 mm rechts, 0.41 mm tief  
 Streuwert: 1.42, horizontal: 1.46, vertikal: 1.38

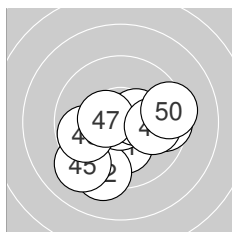

**Serie 5: 99.2 (94)**

10.2* ↓	9.3 ↓	10.9* ↖	10.4* →	9.2 ↙
9.8 ←	10.5* ←	9.6 →	9.9 →	9.4 →

beste Teiler: 5.3 (43.), 119.8 (47.), 129.0 (44.)  
 Trefferlage: 0.30 mm rechts, 0.87 mm tief  
 Streuwert: 2.08, horizontal: 2.44, vertikal: 1.64

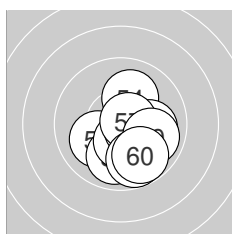

**Serie 6: 101.2 (96)**

10.1 ↙	9.9 ↓	10.4* ↓	10.1 ↑	10.0 →
10.5* →	10.7* →	9.8 ↓	9.9 →	9.8 ↘

beste Teiler: 65.5 (57.), 101.6 (56.), 134.3 (53.)  
 Trefferlage: 0.74 mm rechts, 0.97 mm tief  
 Streuwert: 1.37, horizontal: 1.26, vertikal: 1.47

