

Ergebnis: 189.6 (180)
Serien: 93.5 96.1
Zähler: 8 5 6 1 0 0 0 0 0 0 0
Innenzehner: 6
Weiteste: 838 (8.), 638 (13.), 629 (3.)
beste Teiler: 45.6 (12.), 53.8 (4.), 74.6 (5.)
Trefferlage: 0.82 mm rechts, 0.54 mm tief
Streuwert: 3.05, horizontal: 3.55, vertikal: 2.46

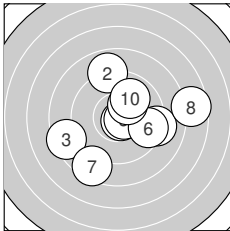
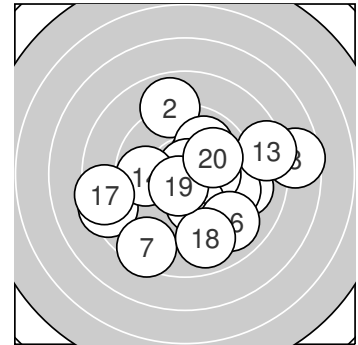

Serie 1: 93.5 (88)

9.1 →	8.9 ↑	8.4 ←	10.7* ↘	10.7* →
9.5 →	8.5 ↙	7.6 →	10.2* ↗	9.9 ↗

beste Teiler: 53.8 (4.), 74.6 (5.), 180.0 (9.)
Trefferlage: 0.99 mm rechts, 0.10 mm tief
Streuwert: 3.41, horizontal: 3.90, vertikal: 2.82

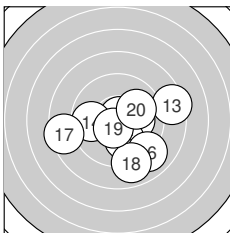

Serie 2: 96.1 (92)

10.2* →	10.8* ↗	8.4 →	9.8 ←	10.0 ↓
9.0 ↘	8.5 ←	8.9 ↓	10.5* ↙	10.0 ↗

beste Teiler: 45.6 (12.), 101.1 (19.), 196.0 (11.)
Trefferlage: 0.65 mm rechts, 0.97 mm tief
Streuwert: 2.80, horizontal: 3.36, vertikal: 2.08



Ergebnis: **175.5** (166)
 Serien: 85.7 89.8
 Zähler: 4 6 4 4 2 0 0 0 0 0 0
 Innenzehner: 3
 Weitestе: 1124 (5.), 1110 (6.), 961 (17.)
 beste Teiler: 53.6 (20.), 120.4 (7.), 154.8 (13.)
 Trefferlage: 0.64 mm rechts, 1.23 mm tief
 Streuwert: 4.46, horizontal: 4.68, vertikal: 4.22

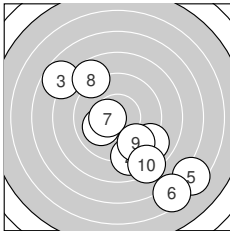
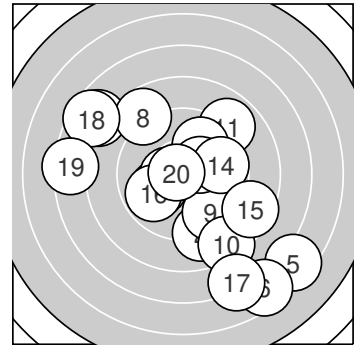

Serie 1: 85.7 (82)

10.0 ↙ 9.0 ↓ 7.7 ↘ 9.0 ↘ 6.5 ↘
 6.5 ↘ 10.5* ← 8.7 ↘ 9.5 ↘ 8.3 ↘
 beste Teiler: 120.4 (7.), 226.2 (1.), 374.4 (9.)
 Trefferlage: 1.31 mm rechts, 2.45 mm tief
 Streuwert: 4.60, horizontal: 4.67, vertikal: 4.52

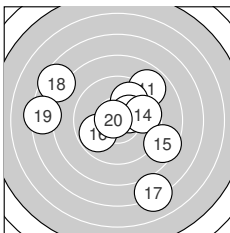

Serie 2: 89.8 (84)

8.9 ↗ 9.9 ↗ 10.3* ↗ 9.7 → 8.5 ↘
 9.8 ↙ 7.1 ↓ 7.5 ↘ 7.4 ← 10.7* ←
 beste Teiler: 53.6 (20.), 154.8 (13.), 267.8 (12.)
 Trefferlage: 0.02 mm links, 0.02 mm tief
 Streuwert: 4.32, horizontal: 4.84, vertikal: 3.73



Ergebnis: **195.4** (188)
 Serien: 98.4 97.0
 Zähler: 10 8 2 0 0 0 0 0 0 0
 Innenzehner: 5
 Weitester: 600 (13.), 583 (1.), 482 (16.)
 beste Teiler: 115.0 (20.), 124.6 (2.), 151.0 (10.)
 Trefferlage: 0.36 mm links, 1.03 mm tief
 Streuwert: 2.23, horizontal: 2.66, vertikal: 1.70

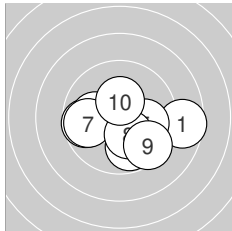
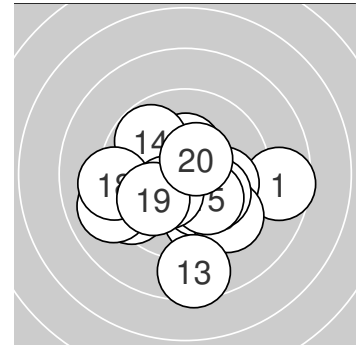

Serie 1: 98.4 (94)

8.6 →	10.5* →	9.7 ←	10.0 ←	10.0 →
9.8 ↓	9.8 ←	10.2* ↓	9.5 ↘	10.3* ↑

beste Teiler: 124.6 (2.), 151.0 (10.), 179.3 (8.)
 Trefferlage: 0.54 mm rechts, 0.77 mm tief
 Streuwert: 2.15, horizontal: 2.78, vertikal: 1.25

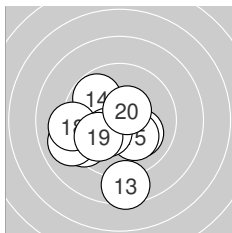

Serie 2: 97.0 (94)

9.4 ↙	10.1 ↘	8.6 ↓	9.8 ↘	10.1 ↘
9.0 ←	10.3* ↙	9.2 ←	10.0 ↙	10.5* ↗

beste Teiler: 115.0 (20.), 156.2 (17.), 201.6 (15.)
 Trefferlage: 1.27 mm links, 1.29 mm tief
 Streuwert: 2.21, horizontal: 2.31, vertikal: 2.10



Ergebnis: **177.5** (168)
 Serien: 92.3 85.2
 Zähler: 6 5 5 2 1 0 0 1 0 0 0
 Innenzehner: 4
 Weitester: 1871 (13.), 1095 (5.), 820 (20.)
 beste Teiler: 77.9 (6.), 92.3 (18.), 160.1 (1.)
 Trefferlage: 0.27 mm rechts, 1.92 mm tief
 Streuwert: 4.59, horizontal: 4.36, vertikal: 4.80

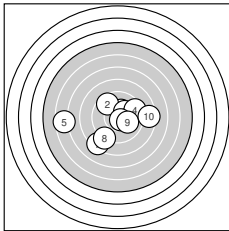
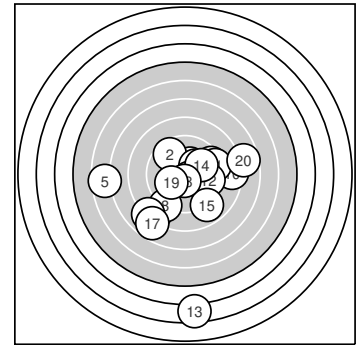

Serie 1: 92.3 (88)

10.3* ↗ 9.6 ↘ 10.2* ↗ 9.4 ↗ 6.6 ←
 10.6* ↘ 8.3 ↙ 8.9 ↙ 10.0 ↘ 8.4 →
 beste Teiler: 77.9 (6.), 160.1 (1.), 183.9 (3.)
 Trefferlage: 0.49 mm links, 0.50 mm tief
 Streuwert: 3.84, horizontal: 4.78, vertikal: 2.58

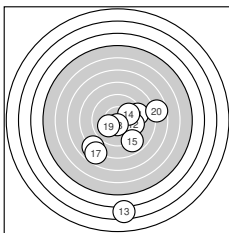

Serie 2: 85.2 (80)

9.2 → 9.6 → 3.5 ↓ 9.9 → 8.9 ↘
 8.0 ↙ 7.7 ↙ 10.6* ↓ 10.1 ← 7.7 →
 beste Teiler: 92.3 (18.), 217.3 (19.), 256.4 (14.)
 Trefferlage: 1.04 mm rechts, 3.34 mm tief
 Streuwert: 5.17, horizontal: 4.00, vertikal: 6.13



Ergebnis: **181.3** (171)
 Serien: 87.4 93.9
 Zähler: 4 8 5 2 0 1 0 0 0 0 0
 Innenzehner: 3
 Weitestе: 1301 (7.), 948 (17.), 777 (8.)
 beste Teiler: 27.4 (19.), 84.8 (18.), 102.9 (16.)
 Trefferlage: 0.91 mm links, 0.53 mm tief
 Streuwert: 3.98, horizontal: 4.86, vertikal: 2.83

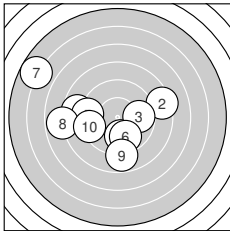
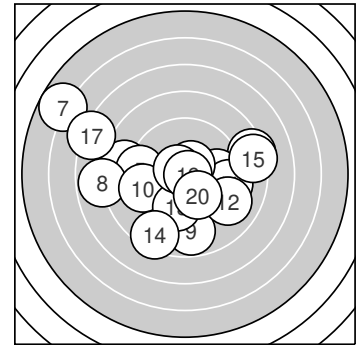

Serie 1: 87.4 (81)

9.9 ↓ 8.3 → 9.8 → 8.7 ← 9.3 ←
 9.8 ↓ 5.7 ↖ 7.8 ← 8.8 ↓ 9.3 ←

beste Teiler: 263.2 (1.), 290.6 (6.), 298.1 (3.)
 Trefferlage: 2.16 mm links, 0.30 mm tief
 Streuwert: 4.38, horizontal: 5.35, vertikal: 3.12

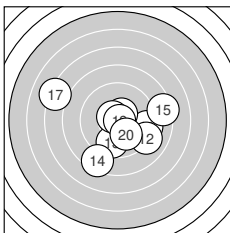

Serie 2: 93.9 (90)

9.3 → 9.1 ↘ 9.7 ↓ 8.4 ↓ 8.3 →
 10.5* ↗ 7.2 ↖ 10.6* ↖ 10.8* → 10.0 ↓

beste Teiler: 27.4 (19.), 84.8 (18.), 102.9 (16.)
 Trefferlage: 0.34 mm rechts, 0.77 mm tief
 Streuwert: 3.52, horizontal: 4.22, vertikal: 2.65



Ergebnis: **188.7** (179)
 Serien: 93.2 95.5
 Zähler: 4 12 3 1 0 0 0 0 0 0
 Innenzehner: 4
 Weitester: 923 (2.), 687 (10.), 649 (19.)
 beste Teiler: 84.0 (6.), 85.1 (12.), 109.4 (11.)
 Trefferlage: 1.12 mm links, 1.66 mm tief
 Streuwert: 2.76, horizontal: 2.97, vertikal: 2.54

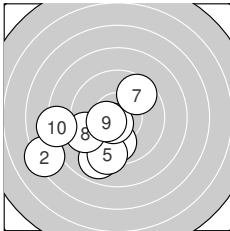
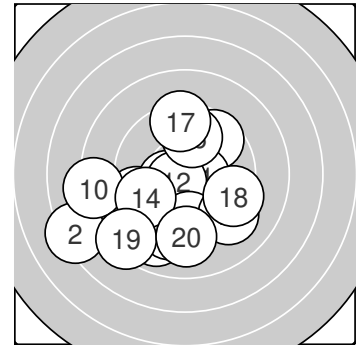

Serie 1: 93.2 (88)

9.8 ↙ 7.3 ↙ 8.9 ↙ 9.8 ↓ 9.2 ↓
 10.6* ↙ 9.6 ↗ 9.4 ↙ 10.4* ↙ 8.2 ↙
 beste Teiler: 84.0 (6.), 133.8 (9.), 278.3 (4.)
 Trefferlage: 2.30 mm links, 1.98 mm tief
 Streuwert: 2.69, horizontal: 3.11, vertikal: 2.20

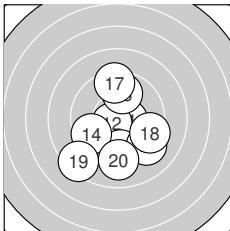

Serie 2: 95.5 (91)

10.5* → 10.6* ↙ 9.5 ↓ 9.6 ↙ 9.2 ↘
 9.8 ↑ 9.4 ↑ 9.4 ↘ 8.4 ↙ 9.1 ↓
 beste Teiler: 85.1 (12.), 109.4 (11.), 279.0 (16.)
 Trefferlage: 0.05 mm rechts, 1.34 mm tief
 Streuwert: 2.69, horizontal: 2.43, vertikal: 2.93



Ergebnis: **201.4** (193)
 Serien: 100.1 101.3
 Zähler: 14 5 1 0 0 0 0 0 0 0
 Innenzehner: 12
 Weitesten: 540 (16.), 488 (8.), 426 (1.)
 beste Teiler: 15.2 (12.), 78.0 (9.), 103.3 (19.)
 Trefferlage: 0.02 mm rechts, 0.25 mm hoch
 Streuwert: 1.87, horizontal: 2.43, vertikal: 1.04

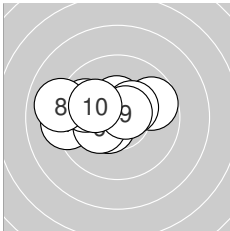
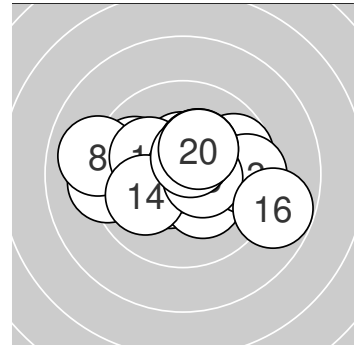

Serie 1: 100.1 (96)

9.2 ←	10.5* ↙	10.5* ↑	9.7 →	10.4* ↗
10.3* ←	9.8 ↖	9.0 ←	10.6* ↗	10.1 ↖

beste Teiler: 78.0 (9.), 111.7 (2.), 125.2 (3.)
 Trefferlage: 1.12 mm links, 0.45 mm hoch
 Streuwert: 1.80, horizontal: 2.40, vertikal: 0.82

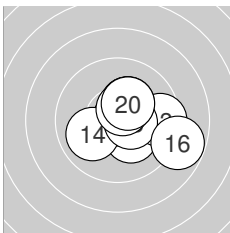

Serie 2: 101.3 (97)

10.2* ↘	10.9* ↗	9.5 →	10.0 ←	10.5* →
8.8 →	10.3* ↗	10.3* ↗	10.5* ↗	10.3* ↗

beste Teiler: 15.2 (12.), 103.3 (19.), 112.7 (15.)
 Trefferlage: 1.18 mm rechts, 0.06 mm hoch
 Streuwert: 1.62, horizontal: 1.94, vertikal: 1.23



Ergebnis: **192.5** (183)
 Serien: 96.8 95.7
 Zähler: 7 10 2 1 0 0 0 0 0 0 0
 Innenzehner: 6
 Weitester: 774 (16.), 645 (13.), 604 (10.)
 beste Teiler: 75.1 (9.), 77.1 (3.), 105.6 (14.)
 Trefferlage: 0.56 mm links, 0.93 mm hoch
 Streuwert: 2.66, horizontal: 3.28, vertikal: 1.83

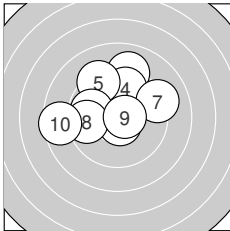
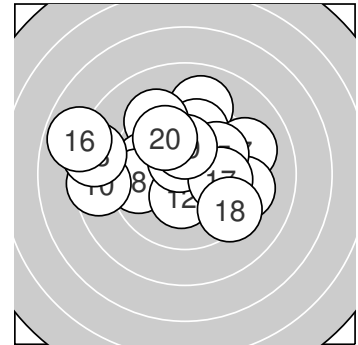

Serie 1: 96.8 (92)

9.1 ↑	10.2* ↖	10.6* ↓	9.7 ↑	9.3 ↖
9.8 ←	9.2 ↗	9.7 ←	10.7* →	8.5 ←

beste Teiler: 75.1 (9.), 77.1 (3.), 180.7 (2.)
 Trefferlage: 0.74 mm links, 1.35 mm hoch
 Streuwert: 2.42, horizontal: 2.84, vertikal: 1.91

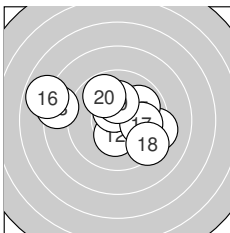

Serie 2: 95.7 (91)

9.3 →	10.3* ↓	8.4 ←	10.5* ↖	9.9 ↗
7.9 ←	10.0 →	9.4 ↘	10.2* ↑	9.8 ↖

beste Teiler: 105.6 (14.), 155.0 (12.), 191.0 (19.)
 Trefferlage: 0.38 mm links, 0.52 mm hoch
 Streuwert: 2.97, horizontal: 3.82, vertikal: 1.75



Ergebnis: **207.5** (198)
 Serien: 103.9 103.6
 Zähler: 18 2 0 0 0 0 0 0 0 0 0
 Innenzehner: 16
 Weitester: 295 (16.), 258 (10.), 242 (7.)
 beste Teiler: 62.0 (15.), 74.7 (3.), 77.8 (4.)
 Trefferlage: 0.68 mm links, 0.25 mm tief
 Streuwert: 1.02, horizontal: 1.19, vertikal: 0.81

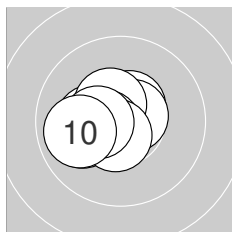
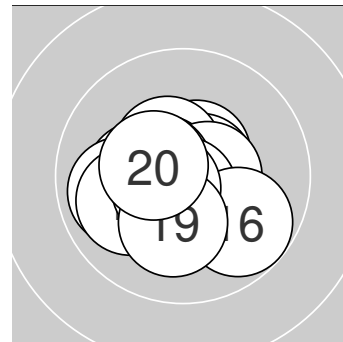

Serie 1: 103.9 (99)

10.5* ↗	10.2* ←	10.7* ↘	10.6* ↗	10.5* ↘
10.5* ←	10.0 ←	10.6* ↓	10.4* ←	9.9 ←

beste Teiler: 74.7 (3.), 77.8 (4.), 92.3 (8.)
 Trefferlage: 0.90 mm links, 0.04 mm hoch
 Streuwert: 0.92, horizontal: 1.11, vertikal: 0.67

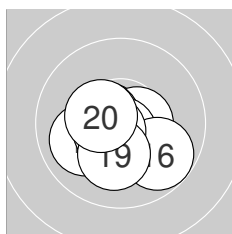

Serie 2: 103.6 (99)

10.6* ←	10.5* →	10.3* ←	10.5* ←	10.7* ↓
9.8 ↘	10.0 ←	10.6* ←	10.2* ↓	10.4* ←

beste Teiler: 62.0 (15.), 84.6 (18.), 88.8 (11.)
 Trefferlage: 0.46 mm links, 0.54 mm tief
 Streuwert: 1.09, horizontal: 1.29, vertikal: 0.85



Ergebnis: **199.3** (189)
 Serien: 98.7 100.6
 Zähler: 10 9 1 0 0 0 0 0 0 0 0
 Innenzehner: 9
 Weitester: 523 (9.), 451 (15.), 427 (7.)
 beste Teiler: 49.0 (1.), 63.6 (12.), 81.9 (19.)
 Trefferlage: 0.65 mm links, 0.08 mm hoch
 Streuwert: 1.96, horizontal: 2.15, vertikal: 1.75

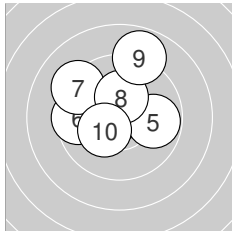
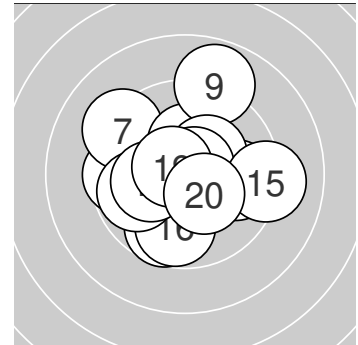

Serie 1: 98.7 (93)

10.8* ←	9.7 ←	9.7 ←	10.4* ←	9.8 →
9.6 ←	9.2 ↘	10.3* ↑	8.9 ↑	10.3* ↙

beste Teiler: 49.0 (1.), 150.0 (4.), 165.3 (10.)
 Trefferlage: 1.15 mm links, 0.95 mm hoch
 Streuwert: 1.98, horizontal: 2.20, vertikal: 1.74

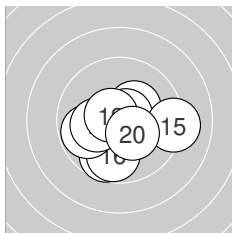

Serie 2: 100.6 (96)

10.3* ↗	10.7* ↗	9.7 ↓	10.1 ←	9.1 →
9.8 ↓	9.8 ←	10.2* ←	10.6* ↘	10.3* ↘

beste Teiler: 63.6 (12.), 81.9 (19.), 152.7 (20.)
 Trefferlage: 0.14 mm links, 0.78 mm tief
 Streuwert: 1.74, horizontal: 2.08, vertikal: 1.31



Ergebnis: **201.6** (191)
 Serien: 100.2 101.4
 Zähler: 11 9 0 0 0 0 0 0 0 0 0
 Innenzehner: 9
 Weitestе: 464 (12.), 365 (9.), 352 (2.)
 beste Teiler: 6.0 (6.), 62.6 (13.), 67.9 (20.)
 Trefferlage: 0.95 mm rechts, 0.12 mm tief
 Streuwert: 1.65, horizontal: 2.01, vertikal: 1.19

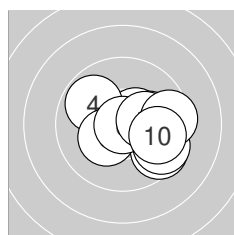
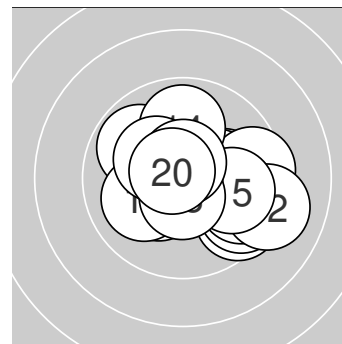

Serie 1: 100.2 (95)

10.5* ↗	9.5 ↘	10.1 →	9.8 ↖	10.3* ↙
10.9* ↓	10.2* →	9.6 ↘	9.5 →	9.8 ↘

beste Teiler: 6.0 (6.), 117.9 (1.), 162.7 (5.)
 Trefferlage: 1.36 mm rechts, 0.23 mm tief
 Streuwert: 1.60, horizontal: 1.97, vertikal: 1.14

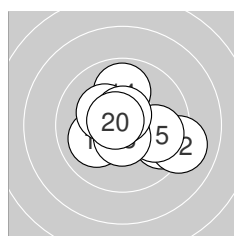

Serie 2: 101.4 (96)

9.6 ↘	9.1 ↘	10.7* ↖	9.9 ↑	9.9 ↘
10.0 ↙	10.3* ↖	10.6* ↓	10.6* ↑	10.7* ↖

beste Teiler: 62.6 (13.), 67.9 (20.), 82.0 (19.)
 Trefferlage: 0.54 mm rechts, 0.01 mm tief
 Streuwert: 1.73, horizontal: 2.07, vertikal: 1.29



Ergebnis: **187.0** (179)
 Serien: 92.7 94.3
 Zähler: 5 9 6 0 0 0 0 0 0 0 0
 Innenzehner: 4
 Weitester: 747 (5.), 643 (12.), 640 (15.)
 beste Teiler: 89.0 (7.), 136.2 (3.), 174.2 (17.)
 Trefferlage: 0.99 mm links, 1.57 mm tief
 Streuwert: 2.92, horizontal: 3.42, vertikal: 2.32

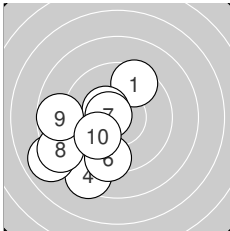
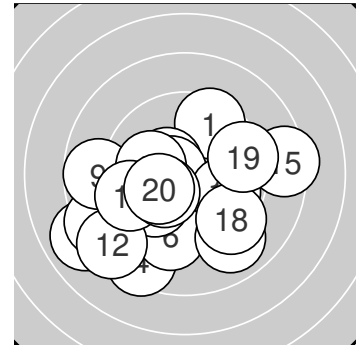

Serie 1: 92.7 (88)

9.5 ↗ 9.2 ↘ 10.4* ↖
 9.4 ↘ 10.6* ← 8.5 ↙

8.5 ↘ 8.0 ↙
 8.7 ← 9.9 ↘

beste Teiler: 89.0 (7.), 136.2 (3.), 260.4 (10.)
 Trefferlage: 2.51 mm links, 1.79 mm tief
 Streuwert: 2.64, horizontal: 2.53, vertikal: 2.75

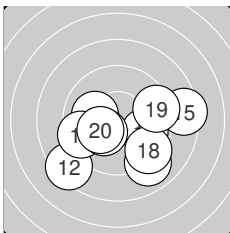

Serie 2: 94.3 (91)

10.1 ← 8.4 ↙ 9.4 ←
 9.8 → 10.3* ↙ 9.3 ↘

9.0 ↘ 8.4 →
 9.4 → 10.2* ↙

beste Teiler: 174.2 (17.), 189.8 (20.), 223.1 (11.)
 Trefferlage: 0.51 mm rechts, 1.35 mm tief
 Streuwert: 2.91, horizontal: 3.63, vertikal: 1.93



Ergebnis: **203.6** (194)
 Serien: 101.5 102.1
 Zähler: 14 6 0 0 0 0 0 0 0 0 0
 Innenzehner: 12
 Weitesten: 466 (10.), 406 (7.), 362 (13.)
 beste Teiler: 3.6 (8.), 8.9 (4.), 42.3 (12.)
 Trefferlage: 1.08 mm links, 0.12 mm tief
 Streuwert: 1.48, horizontal: 1.87, vertikal: 0.94

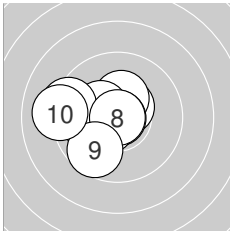
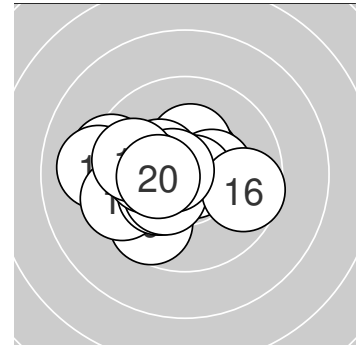

Serie 1: 101.5 (97)

10.5* ↗	10.0 ←	10.3* ↑	10.9* ↓	10.3* ↖
10.5* ↙	9.3 ←	10.9* ↘	9.7 ↘	9.1 ←

beste Teiler: 3.6 (8.), 8.9 (4.), 106.6 (6.)
 Trefferlage: 1.39 mm links, 0.07 mm hoch
 Streuwert: 1.53, horizontal: 1.82, vertikal: 1.15

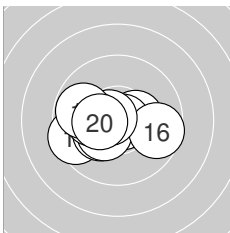

Serie 2: 102.1 (97)

10.4* →	10.8* →	9.5 ←	10.3* ↙	10.4* ↘
9.7 →	10.7* ↖	10.1 ←	9.8 ←	10.4* ←

beste Teiler: 42.3 (12.), 70.8 (17.), 144.5 (20.)
 Trefferlage: 0.77 mm links, 0.32 mm tief
 Streuwert: 1.47, horizontal: 1.97, vertikal: 0.68

