

Ergebnis: **416.6** (398)  
 Serien: 102.7 103.1 105.4 105.4  
 Zähler: 39 0 1 0 0 0 0 0 0 0  
 Innenzehner: 34  
 Weitestе: 521 (20.), 243 (8.), 226 (16.)  
 beste Teiler: 30.0 (25.), 34.6 (14.), 36.0 (39.)  
 Trefferlage: 0.13 mm links, 0.09 mm hoch  
 Streuwert: 1.14, horizontal: 1.26, vertikal: 1.01

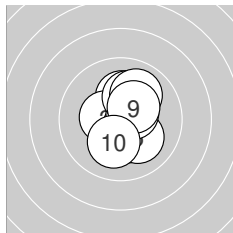
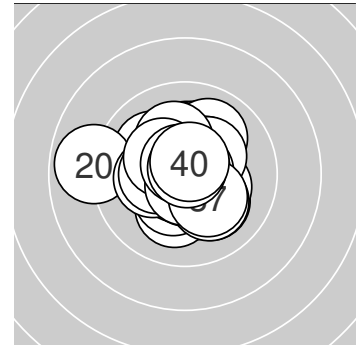

**Serie 1: 102.7 (100)**

10.2* ↑	10.4* ←	10.3* ↓	10.6* ↘	10.1 ↘
10.5* ↗	10.1 ↑	10.0 ↗	10.3* ↗	10.2* ↓

beste Teiler: 96.8 (4.), 112.2 (6.), 129.2 (2.)  
 Trefferlage: 0.50 mm rechts, 0.19 mm hoch  
 Streuwert: 1.24, horizontal: 0.87, vertikal: 1.53

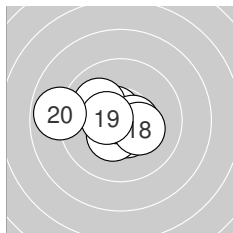

**Serie 2: 103.1 (98)**

10.5* ↓	10.4* ↓	10.6* ←	10.8* ↖	10.6* ↖
10.0 ↖	10.5* →	10.3* ↘	10.5* ←	8.9 ←

beste Teiler: 34.6 (14.), 82.2 (13.), 86.0 (15.)  
 Trefferlage: 0.73 mm links, 0.02 mm hoch  
 Streuwert: 1.44, horizontal: 1.87, vertikal: 0.80

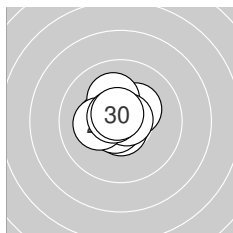

**Serie 3: 105.4 (100)**

10.4* ←	10.3* ↗	10.2* ↑	10.7* ↓	10.8* ↗
10.7* ↗	10.7* →	10.2* ←	10.7* ↖	10.7* ↖

beste Teiler: 30.0 (25.), 53.8 (27.), 67.8 (26.)  
 Trefferlage: 0.36 mm links, 0.24 mm hoch  
 Streuwert: 0.84, horizontal: 0.89, vertikal: 0.78

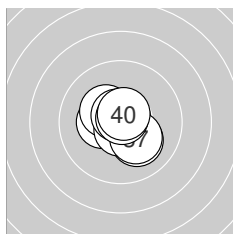

**Serie 4: 105.4 (100)**

10.8* ↓	10.8* ↗	10.1 ↓	10.3* ←	10.3* ↖
10.7* ↓	10.2* ↘	10.7* ↖	10.8* ↑	10.7* ↑

beste Teiler: 36.0 (39.), 43.1 (32.), 50.0 (31.)  
 Trefferlage: 0.05 mm rechts, 0.10 mm tief  
 Streuwert: 0.89, horizontal: 0.93, vertikal: 0.85



Ergebnis: **411.5** (395)  
 Serien: 103.8 101.0 103.2 103.5  
 Zähler: 35 5 0 0 0 0 0 0 0 0  
 Innenzehner: 28  
 Weitestе: 379 (40.), 374 (14.), 345 (19.)  
 beste Teiler: 15.8 (7.), 21.5 (37.), 43.4 (8.)  
 Trefferlage: 0.18 mm rechts, 0.19 mm hoch  
 Streuwert: 1.33, horizontal: 1.55, vertikal: 1.07

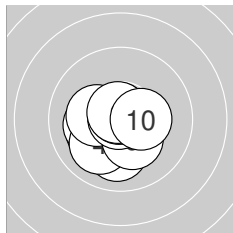
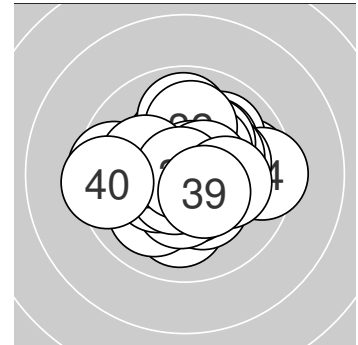

**Serie 1: 103.8 (100)**

10.2* ←	10.2* ←	10.0 ↓	10.0 ↗	10.3* ←
10.3* ↘	10.9* ←	10.8* ↑	10.7* ↘	10.4* →

beste Teiler: 15.8 (7.), 43.4 (8.), 53.3 (9.)  
 Trefferlage: 0.52 mm links, 0.56 mm tief  
 Streuwert: 1.08, horizontal: 1.17, vertikal: 0.99

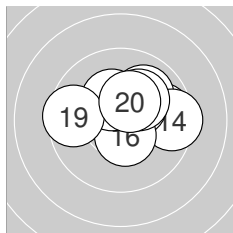

**Serie 2: 101.0 (97)**

9.8 →	10.0 ↗	10.5* ↑	9.5 →	10.3* ↗
10.5* ↘	10.2* ↗	10.3* ↘	9.6 ←	10.3* ↗

beste Teiler: 102.0 (13.), 116.0 (16.), 151.6 (20.)  
 Trefferlage: 0.76 mm rechts, 0.78 mm hoch  
 Streuwert: 1.53, horizontal: 1.98, vertikal: 0.88

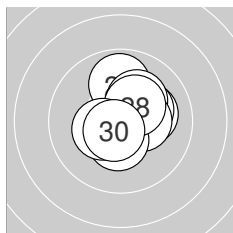

**Serie 3: 103.2 (99)**

10.7* ←	10.1 →	10.2* ↗	9.9 ↑	10.2* ↗
10.4* →	10.4* ↓	10.3* ↗	10.4* ←	10.6* ↗

beste Teiler: 62.0 (21.), 83.8 (30.), 138.3 (27.)  
 Trefferlage: 0.46 mm rechts, 0.38 mm hoch  
 Streuwert: 1.16, horizontal: 1.12, vertikal: 1.20

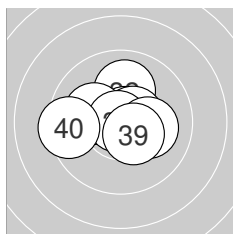

**Serie 4: 103.5 (99)**

10.5* ↘	10.0 ↑	10.8* ↗	10.7* →	10.6* ↗
10.1 ←	10.9* ←	10.1 →	10.4* ↘	9.4 ←

beste Teiler: 21.5 (37.), 48.1 (33.), 74.5 (34.)  
 Trefferlage: 0.02 mm rechts, 0.16 mm hoch  
 Streuwert: 1.33, horizontal: 1.67, vertikal: 0.87



**Ergebnis: 401.0 (382)**  
**Serien: 100.2 103.3 99.6 97.9**  
**Zähler: 24 14 2 0 0 0 0 0 0 0**  
**Innenzehner: 21**  
**Weiteste: 567 (34.), 552 (27.), 474 (32.)**  
**beste Teiler: 31.0 (6.), 35.8 (12.), 49.3 (23.)**  
**Trefferlage: 0.05 mm rechts, 0.57 mm hoch**  
**Streuwert: 1.90, horizontal: 2.47, vertikal: 1.07**

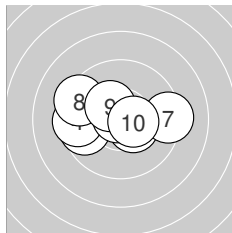
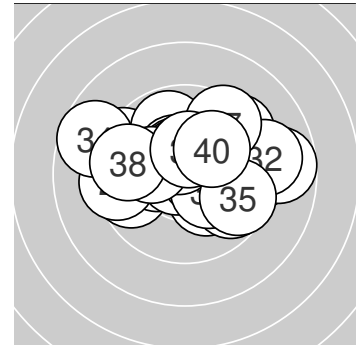

**Serie 1: 100.2 (95)**

9.6 ←	9.9 ←	10.5* ↘	9.4 ←	10.4* ↘
10.8* ↘	9.3 →	9.4 ↘	10.4* ↘	10.5* ↘

**beste Teiler: 31.0 (6.), 110.8 (3.), 113.9 (10.)**  
**Trefferlage: 0.86 mm links, 0.25 mm hoch**  
**Streuwert: 1.88, horizontal: 2.53, vertikal: 0.81**

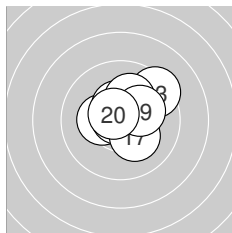

**Serie 2: 103.3 (99)**

10.3* ←	10.8* ↘	9.4 ↗	10.4* ↑	10.6* ↑
10.7* ↖	10.2* ↘	10.1 ↑	10.2* ↗	10.6* ↘

**beste Teiler: 35.8 (12.), 52.3 (16.), 82.0 (15.)**  
**Trefferlage: 0.38 mm rechts, 0.70 mm hoch**  
**Streuwert: 1.20, horizontal: 1.34, vertikal: 1.05**

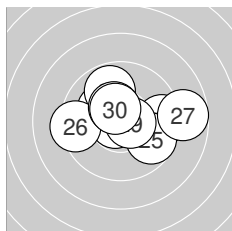

**Serie 3: 99.6 (94)**

9.5 →	10.2* ↘	10.8* ←	9.8 ↑	9.7 ↘
9.4 ←	8.7 →	10.4* ↖	10.6* →	10.5* ↑

**beste Teiler: 49.3 (23.), 88.1 (29.), 118.7 (30.)**  
**Trefferlage: 0.46 mm rechts, 0.43 mm hoch**  
**Streuwert: 2.12, horizontal: 2.78, vertikal: 1.14**

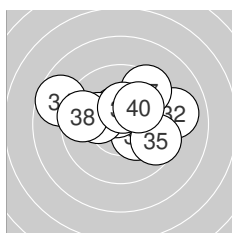

**Serie 4: 97.9 (94)**

10.3* ↘	9.1 →	10.5* ↑	8.7 ↘	9.6 ↘
10.1 ←	9.5 ↗	9.6 ←	10.4* ↑	10.1 ↗

**beste Teiler: 110.6 (33.), 146.5 (39.), 167.8 (31.)**  
**Trefferlage: 0.22 mm rechts, 0.89 mm hoch**  
**Streuwert: 2.34, horizontal: 3.04, vertikal: 1.29**



Ergebnis: **413.2** (394)  
 Serien: 104.8 104.4 104.0 100.0  
 Zähler: 35 4 1 0 0 0 0 0 0 0  
 Innenzehner: 30  
 Weitestе: 567 (33.), 459 (38.), 370 (32.)  
 beste Teiler: 12.5 (5.), 27.6 (35.), 46.2 (28.)  
 Trefferlage: 0.35 mm links, 0.47 mm tief  
 Streuwert: 1.31, horizontal: 1.43, vertikal: 1.18

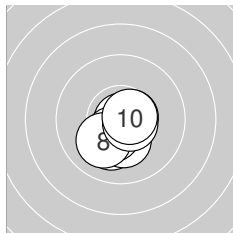
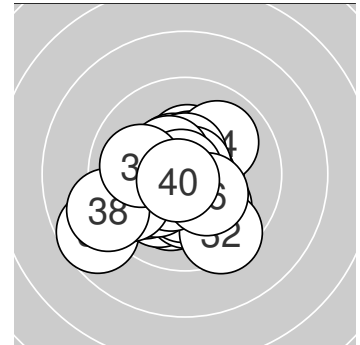

**Serie 1: 104.8 (100)**

10.6* ↓	10.1 ↓	10.6* ↓	10.3* ↓	10.9* ↓
10.4* ↗	10.6* →	10.1 ↗	10.6* →	10.6* →

beste Teiler: 12.5 (5.), 76.6 (10.), 77.2 (3.)  
 Trefferlage: 0.02 mm rechts, 0.81 mm tief  
 Streuwert: 0.77, horizontal: 0.74, vertikal: 0.79

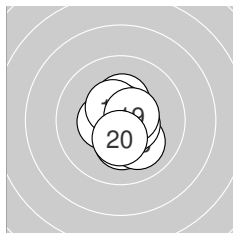

**Serie 2: 104.4 (100)**

10.4* ←	10.2* ↓	10.1 ↘	10.3* ↑	10.7* →
10.7* ↑	10.5* ↖	10.5* →	10.6* →	10.4* ↓

beste Teiler: 66.4 (15.), 68.0 (16.), 97.1 (19.)  
 Trefferlage: 0.21 mm rechts, 0.16 mm tief  
 Streuwert: 1.00, horizontal: 0.80, vertikal: 1.17

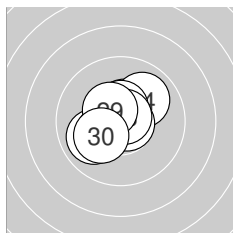

**Serie 3: 104.0 (99)**

10.5* ↑	9.9 ↙	10.3* ↖	10.0 ↗	10.7* →
10.6* ↖	10.5* ↑	10.8* ↗	10.5* ↖	10.2* ↖

beste Teiler: 46.2 (28.), 55.0 (25.), 85.5 (26.)  
 Trefferlage: 0.34 mm links, 0.25 mm hoch  
 Streuwert: 1.11, horizontal: 1.16, vertikal: 1.05

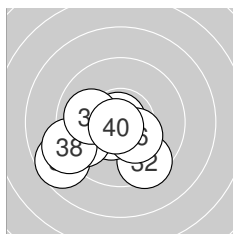

**Serie 4: 100.0 (95)**

10.7* ↖	9.5 ↘	8.7 ↙	10.5* ↖	10.8* ↖
10.3* ↘	9.6 ↙	9.1 ↙	10.0 ←	10.8* ↖

beste Teiler: 27.6 (35.), 50.9 (40.), 72.2 (31.)  
 Trefferlage: 1.29 mm links, 1.18 mm tief  
 Streuwert: 1.79, horizontal: 2.21, vertikal: 1.25



Ergebnis: **422.8** (400)  
 Serien: 106.4 104.2 107.2 105.0  
 Zähler: 40 0 0 0 0 0 0 0 0 0  
 Innenzehner: 38  
 Weitester: 229 (3.), 212 (11.), 182 (15.)  
 beste Teiler: 13.0 (6.), 13.0 (23.), 23.8 (28.)  
 Trefferlage: 0.00 mm , 0.12 mm tief  
 Streuwert: 0.79, horizontal: 0.95, vertikal: 0.59

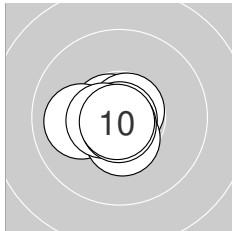
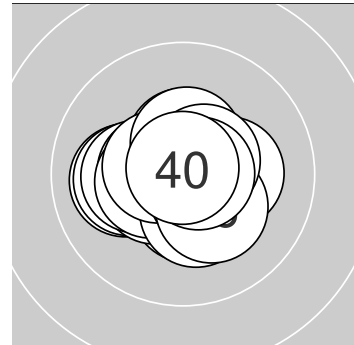

**Serie 1: 106.4 (100)**

10.8* ←	10.7* ↘	10.0 ←	10.7* ↗	10.7* ↓
10.9* ↓	10.4* ↓	10.6* ←	10.8* ↓	10.8* ↗

beste Teiler: 13.0 (6.), 32.2 (10.), 38.9 (1.)  
 Trefferlage: 0.40 mm links, 0.25 mm tief  
 Streuwert: 0.63, horizontal: 0.77, vertikal: 0.46

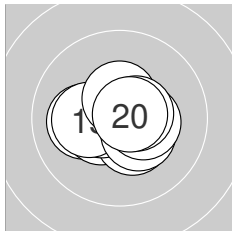

**Serie 2: 104.2 (100)**

10.1 ←	10.5* ←	10.4* ↘	10.5* ←	10.2* ←
10.4* ↘	10.5* ↑	10.4* →	10.5* →	10.7* →

beste Teiler: 66.1 (20.), 101.9 (19.), 106.6 (14.)  
 Trefferlage: 0.11 mm links, 0.15 mm tief  
 Streuwert: 1.03, horizontal: 1.30, vertikal: 0.65

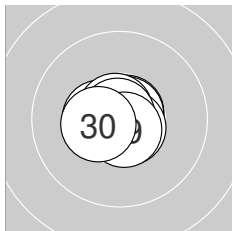

**Serie 3: 107.2 (100)**

10.7* ↗	10.5* ←	10.9* ↘	10.9* ↗	10.8* ↗
10.7* ↘	10.7* ↘	10.9* ↘	10.7* ↓	10.4* ←

beste Teiler: 13.0 (23.), 23.8 (28.), 24.6 (24.)  
 Trefferlage: 0.10 mm links, 0.01 mm hoch  
 Streuwert: 0.52, horizontal: 0.64, vertikal: 0.38

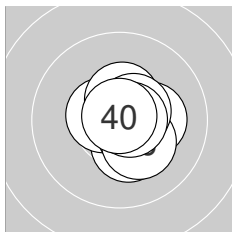

**Serie 4: 105.0 (100)**

10.5* →	10.3* ↓	10.5* ←	10.5* ↘	10.2* →
10.3* ↘	10.5* ↑	10.6* ↗	10.7* →	10.9* ↑

beste Teiler: 25.0 (40.), 61.0 (39.), 99.0 (38.)  
 Trefferlage: 0.61 mm rechts, 0.11 mm tief  
 Streuwert: 0.80, horizontal: 0.76, vertikal: 0.83



# LG 40 AUT Senioren

StandNr: 27

Entner, Amita #227

# Frauen

Wertung

StartNr: 231

21.03.2024 13:48

T – SG Wörgl / Tirol 1

Ergebnis: **417.7** (400)  
 Serien: 104.9 103.8 104.1 104.9  
 Zähler: 40 0 0 0 0 0 0 0 0 0  
 Innenzehner: 35  
 Weitestе: 241 (18.), 226 (15.), 216 (23.)  
 beste Teiler: 23.0 (40.), 32.7 (8.), 39.2 (24.)  
 Trefferlage: 0.45 mm rechts, 0.47 mm tief  
 Streuwert: 0.88, horizontal: 0.92, vertikal: 0.84

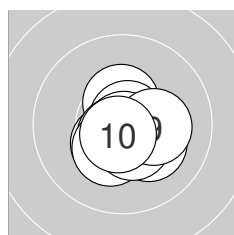
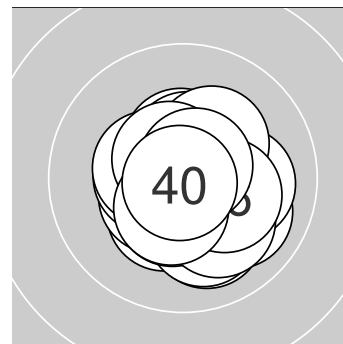

### Serie 1: 104.9 (100)

10.4* ↑	10.8* ↗	10.2* ↘	10.4* ↙	10.6* ↘
10.3* ↙	10.5* ↘	10.8* ↓	10.2* →	10.7* ↙

beste Teiler: 32.7 (8.), 42.4 (2.), 65.7 (10.)  
 Trefferlage: 0.19 mm rechts, 0.48 mm tief  
 Streuwert: 0.85, horizontal: 0.89, vertikal: 0.80

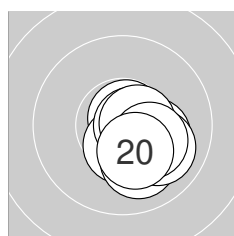

### Serie 2: 103.8 (100)

10.5* →	10.2* →	10.8* ↗	10.5* ↓	10.0 ↓
10.7* →	10.6* →	10.0 ↘	10.2* →	10.3* ↘

beste Teiler: 45.6 (13.), 54.0 (16.), 87.6 (17.)  
 Trefferlage: 0.96 mm rechts, 0.73 mm tief  
 Streuwert: 0.73, horizontal: 0.67, vertikal: 0.79

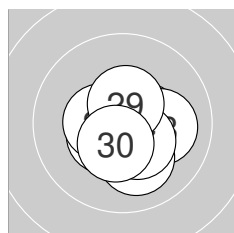

### Serie 3: 104.1 (100)

10.5* ↘	10.5* →	10.1 →	10.8* ↙	10.4* ↘
10.1 ↓	10.4* ↘	10.4* ←	10.5* ↑	10.4* ↙

beste Teiler: 39.2 (24.), 102.0 (21.), 114.4 (29.)  
 Trefferlage: 0.32 mm rechts, 0.47 mm tief  
 Streuwert: 0.96, horizontal: 1.06, vertikal: 0.85

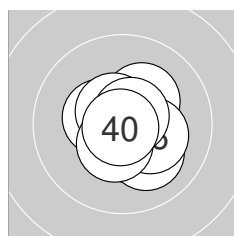

### Serie 4: 104.9 (100)

10.4* ←	10.5* ↓	10.1 ↘	10.6* →	10.3* ↗
10.3* →	10.6* ↘	10.7* ↗	10.5* ↙	10.9* ↘

beste Teiler: 23.0 (40.), 68.5 (38.), 83.4 (34.)  
 Trefferlage: 0.33 mm rechts, 0.21 mm tief  
 Streuwert: 0.95, horizontal: 0.93, vertikal: 0.96



# LG 40 AUT Senioren

# Frauen

# StartNr: 232

StandNr: 28

Wertung

21.03.2024 13:52

Streimelweger, Christina #228

NÖ – SV St. Anton/J / Niederösterreich 1

Ergebnis: **412.5** (393)  
 Serien: 103.7 103.6 103.8 101.4  
 Zähler: 33 7 0 0 0 0 0 0 0 0  
 Innenzehner: 29  
 Weitestе: 410 (16.), 405 (38.), 329 (6.)  
 beste Teiler: 39.8 (7.), 47.5 (12.), 48.8 (24.)  
 Trefferlage: 0.30 mm rechts, 0.06 mm hoch  
 Streuwert: 1.32, horizontal: 1.46, vertikal: 1.16

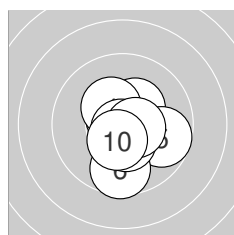
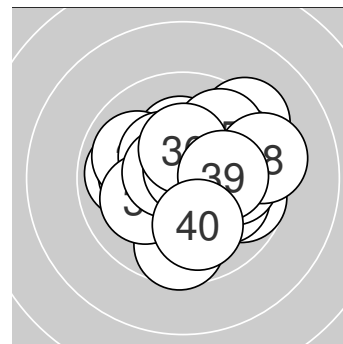
**Serie 1: 103.7 (98)**

10.8* ↗	10.3* ↗	10.7* ↘	10.3* ↘	9.7 →
9.6 ↓	10.8* ↓	10.4* ↓	10.6* →	10.5* ↓

beste Teiler: 39.8 (7.), 50.6 (1.), 68.6 (3.)  
 Trefferlage: 0.32 mm rechts, 0.39 mm tief  
 Streuwert: 1.23, horizontal: 1.08, vertikal: 1.36

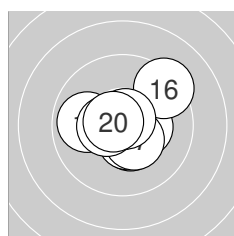
**Serie 2: 103.6 (98)**

9.9 ←	10.8* ↘	10.4* ↓	10.5* ↓	10.4* →
9.3 ↗	10.4* ↘	10.5* ←	10.7* ↗	10.7* ↖

beste Teiler: 47.5 (12.), 51.4 (19.), 73.7 (20.)  
 Trefferlage: 0.25 mm rechts, 0.00 mm  
 Streuwert: 1.35, horizontal: 1.53, vertikal: 1.13

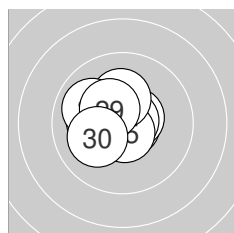
**Serie 3: 103.8 (99)**

10.2* ←	10.7* ↘	10.6* ↗	10.8* →	10.7* ↓
10.2* ↑	10.2* ←	9.9 ↖	10.4* ↘	10.1 ↖

beste Teiler: 48.8 (24.), 57.0 (22.), 69.6 (25.)  
 Trefferlage: 0.70 mm links, 0.32 mm hoch  
 Streuwert: 1.04, horizontal: 1.20, vertikal: 0.85

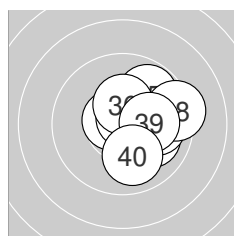
**Serie 4: 101.4 (98)**

10.0 ↘	10.6* ↖	10.4* ↗	10.7* ↗	9.8 ↗
10.4* ↑	10.0 →	9.3 →	10.2* →	10.0 ↓

beste Teiler: 51.6 (34.), 82.2 (32.), 127.5 (33.)  
 Trefferlage: 1.33 mm rechts, 0.31 mm hoch  
 Streuwert: 1.33, horizontal: 1.39, vertikal: 1.28



Ergebnis: **416.2** (398)  
 Serien: 103.8 104.1 103.6 104.7  
 Zähler: 38 2 0 0 0 0 0 0 0 0  
 Innenzehner: 33  
 Weitestе: 270 (7.), 258 (26.), 238 (19.)  
 beste Teiler: 6.4 (31.), 37.6 (3.), 44.9 (15.)  
 Trefferlage: 0.30 mm links, 0.13 mm hoch  
 Streuwert: 1.06, horizontal: 1.09, vertikal: 1.04

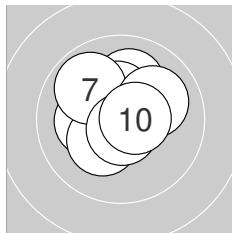
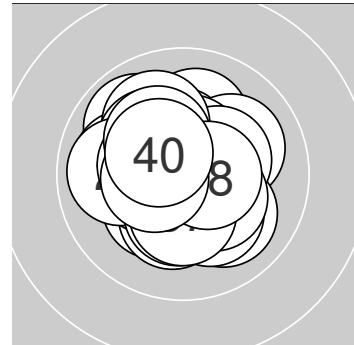

**Serie 1: 103.8 (99)**

10.2* ←	10.8* →	10.8* ↘	10.1 ↑	10.4* ↑
10.3* ↗	9.9 ↘	10.7* ↓	10.0 ↗	10.6* →

beste Teiler: 37.6 (3.), 45.1 (2.), 63.7 (8.)  
 Trefferlage: 0.13 mm links, 0.49 mm hoch  
 Streuwert: 1.17, horizontal: 1.23, vertikal: 1.11

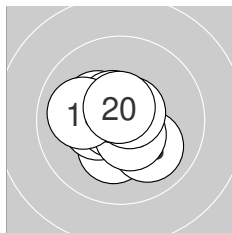

**Serie 2: 104.1 (100)**

10.2* ↓	10.3* ↘	10.0 ↘	10.4* ←	10.8* ←
10.5* ↘	10.7* ↗	10.6* ↘	10.0 ←	10.6* ↑

beste Teiler: 44.9 (15.), 73.1 (17.), 80.5 (20.)  
 Trefferlage: 0.38 mm links, 0.11 mm tief  
 Streuwert: 1.08, horizontal: 1.16, vertikal: 0.99

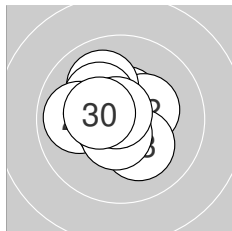

**Serie 3: 103.6 (99)**

10.5* ↑	10.3* →	10.2* ↘	10.0 ↘	10.2* ↘
9.9 ←	10.7* ↗	10.6* ↓	10.8* ↘	10.4* ←

beste Teiler: 48.2 (29.), 69.5 (27.), 96.1 (28.)  
 Trefferlage: 0.45 mm links, 0.29 mm hoch  
 Streuwert: 1.15, horizontal: 1.21, vertikal: 1.08

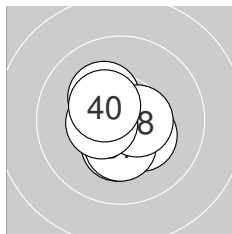

**Serie 4: 104.7 (100)**

10.9* ↗	10.3* ↘	10.2* ↘	10.6* ↘	10.3* ↓
10.7* ←	10.3* ↓	10.5* →	10.5* ←	10.4* ↘

beste Teiler: 6.4 (31.), 52.2 (36.), 82.2 (34.)  
 Trefferlage: 0.23 mm links, 0.14 mm tief  
 Streuwert: 0.91, horizontal: 0.84, vertikal: 0.98





**Ergebnis: 407.7 (386)**  
**Serien:** 103.5 101.1 99.2 103.9  
**Zähler:** 26 14 0 0 0 0 0 0 0 0  
**Innenzehner:** 22  
**Weiteste:** 475 (26.), 438 (21.), 429 (14.)  
**beste Teiler:** 13.0 (6.), 17.0 (11.), 17.8 (18.)  
**Trefferlage:** 0.24 mm links, 0.99 mm tief  
**Streuwert:** 1.47, horizontal: 1.53, vertikal: 1.42

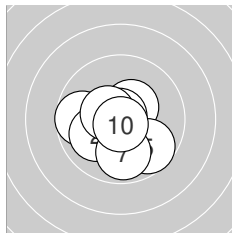
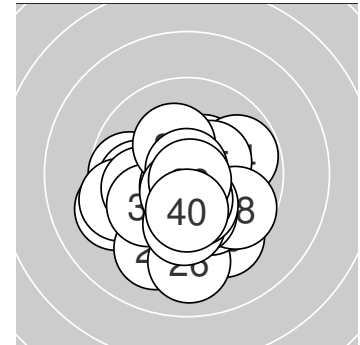

**Serie 1: 103.5 (97)**

9.7 ←	10.0 ↙	10.4* ↗	10.8* ↖	9.7 ↘
10.9* ←	9.9 ↓	10.8* ↖	10.5* ↖	10.8* ↓

**beste Teiler:** 13.0 (6.), 29.7 (8.), 34.6 (4.)  
**Trefferlage:** 0.33 mm links, 0.44 mm tief  
**Streuwert:** 1.34, horizontal: 1.46, vertikal: 1.20

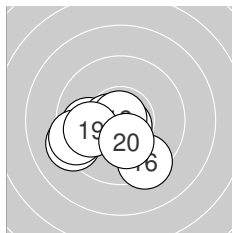

**Serie 2: 101.1 (95)**

10.9* ↓	9.9 ←	10.7* ↘	9.2 ↖	10.6* ←
9.4 ↘	9.4 ↖	10.9* ↖	9.9 ↖	10.2* ↓

**beste Teiler:** 17.0 (11.), 17.8 (18.), 57.9 (13.)  
**Trefferlage:** 1.08 mm links, 1.01 mm tief  
**Streuwert:** 1.57, horizontal: 1.95, vertikal: 1.08

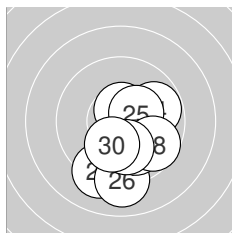

**Serie 3: 99.2 (96)**

9.2 ↙	10.2* ↘	10.6* ↑	9.8 →	10.4* ↗
9.1 ↓	10.0 ↘	9.7 ↘	10.1 ↓	10.1 ↓

**beste Teiler:** 92.2 (23.), 143.5 (25.), 179.8 (22.)  
**Trefferlage:** 0.69 mm rechts, 1.58 mm tief  
**Streuwert:** 1.69, horizontal: 1.37, vertikal: 1.96

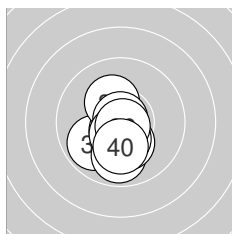

**Serie 4: 103.9 (98)**

9.9 ↙	10.7* ↙	10.3* ↖	9.9 ↓	10.9* ↑
10.5* ↙	10.3* ↘	10.4* ↓	10.8* ↘	10.2* ↓

**beste Teiler:** 23.0 (35.), 37.5 (39.), 74.6 (32.)  
**Trefferlage:** 0.27 mm links, 0.95 mm tief  
**Streuwert:** 1.02, horizontal: 0.73, vertikal: 1.24



**Ergebnis: 422.2 (399)**  
**Serien: 105.1 106.0 104.7 106.4**  
**Zähler: 39 1 0 0 0 0 0 0 0 0**  
**Innenzehner: 35**  
**Weiteste: 299 (22.), 248 (11.), 233 (20.)**  
**beste Teiler: 4.1 (26.), 9.8 (14.), 15.1 (13.)**  
**Trefferlage: 0.30 mm links, 0.05 mm hoch**  
**Streuwert: 0.83, horizontal: 0.80, vertikal: 0.87**

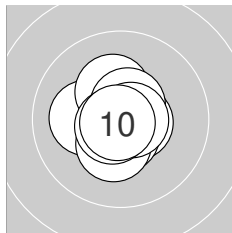
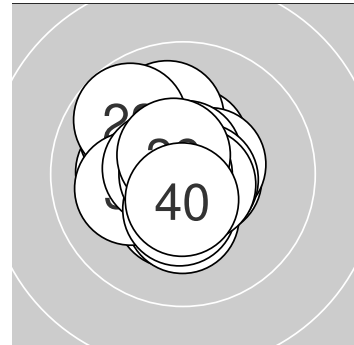

**Serie 1: 105.1 (100)**

10.4* ←	10.1 ←	10.3* ↑	10.6* →	10.6* ↓
10.3* ↓	10.6* ↑	10.7* →	10.7* ↙	10.8* ↘

**beste Teiler: 28.3 (10.), 61.2 (8.), 64.5 (9.)**  
**Trefferlage: 0.29 mm links, 0.07 mm tief**  
**Streuwert: 0.87, horizontal: 0.88, vertikal: 0.85**

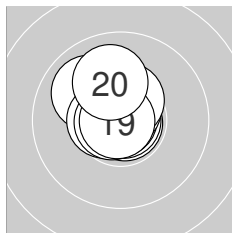

**Serie 2: 106.0 (100)**

10.0 ↘	10.8* ↘	10.9* →	10.9* ↘	10.6* ←
10.7* ↑	10.5* ↑	10.7* ←	10.9* ←	10.0 ↑

**beste Teiler: 9.8 (14.), 15.1 (13.), 21.3 (19.)**  
**Trefferlage: 0.33 mm links, 0.54 mm hoch**  
**Streuwert: 0.78, horizontal: 0.69, vertikal: 0.86**

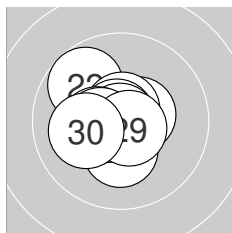

**Serie 3: 104.7 (99)**

10.5* →	9.8 ↘	10.7* ↑	10.8* ↘	10.3* ↓
10.9* ←	10.4* ←	10.5* ←	10.7* ↘	10.1 ←

**beste Teiler: 4.1 (26.), 34.7 (24.), 65.2 (29.)**  
**Trefferlage: 0.53 mm links, 0.03 mm hoch**  
**Streuwert: 1.03, horizontal: 1.08, vertikal: 0.99**

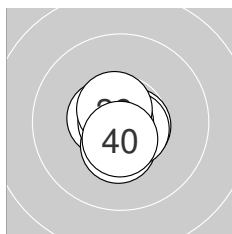

**Serie 4: 106.4 (100)**

10.6* ←	10.6* ↓	10.6* →	10.4* ↓	10.8* ←
10.9* ↙	10.6* ↘	10.8* ←	10.6* ↘	10.5* ↓

**beste Teiler: 21.0 (36.), 26.0 (35.), 29.0 (38.)**  
**Trefferlage: 0.07 mm links, 0.29 mm tief**  
**Streuwert: 0.57, horizontal: 0.49, vertikal: 0.63**



**Ergebnis: 419.8 (398)**  
**Serien: 104.3 105.2 105.1 105.2**  
**Zähler: 38 2 0 0 0 0 0 0 0 0**  
**Innenzehner: 33**  
**Weiteste: 303 (35.), 285 (2.), 226 (17.)**  
**beste Teiler: 13.0 (3.), 16.1 (7.), 20.0 (15.)**  
**Trefferlage: 0.03 mm links, 0.09 mm tief**  
**Streuwert: 0.96, horizontal: 0.95, vertikal: 0.97**

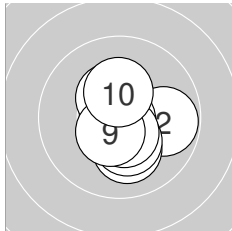
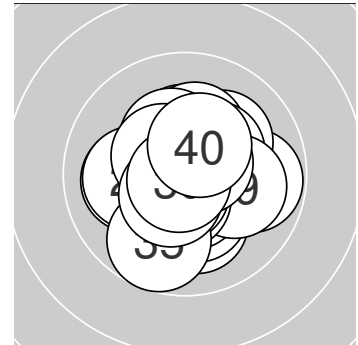

**Serie 1: 104.3 (99)**

10.4* ↖	9.8 →	10.9* ↓	10.6* ↓	10.1 ↓
10.3* ↓	10.9* ↘	10.5* ↓	10.5* ↗	10.3* ↑

**beste Teiler: 13.0 (3.), 16.1 (7.), 85.1 (4.)**  
**Trefferlage: 0.28 mm rechts, 0.40 mm tief**  
**Streuwert: 1.07, horizontal: 0.98, vertikal: 1.15**

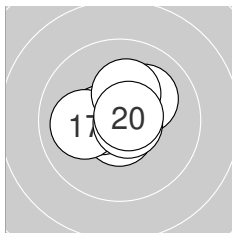

**Serie 2: 105.2 (100)**

10.7* ↓	10.5* ←	10.7* →	10.7* ↑	10.9* ↑
10.1 ↗	10.0 ←	10.2* ↑	10.7* ↘	10.7* ↗

**beste Teiler: 20.0 (15.), 55.7 (13.), 57.0 (19.)**  
**Trefferlage: 0.02 mm rechts, 0.30 mm hoch**  
**Streuwert: 0.91, horizontal: 1.05, vertikal: 0.75**

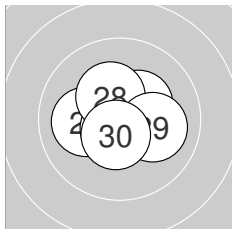

**Serie 3: 105.1 (100)**

10.3* ↗	10.8* ↖	10.7* ↓	10.8* ↙	10.1 ←
10.8* ↓	10.7* ↘	10.3* ↖	10.1 →	10.5* ↓

**beste Teiler: 37.0 (26.), 38.0 (24.), 48.8 (22.)**  
**Trefferlage: 0.07 mm links, 0.08 mm tief**  
**Streuwert: 0.96, horizontal: 1.13, vertikal: 0.75**

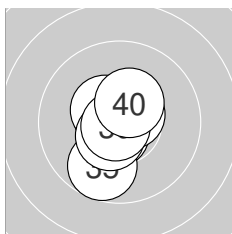

**Serie 4: 105.2 (99)**

10.6* ↓	10.7* ↗	10.8* ↖	10.6* ↖	9.7 ↓
10.6* ↗	10.5* ↖	10.5* ↘	10.8* ↗	10.4* ↑

**beste Teiler: 36.7 (39.), 50.4 (33.), 71.0 (32.)**  
**Trefferlage: 0.36 mm links, 0.20 mm tief**  
**Streuwert: 0.91, horizontal: 0.60, vertikal: 1.14**



Ergebnis: **410.0** (395)  
 Serien: 103.9 102.7 101.7 101.7  
 Zähler: 35 5 0 0 0 0 0 0 0 0  
 Innenzehner: 26  
 Weitester: 366 (39.), 324 (40.), 294 (30.)  
 beste Teiler: 38.9 (10.), 70.4 (32.), 76.2 (9.)  
 Trefferlage: 0.67 mm rechts, 0.17 mm hoch  
 Streuwert: 1.27, horizontal: 1.28, vertikal: 1.25

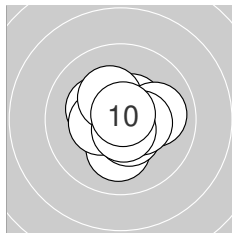
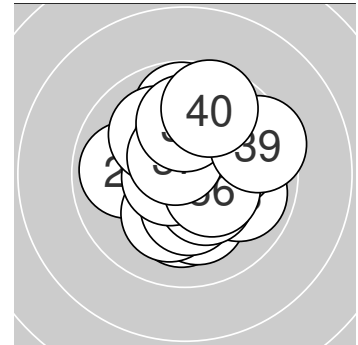

**Serie 1: 103.9 (100)**

10.1 ↓	10.5* ↘	10.3* ↖	10.5* ↗	10.4* ←
10.3* ↖	10.0 →	10.4* →	10.6* ↓	10.8* ↗

beste Teiler: 38.9 (10.), 76.2 (9.), 117.2 (4.)  
 Trefferlage: 0.15 mm rechts, 0.05 mm tief  
 Streuwert: 1.13, horizontal: 1.21, vertikal: 1.04

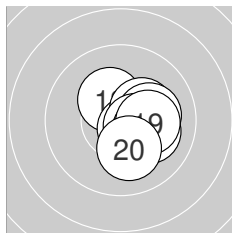

**Serie 2: 102.7 (100)**

10.3* ↘	10.3* ↖	10.6* ↘	10.3* ↗	10.1 →
10.5* →	10.2* ↘	10.1 →	10.2* →	10.1 ↓

beste Teiler: 84.8 (13.), 111.0 (16.), 160.1 (12.)  
 Trefferlage: 1.16 mm rechts, 0.32 mm tief  
 Streuwert: 0.91, horizontal: 0.84, vertikal: 0.96

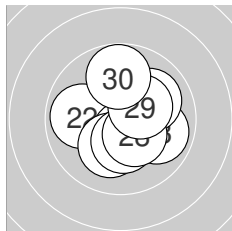

**Serie 3: 101.7 (97)**

10.3* →	9.9 ←	9.9 →	10.6* ↓	10.0 ↗
10.2* ↓	10.3* ↓	10.4* ↘	10.3* ↗	9.8 ↑

beste Teiler: 99.4 (24.), 142.9 (28.), 153.0 (27.)  
 Trefferlage: 0.54 mm rechts, 0.04 mm tief  
 Streuwert: 1.50, horizontal: 1.52, vertikal: 1.48

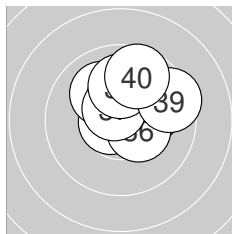

**Serie 4: 101.7 (98)**

10.3* →	10.7* ←	10.1 ↖	10.1 →	10.3* ↗
10.4* ↘	10.6* ↖	10.0 ↑	9.5 →	9.7 ↑

beste Teiler: 70.4 (32.), 92.1 (37.), 141.3 (36.)  
 Trefferlage: 0.81 mm rechts, 1.10 mm hoch  
 Streuwert: 1.28, horizontal: 1.42, vertikal: 1.12



# LG 40 AUT Senioren

StandNr: 34

Greiderer, Christiane #234

# Frauen

Wertung

StartNr: 238

21.03.2024 13:51

T – SG Bruckhäusl

Ergebnis: **416.2** (394)  
 Serien: 104.3 103.0 105.4 103.5  
 Zähler: 34 6 0 0 0 0 0 0 0 0  
 Innenzehner: 30  
 Weitestе: 349 (2.), 301 (12.), 289 (40.)  
 beste Teiler: 6.0 (37.), 26.0 (11.), 31.3 (26.)  
 Trefferlage: 0.05 mm links, 0.26 mm hoch  
 Streuwert: 1.16, horizontal: 1.24, vertikal: 1.06

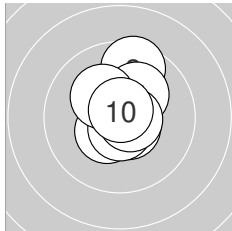
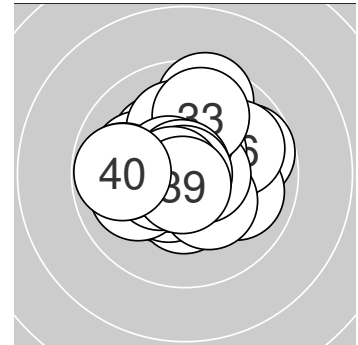

### Serie 1: 104.3 (99)

10.4* ↑	9.6 ↑	10.8* ↓	10.4* ↙	10.6* ↘
10.6* ↓	10.2* ↗	10.2* ↘	10.7* →	10.8* ↑

beste Teiler: 44.0 (3.), 50.6 (10.), 75.5 (9.)  
 Trefferlage: 0.19 mm rechts, 0.53 mm hoch  
 Streuwert: 1.12, horizontal: 0.75, vertikal: 1.40

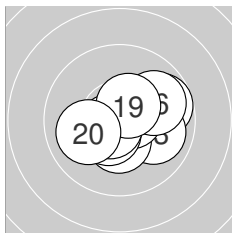

### Serie 2: 103.0 (98)

10.8* →	9.7 →	10.0 →	10.4* ↓	10.6* →
9.9 →	10.5* ↙	10.6* ↙	10.5* ↗	10.0 ↙

beste Teiler: 26.0 (11.), 77.9 (18.), 81.2 (15.)  
 Trefferlage: 0.55 mm rechts, 0.09 mm tief  
 Streuwert: 1.30, horizontal: 1.59, vertikal: 0.93

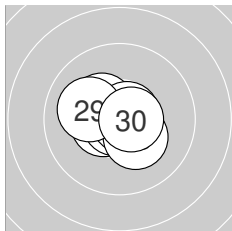

### Serie 3: 105.4 (100)

10.7* ↘	10.6* ↙	10.3* ↘	10.5* ↙	10.8* ↙
10.8* →	10.7* ↗	10.3* ↘	10.1 ↙	10.6* →

beste Teiler: 31.3 (26.), 43.2 (25.), 62.4 (27.)  
 Trefferlage: 0.24 mm links, 0.08 mm tief  
 Streuwert: 0.87, horizontal: 1.06, vertikal: 0.62

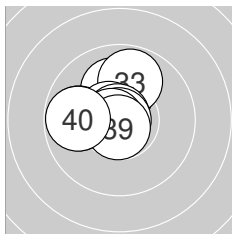

### Serie 4: 103.5 (97)

10.3* ↑	10.1 ↑	9.8 ↑	9.8 ←	10.6* ↘
10.8* ↘	10.9* ←	10.7* ←	10.7* ↓	9.8 ←

beste Teiler: 6.0 (37.), 31.3 (36.), 51.4 (39.)  
 Trefferlage: 0.70 mm links, 0.68 mm hoch  
 Streuwert: 1.14, horizontal: 1.20, vertikal: 1.07



**Ergebnis: 421.0 (399)**  
**Serien: 104.9 106.7 104.3 105.1**  
**Zähler: 39 1 0 0 0 0 0 0 0 0**  
**Innenzehner: 37**  
**Weiteste: 251 (3.), 244 (27.), 217 (38.)**  
**beste Teiler: 11.7 (15.), 21.5 (16.), 26.0 (8.)**  
**Trefferlage: 0.25 mm links, 0.27 mm hoch**  
**Streuwert: 0.84, horizontal: 0.84, vertikal: 0.85**

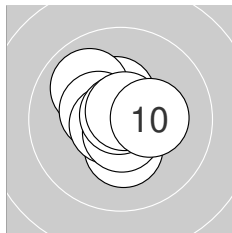
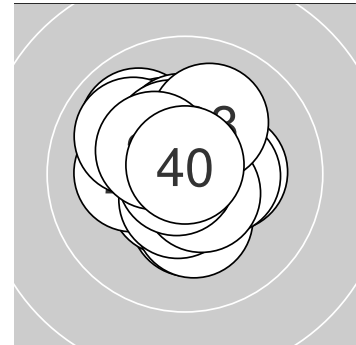

**Serie 1: 104.9 (99)**

10.8* ↘	10.4* ↑	9.9 ↘	10.3* ↓	10.4* ↖
10.7* ↙	10.6* ↓	10.8* ↗	10.7* ↑	10.3* →

**beste Teiler: 26.0 (8.), 49.2 (1.), 51.4 (9.)**  
**Trefferlage: 0.23 mm links, 0.19 mm hoch**  
**Streuwert: 0.95, horizontal: 0.93, vertikal: 0.98**

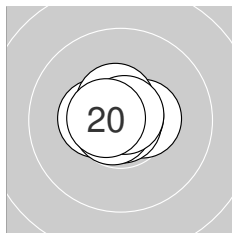

**Serie 2: 106.7 (100)**

10.5* →	10.4* ←	10.6* ↑	10.8* ↗	10.9* ↖
10.9* ↓	10.7* ↙	10.5* ↑	10.8* ↗	10.6* ←

**beste Teiler: 11.7 (15.), 21.5 (16.), 29.6 (14.)**  
**Trefferlage: 0.15 mm links, 0.22 mm hoch**  
**Streuwert: 0.57, horizontal: 0.69, vertikal: 0.42**

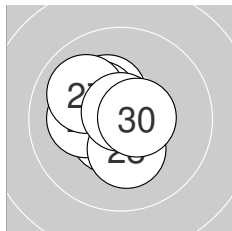

**Serie 3: 104.3 (100)**

10.6* ←	10.3* ↖	10.5* ↗	10.7* ↙	10.3* ↖
10.2* ←	10.0 ↘	10.3* ↓	10.8* ↑	10.6* →

**beste Teiler: 41.0 (29.), 61.2 (24.), 89.2 (21.)**  
**Trefferlage: 0.67 mm links, 0.18 mm hoch**  
**Streuwert: 0.96, horizontal: 0.93, vertikal: 0.99**

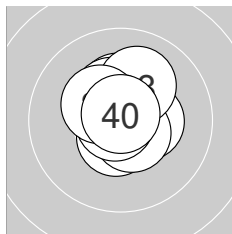

**Serie 4: 105.1 (100)**

10.6* ↓	10.3* ↑	10.4* →	10.7* ↖	10.4* ↖
10.6* ↘	10.8* ←	10.1 ↗	10.4* ↖	10.8* ↑

**beste Teiler: 33.2 (37.), 35.0 (40.), 58.6 (34.)**  
**Trefferlage: 0.03 mm rechts, 0.48 mm hoch**  
**Streuwert: 0.87, horizontal: 0.75, vertikal: 0.97**



# LG 40 AUT Senioren

StandNr: 36

Bachleitner, Nadine #236

# Frauen

Wertung

StartNr: 240

21.03.2024 13:46

OÖ – SV Frankenburg

Ergebnis: **407.8** (391)  
 Serien: 99.1 103.2 102.1 103.4  
 Zähler: 32 7 1 0 0 0 0 0 0 0  
 Innenzehner: 23  
 Weitester: 609 (6.), 394 (10.), 304 (22.)  
 beste Teiler: 26.0 (16.), 36.4 (31.), 43.5 (33.)  
 Trefferlage: 0.34 mm links, 0.03 mm tief  
 Streuwert: 1.53, horizontal: 1.75, vertikal: 1.27

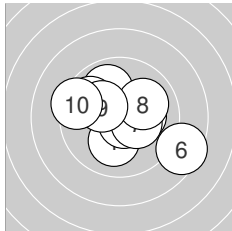
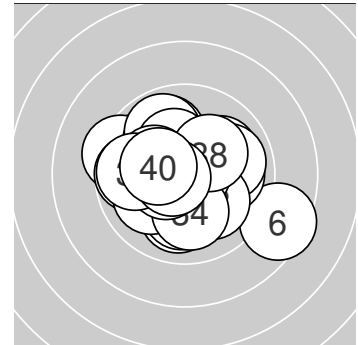

### Serie 1: 99.1 (95)

10.1 ↓	10.7* ↘	9.9 ↘	9.8 ↖	10.2* →
8.5 ↘	10.3* ↘	10.0 →	10.2* ↖	9.4 ↖

beste Teiler: 60.6 (2.), 154.9 (7.), 180.9 (9.)  
 Trefferlage: 0.17 mm rechts, 0.13 mm hoch  
 Streuwert: 2.19, horizontal: 2.65, vertikal: 1.61

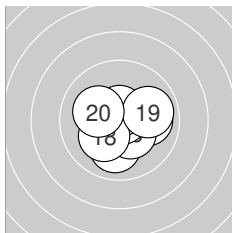

### Serie 2: 103.2 (99)

10.6* ↖	10.0 →	10.0 ↓	10.5* ←	10.4* ↘
10.8* ↗	10.6* ↑	10.2* ↙	9.9 →	10.2* ↖

beste Teiler: 26.0 (16.), 80.0 (17.), 89.5 (11.)  
 Trefferlage: 0.05 mm rechts, 0.19 mm tief  
 Streuwert: 1.30, horizontal: 1.49, vertikal: 1.07

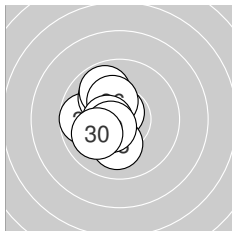

### Serie 3: 102.1 (98)

10.5* ↙	9.7 ←	10.7* ↑	10.0 ↘	9.8 ↘
10.3* ↘	10.5* ←	10.1 ↓	10.5* ↙	10.0 ↙

beste Teiler: 59.5 (23.), 102.0 (29.), 107.0 (27.)  
 Trefferlage: 1.14 mm links, 0.15 mm hoch  
 Streuwert: 1.20, horizontal: 0.87, vertikal: 1.46

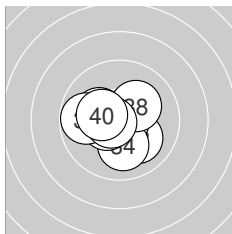

### Serie 4: 103.4 (99)

10.8* ↓	10.1 ↘	10.8* →	10.1 ↓	10.2* ↖
10.5* ↙	9.8 ←	10.2* ↗	10.6* ←	10.3* ↖

beste Teiler: 36.4 (31.), 43.5 (33.), 76.6 (39.)  
 Trefferlage: 0.45 mm links, 0.22 mm tief  
 Streuwert: 1.24, horizontal: 1.44, vertikal: 1.01



# LG 40 AUT Senioren

StandNr: 37

Kavelar, Christine #237

# Frauen

Wertung

StartNr: 241

21.03.2024 13:46

T – SG Bruckhäusl

Ergebnis: **411.1** (395)  
 Serien: 101.6 103.9 102.3 103.3  
 Zähler: 35 5 0 0 0 0 0 0 0 0  
 Innenzehner: 26  
 Weitestе: 413 (24.), 341 (4.), 265 (30.)  
 beste Teiler: 27.2 (22.), 27.7 (9.), 39.9 (21.)  
 Trefferlage: 0.05 mm links, 0.65 mm hoch  
 Streuwert: 1.27, horizontal: 1.38, vertikal: 1.14

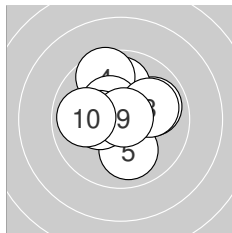
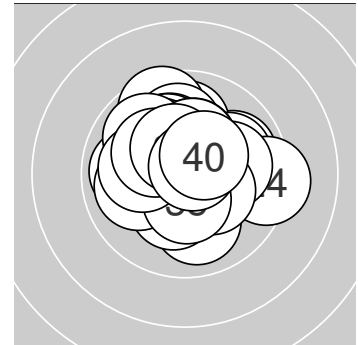

### Serie 1: 101.6 (97)

9.9 →	10.0 ↑	10.7* ↙	9.6 ↖	10.0 ↓
10.4* ↘	10.3* ←	10.0 →	10.8* ↗	9.9 ←

beste Teiler: 27.7 (9.), 53.5 (3.), 133.4 (6.)  
 Trefferlage: 0.11 mm links, 0.62 mm hoch  
 Streuwert: 1.55, horizontal: 1.58, vertikal: 1.53

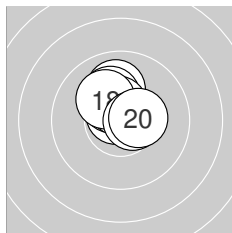

### Serie 2: 103.9 (100)

10.7* ↑	10.7* ↘	10.2* ↑	10.0 ↑	10.4* ↖
10.2* ↘	10.5* ↑	10.2* ↘	10.6* →	10.4* →

beste Teiler: 56.6 (12.), 61.0 (11.), 91.0 (19.)  
 Trefferlage: 0.17 mm links, 1.12 mm hoch  
 Streuwert: 0.78, horizontal: 0.76, vertikal: 0.81

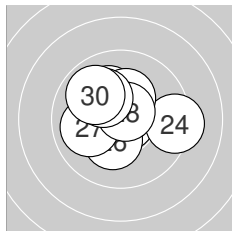

### Serie 3: 102.3 (98)

10.8* ↘	10.8* ↑	10.1 ↘	9.3 →	10.3* ↑
10.3* ↓	10.0 ←	10.7* ↗	10.1 ↘	9.9 ↖

beste Teiler: 27.2 (22.), 39.9 (21.), 67.9 (28.)  
 Trefferlage: 0.17 mm links, 0.50 mm hoch  
 Streuwert: 1.53, horizontal: 1.80, vertikal: 1.19

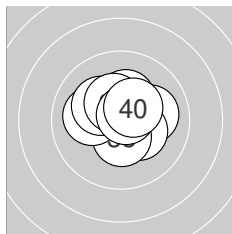

### Serie 4: 103.3 (100)

10.4* →	10.1 →	10.3* ↑	10.3* ↘	10.4* ↓
10.1 ←	10.2* ↘	10.4* ↘	10.7* ↗	10.4* ↗

beste Teiler: 55.8 (39.), 128.3 (35.), 135.0 (40.)  
 Trefferlage: 0.26 mm rechts, 0.36 mm hoch  
 Streuwert: 1.16, horizontal: 1.35, vertikal: 0.93





**Ergebnis: 413.1 (394)**  
**Serien: 103.3 102.8 103.9 103.1**  
**Zähler: 34 6 0 0 0 0 0 0 0 0 0**  
**Innenzehner: 28**  
**Weiteste: 385 (16.), 378 (21.), 319 (32.)**  
**beste Teiler: 13.6 (9.), 29.8 (37.), 49.8 (12.)**  
**Trefferlage: 0.44 mm links, 0.31 mm tief**  
**Streuwert: 1.25, horizontal: 1.54, vertikal: 0.86**

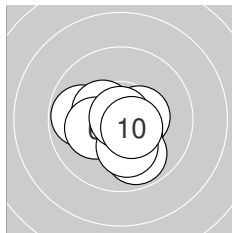
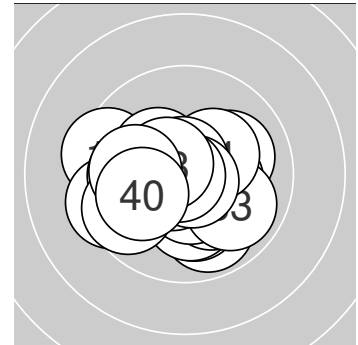

**Serie 1: 103.3 (98)**

10.5* ←	9.8 ←	10.4* →	10.4* ↖	10.5* ↘
10.2* ←	9.9 ↘	10.1 ↘	10.9* ↑	10.6* ↘

**beste Teiler: 13.6 (9.), 100.0 (10.), 120.6 (5.)**  
**Trefferlage: 0.27 mm links, 0.55 mm tief**  
**Streuwert: 1.23, horizontal: 1.42, vertikal: 1.00**

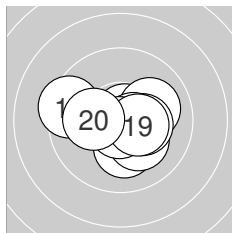

**Serie 2: 102.8 (99)**

10.2* ↓	10.8* ↗	10.2* ↘	10.0 →	10.3* →
9.4 ←	10.6* →	10.7* ↓	10.4* →	10.2* ←

**beste Teiler: 49.8 (12.), 54.7 (18.), 95.0 (17.)**  
**Trefferlage: 0.19 mm rechts, 0.25 mm tief**  
**Streuwert: 1.41, horizontal: 1.78, vertikal: 0.91**

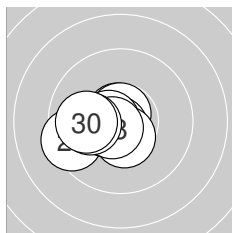

**Serie 3: 103.9 (99)**

9.4 ←	10.5* ←	10.7* ↖	10.7* ↑	10.8* ↗
10.6* ←	10.5* ↓	10.6* ↗	10.1 ←	10.0 ←

**beste Teiler: 50.7 (25.), 53.1 (24.), 56.8 (23.)**  
**Trefferlage: 1.09 mm links, 0.29 mm tief**  
**Streuwert: 0.98, horizontal: 1.24, vertikal: 0.61**

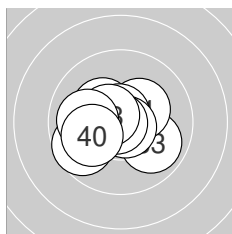

**Serie 4: 103.1 (98)**

10.3* ↖	9.7 ↗	9.9 ↘	10.3* ↗	10.7* ↑
10.8* ↘	10.8* ←	10.6* ↖	10.0 ←	10.0 ↗

**beste Teiler: 29.8 (37.), 50.2 (36.), 54.3 (35.)**  
**Trefferlage: 0.58 mm links, 0.13 mm tief**  
**Streuwert: 1.32, horizontal: 1.61, vertikal: 0.94**



Ergebnis: **413.6** (393)  
 Serien: 102.7 105.4 103.1 102.4  
 Zähler: 33 7 0 0 0 0 0 0 0 0  
 Innenzehner: 30  
 Weitestе: 322 (8.), 317 (9.), 308 (34.)  
 beste Teiler: 11.1 (14.), 16.1 (6.), 36.1 (31.)  
 Trefferlage: 0.02 mm rechts, 0.06 mm hoch  
 Streuwert: 1.26, horizontal: 1.44, vertikal: 1.04

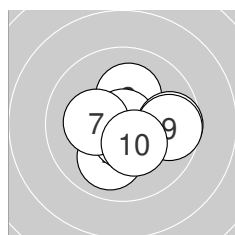
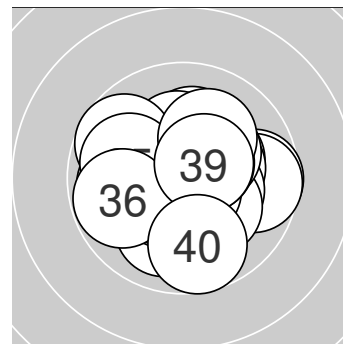

**Serie 1: 102.7 (98)**

10.6* ↖	10.4* ↑	10.2* ↑	10.0 ↓	10.6* ↓
10.9* ↑	10.2* ←	9.7 →	9.7 →	10.4* ↓

beste Teiler: 16.1 (6.), 80.6 (5.), 89.0 (1.)  
 Trefferlage: 0.46 mm rechts, 0.05 mm tief  
 Streuwert: 1.43, horizontal: 1.62, vertikal: 1.20

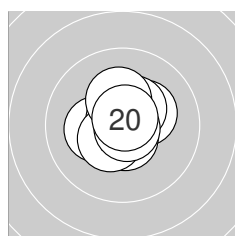

**Serie 2: 105.4 (100)**

10.3* ↗	10.6* ↓	10.2* ←	10.9* →	10.7* ↖
10.4* ↑	10.5* ↙	10.8* ↘	10.3* ↑	10.7* ↑

beste Teiler: 11.1 (14.), 37.2 (18.), 51.5 (20.)  
 Trefferlage: 0.01 mm links, 0.23 mm hoch  
 Streuwert: 0.85, horizontal: 0.86, vertikal: 0.85

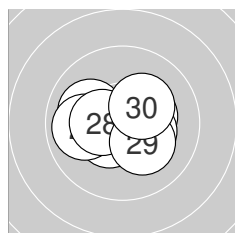

**Serie 3: 103.1 (99)**

10.4* →	10.3* →	10.5* ↙	10.0 ↖	10.3* →
10.8* →	9.9 ←	10.4* ←	10.2* ↘	10.3* ↗

beste Teiler: 44.3 (26.), 119.6 (23.), 137.5 (21.)  
 Trefferlage: 0.03 mm rechts, 0.04 mm tief  
 Streuwert: 1.26, horizontal: 1.63, vertikal: 0.73

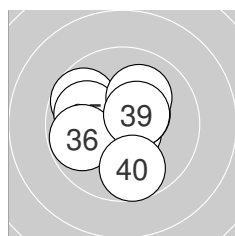

**Serie 4: 102.4 (96)**

10.8* ↙	10.7* ↘	10.7* ↑	9.7 ↖	9.9 ←
9.8 ←	10.5* ↗	10.1 ↑	10.5* ↗	9.7 ↓

beste Teiler: 36.1 (31.), 52.0 (33.), 67.0 (32.)  
 Trefferlage: 0.39 mm links, 0.12 mm hoch  
 Streuwert: 1.49, horizontal: 1.59, vertikal: 1.39



Ergebnis: **421.1** (399)  
 Serien: 105.9 105.3 105.7 104.2  
 Zähler: 39 1 0 0 0 0 0 0 0 0  
 Innenzehner: 36  
 Weitester: 266 (38.), 235 (32.), 234 (16.)  
 beste Teiler: 19.6 (21.), 21.0 (13.), 34.3 (29.)  
 Trefferlage: 0.08 mm rechts, 0.00 mm  
 Streuwert: 0.87, horizontal: 0.90, vertikal: 0.85

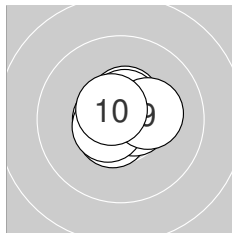
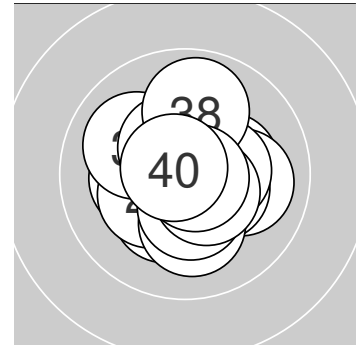

**Serie 1: 105.9 (100)**

10.5* ↑	10.8* ↙	10.6* ←	10.7* ↙	10.6* ↙
10.6* →	10.6* ↙	10.6* ↑	10.3* →	10.6* ↘

beste Teiler: 42.1 (2.), 55.3 (4.), 78.0 (3.)  
 Trefferlage: 0.02 mm links, 0.09 mm hoch  
 Streuwert: 0.72, horizontal: 0.80, vertikal: 0.62

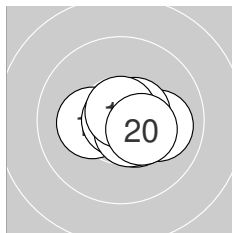

**Serie 2: 105.3 (100)**

10.2* ←	10.5* ↘	10.9* ←	10.6* →	10.8* ↑
10.0 →	10.6* ↘	10.6* →	10.7* ↑	10.4* ↘

beste Teiler: 21.0 (13.), 44.3 (15.), 51.0 (19.)  
 Trefferlage: 0.49 mm rechts, 0.07 mm tief  
 Streuwert: 0.83, horizontal: 1.08, vertikal: 0.48

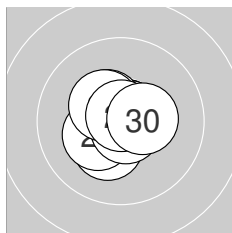

**Serie 3: 105.7 (100)**

10.9* →	10.8* ↗	10.3* ↙	10.7* ↗	10.3* ↙
10.4* ↘	10.7* ↘	10.4* ↘	10.8* ↑	10.4* →

beste Teiler: 19.6 (21.), 34.3 (29.), 49.0 (22.)  
 Trefferlage: 0.14 mm links, 0.03 mm hoch  
 Streuwert: 0.81, horizontal: 0.85, vertikal: 0.77

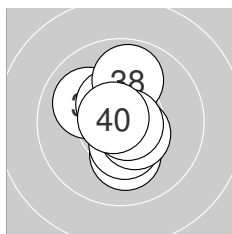

**Serie 4: 104.2 (99)**

10.6* ↘	10.0 ↘	10.5* ↘	10.1 ↓	10.7* ↘
10.4* ↓	10.5* ↘	9.9 ↑	10.8* →	10.7* ↘

beste Teiler: 46.8 (39.), 53.3 (40.), 69.6 (35.)  
 Trefferlage: 0.02 mm rechts, 0.02 mm tief  
 Streuwert: 1.14, horizontal: 0.85, vertikal: 1.37



Ergebnis: **420.5** (400)  
 Serien: 104.3 105.6 105.9 104.7  
 Zähler: 40 0 0 0 0 0 0 0 0 0  
 Innenzehner: 37  
 Weitestе: 233 (7.), 218 (2.), 217 (36.)  
 beste Teiler: 20.2 (14.), 30.6 (23.), 31.2 (24.)  
 Trefferlage: 0.03 mm links, 0.02 mm hoch  
 Streuwert: 0.90, horizontal: 0.81, vertikal: 0.97

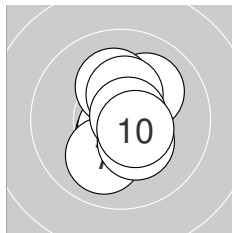
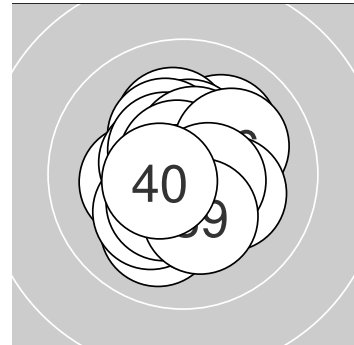

**Serie 1: 104.3 (100)**

10.7* ↓	10.1 ↗	10.6* ↘	10.7* ↘	10.2* ↑
10.4* ↑	10.0 ↘	10.8* ↗	10.3* ↘	10.5* ↘

beste Teiler: 48.7 (8.), 56.0 (1.), 63.0 (4.)  
 Trefferlage: 0.18 mm rechts, 0.08 mm tief  
 Streuwert: 1.08, horizontal: 0.74, vertikal: 1.34

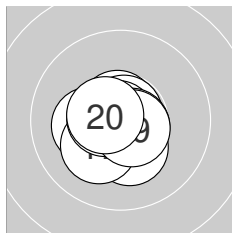

**Serie 2: 105.6 (100)**

10.7* ↑	10.2* ←	10.8* ↗	10.9* ←	10.3* ↓
10.7* ↘	10.2* ↘	10.6* ←	10.6* ↘	10.6* ←

beste Teiler: 20.2 (14.), 42.4 (13.), 68.4 (11.)  
 Trefferlage: 0.32 mm links, 0.26 mm tief  
 Streuwert: 0.80, horizontal: 0.85, vertikal: 0.75

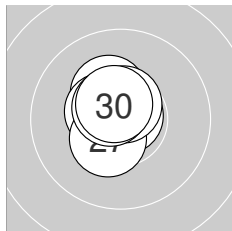

**Serie 3: 105.9 (100)**

10.8* ↑	10.5* ↘	10.8* ↑	10.8* ↗	10.3* ↑
10.5* ←	10.4* ↘	10.6* ↑	10.6* ↘	10.6* ↑

beste Teiler: 30.6 (23.), 31.2 (24.), 36.6 (21.)  
 Trefferlage: 0.40 mm links, 0.49 mm hoch  
 Streuwert: 0.57, horizontal: 0.43, vertikal: 0.68

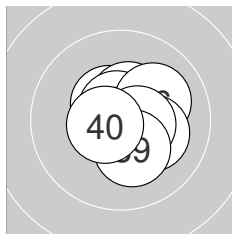

**Serie 4: 104.7 (100)**

10.5* ↘	10.5* ↑	10.7* ↑	10.8* ↘	10.6* ↓
10.1 ↗	10.2* ↘	10.5* →	10.2* ↓	10.6* ←

beste Teiler: 36.2 (34.), 67.0 (33.), 88.2 (35.)  
 Trefferlage: 0.39 mm rechts, 0.02 mm tief  
 Streuwert: 0.95, horizontal: 0.95, vertikal: 0.95



**Ergebnis: 414.2 (395)**  
**Serien: 104.1 102.1 104.7 103.3**  
**Zähler: 35 5 0 0 0 0 0 0 0 0 0**  
**Innenzehner: 30**  
**Weiteste: 478 (18.), 303 (39.), 298 (21.)**  
**beste Teiler: 29.6 (26.), 32.0 (2.), 44.3 (7.)**  
**Trefferlage: 0.02 mm rechts, 0.13 mm hoch**  
**Streuwert: 1.26, horizontal: 1.32, vertikal: 1.20**

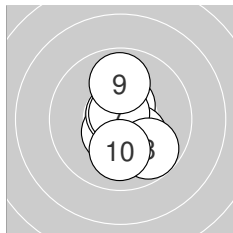
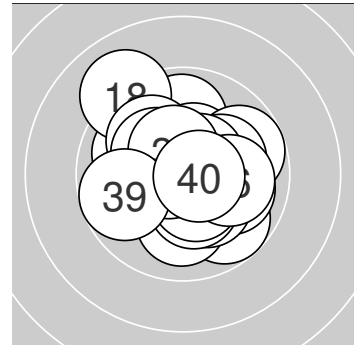

**Serie 1: 104.1 (98)**

10.7* ↓	10.8* ↑	10.5* ↑	10.3* ↘	10.5* ↙
10.8* ↘	10.8* ↑	9.8 ↘	9.9 ↑	10.0 ↓

**beste Teiler: 32.0 (2.), 44.3 (7.), 49.6 (6.)**  
**Trefferlage: 0.22 mm rechts, 0.25 mm tief**  
**Streuwert: 1.21, horizontal: 0.79, vertikal: 1.51**

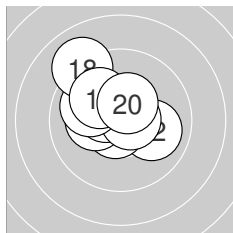

**Serie 2: 102.1 (99)**

10.5* ↘	10.0 →	10.7* ↙	10.2* ←	10.5* ↘
10.7* →	10.0 ↘	9.0 ↘	10.1 ↘	10.4* ↑

**beste Teiler: 69.3 (13.), 73.2 (16.), 117.3 (11.)**  
**Trefferlage: 0.72 mm links, 0.79 mm hoch**  
**Streuwert: 1.44, horizontal: 1.55, vertikal: 1.32**

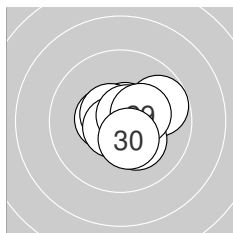

**Serie 3: 104.7 (99)**

9.8 →	10.5* ←	10.7* ↗	10.2* ↘	10.6* ↘
10.8* ↘	10.7* ↙	10.7* ↗	10.3* →	10.4* ↘

**beste Teiler: 29.6 (26.), 61.5 (28.), 68.4 (23.)**  
**Trefferlage: 0.45 mm rechts, 0.01 mm hoch**  
**Streuwert: 1.00, horizontal: 1.15, vertikal: 0.83**

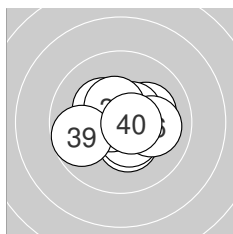

**Serie 4: 103.3 (99)**

10.2* →	10.3* ↓	10.5* ↗	10.5* ↓	10.3* ↘
10.0 →	10.7* ←	10.5* ↘	9.7 ←	10.6* →

**beste Teiler: 69.2 (37.), 79.6 (40.), 107.5 (33.)**  
**Trefferlage: 0.15 mm rechts, 0.02 mm tief**  
**Streuwert: 1.26, horizontal: 1.52, vertikal: 0.92**



**Ergebnis: 407.3 (390)**  
**Serien: 103.3 99.4 102.3 102.3**  
**Zähler: 30 10 0 0 0 0 0 0 0 0 0**  
**Innenzehner: 19**  
**Weiteste: 372 (11.), 336 (19.), 333 (15.)**  
**beste Teiler: 14.5 (28.), 48.3 (36.), 50.2 (23.)**  
**Trefferlage: 0.12 mm links, 0.38 mm hoch**  
**Streuwert: 1.48, horizontal: 1.69, vertikal: 1.24**

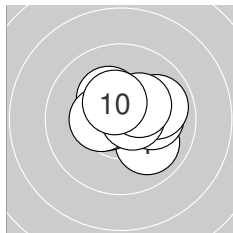
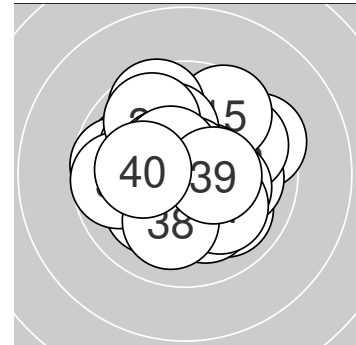

**Serie 1: 103.3 (99)**

10.0 ↘	10.3* ↖	10.6* ↗	10.6* ←	10.1 →
9.9 ↗	10.4* ←	10.6* →	10.3* ↗	10.5* ↖

**beste Teiler: 83.6 (8.), 84.3 (3.), 97.1 (4.)**  
**Trefferlage: 0.56 mm rechts, 0.37 mm hoch**  
**Streuwert: 1.16, horizontal: 1.39, vertikal: 0.87**

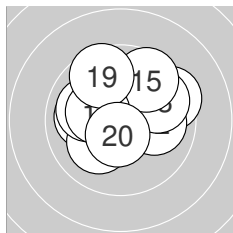

**Serie 2: 99.4 (96)**

9.5 ↗	10.0 →	9.8 ↗	10.0 ←	9.6 ↗
10.1 ↖	10.0 ←	10.3* ←	9.6 ↖	10.5* ↓

**beste Teiler: 103.1 (20.), 170.1 (18.), 212.1 (16.)**  
**Trefferlage: 0.08 mm rechts, 0.76 mm hoch**  
**Streuwert: 1.89, horizontal: 2.22, vertikal: 1.49**

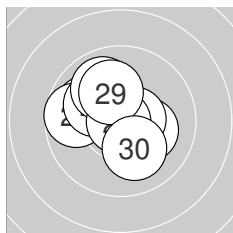

**Serie 3: 102.3 (97)**

10.2* ↘	9.9 ↖	10.8* ↗	10.6* →	9.7 ←
10.1 ↖	9.9 ↖	10.9* ←	10.1 ↖	10.1 ↘

**beste Teiler: 14.5 (28.), 50.2 (23.), 93.0 (24.)**  
**Trefferlage: 0.52 mm links, 0.47 mm hoch**  
**Streuwert: 1.41, horizontal: 1.58, vertikal: 1.21**

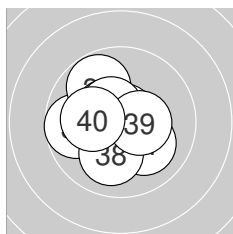

**Serie 4: 102.3 (98)**

10.1 ↘	9.7 ←	10.3* ↓	9.8 ↖	10.5* ↖
10.8* ↗	10.5* ↖	10.0 ↓	10.4* →	10.2* ←

**beste Teiler: 48.3 (36.), 112.4 (37.), 123.4 (35.)**  
**Trefferlage: 0.63 mm links, 0.06 mm tief**  
**Streuwert: 1.39, horizontal: 1.42, vertikal: 1.35**



Ergebnis: **415.6** (398)  
 Serien: 102.5 105.2 103.9 104.0  
 Zähler: 38 2 0 0 0 0 0 0 0 0  
 Innenzehner: 33  
 Weitesten: 324 (24.), 322 (4.), 247 (23.)  
 beste Teiler: 8.0 (20.), 10.1 (28.), 11.1 (15.)  
 Trefferlage: 0.17 mm links, 0.37 mm hoch  
 Streuwert: 1.11, horizontal: 1.20, vertikal: 1.01

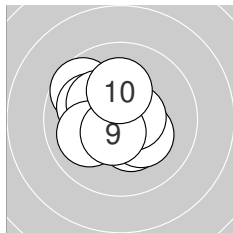
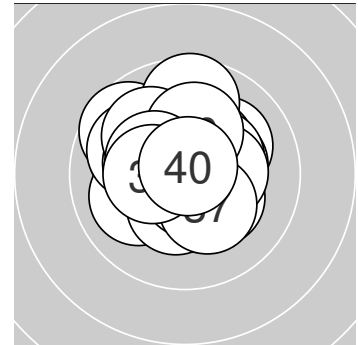

**Serie 1: 102.5 (99)**

10.4* ↘	10.3* ↘	10.6* ↑	9.7 ↘	10.6* →
10.0 ↖	10.2* ↖	10.0 ←	10.5* ↙	10.2* ↑

beste Teiler: 76.0 (3.), 86.9 (5.), 102.5 (9.)  
 Trefferlage: 0.59 mm links, 0.25 mm hoch  
 Streuwert: 1.33, horizontal: 1.40, vertikal: 1.26

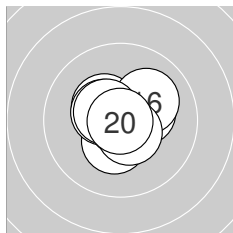

**Serie 2: 105.2 (100)**

10.3* →	10.8* →	10.4* ↓	10.4* ↘	10.9* ↙
10.1 ↗	10.4* ↖	10.5* ↘	10.5* ↖	10.9* ↙

beste Teiler: 8.0 (20.), 11.1 (15.), 50.9 (12.)  
 Trefferlage: 0.05 mm rechts, 0.12 mm hoch  
 Streuwert: 0.93, horizontal: 1.03, vertikal: 0.82

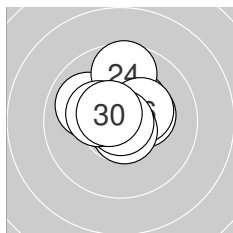

**Serie 3: 103.9 (99)**

10.3* →	10.3* ↗	10.0 ↖	9.7 ↑	10.8* ←
10.3* ↗	10.7* ↘	10.9* ↓	10.3* ↖	10.6* ↖

beste Teiler: 10.1 (28.), 42.4 (25.), 70.9 (27.)  
 Trefferlage: 0.05 mm links, 0.70 mm hoch  
 Streuwert: 1.13, horizontal: 1.21, vertikal: 1.05

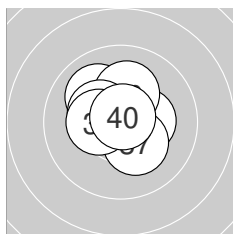

**Serie 4: 104.0 (100)**

10.8* ←	10.5* ↖	10.4* →	10.3* →	10.0 ↘
10.2* ↑	10.3* ↘	10.3* ↖	10.4* ←	10.8* ↑

beste Teiler: 38.6 (40.), 41.3 (31.), 117.3 (32.)  
 Trefferlage: 0.11 mm links, 0.42 mm hoch  
 Streuwert: 1.08, horizontal: 1.19, vertikal: 0.95



Ergebnis: **422.2** (400)  
 Serien: 105.1 105.6 106.3 105.2  
 Zähler: 40 0 0 0 0 0 0 0 0 0  
 Innenzehner: 40  
 Weitestе: 193 (32.), 189 (4.), 179 (33.)  
 beste Teiler: 16.0 (13.), 19.0 (28.), 19.4 (38.)  
 Trefferlage: 0.04 mm links, 0.32 mm tief  
 Streuwert: 0.77, horizontal: 0.75, vertikal: 0.78

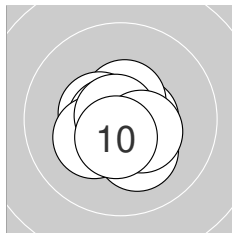
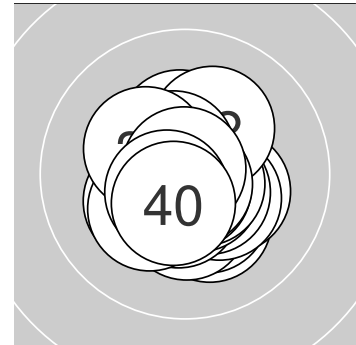

**Serie 1: 105.1 (100)**

10.6* →	10.5* ↑	10.5* ←	10.2* ↓	10.6* ↙
10.7* ←	10.3* ↗	10.8* ↘	10.4* →	10.5* ↓

beste Teiler: 34.4 (8.), 64.0 (6.), 77.8 (5.)  
 Trefferlage: 0.09 mm links, 0.34 mm tief  
 Streuwert: 0.83, horizontal: 0.88, vertikal: 0.79

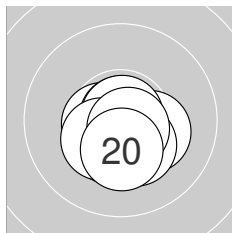

**Serie 2: 105.6 (100)**

10.6* ←	10.8* ↓	10.9* ↑	10.3* →	10.3* ↘
10.9* ↑	10.4* ↙	10.4* ↗	10.7* ↘	10.3* ↓

beste Teiler: 16.0 (13.), 20.6 (16.), 31.0 (12.)  
 Trefferlage: 0.05 mm rechts, 0.64 mm tief  
 Streuwert: 0.71, horizontal: 0.78, vertikal: 0.63

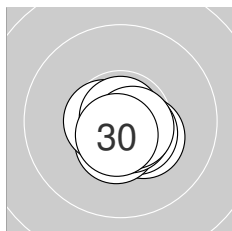

**Serie 3: 106.3 (100)**

10.8* ↓	10.7* ←	10.3* ↘	10.5* ↘	10.5* ↓
10.6* ←	10.7* ↘	10.9* ↑	10.7* →	10.6* ↓

beste Teiler: 19.0 (28.), 39.4 (21.), 54.0 (22.)  
 Trefferlage: 0.15 mm rechts, 0.44 mm tief  
 Streuwert: 0.55, horizontal: 0.65, vertikal: 0.43

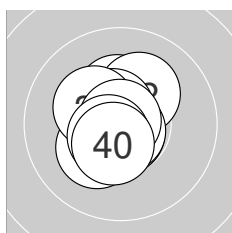

**Serie 4: 105.2 (100)**

10.3* ↑	10.2* ↗	10.2* ↘	10.6* ↘	10.3* ↘
10.8* ↓	10.8* ↓	10.9* ↑	10.6* ↗	10.5* ↓

beste Teiler: 19.4 (38.), 41.1 (37.), 50.5 (36.)  
 Trefferlage: 0.30 mm links, 0.12 mm hoch  
 Streuwert: 0.90, horizontal: 0.72, vertikal: 1.05





**Ergebnis: 412.8 (395)**  
**Serien: 104.2 101.7 102.9 104.0**  
**Zähler: 36 3 1 0 0 0 0 0 0 0**  
**Innenzehner: 32**  
**Weiteste: 576 (13.), 437 (16.), 292 (24.)**  
**beste Teiler: 26.0 (8.), 36.4 (21.), 38.2 (34.)**  
**Trefferlage: 0.34 mm links, 0.10 mm tief**  
**Streuwert: 1.34, horizontal: 1.68, vertikal: 0.86**

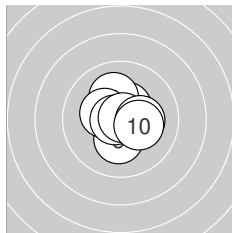
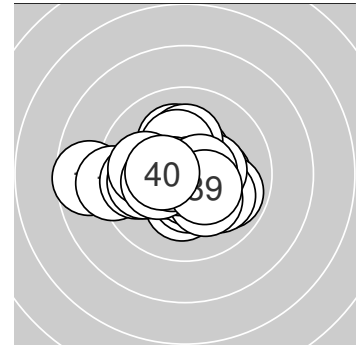

**Serie 1: 104.2 (100)**

10.5* ↗	10.6* ↘	10.5* ↗	10.1 ↖	10.2* ↓
10.3* ↖	10.7* ←	10.8* ↗	10.2* →	10.3* ↘

**beste Teiler: 26.0 (8.), 53.3 (7.), 99.0 (2.)**  
**Trefferlage: 0.16 mm rechts, 0.27 mm hoch**  
**Streuwert: 1.03, horizontal: 1.04, vertikal: 1.01**

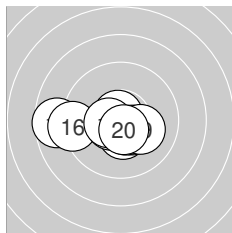

**Serie 2: 101.7 (97)**

10.7* ↘	10.4* ↓	8.6 ←	10.4* ↘	10.5* ↘
9.2 ←	10.6* ↙	10.5* ←	10.2* →	10.6* ↓

**beste Teiler: 52.3 (11.), 90.4 (20.), 97.5 (17.)**  
**Trefferlage: 0.84 mm links, 0.58 mm tief**  
**Streuwert: 1.73, horizontal: 2.39, vertikal: 0.49**

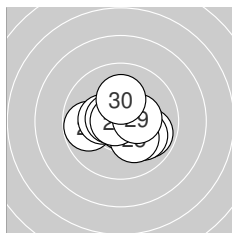

**Serie 3: 102.9 (98)**

10.8* ↓	9.9 ↘	10.0 ↘	9.8 ←	10.2* ↘
10.3* ←	10.6* ←	10.7* ←	10.4* →	10.2* ↑

**beste Teiler: 36.4 (21.), 51.0 (28.), 98.4 (27.)**  
**Trefferlage: 0.13 mm rechts, 0.20 mm tief**  
**Streuwert: 1.39, horizontal: 1.70, vertikal: 1.00**

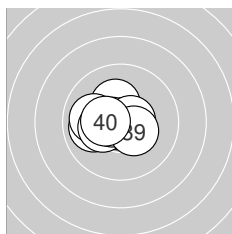

**Serie 4: 104.0 (100)**

10.5* ↖	10.3* ↑	10.0 ←	10.8* ↙	10.0 ←
10.3* ←	10.7* ←	10.6* →	10.4* ↘	10.4* ←

**beste Teiler: 38.2 (34.), 75.0 (37.), 92.2 (38.)**  
**Trefferlage: 0.83 mm links, 0.07 mm hoch**  
**Streuwert: 0.99, horizontal: 1.23, vertikal: 0.68**



# LG 40 AUT Senioren

StandNr: 16

Sinzinger, Elke #216

# Frauen

Wertung

StartNr: 220

21.03.2024 14:02

OÖ – SV Frankenburg

Ergebnis: **408.3** (392)  
 Serien: 102.8 100.2 101.2 104.1  
 Zähler: 32 8 0 0 0 0 0 0 0 0  
 Innenzehner: 23  
 Weitester: 419 (14.), 373 (25.), 364 (18.)  
 beste Teiler: 21.5 (1.), 53.1 (34.), 67.6 (40.)  
 Trefferlage: 0.09 mm rechts, 0.10 mm hoch  
 Streuwert: 1.50, horizontal: 1.67, vertikal: 1.32

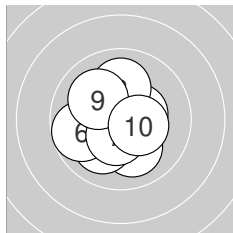
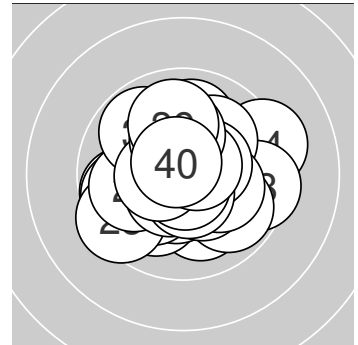

### Serie 1: 102.8 (99)

10.9* ↓	10.4* →	10.6* ↙	10.1 ↓	10.1 ↗
9.7 ←	10.5* ↓	10.0 ↑	10.1 ↘	10.4* →

beste Teiler: 21.5 (1.), 84.6 (3.), 123.4 (7.)  
 Trefferlage: 0.31 mm links, 0.31 mm tief  
 Streuwert: 1.36, horizontal: 1.35, vertikal: 1.38

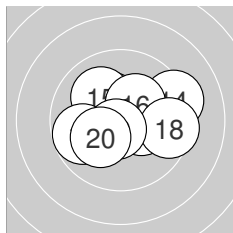

### Serie 2: 100.2 (96)

10.3* →	10.3* ↘	9.7 →	9.3 →	10.1 ↘
10.3* ↗	9.8 ←	9.5 →	10.7* ↙	10.2* ↗

beste Teiler: 74.6 (19.), 158.2 (12.), 158.6 (11.)  
 Trefferlage: 0.64 mm rechts, 0.20 mm hoch  
 Streuwert: 1.87, horizontal: 2.38, vertikal: 1.14

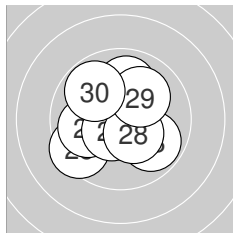

### Serie 3: 101.2 (97)

10.6* →	10.5* →	9.8 ↘	10.0 ↑	9.5 ↙
10.0 ←	10.5* ↗	10.4* ↘	10.1 ↗	9.8 ↘

beste Teiler: 93.9 (21.), 107.0 (27.), 109.4 (22.)  
 Trefferlage: 0.11 mm links, 0.00 mm  
 Streuwert: 1.70, horizontal: 1.80, vertikal: 1.59

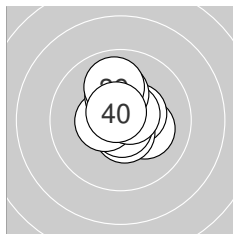

### Serie 4: 104.1 (100)

10.2* →	10.4* →	10.6* ↓	10.7* ↓	10.5* ←
10.6* ↗	10.2* ↑	10.2* ↑	10.0 ↑	10.7* ↘

beste Teiler: 53.1 (34.), 67.6 (40.), 81.5 (36.)  
 Trefferlage: 0.15 mm rechts, 0.54 mm hoch  
 Streuwert: 1.03, horizontal: 0.87, vertikal: 1.16



**Ergebnis: 417.9 (398)**  
**Serien: 103.5 104.8 105.2 104.4**  
**Zähler: 38 2 0 0 0 0 0 0 0 0**  
**Innenzehner: 37**  
**Weiteste: 311 (6.), 301 (35.), 238 (32.)**  
**beste Teiler: 26.3 (29.), 30.2 (40.), 35.1 (39.)**  
**Trefferlage: 0.29 mm links, 0.14 mm hoch**  
**Streuwert: 0.98, horizontal: 1.20, vertikal: 0.69**

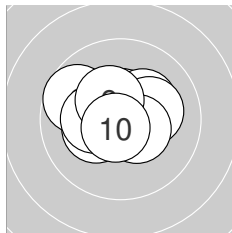
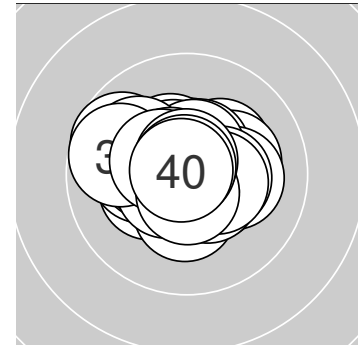

**Serie 1: 103.5 (99)**

10.7* →	10.3* ←	10.5* ↑	10.2* ↗	10.2* →
9.7 ↖	10.3* ←	10.5* ↘	10.4* ↖	10.7* ↙

**beste Teiler: 63.3 (1.), 64.1 (10.), 106.2 (3.)**  
**Trefferlage: 0.20 mm links, 0.35 mm hoch**  
**Streuwert: 1.21, horizontal: 1.51, vertikal: 0.79**

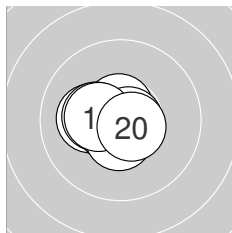

**Serie 2: 104.8 (100)**

10.3* ←	10.6* ↑	10.2* ←	10.5* ←	10.3* ←
10.7* ↗	10.5* ↓	10.7* →	10.4* ←	10.6* ↘

**beste Teiler: 51.4 (18.), 75.7 (16.), 78.9 (12.)**  
**Trefferlage: 0.73 mm links, 0.04 mm tief**  
**Streuwert: 0.76, horizontal: 0.95, vertikal: 0.49**

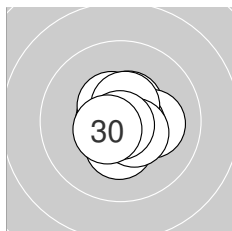

**Serie 3: 105.2 (100)**

10.7* ←	10.5* ↑	10.2* →	10.7* →	10.5* ↖
10.5* ↑	10.3* ↓	10.5* ↘	10.8* ↓	10.5* ↗

**beste Teiler: 26.3 (29.), 68.4 (21.), 70.5 (24.)**  
**Trefferlage: 0.21 mm rechts, 0.03 mm tief**  
**Streuwert: 0.85, horizontal: 0.86, vertikal: 0.85**

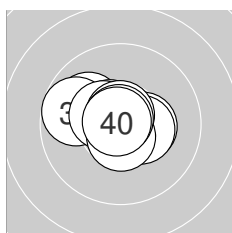

**Serie 4: 104.4 (99)**

10.4* →	10.0 ↖	10.6* ↖	10.4* →	9.7 ←
10.4* ↖	10.6* ↓	10.7* ↑	10.8* ↖	10.8* ↖

**beste Teiler: 30.2 (40.), 35.1 (39.), 59.1 (38.)**  
**Trefferlage: 0.44 mm links, 0.29 mm hoch**  
**Streuwert: 1.04, horizontal: 1.35, vertikal: 0.60**



# LG 40 AUT Senioren

StandNr: 18

Zehetner, Anita #218

# Frauen

Wertung

NÖ – SPS Leonhofen / Niederösterreich 1

StartNr: 222

21.03.2024 14:11

Ergebnis: **419.2** (399)  
 Serien: 104.7 104.2 105.2 105.1  
 Zähler: 39 1 0 0 0 0 0 0 0 0  
 Innenzehner: 36  
 Weitester: 271 (13.), 222 (36.), 221 (30.)  
 beste Teiler: 22.2 (8.), 24.0 (22.), 27.2 (4.)  
 Trefferlage: 0.12 mm links, 0.30 mm tief  
 Streuwert: 0.93, horizontal: 1.16, vertikal: 0.62

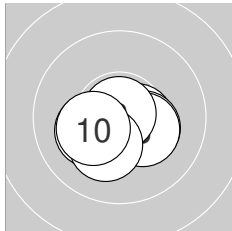
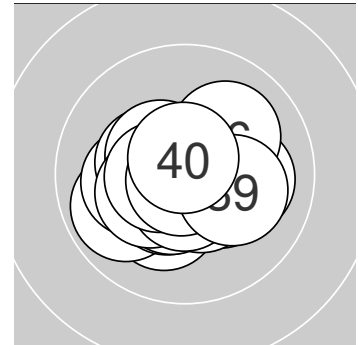

### Serie 1: 104.7 (100)

10.5* →	10.2* ↙	10.3* ↘	10.8* ↙	10.8* ↓
10.3* ↘	10.4* ↙	10.9* ↑	10.2* ↙	10.3* ↙

beste Teiler: 22.2 (8.), 27.2 (4.), 49.0 (5.)  
 Trefferlage: 0.15 mm links, 0.60 mm tief  
 Streuwert: 0.89, horizontal: 1.16, vertikal: 0.51

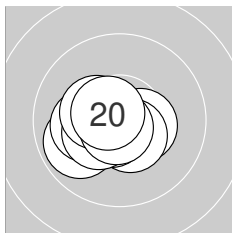

### Serie 2: 104.2 (99)

10.4* ←	10.4* →	9.9 ↙	10.5* ↘	10.2* ←
10.6* ↙	10.4* ↙	10.4* ←	10.8* ↙	10.6* ↘

beste Teiler: 49.2 (19.), 80.9 (16.), 83.8 (20.)  
 Trefferlage: 0.78 mm links, 0.35 mm tief  
 Streuwert: 0.90, horizontal: 1.13, vertikal: 0.59

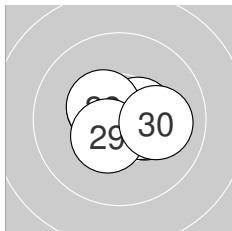

### Serie 3: 105.2 (100)

10.7* →	10.9* ↘	10.8* ↙	10.3* →	10.4* →
10.5* →	10.5* ↘	10.5* ↘	10.5* ↙	10.1 →

beste Teiler: 24.0 (22.), 42.1 (23.), 55.1 (21.)  
 Trefferlage: 0.37 mm rechts, 0.02 mm tief  
 Streuwert: 0.88, horizontal: 1.13, vertikal: 0.51

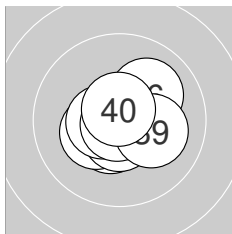

### Serie 4: 105.1 (100)

10.8* ↓	10.5* ↙	10.7* ↘	10.3* ↙	10.6* ↓
10.1 ↗	10.5* ←	10.8* ↙	10.1 →	10.7* ↑

beste Teiler: 29.1 (38.), 37.2 (31.), 63.1 (33.)  
 Trefferlage: 0.07 mm rechts, 0.22 mm tief  
 Streuwert: 0.92, horizontal: 1.05, vertikal: 0.77



**LG 40 AUT Senioren**

StandNr: 19

**Jablonowska, Renata** #219

**Frauen**

Wertung

**StartNr: 223**

21.03.2024 15:28

B – SSV Breitenbrunn

Ergebnis: **0.0** (0)<sub>DNS</sub>  
Serien:  
Zähler: 0 0 0 0 0 0 0 0 0 0 0  
Innenzehner: 0  
Weiteste:  
~~beste Teiler~~Schütze ist nicht zum Wettkampf angetreten  
Trefferlage: 0.00 mm , 0.00 mm  
Streuwert:

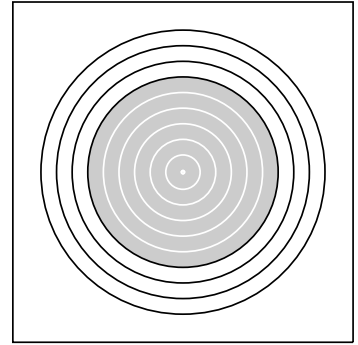

Ergebnis: **421.2** (399)  
 Serien: 104.1 105.7 105.4 106.0  
 Zähler: 39 1 0 0 0 0 0 0 0 0  
 Innenzehner: 36  
 Weitestе: 261 (34.), 232 (6.), 220 (21.)  
 beste Teiler: 8.9 (14.), 10.6 (30.), 14.8 (35.)  
 Trefferlage: 0.18 mm links, 0.26 mm tief  
 Streuwert: 0.85, horizontal: 0.97, vertikal: 0.72

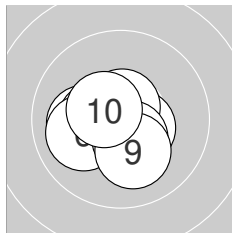
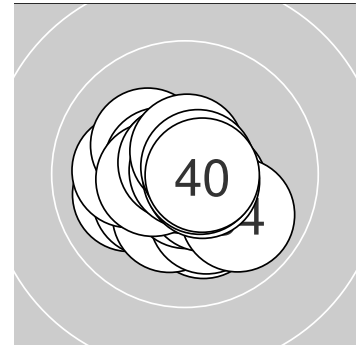

**Serie 1: 104.1 (100)**

10.8* ↙	10.1 ←	10.5* ←	10.4* ←	10.5* ↘
10.0 ←	10.7* ↑	10.4* ↓	10.2* ↓	10.5* ↘

beste Teiler: 49.9 (1.), 72.5 (7.), 101.4 (3.)  
 Trefferlage: 0.55 mm links, 0.36 mm tief  
 Streuwert: 0.99, horizontal: 1.16, vertikal: 0.78

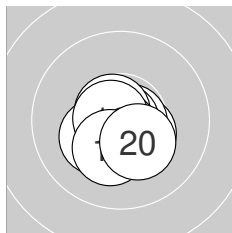

**Serie 2: 105.7 (100)**

10.4* ↘	10.7* →	10.3* ↗	10.9* ↓	10.7* ←
10.7* ↘	10.7* ↓	10.7* ←	10.3* ↓	10.3* ↘

beste Teiler: 8.9 (14.), 52.1 (12.), 52.9 (15.)  
 Trefferlage: 0.09 mm links, 0.50 mm tief  
 Streuwert: 0.72, horizontal: 0.77, vertikal: 0.66

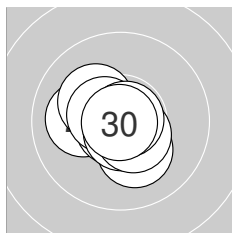

**Serie 3: 105.4 (100)**

10.1 ←	10.8* ↗	10.2* ↘	10.2* ↓	10.7* ↗
10.5* ↘	10.7* ↓	10.5* ↘	10.8* →	10.9* ↗

beste Teiler: 10.6 (30.), 28.2 (22.), 32.8 (29.)  
 Trefferlage: 0.33 mm links, 0.20 mm tief  
 Streuwert: 0.87, horizontal: 0.96, vertikal: 0.76

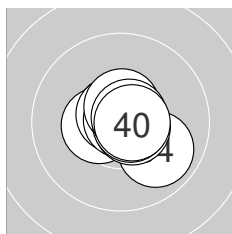

**Serie 4: 106.0 (99)**

10.7* ↘	10.4* ←	10.7* ↘	9.9 ↘	10.9* ↑
10.6* ↑	10.7* ↘	10.7* →	10.7* →	10.7* →

beste Teiler: 14.8 (35.), 58.6 (39.), 60.1 (31.)  
 Trefferlage: 0.26 mm rechts, 0.00 mm  
 Streuwert: 0.78, horizontal: 0.89, vertikal: 0.67



Ergebnis: **411.0** (389)  
 Serien: 104.4 102.8 101.0 102.8  
 Zähler: 29 11 0 0 0 0 0 0 0 0  
 Innenzehner: 27  
 Weitester: 404 (24.), 355 (29.), 331 (19.)  
 beste Teiler: 9.8 (10.), 17.0 (11.), 21.2 (28.)  
 Trefferlage: 0.43 mm links, 0.55 mm hoch  
 Streuwert: 1.32, horizontal: 1.31, vertikal: 1.34

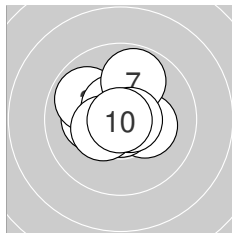
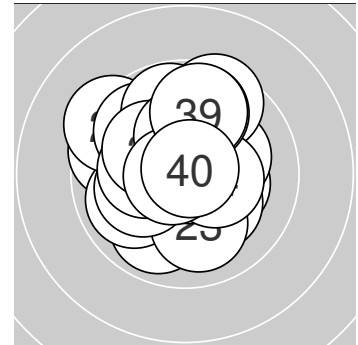

**Serie 1: 104.4 (98)**

10.3* →	10.2* ←	9.9 ↘	10.8* ↓	10.8* ↑
10.6* ↘	9.8 ↑	10.4* ←	10.7* →	10.9* ↘

beste Teiler: 9.8 (10.), 28.1 (5.), 38.0 (4.)  
 Trefferlage: 0.26 mm links, 0.35 mm hoch  
 Streuwert: 1.13, horizontal: 1.24, vertikal: 1.00

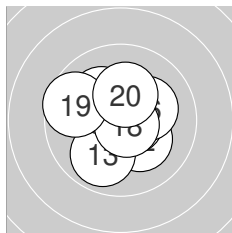

**Serie 2: 102.8 (98)**

10.9* →	10.2* ↘	9.9 ↙	10.7* →	10.2* ↘
10.2* →	10.2* ↘	10.7* ↘	9.6 ↖	10.2* ↑

beste Teiler: 17.0 (11.), 52.2 (18.), 74.5 (14.)  
 Trefferlage: 0.21 mm links, 0.23 mm hoch  
 Streuwert: 1.40, horizontal: 1.48, vertikal: 1.31

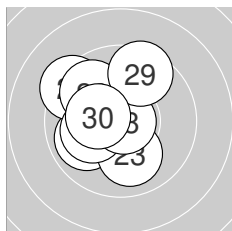

**Serie 3: 101.0 (96)**

10.5* ←	9.9 ↙	10.0 ↓	9.3 ↖	10.7* ↘
9.8 ↘	10.1 ←	10.9* →	9.5 ↑	10.3* ←

beste Teiler: 21.2 (28.), 64.4 (25.), 107.2 (21.)  
 Trefferlage: 1.04 mm links, 0.44 mm hoch  
 Streuwert: 1.57, horizontal: 1.46, vertikal: 1.67

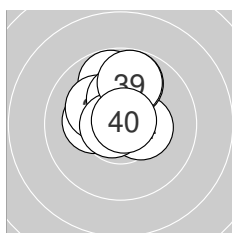

**Serie 4: 102.8 (97)**

10.8* ↑	10.2* ←	9.8 ↑	10.4* →	10.2* ↘
9.8 ↑	10.3* ↑	10.7* ←	9.8 ↑	10.8* ↗

beste Teiler: 33.9 (40.), 45.1 (31.), 59.5 (38.)  
 Trefferlage: 0.19 mm links, 1.19 mm hoch  
 Streuwert: 1.14, horizontal: 1.00, vertikal: 1.26

