

Ergebnis: **385.0** (365)
 Serien: 94.0 97.1 96.6 97.3
 Zähler: 9 27 4 0 0 0 0 0 0 0
 Innenzehner: 6
 Weitester: 689 (5.), 596 (3.), 593 (31.)
 beste Teiler: 34.9 (14.), 35.3 (7.), 77.6 (36.)
 Trefferlage: 0.23 mm rechts, 0.43 mm tief
 Streuwert: 2.58, horizontal: 2.89, vertikal: 2.24

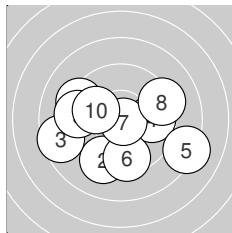
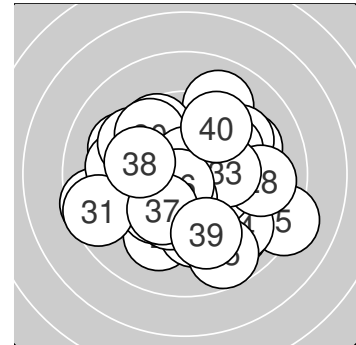

Serie 1: 94.0 (90)

9.3 ↖	9.3 ↓	8.6 ←	9.8 →	8.2 ↘
9.5 ↓	10.8* ↘	9.2 →	9.3 ←	10.0 ↖

beste Teiler: 35.3 (7.), 249.6 (10.), 299.0 (4.)
 Trefferlage: 0.36 mm links, 0.77 mm tief
 Streuwert: 3.12, horizontal: 3.87, vertikal: 2.12

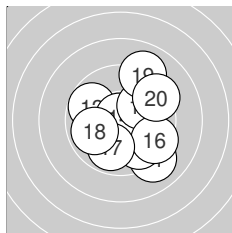

Serie 2: 97.1 (92)

9.1 ↘	9.7 ↖	9.8 ↘	10.8* ↖	10.0 ↗
9.5 ↘	9.9 ↓	9.9 ←	9.0 ↗	9.4 ↗

beste Teiler: 34.9 (14.), 234.6 (15.), 266.3 (18.)
 Trefferlage: 0.91 mm rechts, 0.19 mm tief
 Streuwert: 2.41, horizontal: 2.31, vertikal: 2.50

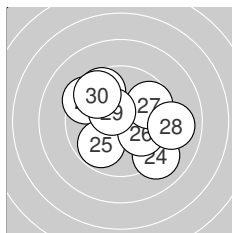

Serie 3: 96.6 (92)

9.6 ↖	9.4 ↖	9.8 →	9.1 ↘	9.8 ↗
10.1 ↘	9.7 ↗	9.0 →	10.5* ↖	9.6 ↖

beste Teiler: 122.4 (29.), 222.8 (26.), 283.7 (25.)
 Trefferlage: 0.58 mm rechts, 0.30 mm hoch
 Streuwert: 2.48, horizontal: 2.86, vertikal: 2.03

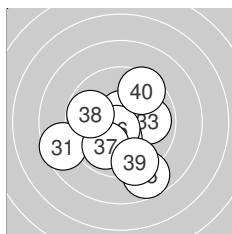

Serie 4: 97.3 (91)

8.6 ←	10.6* ↑	9.9 →	10.3* ↓	8.7 ↘
10.6* ↗	9.9 ↗	9.8 ↖	9.4 ↓	9.5 ↗

beste Teiler: 77.6 (36.), 78.2 (32.), 156.4 (34.)
 Trefferlage: 0.19 mm links, 1.07 mm tief
 Streuwert: 2.45, horizontal: 2.54, vertikal: 2.36



Ergebnis: **386.5** (371)
 Serien: 98.7 96.4 96.6 94.8
 Zähler: 18 16 5 1 0 0 0 0 0 0
 Innenzehner: 12
 Weitester: 976 (36.), 658 (23.), 658 (27.)
 beste Teiler: 7.0 (21.), 75.5 (22.), 115.4 (31.)
 Trefferlage: 0.47 mm links, 0.86 mm hoch
 Streuwert: 2.58, horizontal: 3.09, vertikal: 1.94

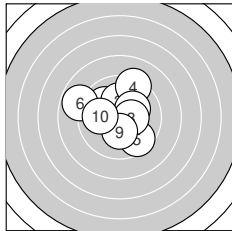
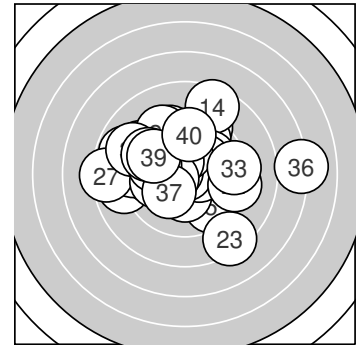

Serie 1: 98.7 (96)

10.1 ↗ 10.0 ↘ 10.1 ↑ 9.3 ↗ 9.6 ↘
 8.8 ↖ 10.2* ↗ 10.4* → 10.2* ↓ 10.0 ←
 beste Teiler: 145.1 (8.), 176.0 (9.), 192.5 (7.)
 Trefferlage: 0.16 mm links, 0.80 mm hoch
 Streuwert: 2.13, horizontal: 2.29, vertikal: 1.95

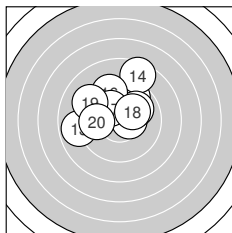

Serie 2: 96.4 (92)

10.5* → 9.6 ↗ 8.9 ← 8.5 ↗ 10.0 ↗
 9.5 ↘ 10.2* ↘ 10.2* ↗ 9.2 ↖ 9.8 ←
 beste Teiler: 120.4 (11.), 185.8 (17.), 193.5 (18.)
 Trefferlage: 0.53 mm links, 1.69 mm hoch
 Streuwert: 2.35, horizontal: 2.67, vertikal: 1.98

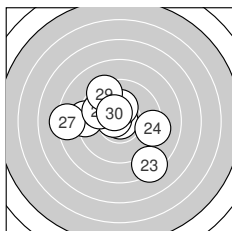

Serie 3: 96.6 (92)

10.9* → 10.7* ↖ 8.3 ↘ 9.2 → 10.3* ↑
 9.2 ← 8.3 ← 9.8 ↖ 9.4 ↘ 10.5* ↘
 beste Teiler: 7.0 (21.), 75.5 (22.), 124.8 (30.)
 Trefferlage: 0.86 mm links, 0.17 mm hoch
 Streuwert: 2.84, horizontal: 3.28, vertikal: 2.31

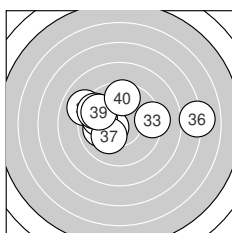

Serie 4: 94.8 (91)

10.5* ← 10.0 ← 9.3 → 9.0 ↖ 9.9 ←
 7.0 → 10.2* ↗ 9.6 ↖ 9.7 ↖ 9.6 ↑
 beste Teiler: 115.4 (31.), 197.4 (37.), 244.7 (32.)
 Trefferlage: 0.31 mm links, 0.79 mm hoch
 Streuwert: 3.15, horizontal: 4.23, vertikal: 1.40



Ergebnis: **391.8** (373)
 Serien: 99.7 98.7 96.7 96.7
 Zähler: 17 19 4 0 0 0 0 0 0 0
 Innenzehner: 15
 Weitester: 695 (30.), 543 (18.), 524 (28.)
 beste Teiler: 49.0 (21.), 51.6 (35.), 91.4 (2.)
 Trefferlage: 0.33 mm links, 0.03 mm hoch
 Streuwert: 2.34, horizontal: 2.71, vertikal: 1.88

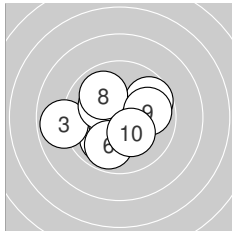
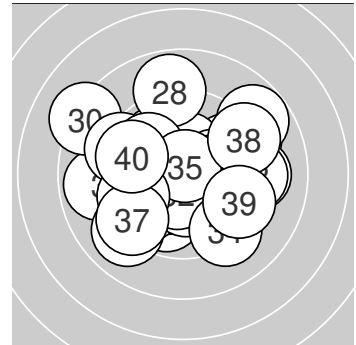

Serie 1: 99.7 (94)

10.0 ↙	10.6* ↙	8.9 ←	10.4* ↖	10.2* ↖
9.9 ↓	9.7 ↗	9.9 ↘	9.9 →	10.2* ↘

beste Teiler: 91.4 (2.), 147.4 (4.), 177.0 (10.)
 Trefferlage: 0.61 mm links, 0.11 mm tief
 Streuwert: 1.97, horizontal: 2.31, vertikal: 1.56

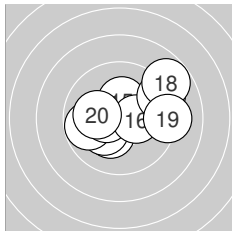

Serie 2: 98.7 (95)

10.3* ↙	10.2* ↙	9.8 ←	10.5* ←	10.3* ↑
10.3* →	9.2 ↗	8.8 ↗	9.2 →	10.1 ←

beste Teiler: 121.0 (14.), 154.2 (16.), 162.3 (15.)
 Trefferlage: 0.59 mm rechts, 0.37 mm hoch
 Streuwert: 2.23, horizontal: 2.77, vertikal: 1.51

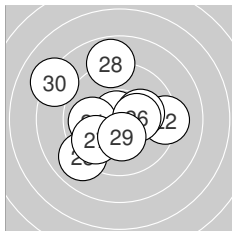

Serie 3: 96.7 (92)

10.8* ↖	9.3 →	10.2* →	9.9 ←	9.0 ↙
10.3* →	9.8 ↙	8.9 ↑	10.3* ↓	8.2 ↖

beste Teiler: 49.0 (21.), 159.6 (26.), 164.2 (29.)
 Trefferlage: 0.74 mm links, 0.23 mm hoch
 Streuwert: 2.75, horizontal: 2.97, vertikal: 2.52

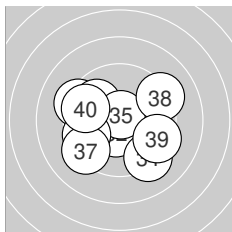

Serie 4: 96.7 (92)

9.3 ↖	10.5* ↓	9.9 ↖	9.2 ↘	10.7* ↑
9.6 ←	9.3 ↙	9.2 ↗	9.4 ↘	9.6 ↖

beste Teiler: 51.6 (35.), 122.8 (32.), 263.2 (33.)
 Trefferlage: 0.56 mm links, 0.36 mm tief
 Streuwert: 2.53, horizontal: 2.97, vertikal: 1.99



Ergebnis: **402.8** (385)
 Serien: 100.2 99.9 101.1 101.6
 Zähler: 28 10 1 1 0 0 0 0 0 0
 Innenzehner: 23
 Weitester: 909 (8.), 719 (14.), 398 (26.)
 beste Teiler: 46.3 (13.), 58.1 (19.), 69.4 (30.)
 Trefferlage: 0.10 mm rechts, 0.26 mm tief
 Streuwert: 1.97, horizontal: 2.44, vertikal: 1.35

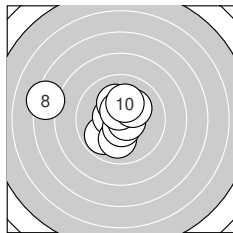
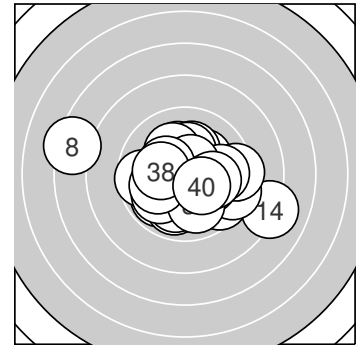

Serie 1: 100.2 (96)

9.9 ↙ 10.5* ↖ 10.0 ↓ 10.6* ↓ 10.7* →
 10.2* ↑ 10.6* ↑ 7.3 ← 10.2* ↗ 10.2* ↑
 beste Teiler: 73.6 (5.), 97.7 (4.), 100.0 (7.)
 Trefferlage: 1.02 mm links, 0.31 mm hoch
 Streuwert: 2.35, horizontal: 2.90, vertikal: 1.62

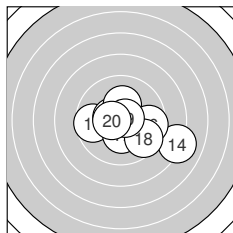

Serie 2: 99.9 (95)

9.6 ← 10.5* ↖ 10.8* → 8.1 → 10.2* ↑
 9.6 → 10.3* ↓ 9.6 ↘ 10.7* ↗ 10.5* ←
 beste Teiler: 46.3 (13.), 58.1 (19.), 103.0 (20.)
 Trefferlage: 0.86 mm rechts, 0.49 mm tief
 Streuwert: 2.17, horizontal: 2.75, vertikal: 1.34

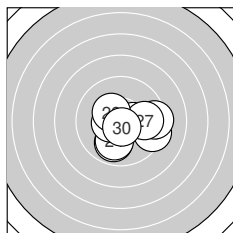

Serie 3: 101.1 (96)

10.6* ↖ 9.9 ↓ 10.4* → 10.0 ↓ 9.4 →
 9.4 → 9.8 → 10.5* ← 10.4* ↖ 10.7* ↓
 beste Teiler: 69.4 (30.), 99.4 (21.), 120.8 (28.)
 Trefferlage: 0.74 mm rechts, 0.52 mm tief
 Streuwert: 1.69, horizontal: 2.07, vertikal: 1.18

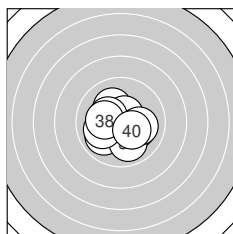

Serie 4: 101.6 (98)

10.1 ↘ 9.9 ↙ 10.6* ↗ 10.2* → 9.9 ↓
 10.3* ↖ 10.0 ← 10.2* ← 10.1 → 10.3* ↘
 beste Teiler: 94.8 (33.), 159.5 (40.), 164.5 (36.)
 Trefferlage: 0.17 mm links, 0.34 mm tief
 Streuwert: 1.47, horizontal: 1.67, vertikal: 1.24



Ergebnis: 400.1 (379)
Serien: 102.7 98.4 100.3 98.7
Zähler: 24 12 3 1 0 0 0 0 0 0
Innenzehner: 24
Weiteste: 778 (34.), 571 (19.), 569 (17.)
beste Teiler: 26.4 (2.), 43.8 (10.), 47.2 (37.)
Trefferlage: 1.14 mm links, 0.14 mm tief
Streuwert: 1.90, horizontal: 2.45, vertikal: 1.11

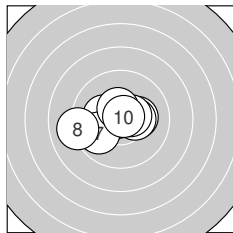
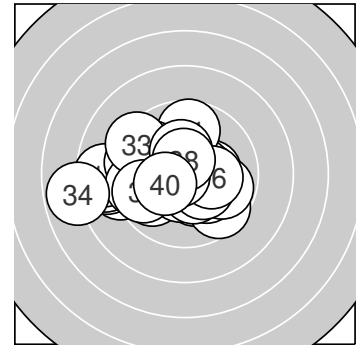

Serie 1: 102.7 (98)

10.2* →	10.8* ↖	10.3* →	10.4* ←	10.5* →
10.2* ←	9.9 ↗	9.1 ←	10.5* ↑	10.8* ↘

beste Teiler: 26.4 (2.), 43.8 (10.), 115.4 (5.)
Trefferlage: 0.57 mm links, 0.00 mm
Streuwert: 1.49, horizontal: 1.98, vertikal: 0.75

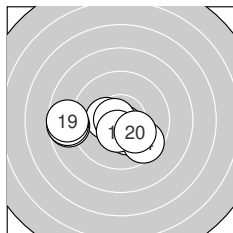

Serie 2: 98.4 (93)

10.3* ↓	10.3* ←	10.7* ↓	9.6 ↓	8.7 ←
10.7* ←	8.7 ←	10.5* ↓	8.7 ←	10.2* ↘

beste Teiler: 66.4 (16.), 70.2 (13.), 123.0 (18.)
Trefferlage: 1.45 mm links, 0.78 mm tief
Streuwert: 2.26, horizontal: 3.10, vertikal: 0.79

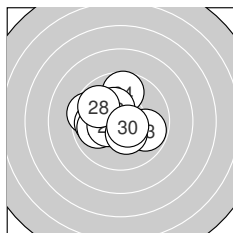

Serie 3: 100.3 (94)

9.5 ←	9.9 ←	9.8 →	9.7 ↑	9.9 ←
10.3* ↖	10.4* ←	9.8 ↖	10.4* ↓	10.6* ↘

beste Teiler: 92.6 (30.), 143.6 (29.), 144.2 (27.)
Trefferlage: 0.88 mm links, 0.27 mm hoch
Streuwert: 1.69, horizontal: 1.94, vertikal: 1.39

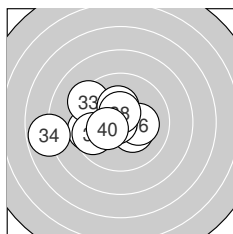

Serie 4: 98.7 (94)

9.5 ←	10.3* ↘	9.3 ↖	7.8 ←	10.3* ↑
10.2* →	10.8* ←	10.5* ↑	9.7 ←	10.3* ↗

beste Teiler: 47.2 (37.), 102.3 (38.), 157.8 (40.)
Trefferlage: 1.65 mm links, 0.06 mm tief
Streuwert: 2.18, horizontal: 2.81, vertikal: 1.25



Ergebnis: 395.1 (379)
Serien: 97.4 98.2 99.3 100.2
Zähler: 20 19 1 0 0 0 0 0 0 0
Innenzehner: 15
Weiteste: 626 (27.), 500 (35.), 477 (11.)
beste Teiler: 50.7 (19.), 59.6 (34.), 79.9 (1.)
Trefferlage: 0.30 mm rechts, 0.10 mm tief
Streuwert: 2.14, horizontal: 2.31, vertikal: 1.97

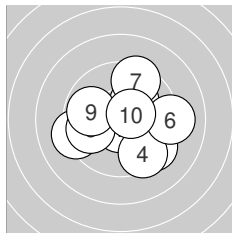
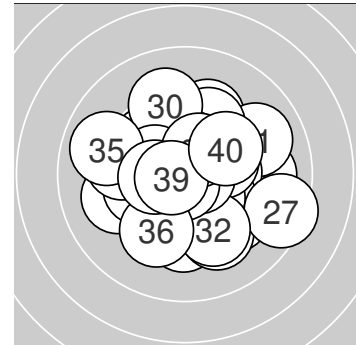

Serie 1: 97.4 (93)

10.6* ↓	9.4 ↘	10.1 ↗	9.5 ↘	9.2 ←
9.1 →	9.4 ↑	9.8 ←	9.8 ←	10.5* ↗

beste Teiler: 79.9 (1.), 106.4 (10.), 205.2 (3.)
Trefferlage: 0.35 mm rechts, 0.22 mm tief
Streuwert: 2.38, horizontal: 2.75, vertikal: 1.95

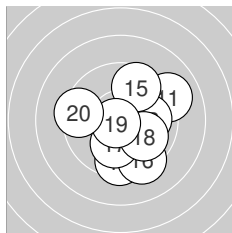

Serie 2: 98.2 (94)

9.0 ↗	9.5 ↓	10.0 →	10.6* ↓	9.6 ↑
9.3 ↘	10.1 ↓	9.9 ↘	10.8* ↖	9.4 ←

beste Teiler: 50.7 (19.), 84.5 (14.), 217.5 (17.)
Trefferlage: 0.76 mm rechts, 0.60 mm tief
Streuwert: 2.21, horizontal: 2.21, vertikal: 2.22

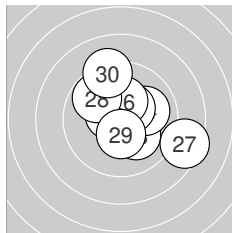

Serie 3: 99.3 (96)

10.5* ↖	10.2* ↑	10.1 ↘	10.0 →	10.4* ↗
10.3* ↑	8.4 ↘	9.8 ↘	10.4* ↓	9.2 ↑

beste Teiler: 106.4 (21.), 135.2 (25.), 136.0 (29.)
Trefferlage: 0.61 mm rechts, 0.66 mm hoch
Streuwert: 2.09, horizontal: 2.25, vertikal: 1.93

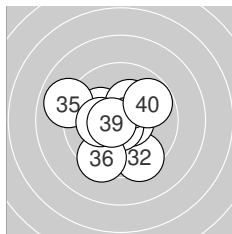

Serie 4: 100.2 (96)

10.2* ↖	9.4 ↘	10.6* →	10.7* ↓	9.0 ←
9.4 ↙	10.3* ↗	10.2* ←	10.6* ←	9.8 ↗

beste Teiler: 59.6 (34.), 82.7 (33.), 84.8 (39.)
Trefferlage: 0.52 mm links, 0.25 mm tief
Streuwert: 1.98, horizontal: 2.13, vertikal: 1.83



Ergebnis: **397.2** (380)
 Serien: 97.6 99.4 99.5 100.7
 Zähler: 23 14 3 0 0 0 0 0 0 0
 Innenzehner: 16
 Weitester: 612 (9.), 583 (17.), 522 (8.)
 beste Teiler: 52.4 (12.), 72.8 (22.), 90.1 (18.)
 Trefferlage: 0.68 mm links, 0.25 mm hoch
 Streuwert: 1.97, horizontal: 2.26, vertikal: 1.64

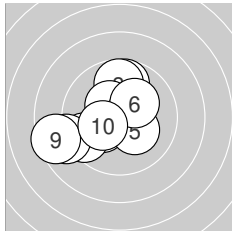
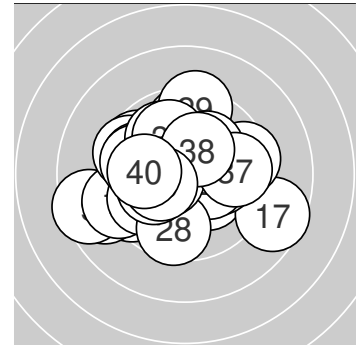

Serie 1: 97.6 (93)

10.2* ↙	9.7 ↑	9.7 ↑	10.4* ↘	10.2* ↘
10.2* ↗	9.5 ↙	8.9 ↙	8.5 ↙	10.3* ↙

beste Teiler: 140.4 (4.), 170.3 (10.), 179.6 (5.)
 Trefferlage: 1.47 mm links, 0.02 mm tief
 Streuwert: 2.24, horizontal: 2.48, vertikal: 1.98

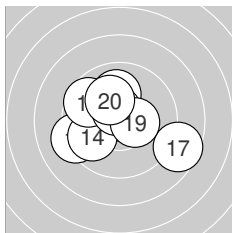

Serie 2: 99.4 (95)

9.2 ↙	10.7* ↘	10.4* ↙	9.8 ↙	10.0 ↑
9.6 ↘	8.6 ↘	10.6* ↑	10.4* →	10.1 ↘

beste Teiler: 52.4 (12.), 90.1 (18.), 140.5 (19.)
 Trefferlage: 0.58 mm links, 0.16 mm hoch
 Streuwert: 2.14, horizontal: 2.58, vertikal: 1.60

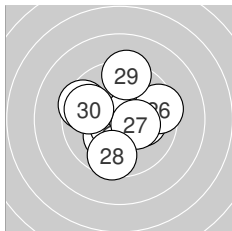

Serie 3: 99.5 (95)

10.2* ↙	10.7* ↙	9.5 ↘	10.1 →	10.5* ↗
9.5 →	10.3* ↘	9.6 ↓	9.3 ↑	9.8 ↙

beste Teiler: 72.8 (22.), 122.6 (25.), 153.6 (27.)
 Trefferlage: 0.03 mm rechts, 0.17 mm hoch
 Streuwert: 2.03, horizontal: 2.14, vertikal: 1.92

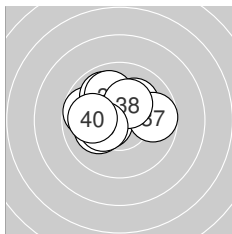

Serie 4: 100.7 (97)

9.8 ↙	10.1 ↙	10.1 ↗	9.9 ↘	10.5* ↙
10.0 ↘	9.7 →	10.3* ↗	10.3* ↙	10.0 ↙

beste Teiler: 111.4 (35.), 159.8 (39.), 166.8 (38.)
 Trefferlage: 0.70 mm links, 0.70 mm hoch
 Streuwert: 1.53, horizontal: 1.85, vertikal: 1.12



Ergebnis: 352.8 (335)
Serien: 90.8 85.7 86.4 89.9
Zähler: 4 17 10 8 1 0 0 0 0 0 0
Innenzehner: 2
Weiteste: 1080 (3.), 959 (27.), 884 (23.)
beste Teiler: 165.3 (40.), 191.6 (37.), 214.2 (10.)
Trefferlage: 0.96 mm rechts, 0.79 mm tief
Streuwert: 4.06, horizontal: 5.00, vertikal: 2.84

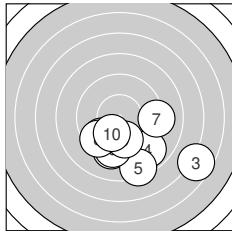
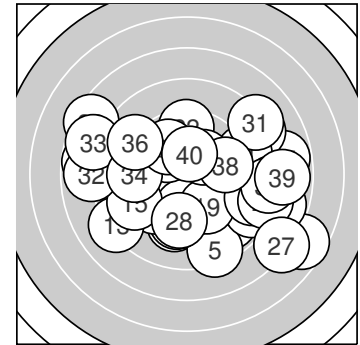

Serie 1: 90.8 (86)

9.3 ↙	9.7 ↗	6.6 ↘	8.9 ↘	8.3 ↘
9.4 ↙	9.2 →	9.5 ↗	9.8 ↘	10.1 ↗

beste Teiler: 214.2 (10.), 278.0 (9.), 323.9 (2.)
Trefferlage: 1.24 mm rechts, 3.31 mm tief
Streuwert: 2.89, horizontal: 3.70, vertikal: 1.74

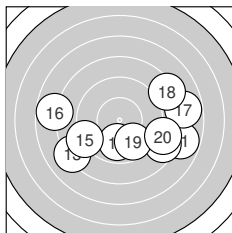

Serie 2: 85.7 (80)

7.8 ↘	9.9 ↓	8.1 ↗	8.6 ↘	9.0 ↗
7.8 ←	7.8 →	8.3 ↗	9.7 ↘	8.7 ↘

beste Teiler: 267.6 (12.), 306.3 (19.), 482.7 (15.)
Trefferlage: 1.48 mm rechts, 1.31 mm tief
Streuwert: 4.41, horizontal: 5.76, vertikal: 2.39

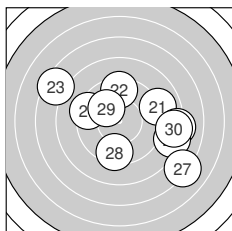

Serie 3: 86.4 (84)

9.0 →	9.4 ↑	7.4 ↘	9.3 ←	8.1 →
8.3 ↘	7.1 ↘	9.4 ↓	10.1 ↘	8.3 →

beste Teiler: 225.5 (29.), 381.0 (22.), 381.0 (28.)
Trefferlage: 1.84 mm rechts, 0.06 mm tief
Streuwert: 4.42, horizontal: 5.36, vertikal: 3.21

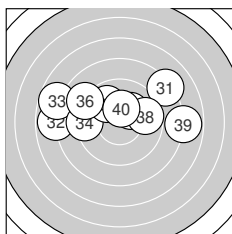

Serie 4: 89.9 (85)

8.2 ↗	7.8 ←	7.7 ↘	9.2 ←	9.9 ↘
9.0 ↘	10.2* ↗	9.7 →	7.9 →	10.3* ↑

beste Teiler: 165.3 (40.), 191.6 (37.), 268.7 (35.)
Trefferlage: 0.73 mm links, 1.50 mm hoch
Streuwert: 3.89, horizontal: 5.31, vertikal: 1.43



Ergebnis: **380.3** (363)
 Serien: 98.8 96.8 95.3 89.4
 Zähler: 15 15 9 0 1 0 0 0 0 0 0
 Innenzehner: 11
 Weitester: 1014 (40.), 700 (22.), 684 (38.)
 beste Teiler: 7.2 (33.), 75.5 (32.), 82.2 (30.)
 Trefferlage: 1.53 mm links, 0.68 mm tief
 Streuwert: 2.78, horizontal: 2.72, vertikal: 2.84

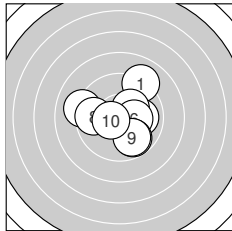
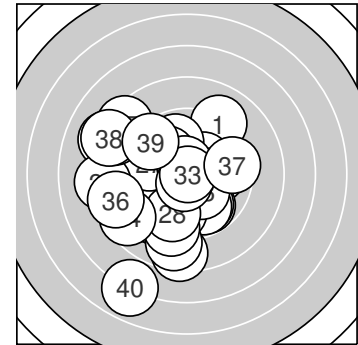

Serie 1: 98.8 (95)

9.0 ↗	10.3* ↘	10.0 →	9.1 ←	10.3* ↗
10.3* →	9.8 ↘	9.7 ←	9.8 ↘	10.5* ←

beste Teiler: 110.0 (10.), 154.8 (2.), 170.9 (5.)
 Trefferlage: 0.39 mm rechts, 0.03 mm hoch
 Streuwert: 2.16, horizontal: 2.42, vertikal: 1.86

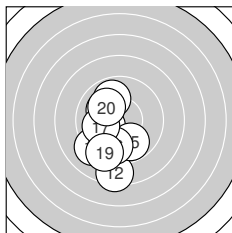

Serie 2: 96.8 (93)

10.1 ↘	8.4 ↓	9.2 ↗	10.3* ←	9.8 ↘
9.7 ↓	10.0 ←	9.9 ↗	9.3 ↘	10.1 ↘

beste Teiler: 169.7 (14.), 214.4 (11.), 221.3 (20.)
 Trefferlage: 1.29 mm links, 1.49 mm tief
 Streuwert: 2.14, horizontal: 1.20, vertikal: 2.78

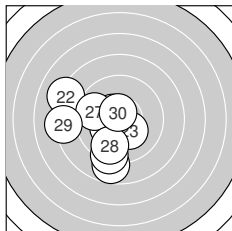

Serie 3: 95.3 (91)

10.3* ←	8.2 ↘	10.2* ↘	10.5* ↘	8.7 ↓
9.2 ↓	9.7 ←	9.6 ↓	8.3 ←	10.6* ↑

beste Teiler: 82.2 (30.), 112.6 (24.), 167.0 (21.)
 Trefferlage: 2.08 mm links, 1.06 mm tief
 Streuwert: 2.58, horizontal: 2.59, vertikal: 2.57

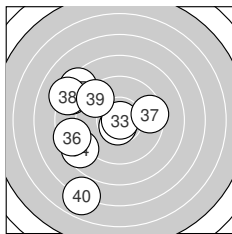

Serie 4: 89.4 (84)

8.3 ↘	10.7* ↓	10.9* →	8.6 ←	8.4 ↘
8.5 ←	9.5 →	8.2 ↘	9.4 ↘	6.9 ↓

beste Teiler: 7.2 (33.), 75.5 (32.), 369.0 (37.)
 Trefferlage: 3.14 mm links, 0.21 mm tief
 Streuwert: 3.61, horizontal: 3.26, vertikal: 3.92



Ergebnis: 379.2 (362)
Serien: 91.8 96.9 96.4 94.1
Zähler: 14 14 12 0 0 0 0 0 0 0 0
Innenzehner: 9
Weiteste: 742 (6.), 703 (2.), 670 (33.)
beste Teiler: 21.5 (11.), 47.5 (23.), 59.6 (32.)
Trefferlage: 0.37 mm links, 0.27 mm tief
Streuwert: 2.96, horizontal: 3.30, vertikal: 2.59

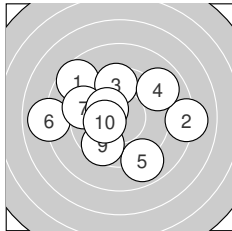
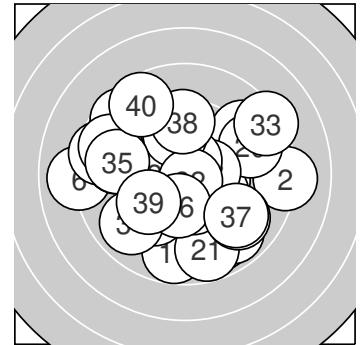

Serie 1: 91.8 (88)

8.6 ↘	8.1 →	9.6 ↑	9.0 ↗	8.9 ↘
8.0 ←	9.4 ↖	10.3* ↘	9.6 ↙	10.3* ←

beste Teiler: 157.5 (8.), 163.6 (10.), 334.6 (9.)
Trefferlage: 0.72 mm links, 0.36 mm hoch
Streuwert: 3.55, horizontal: 4.25, vertikal: 2.67

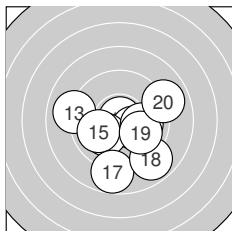

Serie 2: 96.9 (93)

10.9* ↑	10.3* ↘	9.0 ←	10.1 ↙	10.0 ↖
10.0 →	8.8 ↓	8.9 ↘	9.9 ↘	9.0 →

beste Teiler: 21.5 (11.), 158.5 (12.), 212.1 (14.)
Trefferlage: 0.46 mm rechts, 1.15 mm tief
Streuwert: 2.53, horizontal: 2.84, vertikal: 2.19

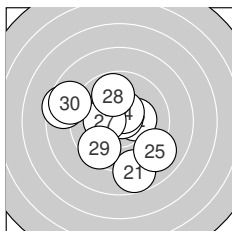

Serie 3: 96.4 (91)

8.8 ↓	10.3* →	10.8* ↗	10.6* ↑	9.0 ↘
8.5 ←	10.3* ←	9.8 ↑	9.6 ↙	8.7 ↖

beste Teiler: 47.5 (23.), 100.9 (24.), 158.1 (27.)
Trefferlage: 0.80 mm links, 0.32 mm tief
Streuwert: 2.79, horizontal: 3.02, vertikal: 2.54

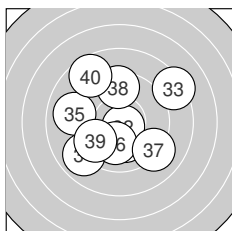

Serie 4: 94.1 (90)

10.1 ↓	10.7* ↘	8.3 ↗	8.9 ↙	9.0 ←
10.1 ↓	9.1 ↘	9.5 ↑	9.7 ↙	8.7 ↖

beste Teiler: 59.6 (32.), 208.1 (31.), 225.3 (36.)
Trefferlage: 0.44 mm links, 0.00 mm
Streuwert: 3.16, horizontal: 3.27, vertikal: 3.04



Ergebnis: **396.1** (377)
 Serien: 99.0 103.2 98.9 95.0
 Zähler: 20 17 3 0 0 0 0 0 0 0
 Innenzehner: 16
 Weitester: 719 (39.), 595 (21.), 521 (25.)
 beste Teiler: 34.1 (26.), 54.5 (16.), 65.7 (18.)
 Trefferlage: 1.18 mm links, 0.04 mm tief
 Streuwert: 2.01, horizontal: 2.33, vertikal: 1.64

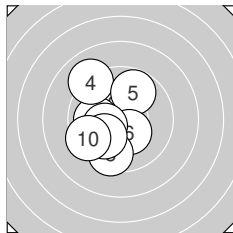
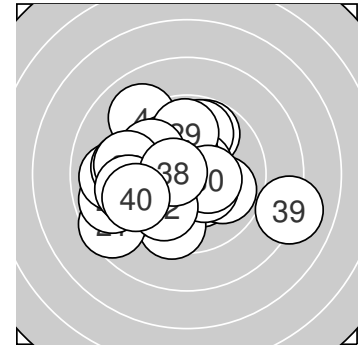

Serie 1: 99.0 (96)

10.4* ↘	10.2* ↖	10.0 ←	9.0 ↖	9.8 ↗
10.3* ↘	10.3* ↙	9.5 ↓	10.0 ↗	9.5 ↙

beste Teiler: 126.4 (1.), 153.6 (6.), 169.9 (7.)
 Trefferlage: 1.18 mm links, 0.21 mm tief
 Streuwert: 1.90, horizontal: 1.50, vertikal: 2.23

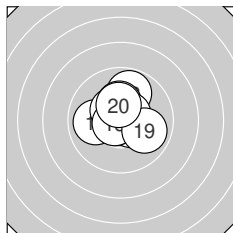

Serie 2: 103.2 (98)

10.0 ←	9.8 ↗	10.3* ↑	10.5* ↘	10.6* ↗
10.7* ↙	10.4* ↖	10.7* ↙	9.9 ↘	10.3* ↑

beste Teiler: 54.5 (16.), 65.7 (18.), 96.0 (15.)
 Trefferlage: 0.03 mm rechts, 0.51 mm hoch
 Streuwert: 1.24, horizontal: 1.31, vertikal: 1.17

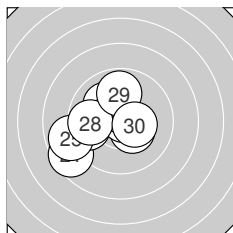

Serie 3: 98.9 (93)

8.6 ↙	9.6 ←	10.4* ↘	10.1 ↖	8.9 ↙
10.8* ↗	10.5* ↑	9.7 ←	9.9 ↑	10.4* ↘

beste Teiler: 34.1 (26.), 118.6 (27.), 144.0 (30.)
 Trefferlage: 1.52 mm links, 0.14 mm tief
 Streuwert: 2.08, horizontal: 2.39, vertikal: 1.72

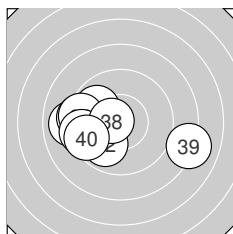

Serie 4: 95.0 (90)

9.9 ↖	9.9 ↙	9.0 ←	9.9 ↖	9.3 ↙
9.4 ←	9.4 ←	10.6* ←	8.1 ↘	9.5 ↙

beste Teiler: 90.9 (38.), 258.5 (31.), 264.9 (32.)
 Trefferlage: 2.05 mm links, 0.35 mm tief
 Streuwert: 2.56, horizontal: 3.35, vertikal: 1.35



Ergebnis: **395.5** (381)
 Serien: 98.9 95.7 102.7 98.2
 Zähler: 23 16 0 1 0 0 0 0 0 0
 Innenzehner: 18
 Weitestе: 781 (17.), 495 (13.), 494 (10.)
 beste Teiler: 71.1 (26.), 84.9 (29.), 99.4 (18.)
 Trefferlage: 0.93 mm rechts, 0.25 mm tief
 Streuwert: 2.08, horizontal: 2.46, vertikal: 1.61

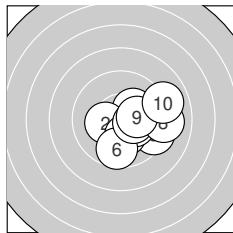
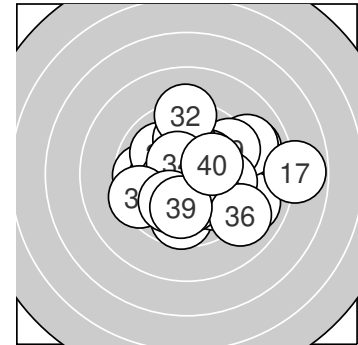

Serie 1: 98.9 (96)

10.3* ↗	10.3* ←	9.4 →	10.2* ↓	10.3* ↘
9.7 ↓	10.4* ↘	9.1 →	10.2* →	9.0 →

beste Teiler: 143.1 (7.), 167.2 (5.), 169.5 (2.)
 Trefferlage: 1.73 mm rechts, 0.51 mm tief
 Streuwert: 1.78, horizontal: 2.06, vertikal: 1.44

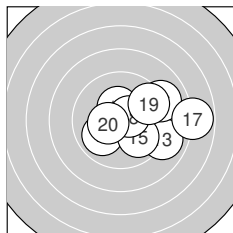

Serie 2: 95.7 (91)

9.9 ↙	9.2 →	9.0 ↘	10.4* ↑	9.9 ↘
9.0 →	7.8 →	10.6* →	9.5 →	10.4* ←

beste Teiler: 99.4 (18.), 138.9 (20.), 145.3 (14.)
 Trefferlage: 2.33 mm rechts, 0.10 mm hoch
 Streuwert: 2.42, horizontal: 3.07, vertikal: 1.51

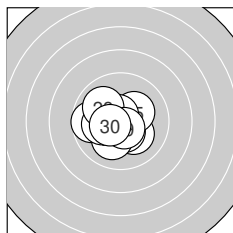

Serie 3: 102.7 (99)

9.7 ←	10.2* ↘	10.5* ↓	10.1 ↙	10.3* ↗
10.7* ↖	10.1 ←	10.0 ↘	10.6* ↓	10.5* ←

beste Teiler: 71.1 (26.), 84.9 (29.), 121.8 (23.)
 Trefferlage: 0.57 mm links, 0.29 mm tief
 Streuwert: 1.32, horizontal: 1.52, vertikal: 1.08

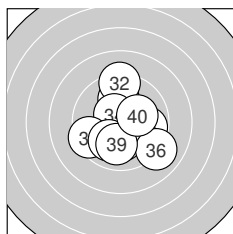

Serie 4: 98.2 (95)

9.9 ↑	9.2 ↑	10.2* ↓	10.5* ↖	9.8 →
9.0 ↘	9.4 ↙	10.0 ↙	10.0 ↓	10.2* →

beste Teiler: 108.0 (34.), 194.7 (40.), 199.0 (33.)
 Trefferlage: 0.25 mm rechts, 0.31 mm tief
 Streuwert: 2.23, horizontal: 2.10, vertikal: 2.36



Ergebnis: **405.2** (387)
 Serien: 100.8 100.0 102.7 101.7
 Zähler: 29 9 2 0 0 0 0 0 0 0
 Innenzehner: 23
 Weitester: 555 (19.), 510 (7.), 462 (26.)
 beste Teiler: 12.7 (15.), 45.1 (33.), 49.0 (22.)
 Trefferlage: 0.01 mm rechts, 0.11 mm tief
 Streuwert: 1.73, horizontal: 1.72, vertikal: 1.74

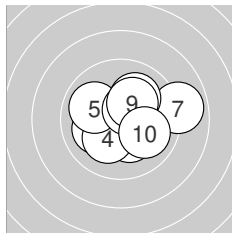
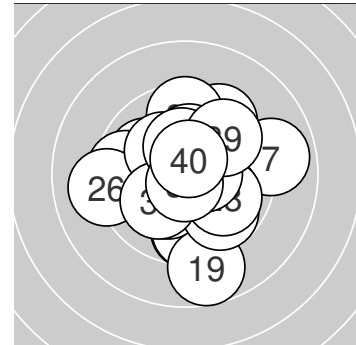

Serie 1: 100.8 (98)

10.4* ↖	10.1 ↖	10.3* ↘	10.2* ↗	10.0 ↖
10.5* ↗	8.9 →	10.1 ↗	10.3* ↗	10.0 ↘

beste Teiler: 105.6 (6.), 149.0 (1.), 171.7 (3.)
 Trefferlage: 0.40 mm rechts, 0.14 mm hoch
 Streuwert: 1.81, horizontal: 2.21, vertikal: 1.29

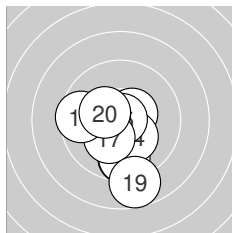

Serie 2: 100.0 (95)

9.6 ↓	10.5* ↗	9.6 ↓	10.2* ↘	10.9* ↗
10.4* ↖	10.2* ↗	9.6 ←	8.7 ↓	10.3* ↖

beste Teiler: 12.7 (15.), 114.1 (12.), 146.4 (16.)
 Trefferlage: 0.32 mm links, 1.28 mm tief
 Streuwert: 1.81, horizontal: 1.47, vertikal: 2.10

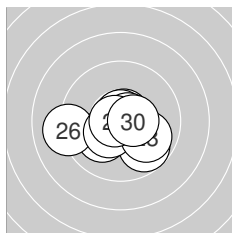

Serie 3: 102.7 (97)

10.7* ↗	10.8* ↑	10.7* →	9.8 ↘	10.1 ↗
9.1 ←	10.4* ↗	9.9 ↘	10.7* ←	10.5* →

beste Teiler: 49.0 (22.), 51.0 (29.), 62.6 (21.)
 Trefferlage: 0.13 mm links, 0.52 mm tief
 Streuwert: 1.54, horizontal: 1.98, vertikal: 0.92

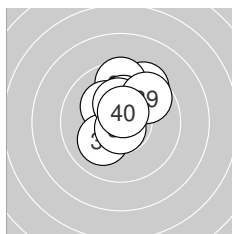

Serie 4: 101.7 (97)

9.5 ↗	9.6 ↑	10.8* ←	10.2* ↑	10.2* ↖
10.1 ↗	10.3* ↑	10.7* ↓	9.7 ↗	10.6* ↑

beste Teiler: 45.1 (33.), 52.0 (38.), 91.6 (40.)
 Trefferlage: 0.12 mm rechts, 1.21 mm hoch
 Streuwert: 1.39, horizontal: 1.21, vertikal: 1.55



Ergebnis: **400.3** (382)
 Serien: 98.3 99.3 100.8 101.9
 Zähler: 23 16 1 0 0 0 0 0 0 0
 Innenzehner: 20
 Weitester: 565 (19.), 498 (24.), 488 (11.)
 beste Teiler: 23.1 (28.), 43.8 (30.), 46.0 (5.)
 Trefferlage: 0.31 mm rechts, 0.15 mm tief
 Streuwert: 1.97, horizontal: 2.20, vertikal: 1.71

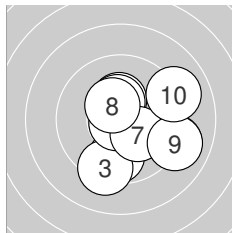
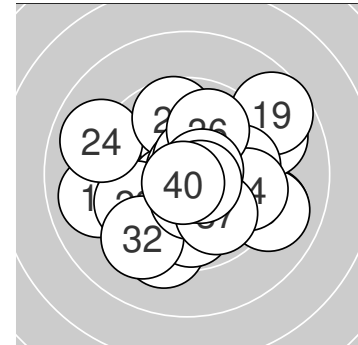

Serie 1: 98.3 (95)

10.3* ↑ 9.8 ↓ 9.3 ↓
 9.1 ↘ 10.2* ↘ 10.4* ↘
 beste Teiler: 46.0 (5.), 131.3 (8.), 141.4 (4.)
 Trefferlage: 1.15 mm rechts, 0.61 mm tief
 Streuwert: 2.20, horizontal: 2.31, vertikal: 2.09

10.4* ↑ 10.8* ↙
 9.0 ↘ 9.0 ↘

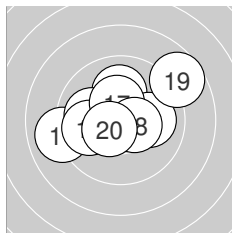

Serie 2: 99.3 (96)

9.0 ← 10.3* ← 10.0 ↑
 10.0 → 10.4* ↑ 10.5* →
 beste Teiler: 116.0 (20.), 119.5 (18.), 144.1 (17.)
 Trefferlage: 0.45 mm links, 0.45 mm hoch
 Streuwert: 2.14, horizontal: 2.66, vertikal: 1.43

10.0 ← 9.9 ←
 8.7 ↗ 10.5* ↙

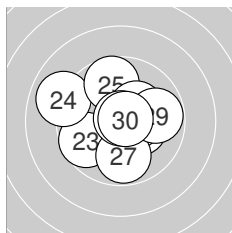

Serie 3: 100.8 (95)

10.3* ↘ 10.5* → 9.7 ←
 10.3* ↗ 9.8 ↓ 10.9* ↑
 beste Teiler: 23.1 (28.), 43.8 (30.), 121.0 (22.)
 Trefferlage: 0.06 mm links, 0.18 mm hoch
 Streuwert: 1.94, horizontal: 2.20, vertikal: 1.63

9.0 ↖ 9.7 ↑
 9.8 → 10.8* ↗

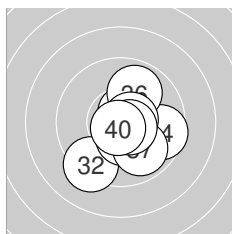

Serie 4: 101.9 (96)

10.3* ↘ 9.3 ↙ 10.6* ↗
 9.9 ↑ 9.9 ↘ 10.6* →
 beste Teiler: 51.4 (40.), 83.3 (39.), 84.4 (38.)
 Trefferlage: 0.63 mm rechts, 0.65 mm tief
 Streuwert: 1.51, horizontal: 1.43, vertikal: 1.59

9.6 → 10.4* ↓
 10.6* ↘ 10.7* ↙



Ergebnis: **402.7** (382)
 Serien: 101.9 101.0 101.5 98.3
 Zähler: 22 18 0 0 0 0 0 0 0 0
 Innenzehner: 19
 Weitester: 481 (28.), 387 (34.), 373 (30.)
 beste Teiler: 8.0 (16.), 30.0 (25.), 31.1 (1.)
 Trefferlage: 0.10 mm links, 0.05 mm hoch
 Streuwert: 1.78, horizontal: 2.19, vertikal: 1.26

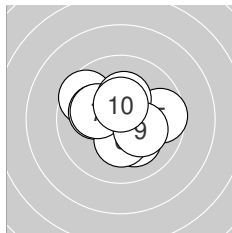
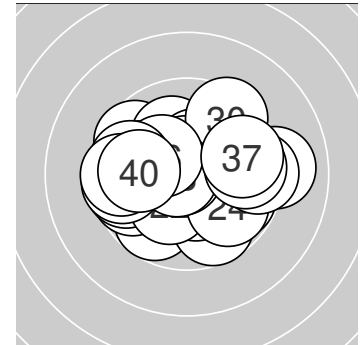

Serie 1: 101.9 (98)

10.8* ↓	9.6 ↖	10.1 ←	10.2* ↓	9.7 →
10.3* ↓	10.2* ↖	10.3* ↑	10.2* ↗	10.5* ↑

beste Teiler: 31.1 (1.), 120.0 (10.), 167.1 (6.)
 Trefferlage: 0.04 mm links, 0.17 mm hoch
 Streuwert: 1.57, horizontal: 1.83, vertikal: 1.26

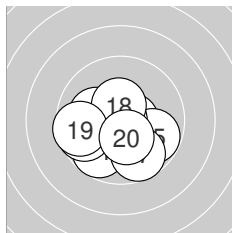

Serie 2: 101.0 (95)

9.7 ↙	10.1 ←	10.6* →	9.7 ←	9.8 ↘
10.9* ↖	9.7 ↘	10.5* ↑	9.6 ←	10.4* ↓

beste Teiler: 8.0 (16.), 87.0 (13.), 122.9 (18.)
 Trefferlage: 0.48 mm links, 0.80 mm tief
 Streuwert: 1.64, horizontal: 1.96, vertikal: 1.26

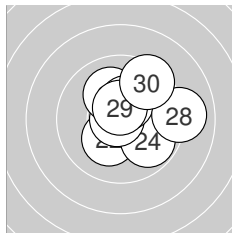

Serie 3: 101.5 (97)

10.7* ↘	10.2* ↙	10.4* ↑	9.8 ↘	10.8* ←
10.1 ↖	10.4* ↑	9.0 →	10.6* ↑	9.5 ↗

beste Teiler: 30.0 (25.), 74.0 (21.), 94.1 (29.)
 Trefferlage: 0.83 mm rechts, 0.51 mm hoch
 Streuwert: 1.65, horizontal: 1.76, vertikal: 1.52

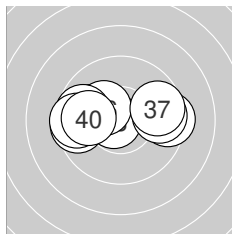

Serie 4: 98.3 (92)

9.9 ←	9.5 ←	10.7* ←	9.4 →	9.7 →
10.3* ↖	9.7 →	9.7 ←	9.5 ←	9.9 ←

beste Teiler: 55.5 (33.), 169.0 (36.), 262.5 (40.)
 Trefferlage: 0.72 mm links, 0.33 mm hoch
 Streuwert: 2.13, horizontal: 2.97, vertikal: 0.48



Ergebnis: **394.5** (374)
 Serien: 96.4 100.4 100.9 96.8
 Zähler: 19 16 5 0 0 0 0 0 0 0
 Innenzehner: 15
 Weitester: 655 (9.), 619 (1.), 581 (40.)
 beste Teiler: 28.3 (29.), 33.2 (13.), 63.7 (24.)
 Trefferlage: 0.11 mm links, 0.09 mm tief
 Streuwert: 2.25, horizontal: 2.61, vertikal: 1.83

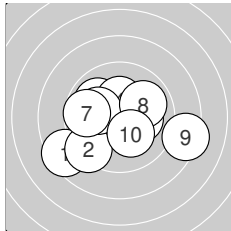
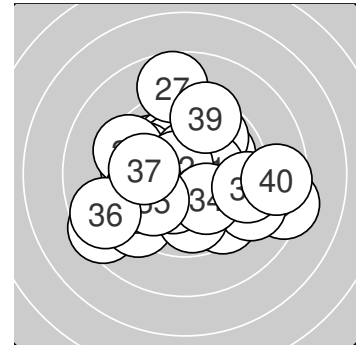

Serie 1: 96.4 (92)

8.5 ↙	9.3 ↙	9.9 ↘	10.3* ↑	10.2* →
10.1 ←	9.7 ←	9.9 →	8.3 →	10.2* ↘

beste Teiler: 164.0 (4.), 186.9 (10.), 191.6 (5.)
 Trefferlage: 0.38 mm links, 0.46 mm tief
 Streuwert: 2.72, horizontal: 3.36, vertikal: 1.87

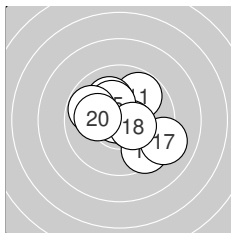

Serie 2: 100.4 (96)

9.8 ↗	10.5* →	10.8* ←	10.1 ↘	10.3* ↘
9.5 ↘	9.1 →	10.4* →	9.8 ←	10.1 ←

beste Teiler: 33.2 (13.), 101.8 (12.), 136.5 (18.)
 Trefferlage: 0.38 mm rechts, 0.14 mm hoch
 Streuwert: 1.89, horizontal: 2.12, vertikal: 1.64

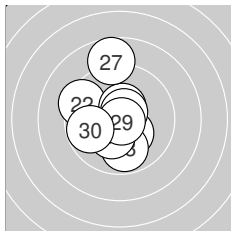

Serie 3: 100.9 (95)

10.3* ↘	9.4 ↖	9.8 ↓	10.7* ↙	10.5* ↑
10.6* ↗	8.7 ↑	10.3* ↙	10.8* ↘	9.8 ←

beste Teiler: 28.3 (29.), 63.7 (24.), 77.3 (26.)
 Trefferlage: 0.59 mm links, 0.16 mm hoch
 Streuwert: 1.93, horizontal: 1.48, vertikal: 2.28

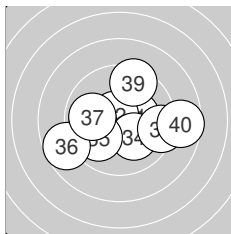

Serie 4: 96.8 (91)

10.3* →	10.7* ↘	9.9 ←	10.1 ↘	9.9 ↙
8.7 ↙	9.9 ←	9.3 →	9.4 ↑	8.6 →

beste Teiler: 67.2 (32.), 157.2 (31.), 206.9 (34.)
 Trefferlage: 0.13 mm rechts, 0.21 mm tief
 Streuwert: 2.61, horizontal: 3.29, vertikal: 1.67



Ergebnis: 391.8 (373)
Serien: 95.8 96.6 96.3 103.1
Zähler: 21 12 6 1 0 0 0 0 0 0 0
Innenzehner: 19
Weiteste: 763 (29.), 678 (8.), 607 (3.)
beste Teiler: 30.2 (31.), 52.3 (28.), 68.2 (2.)
Trefferlage: 0.74 mm rechts, 0.77 mm hoch
Streuwert: 2.38, horizontal: 2.91, vertikal: 1.67

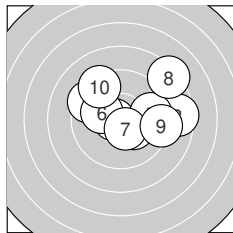
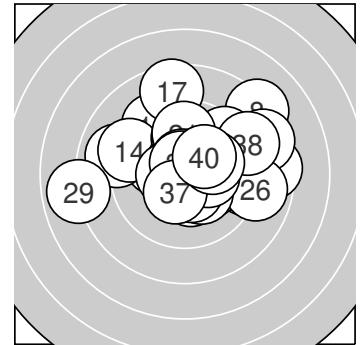

Serie 1: 95.8 (92)

10.3* ↘	10.7* ←	8.5 →	9.4 ↖	9.6 →
10.1 ↖	10.5* ↘	8.2 ↗	9.2 →	9.3 ↗

beste Teiler: 68.2 (2.), 114.0 (7.), 167.6 (1.)
Trefferlage: 1.22 mm rechts, 0.87 mm hoch
Streuwert: 2.70, horizontal: 3.33, vertikal: 1.86

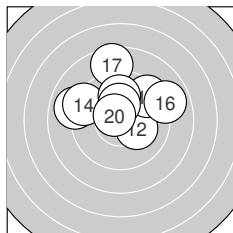

Serie 2: 96.6 (92)

9.0 ↖	10.2* ↘	10.4* ↑	9.3 ↖	9.4 ↗
8.9 ↗	8.6 ↑	9.9 ↑	10.3* ↑	10.6* ↖

beste Teiler: 85.2 (20.), 150.3 (13.), 167.7 (19.)
Trefferlage: 0.17 mm links, 1.87 mm hoch
Streuwert: 2.36, horizontal: 2.85, vertikal: 1.73

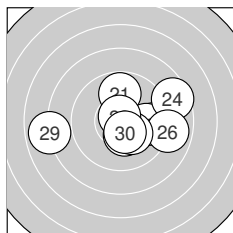

Serie 3: 96.3 (90)

9.8 ↑	9.5 →	9.9 →	8.6 ↗	10.3* ↓
8.9 →	10.3* ↘	10.7* ↑	7.9 ←	10.4* ↓

beste Teiler: 52.3 (28.), 126.0 (30.), 151.6 (25.)
Trefferlage: 1.11 mm rechts, 0.10 mm tief
Streuwert: 2.83, horizontal: 3.68, vertikal: 1.57

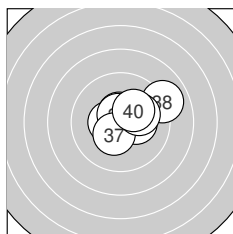

Serie 4: 103.1 (99)

10.8* ↘	10.6* ↑	10.6* →	10.3* →	10.5* ←
10.6* ↑	10.4* ↘	9.0 ↗	10.1 →	10.2* ↗

beste Teiler: 30.2 (31.), 84.1 (36.), 94.4 (33.)
Trefferlage: 0.81 mm rechts, 0.44 mm hoch
Streuwert: 1.35, horizontal: 1.65, vertikal: 0.95



Ergebnis: **398.9** (381)
 Serien: 99.1 99.3 100.5 100.0
 Zähler: 23 15 2 0 0 0 0 0 0 0
 Innenzehner: 21
 Weitester: 638 (38.), 530 (1.), 500 (4.)
 beste Teiler: 35.1 (10.), 53.0 (31.), 65.1 (32.)
 Trefferlage: 0.59 mm links, 0.04 mm hoch
 Streuwert: 1.98, horizontal: 2.62, vertikal: 0.97

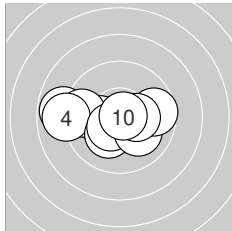
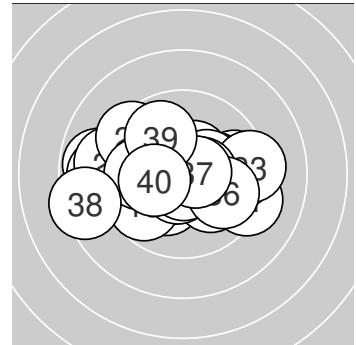

Serie 1: 99.1 (95)

8.8 ←	10.2* ←	9.5 ←	9.0 ←	10.2* ↙
10.5* ↘	10.1 ↘	9.7 →	10.3* →	10.8* →

beste Teiler: 35.1 (10.), 122.4 (6.), 157.0 (9.)
 Trefferlage: 1.06 mm links, 0.25 mm tief
 Streuwert: 2.11, horizontal: 2.88, vertikal: 0.78

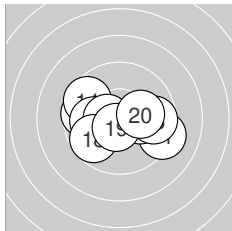

Serie 2: 99.3 (95)

9.2 ↘	10.2* →	9.6 ←	9.6 ↘	9.7 →
10.0 ←	10.5* ←	9.7 ↙	10.6* ↙	10.2* →

beste Teiler: 91.7 (19.), 117.0 (17.), 192.6 (12.)
 Trefferlage: 0.15 mm links, 0.24 mm tief
 Streuwert: 2.05, horizontal: 2.71, vertikal: 1.03

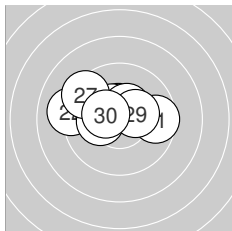

Serie 3: 100.5 (97)

9.6 →	9.1 ←	10.5* ↑	10.2* ←	10.2* ←
10.4* ↘	9.4 ↘	10.4* ↗	10.3* →	10.4* ↘

beste Teiler: 110.6 (23.), 127.3 (26.), 128.7 (28.)
 Trefferlage: 0.80 mm links, 0.74 mm hoch
 Streuwert: 1.70, horizontal: 2.29, vertikal: 0.71

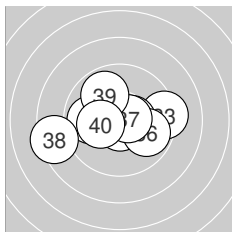

Serie 4: 100.0 (94)

10.7* ↘	10.7* ↓	9.3 →	9.9 ←	10.5* →
9.8 ↘	10.6* →	8.4 ←	9.9 ↘	10.2* ←

beste Teiler: 53.0 (31.), 65.1 (32.), 80.0 (37.)
 Trefferlage: 0.37 mm links, 0.06 mm tief
 Streuwert: 2.17, horizontal: 2.87, vertikal: 1.10



Ergebnis: **390.5** (371)
 Serien: 98.1 95.2 97.6 99.6
 Zähler: 17 17 6 0 0 0 0 0 0 0
 Innenzehner: 15
 Weitester: 688 (21.), 573 (16.), 536 (37.)
 beste Teiler: 27.0 (35.), 39.8 (38.), 98.1 (23.)
 Trefferlage: 0.39 mm rechts, 0.24 mm hoch
 Streuwert: 2.42, horizontal: 2.86, vertikal: 1.89

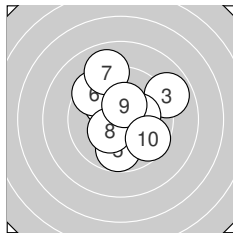
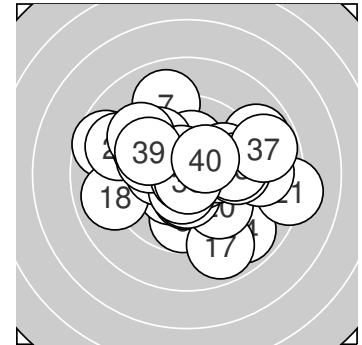

Serie 1: 98.1 (94)

10.3* ↖ 10.1 ↖ 8.9 ↗ 10.2* → 9.8 ↓
 9.5 ↖ 9.0 ↑ 10.3* ↘ 10.4* ↑ 9.6 ↘
 beste Teiler: 146.7 (9.), 153.4 (8.), 168.1 (1.)
 Trefferlage: 0.19 mm rechts, 0.84 mm hoch
 Streuwert: 2.25, horizontal: 2.20, vertikal: 2.30

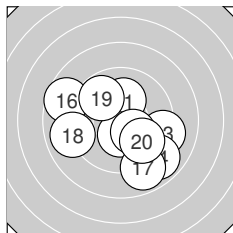

Serie 2: 95.2 (90)

10.2* ↑ 10.4* ↓ 9.2 → 8.9 ↘ 10.3* ↘
 8.7 ↖ 8.9 ↘ 9.0 ← 9.8 ↖ 9.8 ↘
 beste Teiler: 142.1 (12.), 169.7 (15.), 199.1 (11.)
 Trefferlage: 0.16 mm rechts, 0.95 mm tief
 Streuwert: 2.86, horizontal: 3.29, vertikal: 2.36

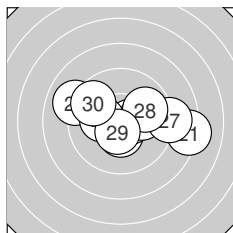

Serie 3: 97.6 (94)

8.2 → 10.4* ↓ 10.6* → 9.0 ↖ 10.1 →
 10.2* ← 9.0 → 9.9 ↗ 10.5* ↓ 9.7 ↖
 beste Teiler: 98.1 (23.), 109.4 (29.), 134.0 (22.)
 Trefferlage: 0.77 mm rechts, 0.18 mm hoch
 Streuwert: 2.56, horizontal: 3.44, vertikal: 1.15

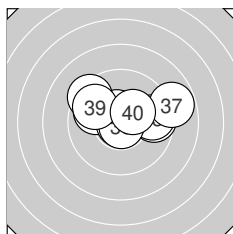

Serie 4: 99.6 (93)

9.9 ↖ 9.6 → 9.7 → 10.5* ↖ 10.8* ↘
 9.4 ↖ 8.8 → 10.8* ↓ 9.8 ↖ 10.3* ↘
 beste Teiler: 27.0 (35.), 39.8 (38.), 105.1 (34.)
 Trefferlage: 0.42 mm rechts, 0.88 mm hoch
 Streuwert: 2.05, horizontal: 2.76, vertikal: 0.89



Ergebnis: **388.7** (370)
 Serien: 95.1 97.0 99.7 96.9
 Zähler: 13 24 3 0 0 0 0 0 0 0 0
 Innenzehner: 10
 Weitester: 710 (6.), 522 (7.), 520 (20.)
 beste Teiler: 50.9 (22.), 70.2 (28.), 130.8 (12.)
 Trefferlage: 0.15 mm rechts, 0.53 mm hoch
 Streuwert: 2.39, horizontal: 2.55, vertikal: 2.21

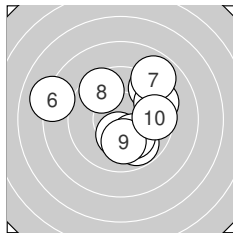
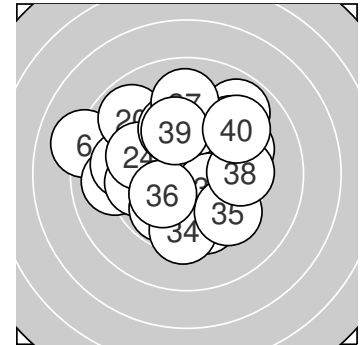

Serie 1: 95.1 (91)

9.8 ↘	9.2 ↗	10.3* ↓	10.1 ↘	9.4 ↗
8.1 ←	8.9 ↗	9.6 ↘	10.1 ↓	9.6 →

beste Teiler: 153.7 (3.), 210.6 (4.), 222.0 (9.)
 Trefferlage: 0.74 mm rechts, 0.61 mm hoch
 Streuwert: 2.85, horizontal: 3.21, vertikal: 2.43

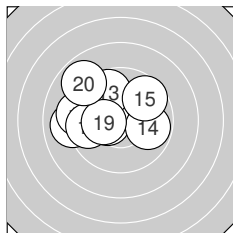

Serie 2: 97.0 (92)

10.3* ↑	10.4* ←	9.7 ↘	9.8 →	9.7 ↗
9.0 ←	9.3 ←	9.6 ←	10.3* ←	8.9 ↘

beste Teiler: 130.8 (12.), 166.2 (11.), 169.0 (19.)
 Trefferlage: 1.50 mm links, 0.88 mm hoch
 Streuwert: 2.15, horizontal: 2.60, vertikal: 1.59

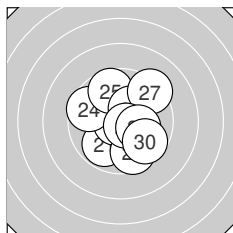

Serie 3: 99.7 (94)

9.8 ↗	10.8* ←	9.6 ↓	9.6 ←	9.7 ↗
10.3* ↗	9.3 ↗	10.7* ↘	10.2* →	9.7 ↘

beste Teiler: 50.9 (22.), 70.2 (28.), 161.4 (26.)
 Trefferlage: 0.36 mm rechts, 0.01 mm tief
 Streuwert: 2.01, horizontal: 1.91, vertikal: 2.11

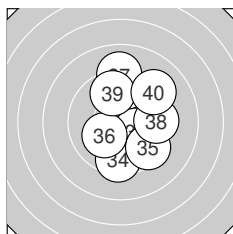

Serie 4: 96.9 (93)

10.4* ↗	9.6 ↑	10.3* ↘	9.5 ↓	9.5 ↘
10.1 ↗	9.0 ↑	9.5 →	9.8 ↗	9.2 ↗

beste Teiler: 143.1 (31.), 175.9 (33.), 207.5 (36.)
 Trefferlage: 1.00 mm rechts, 0.64 mm hoch
 Streuwert: 2.35, horizontal: 1.78, vertikal: 2.80



Ergebnis: **362.3** (345)
 Serien: 90.8 90.9 88.0 92.6
 Zähler: 9 14 12 3 2 0 0 0 0 0 0
 Innenzehner: 8
 Weitester: 1135 (26.), 1064 (16.), 965 (34.)
 beste Teiler: 56.9 (40.), 100.8 (39.), 148.1 (15.)
 Trefferlage: 1.64 mm rechts, 0.33 mm hoch
 Streuwert: 3.73, horizontal: 4.44, vertikal: 2.85

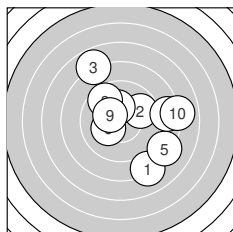
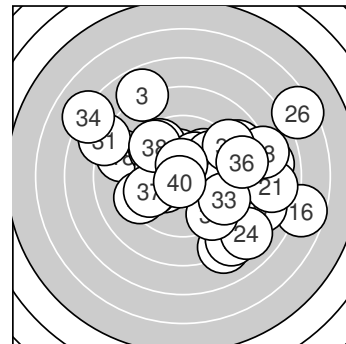

Serie 1: 90.8 (87)

8.1 ↘ 9.8 ↗ 7.8 ↘ 10.2* ↑ 8.3 ↘
 10.2* ↙ 8.5 → 9.6 ↘ 10.3* ↖ 8.0 →
 beste Teiler: 158.6 (9.), 184.0 (6.), 186.7 (4.)
 Trefferlage: 1.63 mm rechts, 0.50 mm hoch
 Streuwert: 3.72, horizontal: 3.90, vertikal: 3.54

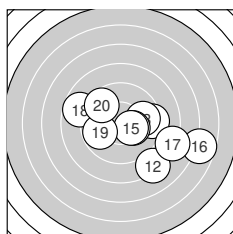

Serie 2: 90.9 (86)

9.3 → 8.2 ↘ 9.8 → 10.3* ↘ 10.4* ↘
 6.7 → 8.1 ↘ 8.7 ↖ 9.8 ↙ 9.6 ↘
 beste Teiler: 148.1 (15.), 169.7 (14.), 289.9 (19.)
 Trefferlage: 2.06 mm rechts, 0.85 mm tief
 Streuwert: 3.69, horizontal: 4.66, vertikal: 2.35

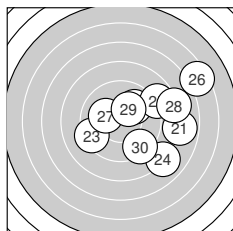

Serie 3: 88.0 (84)

7.9 → 9.9 ↗ 9.3 ↖ 8.0 ↘ 8.8 ↗
 6.4 ↗ 10.1 ↖ 8.1 → 10.2* ↗ 9.3 ↘
 beste Teiler: 186.9 (29.), 205.6 (27.), 258.1 (22.)
 Trefferlage: 3.44 mm rechts, 0.33 mm hoch
 Streuwert: 3.76, horizontal: 4.32, vertikal: 3.09

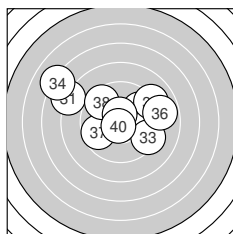

Serie 4: 92.6 (88)

8.0 ↖ 9.8 ↗ 9.3 ↘ 7.1 ↖ 9.1 ↗
 8.8 → 9.7 ↖ 9.5 ↘ 10.6* ↑ 10.7* ↙
 beste Teiler: 56.9 (40.), 100.8 (39.), 297.0 (32.)
 Trefferlage: 0.56 mm links, 1.36 mm hoch
 Streuwert: 3.55, horizontal: 4.53, vertikal: 2.17



Ergebnis: **389.1** (371)
 Serien: 97.6 96.6 98.7 96.2
 Zähler: 14 23 3 0 0 0 0 0 0 0
 Innenzehner: 8
 Weitester: 633 (37.), 548 (14.), 534 (38.)
 beste Teiler: 95.8 (27.), 97.7 (10.), 99.7 (26.)
 Trefferlage: 0.00 mm , 1.35 mm hoch
 Streuwert: 2.18, horizontal: 2.12, vertikal: 2.24

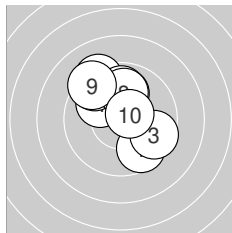
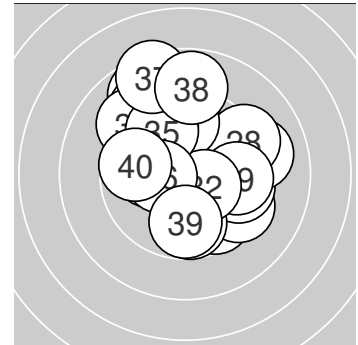

Serie 1: 97.6 (94)

9.6 ↘	10.0 ↑	9.6 →	10.0 ↖	9.4 ↙
9.2 ↙	9.9 ↑	10.0 ↑	9.3 ↖	10.6* ↗

beste Teiler: 97.7 (10.), 241.4 (4.), 244.2 (2.)
 Trefferlage: 0.24 mm links, 1.54 mm hoch
 Streuwert: 2.04, horizontal: 1.94, vertikal: 2.12

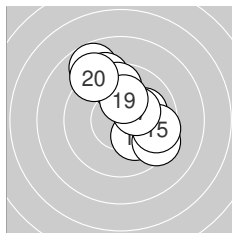

Serie 2: 96.6 (93)

10.2* ↘	10.1 →	9.4 ↘	8.8 ↙	9.6 →
9.2 ↙	10.3* ↗	9.7 ↑	10.2* ↑	9.1 ↙

beste Teiler: 167.9 (17.), 197.1 (19.), 198.2 (11.)
 Trefferlage: 0.50 mm rechts, 1.53 mm hoch
 Streuwert: 2.31, horizontal: 2.17, vertikal: 2.44

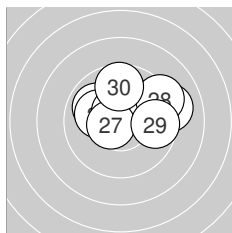

Serie 3: 98.7 (93)

9.8 →	9.9 ↖	10.1 ↖	9.1 →	9.9 ↑
10.6* ↙	10.6* ↖	9.3 ↗	9.7 →	9.7 ↑

beste Teiler: 95.8 (27.), 99.7 (26.), 212.5 (23.)
 Trefferlage: 0.84 mm rechts, 1.23 mm hoch
 Streuwert: 1.92, horizontal: 2.46, vertikal: 1.16

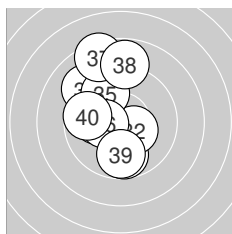

Serie 4: 96.2 (91)

9.7 ↓	10.4* ↘	9.2 ↖	10.1 ←	9.7 ↙
10.4* ←	8.4 ↑	8.8 ↑	9.8 ↓	9.7 ↖

beste Teiler: 142.6 (32.), 150.7 (36.), 218.8 (34.)
 Trefferlage: 1.14 mm links, 1.10 mm hoch
 Streuwert: 2.46, horizontal: 1.55, vertikal: 3.12

