

Ergebnis: 400.1 (384)
Serien: 99.5 100.3 98.0 102.3
Zähler: 26 12 2 0 0 0 0 0 0 0
Innenzehner: 21
Weiteste: 685 (25.), 552 (6.), 480 (20.)
beste Teiler: 42.4 (38.), 78.7 (39.), 89.0 (13.)
Trefferlage: 0.75 mm rechts, 0.55 mm hoch
Streuwert: 1.82, horizontal: 2.11, vertikal: 1.48

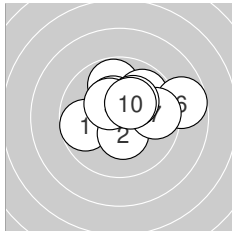
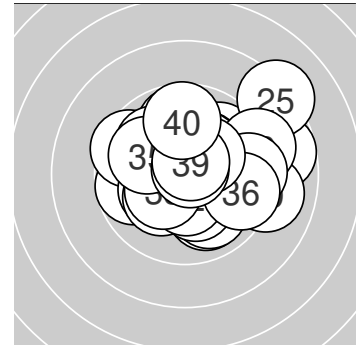

Serie 1: 99.5 (94)

9.7 ←	10.4* ↓	9.8 ↑	9.9 ↗	10.4* ↖
8.7 →	9.7 →	10.2* ↗	10.4* ↖	10.3* ↗

beste Teiler: 144.4 (9.), 145.1 (2.), 146.5 (5.)
Trefferlage: 0.79 mm rechts, 0.93 mm hoch
Streuwert: 1.86, horizontal: 2.33, vertikal: 1.23

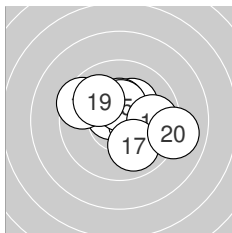

Serie 2: 100.3 (97)

10.2* ↗	10.4* ↑	10.6* ↘	10.4* →	10.4* ↑
9.8 →	10.0 ↓	9.5 ↖	10.0 ↖	9.0 →

beste Teiler: 89.0 (13.), 128.4 (15.), 131.0 (14.)
Trefferlage: 0.54 mm rechts, 0.42 mm hoch
Streuwert: 1.84, horizontal: 2.25, vertikal: 1.30

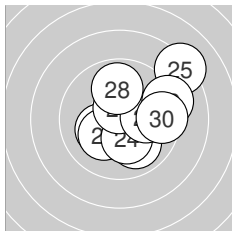

Serie 3: 98.0 (95)

10.2* ↖	10.2* ↖	10.0 ↓	10.2* ↓	8.2 ↗
10.6* ↑	10.0 →	9.9 ↑	9.2 →	9.5 →

beste Teiler: 98.2 (26.), 176.6 (24.), 186.5 (21.)
Trefferlage: 1.42 mm rechts, 0.39 mm hoch
Streuwert: 2.22, horizontal: 2.38, vertikal: 2.04

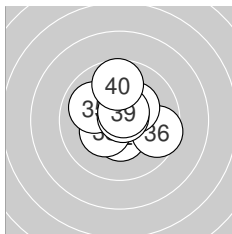

Serie 4: 102.3 (98)

10.3* →	10.4* ↓	10.3* ↖	10.3* ↖	10.0 ↖
9.6 →	10.3* ↗	10.8* ↗	10.6* ↗	9.7 ↑

beste Teiler: 42.4 (38.), 78.7 (39.), 133.3 (32.)
Trefferlage: 0.27 mm rechts, 0.45 mm hoch
Streuwert: 1.45, horizontal: 1.53, vertikal: 1.36



Ergebnis: 404.8 (386)
Serien: 100.8 102.7 104.1 97.2
Zähler: 29 10 0 0 1 0 0 0 0 0
Innenzehner: 19
Weiteste: 1014 (32.), 346 (6.), 333 (4.)
beste Teiler: 11.7 (26.), 35.5 (29.), 36.0 (14.)
Trefferlage: 0.04 mm rechts, 0.35 mm hoch
Streuwert: 1.84, horizontal: 2.32, vertikal: 1.18

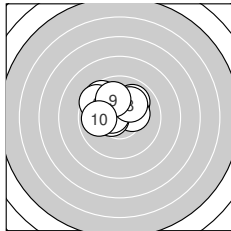
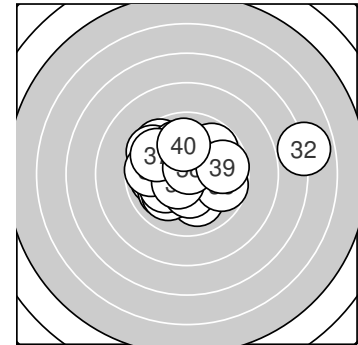

Serie 1: 100.8 (97)

10.0 ↗	10.3* →	10.3* ↘	9.6 ↖	10.5* ←
9.6 ↖	10.5* ←	10.1 ↗	10.0 ↑	9.9 ←

beste Teiler: 102.3 (7.), 105.5 (5.), 156.2 (3.)
Trefferlage: 0.73 mm links, 1.14 mm hoch
Streuwert: 1.40, horizontal: 1.71, vertikal: 1.01

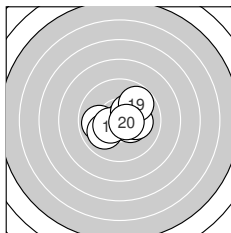

Serie 2: 102.7 (98)

9.9 ←	10.4* ↗	10.4* ↘	10.8* →	10.0 ↙
10.4* ↙	10.3* ↗	10.1 →	9.8 ↗	10.6* →

beste Teiler: 36.0 (14.), 89.9 (20.), 126.2 (12.)
Trefferlage: 0.31 mm rechts, 0.03 mm hoch
Streuwert: 1.36, horizontal: 1.64, vertikal: 1.00

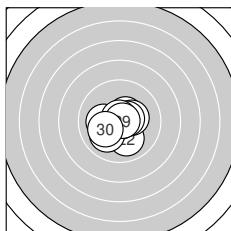

Serie 3: 104.1 (100)

10.5* ↗	10.0 ↓	10.1 ←	10.3* →	10.6* →
10.9* →	10.8* ↑	10.0 ↙	10.8* →	10.1 ↙

beste Teiler: 11.7 (26.), 35.5 (29.), 44.9 (27.)
Trefferlage: 0.10 mm links, 0.29 mm tief
Streuwert: 1.14, horizontal: 1.27, vertikal: 1.00

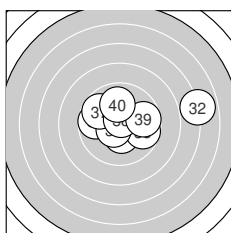

Serie 4: 97.2 (91)

10.4* ↓	6.9 →	9.7 →	9.9 ←	9.7 ←
10.5* ↙	9.7 ↖	10.7* ↑	9.7 →	10.0 ↑

beste Teiler: 58.1 (38.), 101.9 (36.), 148.9 (31.)
Trefferlage: 0.71 mm rechts, 0.51 mm hoch
Streuwert: 2.88, horizontal: 3.86, vertikal: 1.30



Ergebnis: **393.8** (377)
 Serien: 96.5 98.9 100.3 98.1
 Zähler: 22 15 2 0 1 0 0 0 0 0 0
 Innenzehner: 17
 Weitester: 1023 (2.), 565 (31.), 514 (36.)
 beste Teiler: 43.0 (32.), 50.3 (25.), 59.8 (18.)
 Trefferlage: 0.26 mm links, 1.17 mm hoch
 Streuwert: 2.20, horizontal: 2.60, vertikal: 1.73

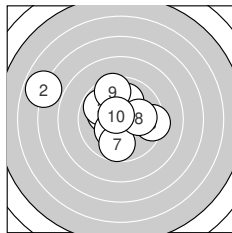
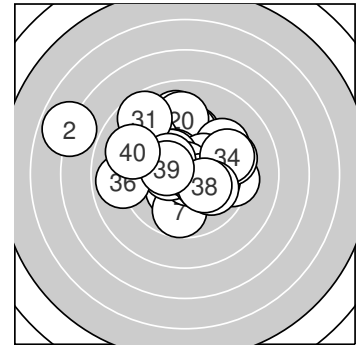

Serie 1: 96.5 (92)

10.2* ←	6.9 ↖	9.8 ↖	10.0 ↑	10.3* ↗
9.4 →	9.7 ↓	10.0 →	9.5 ↑	10.7* ↘

beste Teiler: 75.0 (10.), 164.8 (5.), 198.2 (1.)
 Trefferlage: 0.99 mm links, 0.75 mm hoch
 Streuwert: 2.91, horizontal: 3.55, vertikal: 2.07

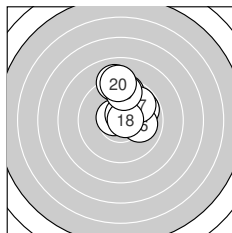

Serie 2: 98.9 (94)

9.1 ↑	9.8 ↗	9.6 ↑	10.6* ↖	10.6* ↑
10.0 →	9.8 ↗	10.7* →	9.6 ↑	9.1 ↑

beste Teiler: 59.8 (18.), 78.3 (15.), 85.6 (14.)
 Trefferlage: 0.71 mm rechts, 1.99 mm hoch
 Streuwert: 1.59, horizontal: 1.23, vertikal: 1.89

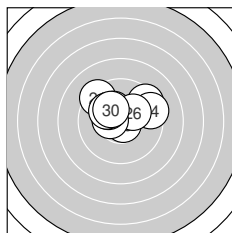

Serie 3: 100.3 (97)

9.3 ↘	9.4 ↗	10.3* ↘	9.4 →	10.8* ↘
10.2* ↗	10.4* ←	10.2* ↘	10.1 ↖	10.2* ↘

beste Teiler: 50.3 (25.), 129.3 (27.), 168.5 (23.)
 Trefferlage: 0.07 mm links, 1.27 mm hoch
 Streuwert: 1.67, horizontal: 2.17, vertikal: 0.94

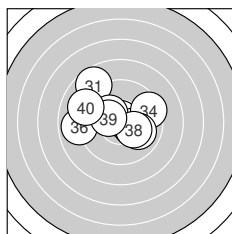

Serie 4: 98.1 (94)

8.7 ↘	10.8* ↑	10.4* ↘	9.4 →	10.3* ↘
8.9 ←	10.0 ↘	10.2* ↘	10.3* ↖	9.1 ↖

beste Teiler: 43.0 (32.), 141.9 (33.), 157.8 (39.)
 Trefferlage: 0.70 mm links, 0.67 mm hoch
 Streuwert: 2.39, horizontal: 2.91, vertikal: 1.71



Ergebnis: **382.6** (368)
 Serien: 93.7 95.4 93.0 100.5
 Zähler: 15 19 5 1 0 0 0 0 0 0
 Innenzehner: 11
 Weitester: 808 (18.), 743 (25.), 691 (10.)
 beste Teiler: 36.7 (19.), 66.4 (33.), 92.6 (39.)
 Trefferlage: 0.10 mm rechts, 0.48 mm tief
 Streuwert: 2.82, horizontal: 3.48, vertikal: 1.94

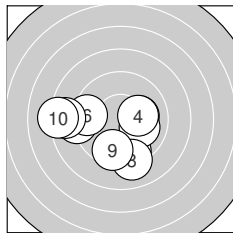
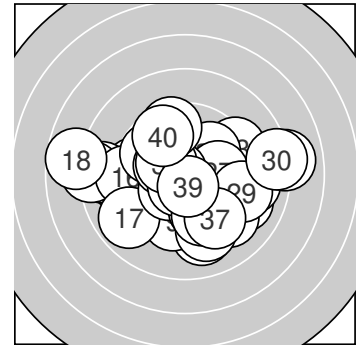

Serie 1: 93.7 (91)

10.1 →	9.5 ↓	10.0 →	10.2* →	9.0 ←
9.5 ←	8.5 ←	9.1 ↓	9.6 ↓	8.2 ←

beste Teiler: 195.9 (4.), 204.1 (1.), 226.3 (3.)
 Trefferlage: 1.40 mm links, 1.11 mm tief
 Streuwert: 2.89, horizontal: 3.62, vertikal: 1.91

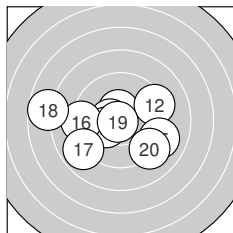

Serie 2: 95.4 (91)

10.5* ↑	9.3 →	10.5* ←	10.2* ↖	9.1 ↘
9.2 ←	8.9 ↗	7.7 ←	10.8* ↖	9.2 ↘

beste Teiler: 36.7 (19.), 114.4 (13.), 114.5 (11.)
 Trefferlage: 0.85 mm links, 0.54 mm tief
 Streuwert: 3.04, horizontal: 3.93, vertikal: 1.74

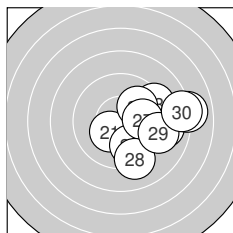

Serie 3: 93.0 (91)

10.3* ↖	9.0 →	9.3 →	10.0 ↗	8.0 →
9.8 ↓	10.0 →	9.2 ↓	9.2 →	8.2 →

beste Teiler: 164.7 (21.), 243.8 (27.), 244.4 (24.)
 Trefferlage: 3.24 mm rechts, 0.40 mm tief
 Streuwert: 2.33, horizontal: 2.64, vertikal: 1.97

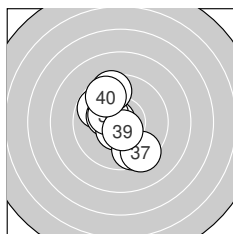

Serie 4: 100.5 (95)

9.8 ↘	10.3* ↖	10.7* ↖	10.6* ↖	10.3* ↖
9.6 ↓	9.4 ↓	9.5 ↑	10.6* ↓	9.7 ↖

beste Teiler: 66.4 (33.), 92.6 (39.), 98.6 (34.)
 Trefferlage: 0.55 mm links, 0.14 mm hoch
 Streuwert: 1.87, horizontal: 1.43, vertikal: 2.21



Ergebnis: **390.3** (373)
 Serien: 94.5 96.9 98.5 100.4
 Zähler: 18 19 2 0 1 0 0 0 0 0 0
 Innenzehner: 12
 Weitester: 1178 (5.), 700 (39.), 654 (12.)
 beste Teiler: 41.7 (23.), 48.8 (40.), 63.6 (32.)
 Trefferlage: 0.11 mm rechts, 0.26 mm hoch
 Streuwert: 2.57, horizontal: 3.12, vertikal: 1.86

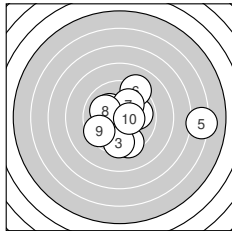
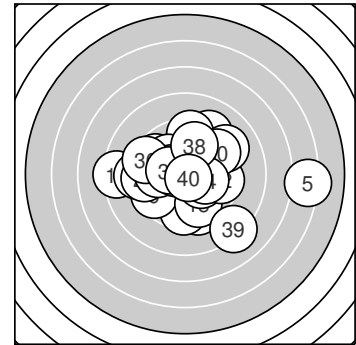

Serie 1: 94.5 (91)

10.2* ↘ 9.4 ↓ 9.5 ↓ 9.9 → 6.2 →
 9.2 ↗ 10.1 ↗ 10.1 ↖ 9.5 ↖ 10.4* →
 beste Teiler: 138.3 (10.), 184.2 (1.), 222.1 (7.)
 Trefferlage: 1.39 mm rechts, 0.18 mm tief
 Streuwert: 3.34, horizontal: 4.09, vertikal: 2.36

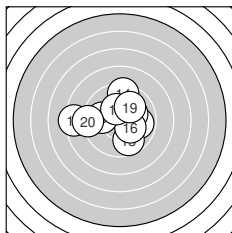

Serie 2: 96.9 (93)

9.9 → 8.3 ← 10.1 ↗ 9.4 ↑ 9.7 ↓
 10.2* ↘ 9.9 ← 10.3* ↗ 10.0 ↗ 9.1 ←
 beste Teiler: 164.8 (18.), 184.7 (16.), 202.1 (13.)
 Trefferlage: 0.48 mm links, 0.41 mm hoch
 Streuwert: 2.52, horizontal: 3.07, vertikal: 1.80

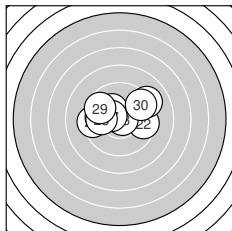

Serie 3: 98.5 (93)

9.4 ← 9.6 → 10.8* → 9.1 ↗ 10.2* ↖
 9.9 ← 10.4* ↖ 9.9 ← 9.7 ↖ 9.5 ↗
 beste Teiler: 41.7 (23.), 127.5 (27.), 178.8 (25.)
 Trefferlage: 0.34 mm links, 0.73 mm hoch
 Streuwert: 2.17, horizontal: 2.88, vertikal: 1.07

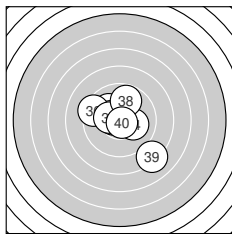

Serie 4: 100.4 (96)

10.1 ↖ 10.7* ↗ 10.4* ↖ 10.1 → 10.6* ←
 9.4 ← 10.3* ← 9.8 ↗ 8.2 ↘ 10.8* ↘
 beste Teiler: 48.8 (40.), 63.6 (32.), 88.5 (35.)
 Trefferlage: 0.09 mm links, 0.10 mm hoch
 Streuwert: 2.21, horizontal: 2.29, vertikal: 2.12



Ergebnis: **384.4** (368)
 Serien: 99.0 93.6 98.0 93.8
 Zähler: 14 21 4 1 0 0 0 0 0 0
 Innenzehner: 8
 Weitester: 813 (13.), 606 (40.), 604 (19.)
 beste Teiler: 64.8 (30.), 75.5 (5.), 101.5 (15.)
 Trefferlage: 0.35 mm rechts, 0.36 mm hoch
 Streuwert: 2.64, horizontal: 3.04, vertikal: 2.17

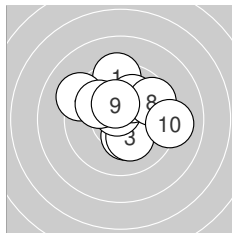
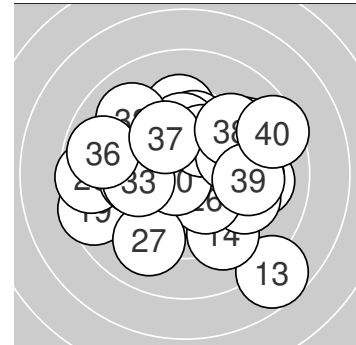

Serie 1: 99.0 (96)

9.4 ↑	10.3* ↓	10.2* ↓	9.2 ↖	10.7* ↗
10.1 ↗	10.0 ↖	9.6 ↗	10.4* ↗	9.1 →

beste Teiler: 75.5 (5.), 150.8 (9.), 161.2 (2.)
 Trefferlage: 0.29 mm rechts, 0.95 mm hoch
 Streuwert: 2.06, horizontal: 2.34, vertikal: 1.73

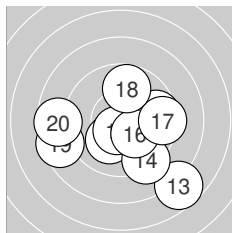

Serie 2: 93.6 (89)

10.1 ↖	9.6 →	7.7 ↘	9.2 ↘	10.5* ↓
10.2* ↘	9.4 →	9.8 ↑	8.5 ←	8.6 ←

beste Teiler: 101.5 (15.), 183.9 (16.), 209.1 (11.)
 Trefferlage: 0.40 mm rechts, 1.27 mm tief
 Streuwert: 3.18, horizontal: 3.78, vertikal: 2.45

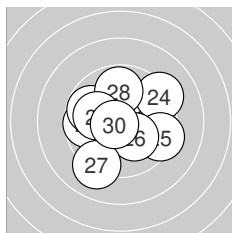

Serie 3: 98.0 (94)

9.7 ←	10.0 →	9.8 ↖	9.2 ↗	9.4 ↘
10.2* ↘	9.1 ↖	9.8 ↑	10.1 ←	10.7* ↖

beste Teiler: 64.8 (30.), 194.8 (26.), 224.6 (29.)
 Trefferlage: 0.03 mm links, 0.01 mm hoch
 Streuwert: 2.32, horizontal: 2.59, vertikal: 2.01

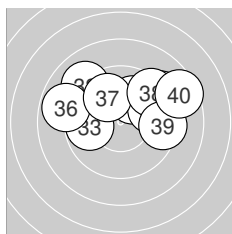

Serie 4: 93.8 (89)

10.0 ↗	9.1 ↖	9.8 ←	9.2 ↗	9.7 ↗
8.8 ←	9.9 ↗	9.4 ↗	9.4 →	8.5 ↗

beste Teiler: 234.8 (31.), 259.4 (37.), 290.4 (33.)
 Trefferlage: 0.74 mm rechts, 1.75 mm hoch
 Streuwert: 2.71, horizontal: 3.62, vertikal: 1.29



Ergebnis: **397.2** (379)
 Serien: 98.9 99.5 97.8 101.0
 Zähler: 23 14 2 1 0 0 0 0 0 0
 Innenzehner: 18
 Weitester: 865 (30.), 713 (19.), 584 (34.)
 beste Teiler: 15.6 (20.), 27.6 (39.), 39.0 (38.)
 Trefferlage: 0.06 mm links, 1.03 mm hoch
 Streuwert: 2.12, horizontal: 2.33, vertikal: 1.87

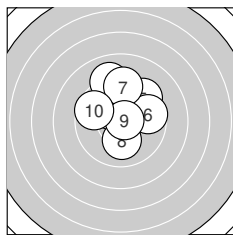
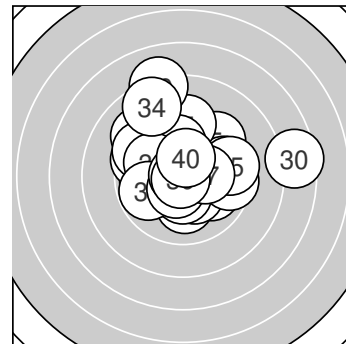

Serie 1: 98.9 (95)

10.1 ↗ 10.4* ↗ 10.3* ↘ 9.1 ↗ 9.5 ↗
 9.6 → 9.4 ↑ 10.1 ↓ 10.8* → 9.6 ↖
 beste Teiler: 45.6 (9.), 148.1 (2.), 158.6 (3.)
 Trefferlage: 0.32 mm rechts, 1.54 mm hoch
 Streuwert: 1.86, horizontal: 1.82, vertikal: 1.91

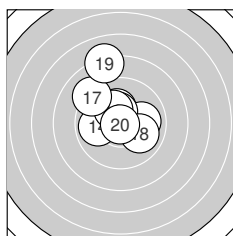

Serie 2: 99.5 (96)

10.2* ↑ 10.0 → 10.7* ↘ 9.9 ← 10.4* ↑
 10.2* ↘ 9.1 ↖ 10.0 ↘ 8.1 ↑ 10.9* ↙
 beste Teiler: 15.6 (20.), 56.3 (13.), 136.1 (15.)
 Trefferlage: 0.51 mm links, 1.35 mm hoch
 Streuwert: 2.08, horizontal: 1.83, vertikal: 2.30

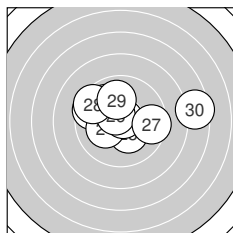

Serie 3: 97.8 (93)

9.9 ↖ 9.5 ↖ 10.3* ↘ 10.2* ← 10.8* ↗
 10.6* ↖ 9.5 → 9.5 ↖ 10.0 ↑ 7.5 →
 beste Teiler: 39.8 (25.), 87.2 (26.), 167.5 (23.)
 Trefferlage: 0.23 mm rechts, 0.73 mm hoch
 Streuwert: 2.68, horizontal: 3.55, vertikal: 1.30

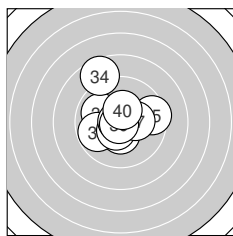

Serie 4: 101.0 (95)

9.9 ↖ 10.4* ↓ 9.8 ← 8.6 ↖ 9.5 →
 10.5* ↙ 10.3* → 10.8* ← 10.8* ↗ 10.4* ↑
 beste Teiler: 27.6 (39.), 39.0 (38.), 110.0 (36.)
 Trefferlage: 0.29 mm links, 0.50 mm hoch
 Streuwert: 1.94, horizontal: 1.93, vertikal: 1.94



LG 40 ZR

StandNr: 52

Kristandl, Manfred #523**Senioren_1m**

Wertung

ST – SV RB Eggersdorf / Steiermark 1

StartNr: 105

22.03.2024 11:36

Ergebnis: **399.8** (381)
 Serien: 97.9 99.6 100.2 102.1
 Zähler: 22 17 1 0 0 0 0 0 0 0
 Innenzehner: 20
 Weitestе: 600 (34.), 462 (1.), 408 (3.)
 beste Teiler: 55.0 (24.), 106.9 (37.), 108.6 (27.)
 Trefferlage: 0.37 mm links, 0.70 mm tief
 Streuwert: 1.83, horizontal: 2.20, vertikal: 1.35

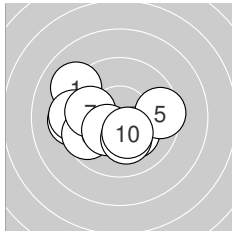
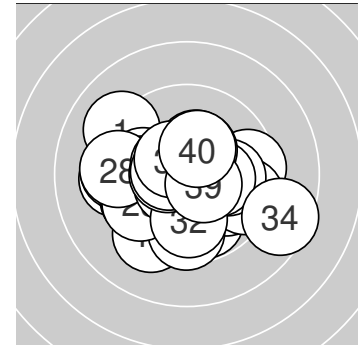
**Serie 1: 97.9 (94)**

9.1 ↘ 10.2* ↘ 9.3 ← 9.4 ← 9.5 →
 9.7 ← 9.9 ← 10.3* ↗ 10.2* ↓ 10.3* ↓

beste Teiler: 152.5 (10.), 156.2 (8.), 186.7 (2.)
 Trefferlage: 1.22 mm links, 0.38 mm tief
 Streuwert: 2.10, horizontal: 2.65, vertikal: 1.35

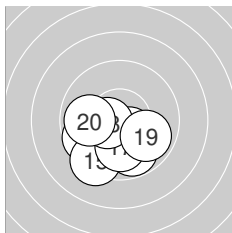
**Serie 2: 99.6 (94)**

9.8 ↓ 10.3* ↓ 9.8 ← 9.7 ← 9.3 ↗
 10.4* ↘ 10.0 ↓ 10.5* ← 9.9 ↘ 9.9 ←

beste Teiler: 108.9 (18.), 137.4 (16.), 172.4 (12.)
 Trefferlage: 0.66 mm links, 1.57 mm tief
 Streuwert: 1.48, horizontal: 1.81, vertikal: 1.05

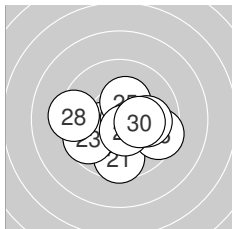
**Serie 3: 100.2 (96)**

9.6 ↓ 10.4* ↗ 9.7 ← 10.7* → 10.3* ↗
 9.5 ↘ 10.5* ↓ 9.3 ← 10.0 → 10.2* →

beste Teiler: 55.0 (24.), 108.6 (27.), 150.8 (22.)
 Trefferlage: 0.09 mm rechts, 0.67 mm tief
 Streuwert: 1.85, horizontal: 2.27, vertikal: 1.30

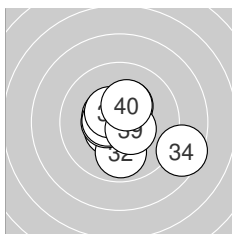
**Serie 4: 102.1 (97)**

10.5* ↗ 9.9 ↓ 10.5* ← 8.6 ↘ 10.5* ↘
 10.3* ↗ 10.5* ← 10.5* ↘ 10.5* ↘ 10.3* ↗

beste Teiler: 106.9 (37.), 109.6 (31.), 113.5 (39.)
 Trefferlage: 0.28 mm rechts, 0.19 mm tief
 Streuwert: 1.74, horizontal: 1.99, vertikal: 1.45



Ergebnis: **405.8** (390)
 Serien: 102.4 99.6 101.0 102.8
 Zähler: 31 8 1 0 0 0 0 0 0 0
 Innenzehner: 22
 Weitestе: 661 (16.), 416 (11.), 399 (2.)
 beste Teiler: 20.2 (37.), 29.6 (4.), 45.0 (33.)
 Trefferlage: 0.09 mm links, 0.56 mm hoch
 Streuwert: 1.63, horizontal: 1.79, vertikal: 1.45

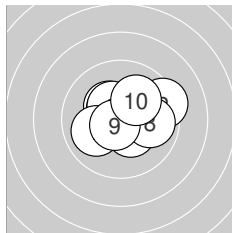
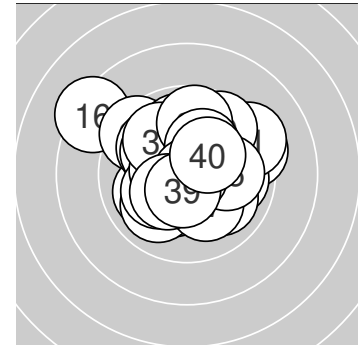

Serie 1: 102.4 (98)

10.3* ↖	9.4 →	10.4* ↖	10.8* ↓	10.4* ↖
10.4* ↓	10.0 ↙	9.9 →	10.7* ↗	10.1 ↗

beste Teiler: 29.6 (4.), 72.8 (9.), 126.0 (3.)
 Trefferlage: 0.35 mm rechts, 0.31 mm hoch
 Streuwert: 1.48, horizontal: 1.81, vertikal: 1.06

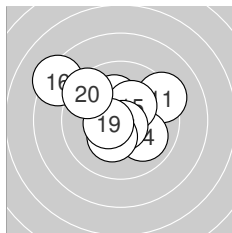

Serie 2: 99.6 (96)

9.3 ↗	10.6* ↓	10.2* ↑	10.0 ↘	10.3* ↗
8.3 ↖	10.7* ↓	10.3* ↙	10.5* ←	9.4 ↖

beste Teiler: 52.2 (17.), 88.2 (12.), 112.7 (19.)
 Trefferlage: 0.43 mm links, 0.65 mm hoch
 Streuwert: 2.19, horizontal: 2.54, vertikal: 1.76

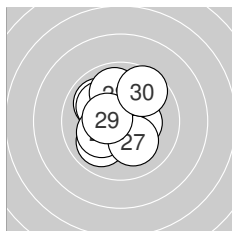

Serie 3: 101.0 (98)

10.4* →	10.0 ↖	10.2* ↖	10.0 ↙	10.1 ↖
10.2* ↙	10.1 ↓	9.9 ↑	10.5* ←	9.6 ↗

beste Teiler: 120.4 (29.), 146.5 (21.), 187.0 (23.)
 Trefferlage: 0.50 mm links, 0.53 mm hoch
 Streuwert: 1.57, horizontal: 1.46, vertikal: 1.67

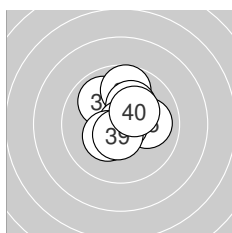

Serie 4: 102.8 (98)

10.1 ↑	9.9 ↖	10.8* ↓	9.7 ↑	10.0 →
10.2* ↗	10.9* ↘	10.3* ↙	10.6* ↓	10.3* ↗

beste Teiler: 20.2 (37.), 45.0 (33.), 96.3 (39.)
 Trefferlage: 0.22 mm rechts, 0.74 mm hoch
 Streuwert: 1.28, horizontal: 1.13, vertikal: 1.42



LG 40 ZR

StandNr: 54

Zöhrer, Stefan #525**Senioren_1m**

Wertung

ST – SV Weitendorf/Wildon / Steiermark 1

StartNr: 107

22.03.2024 11:54

Ergebnis: **375.5** (358)
 Serien: 94.0 95.8 92.5 93.2
 Zähler: 12 18 7 2 1 0 0 0 0 0
 Innenzehner: 9
 Weitester: 1016 (22.), 887 (15.), 756 (35.)
 beste Teiler: 101.5 (38.), 118.7 (13.), 140.9 (20.)
 Trefferlage: 0.56 mm links, 0.95 mm hoch
 Streuwert: 3.09, horizontal: 3.55, vertikal: 2.54

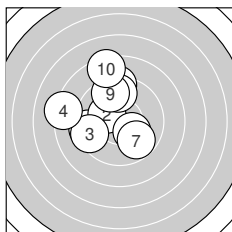
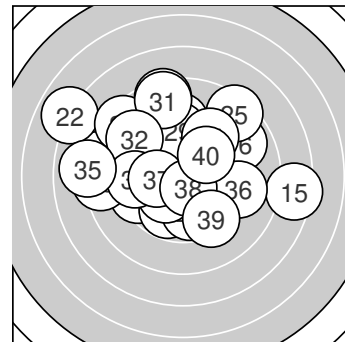
**Serie 1: 94.0 (90)**

9.4 ←	10.3* ↖	9.4 ←	8.2 ←	10.2* ↘
9.2 ↑	9.8 ↘	9.6 ↑	9.5 ↑	8.4 ↑

beste Teiler: 172.3 (2.), 190.2 (5.), 296.0 (7.)
 Trefferlage: 1.51 mm links, 1.35 mm hoch
 Streuwert: 2.73, horizontal: 2.59, vertikal: 2.86

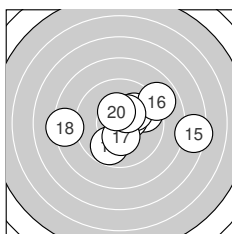
**Serie 2: 95.8 (91)**

9.8 ↙	9.7 ↗	10.5* ↗	10.1 ↗	7.4 →
8.9 ↗	10.3* ↓	8.3 ←	10.4* ↗	10.4* ↑

beste Teiler: 118.7 (13.), 140.9 (20.), 141.4 (19.)
 Trefferlage: 1.18 mm rechts, 0.21 mm hoch
 Streuwert: 3.02, horizontal: 3.94, vertikal: 1.64

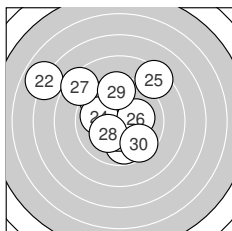
**Serie 3: 92.5 (87)**

9.6 ↖	6.9 ↖	9.8 ↓	9.9 ←	8.4 ↗
10.2* →	8.4 ↖	10.2* ↗	9.5 ↑	9.6 ↘

beste Teiler: 198.0 (26.), 198.7 (28.), 252.0 (24.)
 Trefferlage: 1.14 mm links, 1.40 mm hoch
 Streuwert: 3.42, horizontal: 3.79, vertikal: 3.00

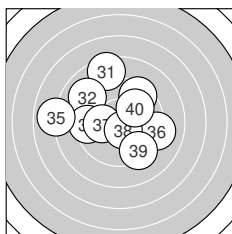
**Serie 4: 93.2 (90)**

8.5 ↑	9.0 ↖	9.4 ←	9.4 ↗	7.9 ←
9.1 →	10.1 ←	10.5* ↘	9.3 ↘	10.0 ↗

beste Teiler: 101.5 (38.), 207.9 (37.), 248.4 (40.)
 Trefferlage: 0.77 mm links, 0.85 mm hoch
 Streuwert: 3.19, horizontal: 3.64, vertikal: 2.66



Ergebnis: 388.9 (368)
Serien: 94.9 99.2 98.5 96.3
Zähler: 18 13 8 1 0 0 0 0 0 0
Innenzehner: 16
Weiteste: 778 (5.), 738 (16.), 615 (32.)
beste Teiler: 45.0 (15.), 89.1 (33.), 99.0 (10.)
Trefferlage: 0.42 mm links, 1.09 mm hoch
Streuwert: 2.43, horizontal: 3.14, vertikal: 1.41

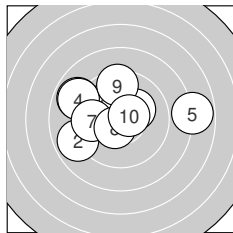
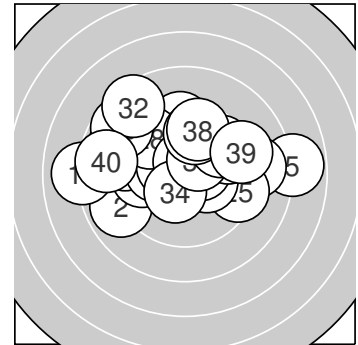

Serie 1: 94.9 (88)

9.9 ↖	8.9 ↙	8.9 ↖	8.9 ↖	7.8 →
10.2* ↗	9.7 ←	10.5* ↘	9.5 ↑	10.6* ↗

beste Teiler: 99.0 (10.), 110.9 (8.), 185.8 (6.)
Trefferlage: 0.97 mm links, 0.82 mm hoch
Streuwert: 2.97, horizontal: 3.83, vertikal: 1.72

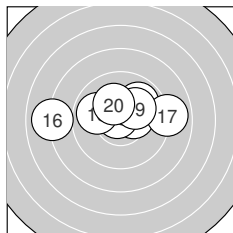

Serie 2: 99.2 (94)

10.5* ↑	10.5* ↖	9.9 ↗	10.4* →	10.8* ↖
8.0 ←	8.9 →	9.9 ↖	10.1 ↗	10.2* ↖

beste Teiler: 45.0 (15.), 102.0 (12.), 117.0 (11.)
Trefferlage: 0.17 mm links, 0.87 mm hoch
Streuwert: 2.34, horizontal: 3.25, vertikal: 0.63

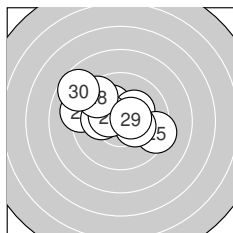

Serie 3: 98.5 (95)

9.2 ↖	10.2* ↖	10.1 ←	10.2* ↗	9.4 →
10.3* →	10.4* ↖	9.5 ↖	10.5* →	8.7 ↖

beste Teiler: 114.8 (29.), 136.5 (27.), 165.7 (26.)
Trefferlage: 0.77 mm links, 0.91 mm hoch
Streuwert: 2.16, horizontal: 2.73, vertikal: 1.37

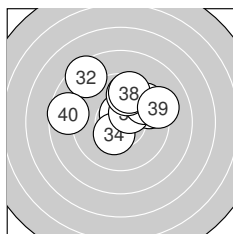

Serie 4: 96.3 (91)

9.6 ↗	8.5 ↖	10.6* ↑	10.4* ↘	10.4* ↗
9.6 ↗	9.7 ↑	9.6 ↑	9.2 →	8.7 ←

beste Teiler: 89.1 (33.), 139.4 (35.), 145.0 (34.)
Trefferlage: 0.22 mm rechts, 1.77 mm hoch
Streuwert: 2.43, horizontal: 3.01, vertikal: 1.65



LG 40 ZR

StandNr: 56

Brüstle, Robert #527**Senioren_1m**

Wertung

StartNr: 109

22.03.2024 11:33

T – SG Wattens / Tirol 2

Ergebnis: **400.5** (380)
 Serien: 102.3 97.7 99.7 100.8
 Zähler: 21 18 1 0 0 0 0 0 0 0
 Innenzehner: 16
 Weitestе: 644 (12.), 419 (19.), 402 (15.)
 beste Teiler: 11.1 (17.), 33.6 (9.), 51.8 (4.)
 Trefferlage: 0.28 mm links, 0.24 mm tief
 Streuwert: 1.88, horizontal: 2.10, vertikal: 1.65

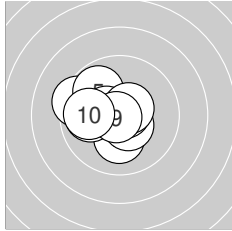
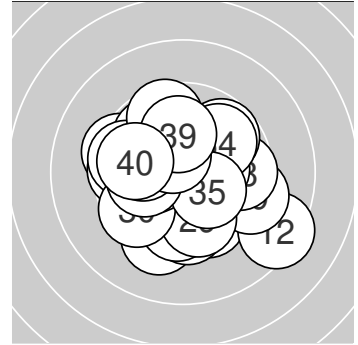
**Serie 1: 102.3 (96)**

9.4 ←	10.2* ↓	10.5* ↘	10.7* →	9.8 ↖
10.5* ←	9.9 ←	10.6* ↗	10.8* ←	9.9 ←

beste Teiler: 33.6 (9.), 51.8 (4.), 99.0 (8.)
 Trefferlage: 1.02 mm links, 0.14 mm hoch
 Streuwert: 1.38, horizontal: 1.61, vertikal: 1.10

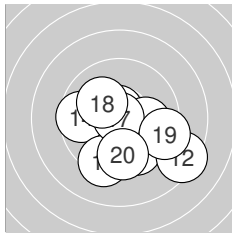
**Serie 2: 97.7 (93)**

9.7 ↓	8.4 ↘	10.7* ↑	9.6 ←	9.3 ↓
10.0 →	10.9* ↖	10.1 ↖	9.3 →	9.7 ↓

beste Teiler: 11.1 (17.), 68.4 (13.), 206.7 (18.)
 Trefferlage: 0.68 mm rechts, 1.26 mm tief
 Streuwert: 2.31, horizontal: 2.67, vertikal: 1.88

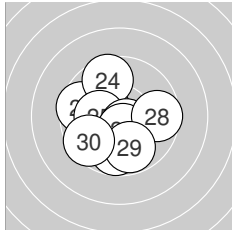
**Serie 3: 99.7 (94)**

9.6 ←	9.8 ↓	10.4* ↖	9.6 ↑	10.2* ←
10.6* ↘	10.5* ↓	9.6 →	9.8 ↓	9.6 ↗

beste Teiler: 93.0 (26.), 116.6 (27.), 131.6 (23.)
 Trefferlage: 0.53 mm links, 0.52 mm tief
 Streuwert: 1.89, horizontal: 1.93, vertikal: 1.85

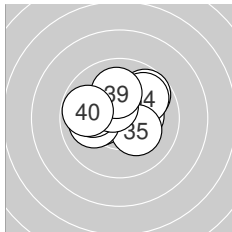
**Serie 4: 100.8 (97)**

9.7 ↗	10.3* ←	10.3* →	9.9 ↗	10.2* ↘
10.0 ←	10.0 ←	10.5* ↖	10.1 ↑	9.8 ←

beste Teiler: 117.4 (38.), 167.0 (33.), 170.6 (32.)
 Trefferlage: 0.25 mm links, 0.68 mm hoch
 Streuwert: 1.60, horizontal: 1.98, vertikal: 1.08



Ergebnis: **390.3** (375)
 Serien: 93.3 98.6 96.8 101.6
 Zähler: 19 19 1 0 1 0 0 0 0 0
 Innenzehner: 12
 Weitester: 1109 (2.), 720 (1.), 494 (40.)
 beste Teiler: 10.8 (32.), 63.2 (33.), 71.1 (38.)
 Trefferlage: 0.45 mm links, 0.53 mm tief
 Streuwert: 2.50, horizontal: 2.97, vertikal: 1.91

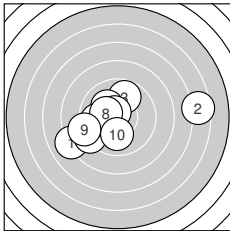
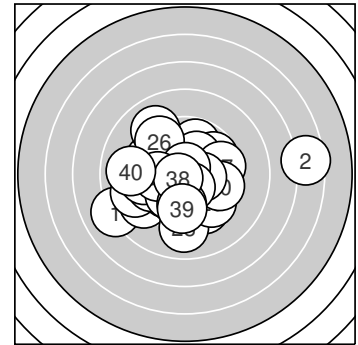

Serie 1: 93.3 (90)

8.1 ↙	6.5 →	9.8 ↑	10.1 ↘	9.1 ↙
9.8 ↙	10.6* ↘	10.3* ↙	9.0 ↙	10.0 ↓

beste Teiler: 80.2 (7.), 168.3 (8.), 207.2 (4.)
 Trefferlage: 0.89 mm links, 0.36 mm tief
 Streuwert: 3.65, horizontal: 4.73, vertikal: 2.06

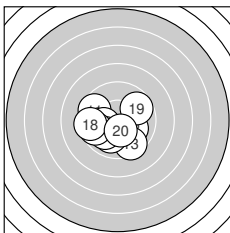

Serie 2: 98.6 (95)

9.6 ↘	10.1 ↘	9.5 ↘	10.2* ↙	10.0 ↓
10.0 ↙	9.7 ↙	9.4 ↙	9.7 ↗	10.4* ↓

beste Teiler: 147.1 (20.), 196.9 (14.), 225.7 (12.)
 Trefferlage: 0.77 mm links, 0.89 mm tief
 Streuwert: 1.95, horizontal: 2.32, vertikal: 1.49

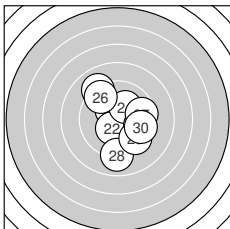

Serie 3: 96.8 (93)

10.4* ↘	10.4* ↙	9.0 ↘	10.2* ↗	9.7 →
9.4 ↘	9.6 →	9.0 ↓	9.5 ↘	9.6 →

beste Teiler: 147.3 (22.), 147.5 (21.), 196.4 (24.)
 Trefferlage: 0.63 mm rechts, 0.00 mm
 Streuwert: 2.48, horizontal: 2.29, vertikal: 2.66

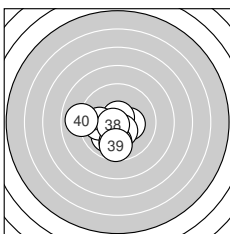

Serie 4: 101.6 (97)

10.3* →	10.9* ↘	10.7* ↑	10.0 ↙	10.0 ←
10.4* ↓	9.9 ↓	10.7* ↙	9.7 ↓	9.0 ←

beste Teiler: 10.8 (32.), 63.2 (33.), 71.1 (38.)
 Trefferlage: 0.79 mm links, 0.87 mm tief
 Streuwert: 1.57, horizontal: 1.81, vertikal: 1.30



Ergebnis: 381.7 (365)
Serien: 95.9 98.2 95.8 91.8
Zähler: 13 21 4 2 0 0 0 0 0 0 0
Innenzehner: 9
Weiteste: 927 (9.), 885 (39.), 692 (15.)
beste Teiler: 14.3 (12.), 82.3 (14.), 100.7 (17.)
Trefferlage: 1.56 mm rechts, 1.12 mm hoch
Streuwert: 2.54, horizontal: 2.77, vertikal: 2.29

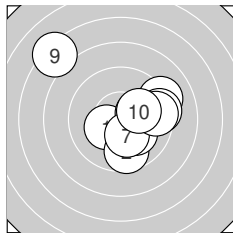
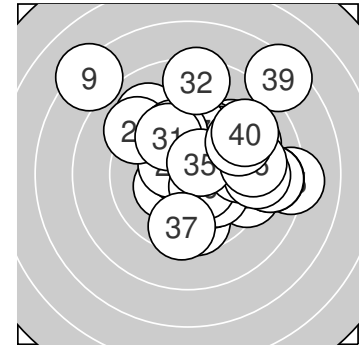

Serie 1: 95.9 (93)

10.3* ↖	9.6 ↓	9.2 ↗	10.2* ↗	10.1 ↘
9.4 →	10.3* ↓	9.5 →	7.2 ↖	10.1 ↗

beste Teiler: 163.4 (1.), 169.5 (7.), 180.9 (4.)
Trefferlage: 0.96 mm rechts, 0.44 mm hoch
Streuwert: 2.90, horizontal: 3.16, vertikal: 2.62

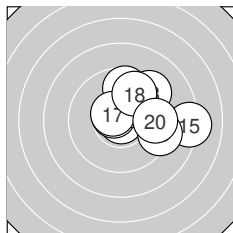

Serie 2: 98.2 (93)

9.7 ↑	10.9* ↓	9.4 ↗	10.6* ↖	8.2 →
10.1 ↗	10.6* ↖	9.8 ↗	9.3 →	9.6 →

beste Teiler: 14.3 (12.), 82.3 (14.), 100.7 (17.)
Trefferlage: 1.90 mm rechts, 0.93 mm hoch
Streuwert: 2.03, horizontal: 2.42, vertikal: 1.54

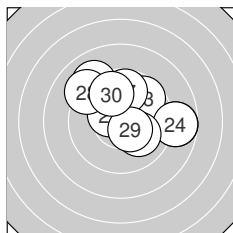

Serie 3: 95.8 (91)

8.7 →	10.4* ↖	9.7 ↗	8.7 →	10.1 ↘
9.1 ↖	9.7 ↑	9.2 ↖	10.4* ↘	9.8 ↗

beste Teiler: 126.9 (29.), 128.7 (22.), 223.4 (25.)
Trefferlage: 0.84 mm rechts, 1.27 mm hoch
Streuwert: 2.54, horizontal: 3.06, vertikal: 1.89

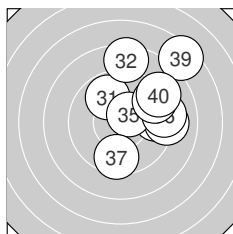

Serie 4: 91.8 (88)

9.8 ↖	8.4 ↑	9.5 →	9.1 →	10.5* ↗
9.2 →	9.5 ↓	9.3 ↗	7.4 ↗	9.1 ↗

beste Teiler: 113.2 (35.), 280.8 (31.), 352.5 (33.)
Trefferlage: 2.54 mm rechts, 1.83 mm hoch
Streuwert: 2.72, horizontal: 2.45, vertikal: 2.96



Ergebnis: **401.0** (385)
 Serien: 99.7 101.2 98.0 102.1
 Zähler: 26 13 1 0 0 0 0 0 0 0
 Innenzehner: 19
 Weitester: 512 (22.), 479 (23.), 456 (5.)
 beste Teiler: 21.5 (13.), 76.2 (3.), 89.9 (21.)
 Trefferlage: 0.40 mm rechts, 0.04 mm hoch
 Streuwert: 1.82, horizontal: 2.12, vertikal: 1.47

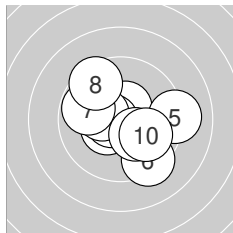
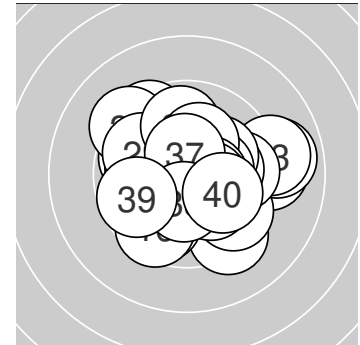

Serie 1: 99.7 (96)

10.5* ↗	10.4* ↙	10.6* ←	10.3* ←	9.1 →
9.3 ↘	9.8 ↖	9.5 ↘	10.2* ↘	10.0 ↘

beste Teiler: 76.2 (3.), 104.0 (1.), 134.7 (2.)
 Trefferlage: 0.24 mm rechts, 0.13 mm tief
 Streuwert: 2.02, horizontal: 2.30, vertikal: 1.71

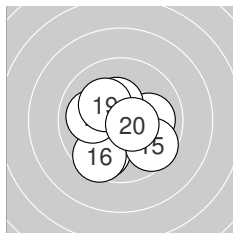

Serie 2: 101.2 (97)

10.0 →	10.3* ↘	10.9* ↖	9.7 ↙	9.6 ↘
9.6 ↙	10.0 ←	10.4* ↑	10.2* ↖	10.5* ↘

beste Teiler: 21.5 (13.), 104.0 (20.), 140.1 (18.)
 Trefferlage: 0.04 mm links, 0.60 mm tief
 Streuwert: 1.64, horizontal: 1.72, vertikal: 1.54

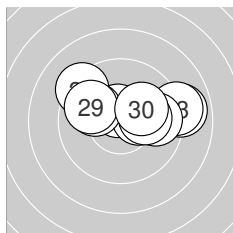

Serie 3: 98.0 (94)

10.6* ↑	8.9 →	9.0 →	10.3* →	9.8 →
10.0 ↖	10.1 →	9.3 ↘	9.9 ↖	10.1 ↗

beste Teiler: 89.9 (21.), 153.7 (24.), 203.9 (30.)
 Trefferlage: 0.99 mm rechts, 0.93 mm hoch
 Streuwert: 2.13, horizontal: 2.93, vertikal: 0.72

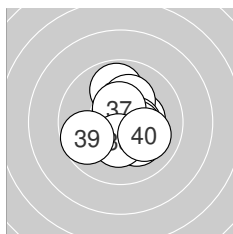

Serie 4: 102.1 (98)

9.9 ↑	10.3* →	10.2* ↑	10.2* ↘	10.5* →
10.4* ↘	10.5* ↑	10.3* ↓	9.7 ↙	10.1 ↘

beste Teiler: 115.6 (37.), 117.4 (35.), 127.4 (36.)
 Trefferlage: 0.44 mm rechts, 0.00 mm
 Streuwert: 1.43, horizontal: 1.39, vertikal: 1.46



LG 40 ZR

StandNr: 60

Lechner, Michael #530**Senioren_1m**

Wertung

NÖ – Priv. SG Ybbs / Niederösterreich 1

StartNr: 113

22.03.2024 11:53

Ergebnis: **389.4** (371)
 Serien: 96.7 95.8 97.5 99.4
 Zähler: 19 14 6 1 0 0 0 0 0 0
 Innenzehner: 13
 Weitester: 753 (40.), 635 (5.), 565 (6.)
 beste Teiler: 40.1 (31.), 54.1 (9.), 58.1 (30.)
 Trefferlage: 0.54 mm links, 0.22 mm tief
 Streuwert: 2.48, horizontal: 2.93, vertikal: 1.94

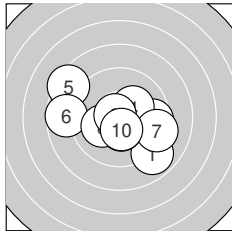
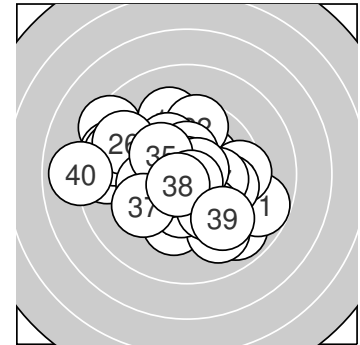
**Serie 1: 96.7 (92)**

8.9 ↘	10.4* ↓	9.6 →	10.2* ↗	8.4 ↖
8.7 ←	9.3 ↘	10.1 ←	10.7* ↖	10.4* ↓

beste Teiler: 54.1 (9.), 131.5 (10.), 136.1 (2.)
 Trefferlage: 0.07 mm links, 0.43 mm tief
 Streuwert: 2.77, horizontal: 3.44, vertikal: 1.87

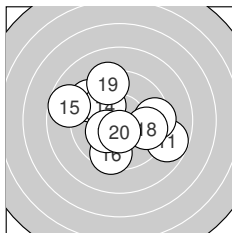
**Serie 2: 95.8 (91)**

8.8 ↘	9.5 →	9.4 ↖	10.1 ↖	8.7 ↖
9.5 ↓	10.2* ↗	9.8 →	9.3 ↗	10.5* ↓

beste Teiler: 121.0 (20.), 182.2 (17.), 219.9 (14.)
 Trefferlage: 0.20 mm links, 0.02 mm hoch
 Streuwert: 2.76, horizontal: 3.20, vertikal: 2.23

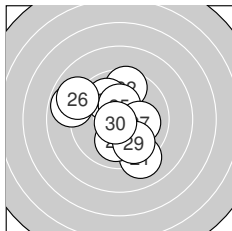
**Serie 3: 97.5 (94)**

9.1 ↘	9.6 ↑	10.0 ↖	8.8 ↖	10.4* ↑
9.0 ↖	10.1 →	10.0 ↓	9.8 ↘	10.7* ↗

beste Teiler: 58.1 (30.), 148.0 (25.), 213.8 (27.)
 Trefferlage: 0.52 mm links, 0.11 mm hoch
 Streuwert: 2.46, horizontal: 2.52, vertikal: 2.41

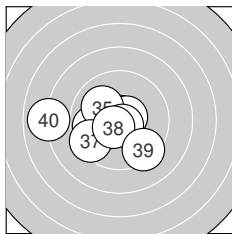
**Serie 4: 99.4 (94)**

10.8* ↑	9.8 ←	10.3* ↗	10.6* ↗	10.0 ↖
10.7* ↓	9.4 ↗	10.6* ↗	9.3 ↘	7.9 ←

beste Teiler: 40.1 (31.), 63.0 (36.), 78.7 (34.)
 Trefferlage: 1.36 mm links, 0.60 mm tief
 Streuwert: 2.15, horizontal: 2.74, vertikal: 1.30



Ergebnis: 406.5 (389)
Serien: 102.1 100.6 101.7 102.1
Zähler: 29 11 0 0 0 0 0 0 0 0
Innenzehner: 25
Weiteste: 447 (24.), 411 (39.), 397 (20.)
beste Teiler: 29.0 (6.), 36.4 (27.), 49.6 (17.)
Trefferlage: 0.48 mm links, 0.47 mm hoch
Streuwert: 1.55, horizontal: 1.85, vertikal: 1.17

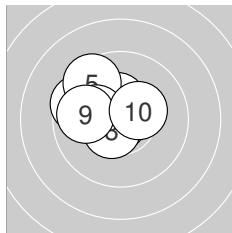
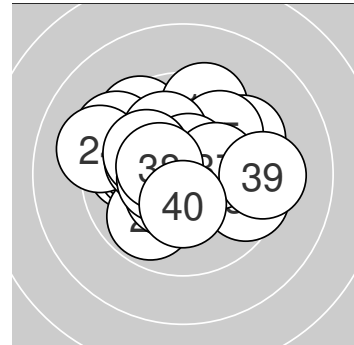

Serie 1: 102.1 (97)

10.6* ↗	9.6 ↖	10.4* ↑	10.3* ←	9.5 ↘
10.8* ↗	10.2* ↖	10.5* ↗	9.9 ←	10.3* ↗

beste Teiler: 29.0 (6.), 88.4 (1.), 104.8 (8.)
Trefferlage: 1.07 mm links, 0.65 mm hoch
Streuwert: 1.26, horizontal: 1.49, vertikal: 0.98

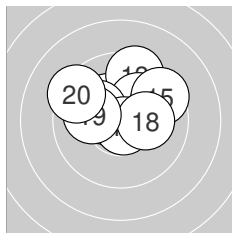

Serie 2: 100.6 (97)

10.3* ↘	10.4* ↖	9.5 ↑	10.2* ↗	9.5 ↗
10.2* ↖	10.8* ↘	10.2* →	10.1 ←	9.4 ↖

beste Teiler: 49.6 (17.), 136.6 (12.), 166.1 (11.)
Trefferlage: 0.20 mm links, 1.13 mm hoch
Streuwert: 1.67, horizontal: 2.06, vertikal: 1.16

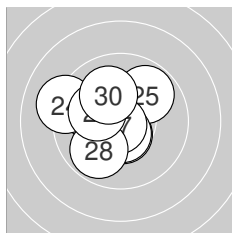

Serie 3: 101.7 (97)

10.0 ↖	10.5* ↓	10.6* ←	9.2 ↖	9.8 ↗
10.6* ↓	10.8* ↗	9.9 ↗	10.2* ↖	10.1 ↘

beste Teiler: 36.4 (27.), 91.4 (23.), 96.8 (26.)
Trefferlage: 0.97 mm links, 0.25 mm hoch
Streuwert: 1.53, horizontal: 1.67, vertikal: 1.39

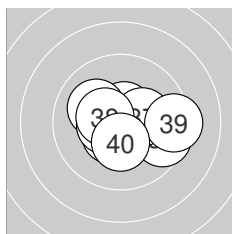

Serie 4: 102.1 (98)

10.6* ↑	10.5* ←	10.5* ↗	10.1 ↖	10.5* ←
9.6 →	10.3* →	10.4* ↖	9.3 →	10.3* ↓

beste Teiler: 92.3 (31.), 106.0 (32.), 119.4 (35.)
Trefferlage: 0.32 mm rechts, 0.12 mm tief
Streuwert: 1.57, horizontal: 2.04, vertikal: 0.88



Ergebnis: 385.3 (368)
Serien: 91.9 96.5 95.5 101.4
Zähler: 16 18 4 2 0 0 0 0 0 0
Innenzehner: 13
Weiteste: 851 (17.), 793 (2.), 692 (27.)
beste Teiler: 45.8 (31.), 60.4 (39.), 117.1 (15.)
Trefferlage: 0.01 mm links, 0.05 mm hoch
Streuwert: 2.73, horizontal: 3.07, vertikal: 2.33

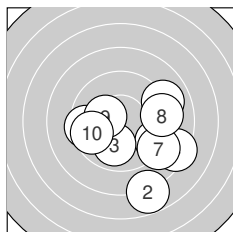
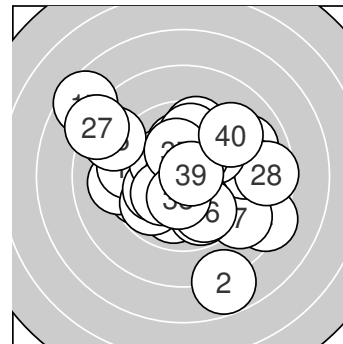

Serie 1: 91.9 (88)

9.2 ↘	7.8 ↓	9.9 ↓	8.3 ↘	9.0 →
9.5 ←	9.0 ↘	9.2 →	10.3* ←	9.7 ←

beste Teiler: 167.3 (9.), 252.5 (3.), 324.9 (10.)
Trefferlage: 1.62 mm rechts, 1.63 mm tief
Streuwert: 3.08, horizontal: 3.48, vertikal: 2.63

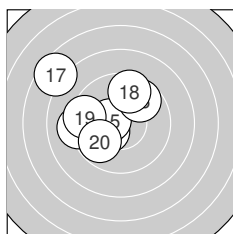

Serie 2: 96.5 (92)

10.2* ←	10.3* ←	9.2 ←	10.3* ←	10.5* ←
9.7 ↗	7.5 ↘	9.6 ↑	9.4 ←	9.8 ↗

beste Teiler: 117.1 (15.), 155.0 (12.), 175.7 (14.)
Trefferlage: 2.02 mm links, 0.76 mm hoch
Streuwert: 2.36, horizontal: 2.55, vertikal: 2.17

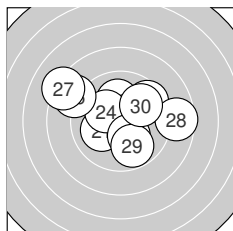

Serie 3: 95.5 (91)

10.1 ←	10.1 ↑	9.6 ↗	10.2* ↘	8.8 ↘
10.2* ↓	8.2 ↘	8.6 →	9.8 ↓	9.9 ↗

beste Teiler: 176.0 (26.), 184.4 (24.), 217.4 (21.)
Trefferlage: 0.18 mm links, 0.81 mm hoch
Streuwert: 2.88, horizontal: 3.57, vertikal: 1.96

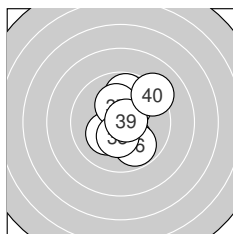

Serie 4: 101.4 (97)

10.8* ↘	10.2* ↗	10.2* ↗	9.8 ↑	10.1 ↓
9.8 ↓	10.2* ↑	10.4* ↓	10.7* →	9.2 ↗

beste Teiler: 45.8 (31.), 60.4 (39.), 149.0 (38.)
Trefferlage: 0.54 mm rechts, 0.26 mm hoch
Streuwert: 1.65, horizontal: 1.32, vertikal: 1.93



Ergebnis: **394.5** (378)
 Serien: 98.4 96.0 98.2 101.9
 Zähler: 20 18 2 0 0 0 0 0 0 0
 Innenzehner: 14
 Weitester: 668 (29.), 548 (13.), 483 (19.)
 beste Teiler: 33.2 (38.), 33.8 (25.), 75.4 (9.)
 Trefferlage: 0.29 mm rechts, 0.91 mm hoch
 Streuwert: 2.07, horizontal: 2.37, vertikal: 1.73

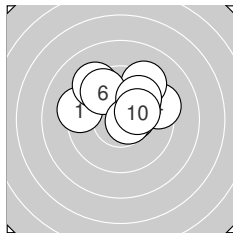
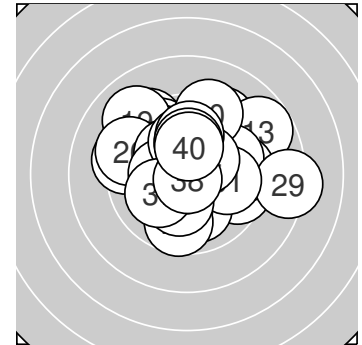

Serie 1: 98.4 (94)

9.3 ← 9.3 ↘ 10.1 ↗
 9.7 ↘ 10.5* → 9.9 ↗
 beste Teiler: 75.4 (9.), 121.2 (7.), 180.3 (10.)
 Trefferlage: 0.46 mm rechts, 1.60 mm hoch
 Streuwert: 1.92, horizontal: 2.40, vertikal: 1.27

9.4 → 9.3 ↗
 10.7* → 10.2* ↗

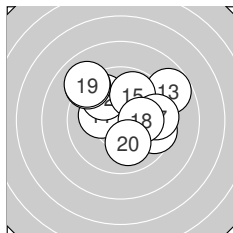

Serie 2: 96.0 (92)

10.2* ← 9.8 ↘ 8.8 ↗
 9.1 ↘ 9.6 → 10.1 →
 beste Teiler: 196.9 (11.), 201.0 (18.), 232.7 (20.)
 Trefferlage: 0.53 mm rechts, 1.20 mm hoch
 Streuwert: 2.48, horizontal: 2.90, vertikal: 1.97

9.6 → 9.8 ↗
 9.0 ↘ 10.0 ↓

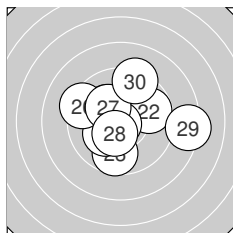

Serie 3: 98.2 (94)

10.2* ↘ 9.8 → 9.7 ↓
 9.3 ← 10.2* ↘ 10.4* ↓
 beste Teiler: 33.8 (25.), 132.8 (28.), 184.1 (27.)
 Trefferlage: 0.17 mm rechts, 0.27 mm hoch
 Streuwert: 2.46, horizontal: 2.87, vertikal: 1.98

10.2* ↖ 10.8* ↖
 8.3 → 9.3 ↗

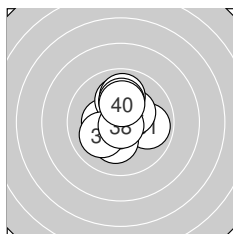

Serie 4: 101.9 (98)

9.9 → 10.3* ← 10.1 ↑
 10.2* ↓ 10.1 ↖ 10.8* ↓
 beste Teiler: 33.2 (38.), 153.6 (34.), 160.1 (32.)
 Trefferlage: 0.00 mm , 0.57 mm hoch
 Streuwert: 1.41, horizontal: 1.27, vertikal: 1.53

10.3* ↗ 9.9 ↑
 10.1 ↑ 10.2* ↑



Ergebnis: **386.7** (368)
 Serien: 94.4 96.9 97.6 97.8
 Zähler: 15 18 7 0 0 0 0 0 0 0
 Innenzehner: 9
 Weitester: 660 (2.), 656 (7.), 642 (12.)
 beste Teiler: 27.4 (8.), 70.0 (27.), 72.9 (39.)
 Trefferlage: 0.45 mm links, 0.45 mm hoch
 Streuwert: 2.56, horizontal: 2.91, vertikal: 2.15

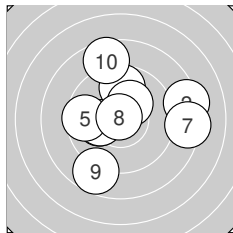
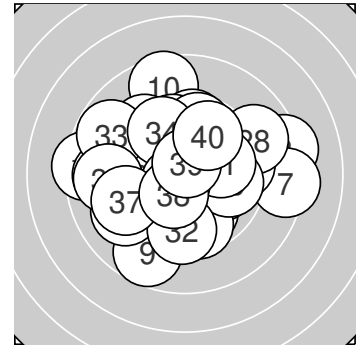

Serie 1: 94.4 (90)

10.1 ←	8.3 →	10.1 ←	9.7 ↑	9.6 ←
10.2* ↑	8.3 →	10.8* ↘	8.7 ↘	8.6 ↑

beste Teiler: 27.4 (8.), 178.8 (6.), 201.8 (3.)
 Trefferlage: 0.25 mm rechts, 0.60 mm hoch
 Streuwert: 3.18, horizontal: 3.53, vertikal: 2.78

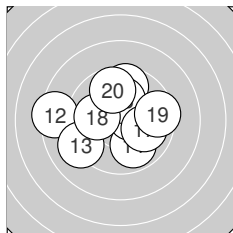

Serie 2: 96.9 (93)

9.6 ↑	8.4 ←	9.1 ←	9.9 ↓	10.5* →
10.2* ↑	10.0 →	10.0 ←	9.5 →	9.7 ↑

beste Teiler: 103.5 (15.), 195.8 (16.), 231.3 (18.)
 Trefferlage: 0.45 mm links, 0.42 mm hoch
 Streuwert: 2.53, horizontal: 2.99, vertikal: 1.95

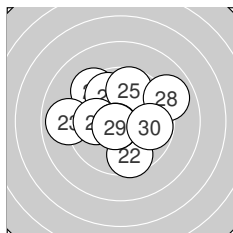

Serie 3: 97.6 (92)

9.4 ↘	9.6 ↓	8.9 ←	9.8 ↘	9.7 ↑
10.0 ←	10.7* ↘	9.0 →	10.7* ↘	9.8 →

beste Teiler: 70.0 (27.), 74.9 (29.), 237.0 (26.)
 Trefferlage: 0.33 mm links, 0.58 mm hoch
 Streuwert: 2.42, horizontal: 2.76, vertikal: 2.03

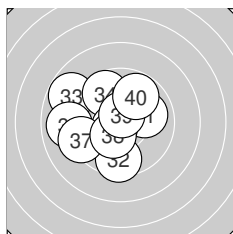

Serie 4: 97.8 (93)

10.0 →	9.5 ↓	8.8 ↘	9.7 ↘	9.0 ←
10.6* ↘	9.3 ←	10.4* ↘	10.7* ↑	9.8 ↑

beste Teiler: 72.9 (39.), 76.6 (36.), 146.4 (38.)
 Trefferlage: 1.26 mm links, 0.19 mm hoch
 Streuwert: 2.31, horizontal: 2.52, vertikal: 2.08



Ergebnis: 364.0 (348)
Serien: 96.8 85.2 95.7 86.3
Zähler: 12 20 6 0 0 0 0 0 0 2
Innenzehner: 9
Weiteste: 650 (14.), 573 (37.), 547 (25.)
beste Teiler: 55.9 (39.), 103.7 (23.), 111.4 (4.)
Trefferlage: 0.36 mm links, 0.77 mm hoch
Streuwert: 2.61, horizontal: 2.98, vertikal: 2.16

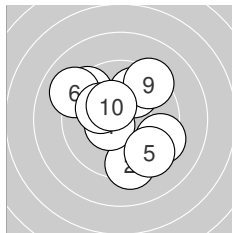
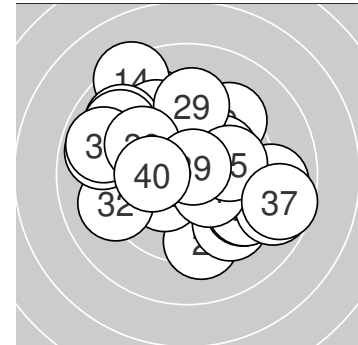

Serie 1: 96.8 (93)

9.4 ↘ 9.3 ↓ 9.4 ↘ 10.5* ↙ 9.4 ↘
 9.1 ↖ 9.9 ↗ 10.1 ↖ 9.3 ↗ 10.4* ↘

beste Teiler: 111.4 (4.), 146.1 (10.), 203.1 (8.)
Trefferlage: 0.00 mm , 0.34 mm hoch
Streuwert: 2.52, horizontal: 2.54, vertikal: 2.51

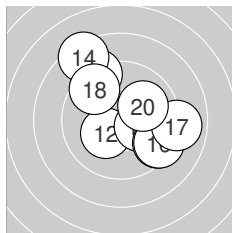

Serie 2: 85.2 (82)

9.1 ↖ 10.3* ↙ 10.2* → 8.4 ↖ 9.4 ↘
 9.4 ↘ 8.9 → 9.5 ↖ 0.0F_{MIS} 10.0 ↗

beste Teiler: 175.7 (12.), 176.1 (13.), 235.5 (20.)
Trefferlage: 0.70 mm rechts, 0.83 mm hoch
Streuwert: 2.89, horizontal: 3.01, vertikal: 2.76

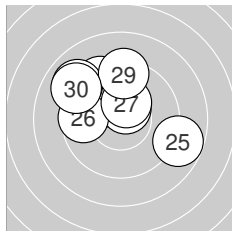

Serie 3: 95.7 (92)

9.6 ↖ 10.2* ↖ 10.5* ↗ 9.4 ↖ 8.8 →
 9.6 ← 10.3* ↗ 9.0 ↖ 9.3 ↑ 9.0 ↖

beste Teiler: 103.7 (23.), 156.5 (27.), 199.2 (22.)
Trefferlage: 1.08 mm links, 1.68 mm hoch
Streuwert: 2.34, horizontal: 2.80, vertikal: 1.76

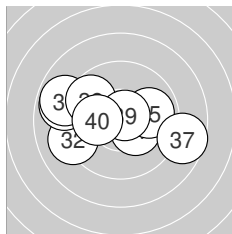

Serie 4: 86.3 (81)

10.3* ↘ 9.1 ← 0.0F_{MIS} 8.9 ↖ 9.9 →
 8.9 ↖ 8.7 → 9.7 ↖ 10.7* ↗ 10.1 ←

beste Teiler: 55.9 (39.), 160.5 (31.), 207.0 (40.)
Trefferlage: 1.02 mm links, 0.18 mm hoch
Streuwert: 2.77, horizontal: 3.68, vertikal: 1.35

MIS – Treffer wurde manuell eingefügt, da der Schütze die Scheibe verfehlt hat



Ergebnis: 391.2 (374)
Serien: 97.8 93.9 98.4 101.1
Zähler: 18 19 2 1 0 0 0 0 0 0
Innenzehner: 11
Weiteste: 905 (14.), 600 (29.), 521 (4.)
beste Teiler: 61.2 (23.), 71.8 (24.), 76.8 (37.)
Trefferlage: 0.06 mm links, 0.45 mm hoch
Streuwert: 2.38, horizontal: 2.66, vertikal: 2.06

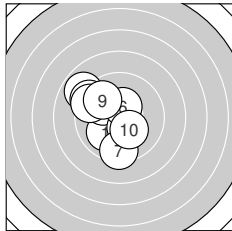
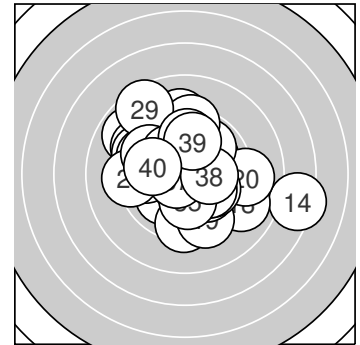

Serie 1: 97.8 (94)

10.0 ↙	10.0 ↘	10.4* ↘	8.9 ↘	9.3 ↘
10.4* ↑	9.4 ↓	9.4 ↖	9.8 ↘	10.2* ↘

beste Teiler: 129.6 (6.), 141.1 (3.), 183.2 (10.)
Trefferlage: 1.47 mm links, 0.31 mm hoch
Streuwert: 2.08, horizontal: 1.93, vertikal: 2.21

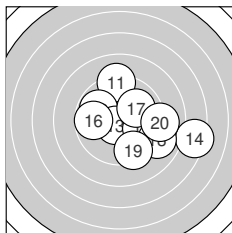

Serie 2: 93.9 (90)

9.2 ↑	9.8 ↘	10.6* ↙	7.3 →	9.8 →
9.7 ←	10.0 ↗	9.0 ↘	9.4 ↓	9.1 →

beste Teiler: 78.1 (13.), 239.6 (17.), 277.5 (15.)
Trefferlage: 1.76 mm rechts, 0.26 mm tief
Streuwert: 3.01, horizontal: 3.61, vertikal: 2.26

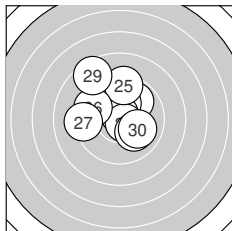

Serie 3: 98.4 (94)

9.9 ↗	10.2* ↑	10.7* ↑	10.7* ↘	9.4 ↑
9.6 ↖	9.2 ←	10.1 ↘	8.6 ↖	10.0 ↘

beste Teiler: 61.2 (23.), 71.8 (24.), 186.1 (22.)
Trefferlage: 0.37 mm links, 1.15 mm hoch
Streuwert: 2.23, horizontal: 2.30, vertikal: 2.16

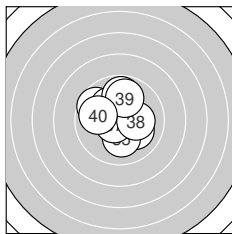

Serie 4: 101.1 (96)

10.6* ↗	9.7 ↘	10.1 ↘	10.2* ↘	10.1 ↓
9.8 ↑	10.6* ↙	10.2* →	9.9 ↑	9.9 ↖

beste Teiler: 76.8 (37.), 94.8 (31.), 191.2 (38.)
Trefferlage: 0.18 mm links, 0.61 mm hoch
Streuwert: 1.60, horizontal: 1.61, vertikal: 1.59



Ergebnis: **397.0** (378)
 Serien: 98.9 100.0 99.5 98.6
 Zähler: 19 20 1 0 0 0 0 0 0 0
 Innenzehner: 14
 Weitester: 575 (2.), 475 (12.), 431 (21.)
 beste Teiler: 37.0 (27.), 60.0 (23.), 78.8 (5.)
 Trefferlage: 0.37 mm links, 0.31 mm tief
 Streuwert: 2.02, horizontal: 2.29, vertikal: 1.71

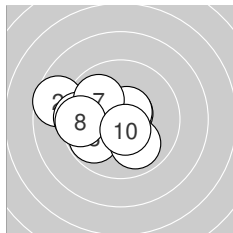
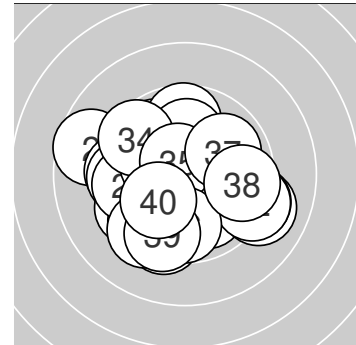

Serie 1: 98.9 (93)

9.8 ←	8.7 ←	9.8 ↙	9.5 ←	10.6* ↗
10.6* ↗	9.9 ↘	9.5 ←	10.0 ↘	10.5* ↘

beste Teiler: 78.8 (5.), 84.5 (6.), 102.0 (10.)
 Trefferlage: 1.71 mm links, 0.02 mm hoch
 Streuwert: 1.86, horizontal: 2.31, vertikal: 1.27

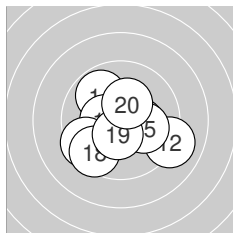

Serie 2: 100.0 (96)

10.3* →	9.1 ↘	10.6* ↓	9.8 ↘	10.1 →
10.4* ←	9.5 ↙	9.5 ↙	10.4* ↓	10.3* ↗

beste Teiler: 79.7 (13.), 126.6 (19.), 137.0 (16.)
 Trefferlage: 0.02 mm links, 0.60 mm tief
 Streuwert: 1.93, horizontal: 2.25, vertikal: 1.54

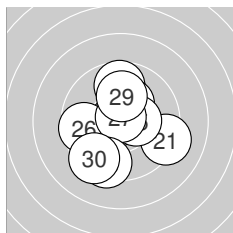

Serie 3: 99.5 (95)

9.2 ↘	9.7 ↑	10.7* ←	10.3* ↗	10.4* →
9.6 ←	10.8* ↑	9.4 ↓	10.1 ↑	9.3 ↙

beste Teiler: 37.0 (27.), 60.0 (23.), 138.0 (25.)
 Trefferlage: 0.12 mm links, 0.19 mm tief
 Streuwert: 2.11, horizontal: 2.01, vertikal: 2.21

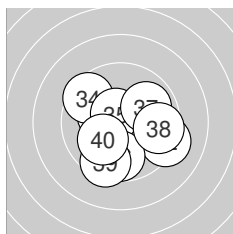

Serie 4: 98.6 (94)

10.1 →	9.2 ↘	10.3* ←	9.5 ↘	10.6* ↘
9.8 ↓	9.9 ↗	9.6 →	9.5 ↓	10.1 ↗

beste Teiler: 85.9 (35.), 168.9 (33.), 213.7 (31.)
 Trefferlage: 0.37 mm rechts, 0.46 mm tief
 Streuwert: 2.14, horizontal: 2.36, vertikal: 1.89



Ergebnis: **386.6** (367)
 Serien: 95.0 98.5 92.9 100.2
 Zähler: 15 20 3 1 1 0 0 0 0 0 0
 Innenzehner: 8
 Weitester: 1059 (30.), 891 (4.), 577 (11.)
 beste Teiler: 15.0 (19.), 53.3 (38.), 59.3 (16.)
 Trefferlage: 1.21 mm rechts, 0.96 mm hoch
 Streuwert: 2.48, horizontal: 3.03, vertikal: 1.76

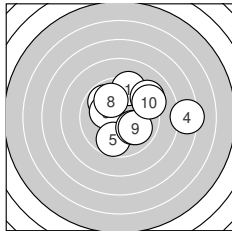
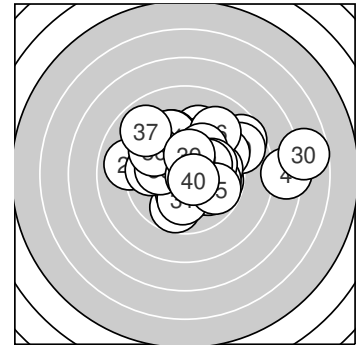

Serie 1: 95.0 (92)

9.4 ↗	9.8 ↘	10.2* ↖	7.4 →	9.7 ↓
10.1 ↘	9.2 ↗	10.0 ↘	10.0 ↘	9.2 ↗

beste Teiler: 189.0 (3.), 220.2 (6.), 247.3 (9.)
 Trefferlage: 1.57 mm rechts, 0.78 mm hoch
 Streuwert: 2.80, horizontal: 3.34, vertikal: 2.13

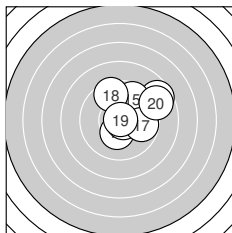

Serie 2: 98.5 (92)

8.6 ↗	10.3* ↓	10.5* →	9.8 →	9.6 ↗
10.7* ↘	9.8 →	9.5 ↘	10.9* ↗	8.8 ↗

beste Teiler: 15.0 (19.), 59.3 (16.), 102.3 (13.)
 Trefferlage: 1.73 mm rechts, 0.87 mm hoch
 Streuwert: 1.96, horizontal: 2.10, vertikal: 1.80

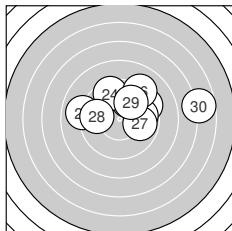

Serie 3: 92.9 (87)

9.0 ←	9.9 ↗	9.4 ↗	9.5 ↘	9.8 →
9.1 ↗	9.9 →	9.7 ←	9.9 ↗	6.7 →

beste Teiler: 267.1 (22.), 267.9 (29.), 273.9 (27.)
 Trefferlage: 1.55 mm rechts, 1.64 mm hoch
 Streuwert: 3.11, horizontal: 4.17, vertikal: 1.36

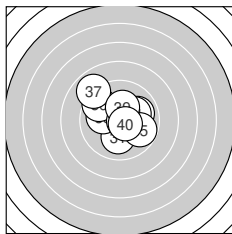

Serie 4: 100.2 (96)

10.1 ↓	10.0 →	10.1 ←	10.1 →	9.8 ↘
9.6 ↘	8.9 ↘	10.7* →	10.3* ↗	10.6* ↘

beste Teiler: 53.3 (38.), 89.0 (40.), 173.2 (39.)
 Trefferlage: 0.00 mm , 0.56 mm hoch
 Streuwert: 1.94, horizontal: 2.14, vertikal: 1.72



Ergebnis: 374.6 (357)
Serien: 93.7 92.3 93.2 95.4
Zähler: 9 23 5 2 1 0 0 0 0 0 0
Innenzehner: 4
Weiteste: 1056 (4.), 895 (22.), 812 (5.)
beste Teiler: 87.9 (8.), 133.7 (7.), 149.8 (19.)
Trefferlage: 0.90 mm rechts, 1.79 mm hoch
Streuwert: 2.82, horizontal: 3.46, vertikal: 2.00

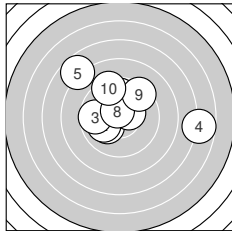
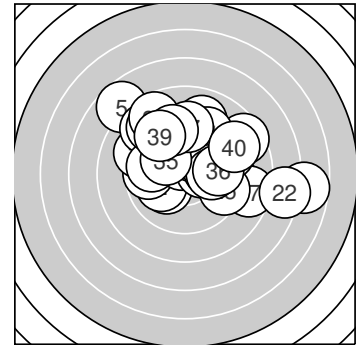

Serie 1: 93.7 (89)

10.1 ↙	10.0 ↙	9.7 ←	6.7 →	7.7 ↘
9.8 ↑	10.4* ↗	10.6* ↖	9.4 ↗	9.3 ↖

beste Teiler: 87.9 (8.), 133.7 (7.), 204.4 (1.)
Trefferlage: 0.00 mm , 1.36 mm hoch
Streuwert: 3.52, horizontal: 4.33, vertikal: 2.45

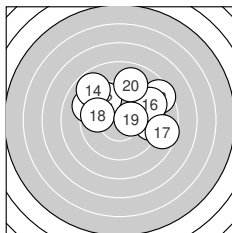

Serie 2: 92.3 (88)

9.2 ↘	9.6 ↘	8.5 ↗	8.8 ↘	9.3 →
9.1 ↗	8.6 →	9.8 ←	10.4* →	9.0 ↑

beste Teiler: 149.8 (19.), 300.0 (18.), 342.9 (12.)
Trefferlage: 0.94 mm rechts, 1.74 mm hoch
Streuwert: 3.02, horizontal: 3.77, vertikal: 2.00

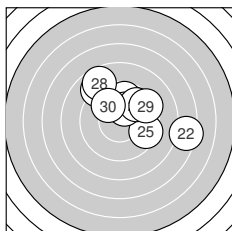

Serie 3: 93.2 (87)

9.8 ↗	7.4 →	8.9 ↘	9.7 ↑	9.5 →
10.3* ↑	9.7 ↗	8.7 ↘	9.3 ↗	9.9 ↘

beste Teiler: 171.7 (26.), 257.0 (30.), 290.8 (21.)
Trefferlage: 1.39 mm rechts, 1.93 mm hoch
Streuwert: 2.87, horizontal: 3.48, vertikal: 2.09

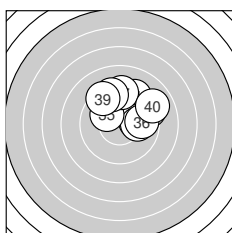

Serie 4: 95.4 (93)

9.3 ↑	9.2 ↗	10.1 →	10.0 →	10.1 ↘
9.8 →	9.3 ↑	9.3 ↖	9.3 ↘	9.0 ↗

beste Teiler: 211.2 (35.), 214.5 (33.), 236.0 (34.)
Trefferlage: 1.28 mm rechts, 2.12 mm hoch
Streuwert: 2.00, horizontal: 2.33, vertikal: 1.60

