

Ergebnis: 361.7 (343)
Serien: 92.6 96.1 82.9 90.1
Zähler: 13 11 7 7 1 0 0 1 0 0 0
Innenzehner: 9
Weiteste: 1770 (29.), 1070 (24.), 971 (21.)
beste Teiler: 31.6 (32.), 78.3 (2.), 110.6 (7.)
Trefferlage: 2.27 mm rechts, 0.69 mm tief
Streuwert: 3.87, horizontal: 4.92, vertikal: 2.41

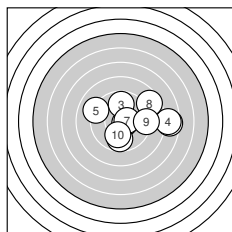
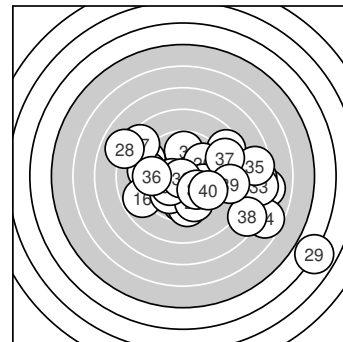

Serie 1: 92.6 (88)

7.5 →	10.6* ↘	9.8 ↑	7.6 →	9.1 ↖
9.7 ↓	10.5* →	8.6 ↗	9.2 →	10.0 ↓

beste Teiler: 78.3 (2.), 110.6 (7.), 239.0 (10.)
Trefferlage: 2.32 mm rechts, 0.19 mm hoch
Streuwert: 3.24, horizontal: 4.12, vertikal: 2.02

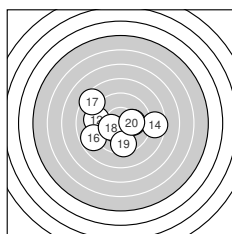

Serie 2: 96.1 (92)

10.4* ↓	9.3 ←	10.1 →	8.6 →	10.5* ↓
8.8 ↖	8.5 ↘	10.2* ←	9.5 ↓	10.2* →

beste Teiler: 118.2 (15.), 135.9 (11.), 178.1 (18.)
Trefferlage: 0.57 mm links, 0.49 mm tief
Streuwert: 2.81, horizontal: 3.46, vertikal: 1.96

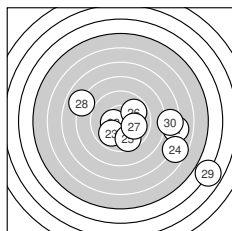

Serie 3: 82.9 (78)

7.1 →	10.4* ←	9.9 ↙	6.7 ↘	9.6 ↓
9.8 ↗	10.0 ↘	8.0 ↖	3.9 ↘	7.5 →

beste Teiler: 128.0 (22.), 250.2 (27.), 260.6 (23.)
Trefferlage: 3.93 mm rechts, 1.70 mm tief
Streuwert: 5.28, horizontal: 6.64, vertikal: 3.43

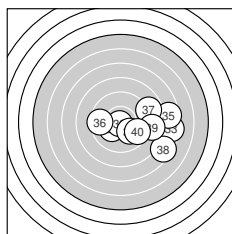

Serie 4: 90.1 (85)

10.2* ↖	10.8* ↙	7.4 →	10.1 ↘	7.6 →
9.5 ←	8.8 ↗	7.4 ↘	8.7 →	9.6 ↘

beste Teiler: 31.6 (32.), 187.8 (31.), 222.0 (34.)
Trefferlage: 3.41 mm rechts, 0.80 mm tief
Streuwert: 3.30, horizontal: 4.29, vertikal: 1.83



Ergebnis: **400.7** (380)
 Serien: 98.9 100.9 99.7 101.2
 Zähler: 23 14 3 0 0 0 0 0 0 0
 Innenzehner: 20
 Weitester: 593 (13.), 525 (2.), 508 (40.)
 beste Teiler: 34.8 (15.), 48.1 (17.), 49.0 (33.)
 Trefferlage: 0.25 mm rechts, 0.02 mm hoch
 Streuwert: 1.96, horizontal: 2.26, vertikal: 1.61

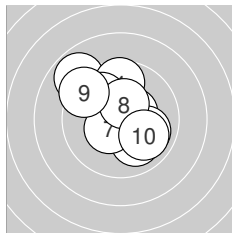
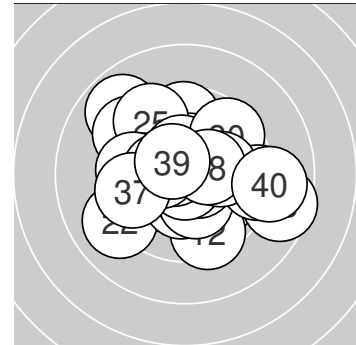

Serie 1: 98.9 (94)

10.0 ↘	8.9 ↖	10.5* ↗	9.6 ↑	10.0 ↘
9.9 ↖	10.4* ↗	10.4* ↑	9.3 ↖	9.9 ↘

beste Teiler: 123.4 (3.), 132.2 (7.), 142.4 (8.)
 Trefferlage: 0.27 mm links, 0.80 mm hoch
 Streuwert: 2.08, horizontal: 2.11, vertikal: 2.04

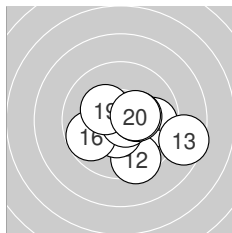

Serie 2: 100.9 (95)

9.8 →	9.5 ↓	8.6 →	10.5* ↓	10.8* ↗
9.8 ↖	10.8* ↘	10.4* →	10.3* ↖	10.4* →

beste Teiler: 34.8 (15.), 48.1 (17.), 117.0 (14.)
 Trefferlage: 0.90 mm rechts, 0.62 mm tief
 Streuwert: 1.87, horizontal: 2.29, vertikal: 1.32

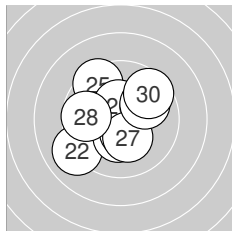

Serie 3: 99.7 (95)

10.6* ↓	9.0 ↖	10.3* ↓	10.5* ↓	9.4 ↖
10.4* ↑	10.3* ↓	9.7 ←	9.9 ↗	9.6 ↗

beste Teiler: 96.0 (21.), 121.1 (24.), 129.7 (26.)
 Trefferlage: 0.37 mm links, 0.02 mm hoch
 Streuwert: 2.02, horizontal: 2.08, vertikal: 1.95

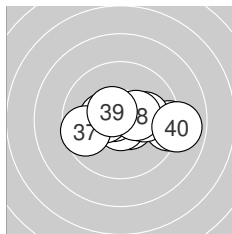

Serie 4: 101.2 (96)

10.6* ↘	9.2 →	10.8* ↓	10.7* ↖	10.4* ←
10.1 →	9.6 ↖	10.4* →	10.5* ↖	8.9 →

beste Teiler: 49.0 (33.), 72.8 (34.), 85.4 (31.)
 Trefferlage: 0.76 mm rechts, 0.09 mm tief
 Streuwert: 1.85, horizontal: 2.55, vertikal: 0.56



Ergebnis: **380.7** (361)
 Serien: 93.6 95.2 97.5 94.4
 Zähler: 15 13 10 2 0 0 0 0 0 0
 Innenzehner: 12
 Weitester: 795 (26.), 781 (16.), 709 (10.)
 beste Teiler: 39.0 (1.), 61.9 (27.), 77.6 (33.)
 Trefferlage: 1.80 mm rechts, 0.98 mm tief
 Streuwert: 2.59, horizontal: 2.74, vertikal: 2.43

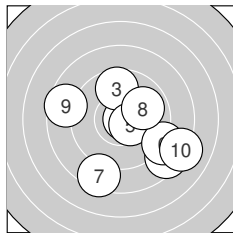
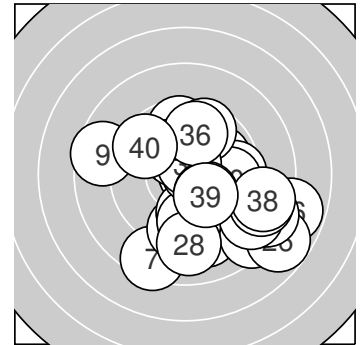

Serie 1: 93.6 (88)

10.8* →	10.2* →	9.7 ↑	8.5 ↘	10.5* ↘
8.9 ↘	8.4 ↓	9.9 →	8.6 ←	8.1 ↘

beste Teiler: 39.0 (1.), 114.0 (5.), 179.3 (2.)
 Trefferlage: 1.26 mm rechts, 0.96 mm tief
 Streuwert: 3.22, horizontal: 3.57, vertikal: 2.83

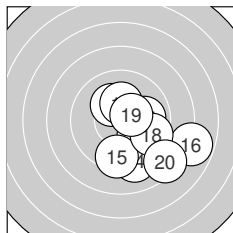

Serie 2: 95.2 (92)

10.2* ↖	10.2* ↑	10.0 ↘	9.2 ↓	9.4 ↓
7.8 ↘	10.0 →	9.5 ↘	10.5* →	8.4 ↘

beste Teiler: 125.2 (19.), 176.1 (12.), 185.0 (11.)
 Trefferlage: 2.10 mm rechts, 1.38 mm tief
 Streuwert: 2.43, horizontal: 2.52, vertikal: 2.34

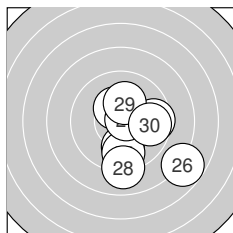

Serie 3: 97.5 (92)

10.4* ↖	10.6* →	9.6 →	9.9 ↓	9.6 ↓
7.8 ↘	10.7* →	9.0 ↓	10.2* ↑	9.7 →

beste Teiler: 61.9 (27.), 84.9 (22.), 149.0 (21.)
 Trefferlage: 1.50 mm rechts, 1.18 mm tief
 Streuwert: 2.32, horizontal: 2.19, vertikal: 2.46

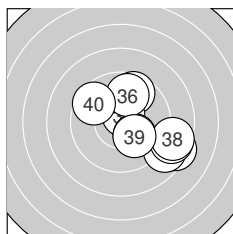

Serie 4: 94.4 (89)

9.6 ↑	8.4 ↘	10.6* ↑	8.7 ↘	10.2* ↘
9.8 ↑	8.7 ↘	8.7 ↘	10.1 ↘	9.6 ↘

beste Teiler: 77.6 (33.), 200.2 (35.), 206.4 (39.)
 Trefferlage: 2.36 mm rechts, 0.39 mm tief
 Streuwert: 2.58, horizontal: 2.81, vertikal: 2.33



Ergebnis: **395.3** (379)
 Serien: 96.8 98.9 99.4 100.2
 Zähler: 21 17 2 0 0 0 0 0 0 0
 Innenzehner: 16
 Weitester: 686 (3.), 626 (39.), 489 (16.)
 beste Teiler: 72.0 (9.), 81.6 (31.), 82.3 (19.)
 Trefferlage: 0.13 mm links, 0.58 mm hoch
 Streuwert: 2.12, horizontal: 2.55, vertikal: 1.57

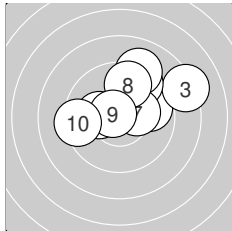
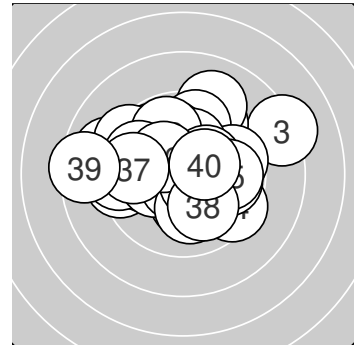

Serie 1: 96.8 (93)

9.8 →	10.2* ←	8.2 →	10.0 ↗	9.5 ↗
9.1 ↗	10.3* →	9.7 ↗	10.7* ↖	9.3 ←

beste Teiler: 72.0 (9.), 170.8 (7.), 195.0 (2.)
 Trefferlage: 0.98 mm rechts, 1.67 mm hoch
 Streuwert: 2.27, horizontal: 2.77, vertikal: 1.61

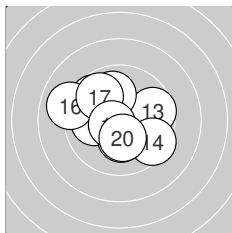

Serie 2: 98.9 (95)

9.7 ↖	10.0 ←	9.7 →	9.5 ↘	10.0 ↗
9.0 ←	9.8 ↖	10.3* ↓	10.6* ↖	10.3* ↓

beste Teiler: 82.3 (19.), 169.4 (20.), 175.5 (18.)
 Trefferlage: 0.61 mm links, 0.29 mm hoch
 Streuwert: 2.13, horizontal: 2.46, vertikal: 1.74

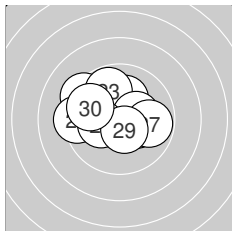

Serie 3: 99.4 (95)

10.2* ↗	9.3 ↖	9.8 ↖	9.3 ←	10.3* →
10.3* →	9.8 →	10.2* ←	10.5* ↓	9.7 ↖

beste Teiler: 109.6 (29.), 161.7 (26.), 165.7 (25.)
 Trefferlage: 0.61 mm links, 0.58 mm hoch
 Streuwert: 1.89, horizontal: 2.34, vertikal: 1.30

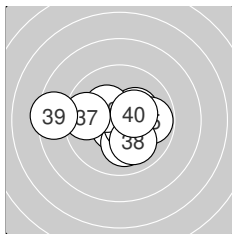

Serie 4: 100.2 (96)

10.6* ↗	10.1 ↓	10.3* →	10.6* ↘	9.8 →
10.3* ↖	9.7 ←	10.0 ↘	8.4 ←	10.4* →

beste Teiler: 81.6 (31.), 93.0 (34.), 149.9 (40.)
 Trefferlage: 0.29 mm links, 0.20 mm tief
 Streuwert: 2.05, horizontal: 2.67, vertikal: 1.13



Ergebnis: 383.1 (366)
Serien: 99.0 96.1 95.8 92.2
Zähler: 17 13 9 1 0 0 0 0 0 0
Innenzehner: 12
Weiteste: 852 (6.), 688 (37.), 661 (24.)
beste Teiler: 59.3 (35.), 85.7 (9.), 120.0 (5.)
Trefferlage: 0.82 mm rechts, 0.59 mm hoch
Streuwert: 2.74, horizontal: 3.19, vertikal: 2.19

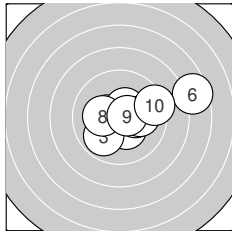
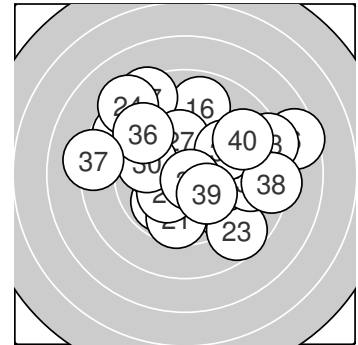

Serie 1: 99.0 (95)

10.3* ↘	10.4* ←	9.9 ↙	10.2* →	10.5* ↗
7.5 →	10.1 →	10.2* ←	10.6* →	9.3 →

beste Teiler: 85.7 (9.), 120.0 (5.), 139.0 (2.)
Trefferlage: 1.31 mm rechts, 0.22 mm hoch
Streuwert: 2.32, horizontal: 3.02, vertikal: 1.30

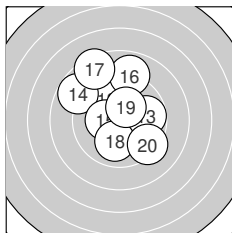

Serie 2: 96.1 (91)

10.5* ↘	9.8 ↘	9.8 →	8.8 ↘	10.3* ←
8.9 ↑	8.4 ↘	10.0 ↓	10.3* ↗	9.3 ↘

beste Teiler: 122.1 (11.), 159.0 (15.), 160.1 (19.)
Trefferlage: 0.23 mm links, 1.19 mm hoch
Streuwert: 2.66, horizontal: 2.46, vertikal: 2.85

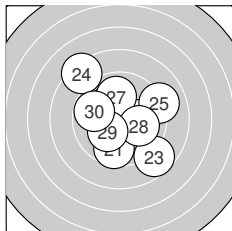

Serie 3: 95.8 (92)

9.6 ↓	10.0 →	8.7 ↘	8.3 ↘	9.1 →
10.2* ↘	9.9 ↑	10.0 →	10.2* ↙	9.8 ←

beste Teiler: 189.4 (26.), 190.2 (29.), 227.0 (22.)
Trefferlage: 0.22 mm rechts, 0.23 mm hoch
Streuwert: 2.80, horizontal: 2.84, vertikal: 2.76

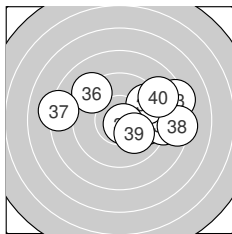

Serie 4: 92.2 (88)

9.8 →	9.0 →	8.3 →	9.6 ↗	10.7* ↘
9.2 ↘	8.2 ←	8.4 →	10.1 ↘	8.9 ↗

beste Teiler: 59.3 (35.), 217.4 (39.), 300.6 (31.)
Trefferlage: 1.98 mm rechts, 0.72 mm hoch
Streuwert: 3.18, horizontal: 4.20, vertikal: 1.61



Ergebnis: 407.1 (388)
Serien: 100.9 101.9 102.9 101.4
Zähler: 28 12 0 0 0 0 0 0 0 0
Innenzehner: 21
Weiteste: 376 (2.), 359 (12.), 350 (1.)
beste Teiler: 32.8 (5.), 43.9 (30.), 50.2 (19.)
Trefferlage: 0.63 mm links, 0.44 mm hoch
Streuwert: 1.41, horizontal: 1.52, vertikal: 1.29

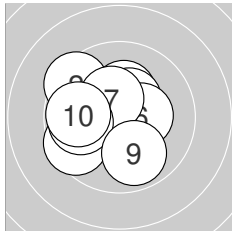
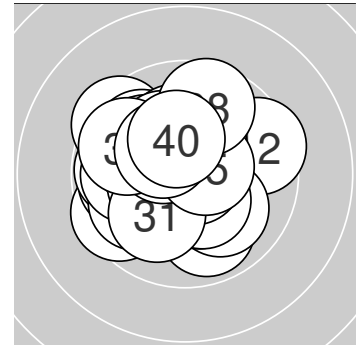

Serie 1: 100.9 (95)

9.6 ↙	9.4 ↘	10.3* ↑	10.4* ↗	10.8* ↘
10.4* →	10.4* ↖	9.9 ←	9.9 ↓	9.8 ←

beste Teiler: 32.8 (5.), 134.8 (4.), 141.0 (7.)
Trefferlage: 0.89 mm links, 0.24 mm hoch
Streuwert: 1.66, horizontal: 1.82, vertikal: 1.49

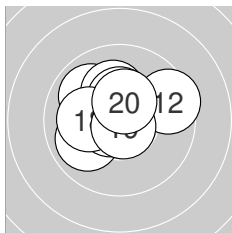

Serie 2: 101.9 (97)

9.9 ↘	9.5 →	10.2* ↑	10.4* ↑	10.0 ↙
9.9 ↙	10.7* ↖	10.1 ←	10.8* ↓	10.4* ↑

beste Teiler: 50.2 (19.), 71.1 (17.), 134.1 (20.)
Trefferlage: 0.55 mm links, 0.47 mm hoch
Streuwert: 1.47, horizontal: 1.72, vertikal: 1.17

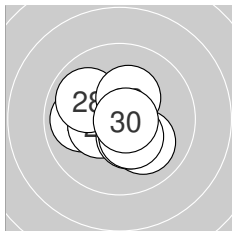

Serie 3: 102.9 (98)

10.1 ←	9.9 ←	10.0 ↘	10.4* ←	10.4* ↓
10.4* ↓	10.7* ↗	9.9 ↘	10.3* ↑	10.8* →

beste Teiler: 43.9 (30.), 56.2 (27.), 135.0 (25.)
Trefferlage: 0.36 mm links, 0.08 mm tief
Streuwert: 1.29, horizontal: 1.50, vertikal: 1.04

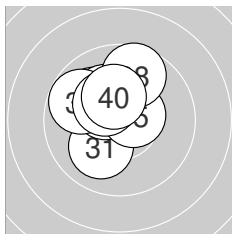

Serie 4: 101.4 (98)

10.1 ↙	10.4* ↘	10.1 ↑	10.0 ↘	10.5* →
10.2* ↘	9.8 ↘	9.7 ↑	10.3* ↘	10.3* ↑

beste Teiler: 101.2 (35.), 133.8 (32.), 152.3 (39.)
Trefferlage: 0.70 mm links, 1.16 mm hoch
Streuwert: 1.22, horizontal: 1.16, vertikal: 1.28



Ergebnis: **394.8** (377)
 Serien: 99.5 97.3 98.6 99.4
 Zähler: 22 14 3 1 0 0 0 0 0 0
 Innenzehner: 18
 Weitester: 770 (13.), 677 (9.), 622 (11.)
 beste Teiler: 30.3 (8.), 42.6 (23.), 48.7 (31.)
 Trefferlage: 0.55 mm links, 0.55 mm tief
 Streuwert: 2.27, horizontal: 2.66, vertikal: 1.80

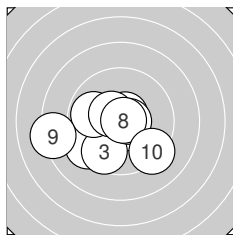
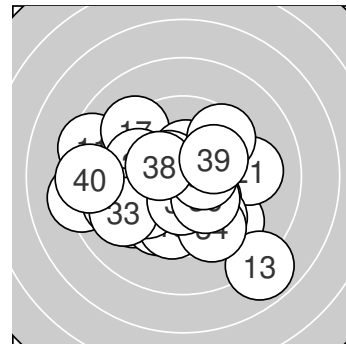

Serie 1: 99.5 (94)

9.3 ↙ 10.7* ↓ 9.6 ↘ 9.9 ← 10.6* ↗
 10.6* → 10.5* ↖ 10.8* → 8.2 ← 9.3 ↘
 beste Teiler: 30.3 (8.), 73.2 (2.), 76.8 (5.)
 Trefferlage: 1.02 mm links, 0.83 mm tief
 Streuwert: 2.17, horizontal: 2.68, vertikal: 1.49

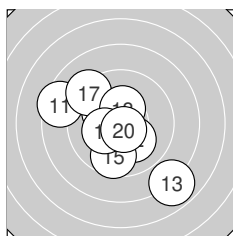

Serie 2: 97.3 (93)

8.5 ← 10.1 ↘ 7.9 ↘ 10.3* ↖ 9.7 ↓
 10.2* ↖ 9.2 ↖ 10.4* ↑ 10.3* ↙ 10.7* ↘
 beste Teiler: 68.8 (20.), 144.2 (18.), 168.2 (14.)
 Trefferlage: 0.73 mm links, 0.34 mm tief
 Streuwert: 2.76, horizontal: 2.86, vertikal: 2.66

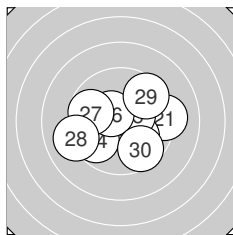

Serie 3: 98.6 (94)

9.2 → 10.1 ↘ 10.8* ↗ 9.7 ↙ 10.4* ↗
 10.5* ↖ 9.7 ← 9.1 ← 9.5 ↗ 9.6 ↘
 beste Teiler: 42.6 (23.), 117.4 (26.), 129.7 (25.)
 Trefferlage: 0.11 mm rechts, 0.23 mm tief
 Streuwert: 2.23, horizontal: 2.72, vertikal: 1.59

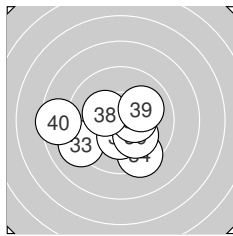

Serie 4: 99.4 (96)

10.8* ↓ 10.5* ↙ 9.1 ↙ 9.4 ↘ 10.3* ↓
 10.1 ↘ 10.4* → 10.3* ↖ 10.0 → 8.5 ←
 beste Teiler: 48.7 (31.), 123.4 (32.), 134.1 (37.)
 Trefferlage: 0.58 mm links, 0.81 mm tief
 Streuwert: 2.12, horizontal: 2.67, vertikal: 1.38



Ergebnis: 385.6 (370)
Serien: 93.3 96.5 97.1 98.7
Zähler: 17 16 7 0 0 0 0 0 0 0 0
Innenzehner: 9
Weiteste: 727 (3.), 682 (2.), 674 (28.)
beste Teiler: 132.0 (20.), 132.8 (24.), 144.5 (7.)
Trefferlage: 0.13 mm links, 0.19 mm hoch
Streuwert: 2.65, horizontal: 2.74, vertikal: 2.56

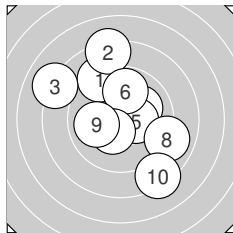
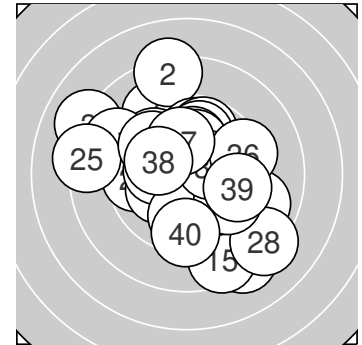

Serie 1: 93.3 (91)

9.2 ↘	8.2 ↑	8.0 ↖	10.1 ↗	10.3* →
9.8 ↑	10.4* ↙	9.0 →	10.0 ←	8.3 ↘

beste Teiler: 144.5 (7.), 152.6 (5.), 220.7 (4.)
Trefferlage: 0.07 mm links, 0.84 mm hoch
Streuwert: 3.37, horizontal: 3.24, vertikal: 3.50

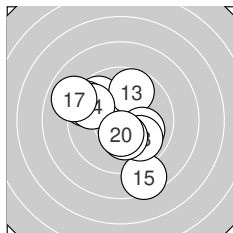

Serie 2: 96.5 (91)

9.7 ↘	9.4 ↖	9.7 ↑	9.7 ↖	8.5 ↓
10.0 →	8.9 ↖	9.9 ↘	10.3* ↓	10.4* ↓

beste Teiler: 132.0 (20.), 172.2 (19.), 233.1 (16.)
Trefferlage: 0.52 mm links, 0.12 mm tief
Streuwert: 2.57, horizontal: 2.54, vertikal: 2.60

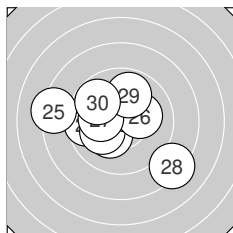

Serie 3: 97.1 (93)

9.6 ←	10.3* ↙	10.1 ←	10.4* ↑	8.3 ←
10.2* →	10.2* ←	8.3 ↘	9.9 ↑	9.8 ↘

beste Teiler: 132.8 (24.), 175.0 (22.), 196.4 (27.)
Trefferlage: 0.86 mm links, 0.04 mm hoch
Streuwert: 2.66, horizontal: 3.18, vertikal: 1.99

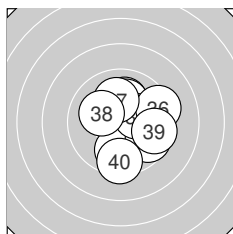

Serie 4: 98.7 (95)

9.9 ↓	9.7 ↘	10.1 ↑	10.1 ↑	10.3* →
9.4 →	10.1 ↑	10.1 ↖	9.6 →	9.4 ↓

beste Teiler: 166.4 (35.), 207.3 (34.), 207.5 (38.)
Trefferlage: 0.94 mm rechts, 0.00 mm
Streuwert: 2.01, horizontal: 1.82, vertikal: 2.18



Ergebnis: **386.7** (371)
 Serien: 98.5 93.8 95.8 98.6
 Zähler: 14 23 3 0 0 0 0 0 0 0
 Innenzehner: 10
 Weitestе: 708 (1.), 610 (17.), 509 (19.)
 beste Teiler: 107.1 (4.), 129.0 (8.), 143.7 (31.)
 Trefferlage: 0.36 mm rechts, 0.07 mm tief
 Streuwert: 2.49, horizontal: 2.61, vertikal: 2.36

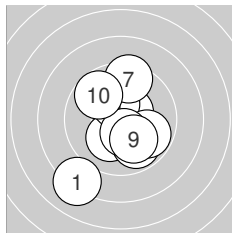
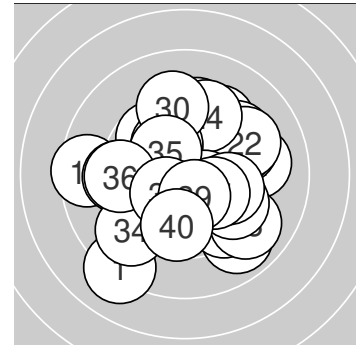

Serie 1: 98.5 (94)

8.1 ↙	10.2* ↙	9.9 ↘	10.5* ↗	10.4* ↖
9.8 ↘	9.4 ↑	10.4* ↓	10.1 ↘	9.7 ↘

beste Teiler: 107.1 (4.), 129.0 (8.), 148.3 (5.)
 Trefferlage: 0.05 mm links, 0.62 mm tief
 Streuwert: 2.36, horizontal: 1.91, vertikal: 2.73

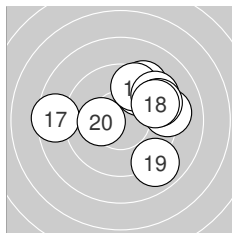

Serie 2: 93.8 (89)

9.2 →	9.4 ↗	9.7 ↗	9.6 ↗	9.4 ↗
9.4 ↗	8.5 ←	9.5 ↗	8.9 ↘	10.2* ←

beste Teiler: 181.5 (20.), 319.2 (13.), 337.8 (14.)
 Trefferlage: 1.48 mm rechts, 1.14 mm hoch
 Streuwert: 2.71, horizontal: 3.17, vertikal: 2.14

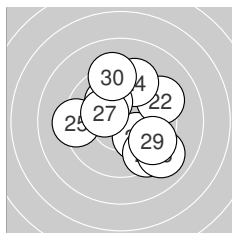

Serie 3: 95.8 (93)

10.1 ↘	9.3 ↗	9.4 ↘	9.4 ↗	9.3 ←
10.1 ↘	10.3* ↖	9.0 ↘	9.6 ↘	9.3 ↑

beste Teiler: 167.7 (27.), 205.7 (21.), 213.3 (26.)
 Trefferlage: 0.81 mm rechts, 0.29 mm hoch
 Streuwert: 2.61, horizontal: 2.61, vertikal: 2.60

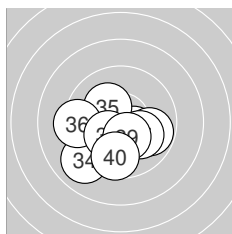

Serie 4: 98.6 (95)

10.4* ↘	9.4 ←	9.8 →	9.0 ↙	10.2* ↖
9.3 ←	10.1 ↘	10.3* ↙	10.4* ↓	9.7 ↓

beste Teiler: 143.7 (31.), 147.3 (39.), 166.8 (38.)
 Trefferlage: 0.78 mm links, 1.09 mm tief
 Streuwert: 1.97, horizontal: 2.39, vertikal: 1.42



Ergebnis: **404.4** (386)
 Serien: 100.6 102.3 99.5 102.0
 Zähler: 28 10 2 0 0 0 0 0 0 0
 Innenzehner: 20
 Weitester: 629 (25.), 599 (17.), 447 (35.)
 beste Teiler: 29.2 (8.), 39.3 (38.), 54.7 (18.)
 Trefferlage: 0.91 mm rechts, 0.19 mm hoch
 Streuwert: 1.71, horizontal: 1.72, vertikal: 1.71

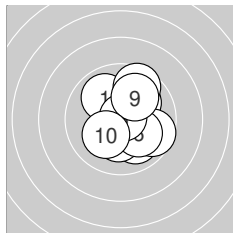
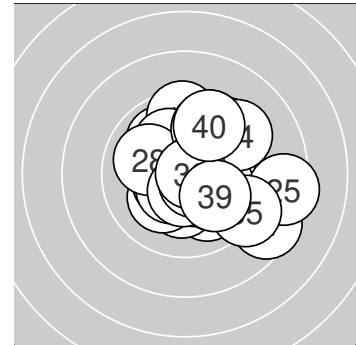

Serie 1: 100.6 (97)

9.9 ↘	10.1 ↗	10.0 ↘	10.2* ↓	9.7 ↘
10.1 ↘	9.6 ↗	10.8* ↗	10.0 ↗	10.2* ↗

beste Teiler: 29.2 (8.), 179.1 (4.), 200.8 (10.)
 Trefferlage: 0.77 mm rechts, 0.11 mm hoch
 Streuwert: 1.69, horizontal: 1.44, vertikal: 1.91

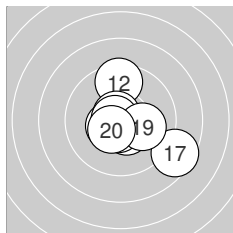

Serie 2: 102.3 (97)

10.5* ↖	9.5 ↑	10.6* ↓	10.7* ↖	10.5* ↘
10.6* ↓	8.6 ↘	10.7* ←	10.1 →	10.5* ↗

beste Teiler: 54.7 (18.), 63.4 (14.), 85.1 (16.)
 Trefferlage: 0.46 mm rechts, 0.36 mm tief
 Streuwert: 1.78, horizontal: 1.86, vertikal: 1.69

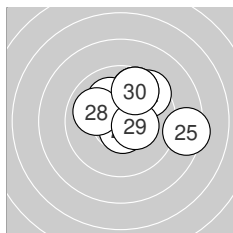

Serie 3: 99.5 (95)

10.4* ↑	9.5 ↗	10.7* ↘	9.7 ↗	8.4 →
10.6* ↓	10.1 ↘	10.0 ↖	10.4* →	9.7 ↗

beste Teiler: 73.0 (23.), 82.4 (26.), 132.1 (21.)
 Trefferlage: 1.03 mm rechts, 0.98 mm hoch
 Streuwert: 1.94, horizontal: 2.27, vertikal: 1.54

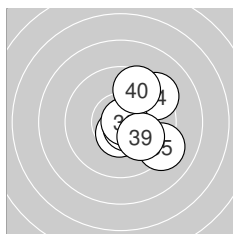

Serie 4: 102.0 (97)

10.6* ↘	10.7* →	10.6* →	9.3 ↗	9.2 ↘
10.5* ↓	10.7* ↘	10.8* →	10.0 ↘	9.6 ↗

beste Teiler: 39.3 (38.), 67.0 (32.), 75.9 (37.)
 Trefferlage: 1.37 mm rechts, 0.02 mm hoch
 Streuwert: 1.47, horizontal: 1.28, vertikal: 1.64



Ergebnis: **364.7** (345)
 Serien: 93.5 94.4 91.1 85.7
 Zähler: 9 15 10 5 0 1 0 0 0 0 0
 Innenzehner: 7
 Weitester: 1318 (33.), 941 (28.), 870 (40.)
 beste Teiler: 22.2 (18.), 57.8 (20.), 131.2 (6.)
 Trefferlage: 0.46 mm links, 0.80 mm hoch
 Streuwert: 3.79, horizontal: 4.57, vertikal: 2.79

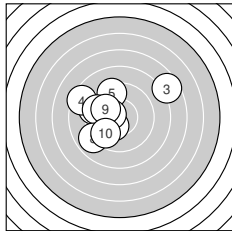
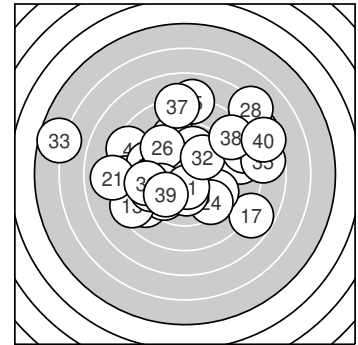

Serie 1: 93.5 (89)

10.3* ↙	9.3 ←	7.6 ↗	8.4 ↖	9.4 ↑
10.4* ↖	9.5 ↖	8.9 ↗	10.0 ↖	9.7 ↙

beste Teiler: 131.2 (6.), 155.6 (1.), 245.6 (9.)
 Trefferlage: 1.74 mm links, 0.78 mm hoch
 Streuwert: 3.03, horizontal: 3.50, vertikal: 2.48

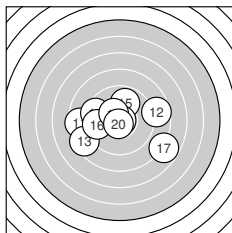

Serie 2: 94.4 (88)

8.5 ←	8.7 →	8.5 ↙	9.4 ↖	9.9 ↑
9.6 ←	7.8 ↘	10.9* →	10.4* ↖	10.7* ↙

beste Teiler: 22.2 (18.), 57.8 (20.), 139.7 (19.)
 Trefferlage: 0.62 mm links, 0.30 mm tief
 Streuwert: 3.36, horizontal: 4.28, vertikal: 2.06

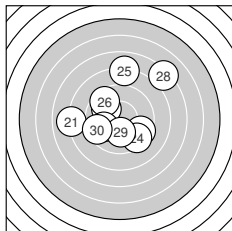

Serie 3: 91.1 (87)

8.0 ←	9.9 ↖	9.5 ↘	9.4 ↘	8.0 ↑
9.5 ↖	9.9 ↙	7.2 ↗	10.2* ↓	9.5 ↙

beste Teiler: 198.6 (29.), 254.4 (22.), 267.8 (27.)
 Trefferlage: 0.40 mm links, 0.85 mm hoch
 Streuwert: 3.80, horizontal: 3.96, vertikal: 3.64

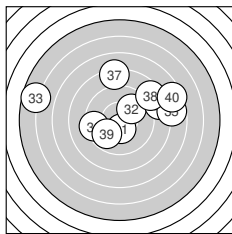

Serie 4: 85.7 (81)

10.4* ↓	10.0 ↗	5.7 ←	8.4 →	7.7 →
9.4 ←	8.2 ↑	8.6 ↗	9.8 ↙	7.5 →

beste Teiler: 133.0 (31.), 248.2 (32.), 283.6 (39.)
 Trefferlage: 0.92 mm rechts, 1.86 mm hoch
 Streuwert: 4.88, horizontal: 6.34, vertikal: 2.75



Ergebnis: 388.8 (373)
Serien: 95.3 101.6 96.5 95.4
Zähler: 19 16 4 1 0 0 0 0 0 0
Innenzehner: 13
Weiteste: 808 (25.), 739 (8.), 676 (10.)
beste Teiler: 84.0 (17.), 94.2 (18.), 113.6 (14.)
Trefferlage: 0.27 mm rechts, 0.82 mm tief
Streuwert: 2.42, horizontal: 2.88, vertikal: 1.85

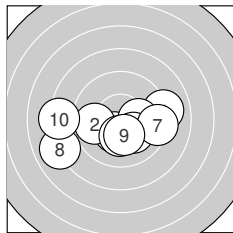
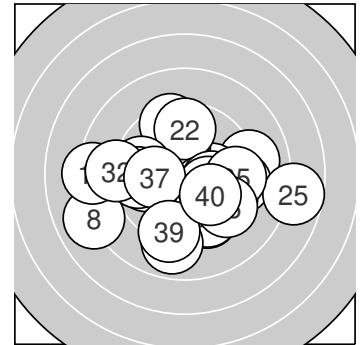

Serie 1: 95.3 (93)

10.3* ↙ 9.8 ← 10.2* ↓ 9.0 → 10.2* →
 10.1 ↘ 9.3 → 8.0 ← 10.2* ↓ 8.2 ←
beste Teiler: 158.3 (1.), 176.3 (9.), 183.3 (3.)
Trefferlage: 0.45 mm links, 0.97 mm tief
Streuwert: 2.92, horizontal: 3.96, vertikal: 1.20

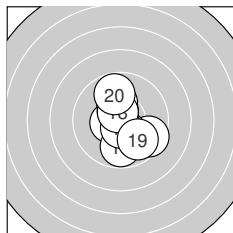

Serie 2: 101.6 (96)

9.5 ↘ 10.5* ← 10.3* ↓ 10.5* ↑ 9.8 ↓
 10.2* ↑ 10.6* ↓ 10.6* ↑ 9.8 ↘ 9.8 ↑
beste Teiler: 84.0 (17.), 94.2 (18.), 113.6 (14.)
Trefferlage: 0.28 mm rechts, 0.24 mm tief
Streuwert: 1.60, horizontal: 1.28, vertikal: 1.87

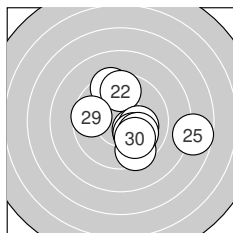

Serie 3: 96.5 (93)

9.4 ↑ 9.6 ↑ 9.5 ↓ 10.3* ↘ 7.7 →
 10.1 → 10.2* ↘ 10.0 ↘ 9.7 ← 10.0 ↘
beste Teiler: 159.7 (24.), 193.1 (27.), 201.9 (26.)
Trefferlage: 1.34 mm rechts, 0.30 mm tief
Streuwert: 2.54, horizontal: 2.84, vertikal: 2.20

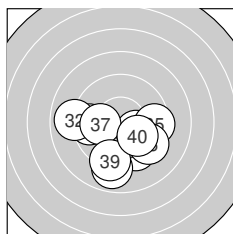

Serie 4: 95.4 (91)

9.6 ← 8.9 ← 9.6 ↓ 10.2* ↘ 9.5 →
 9.4 ↘ 10.1 ← 8.9 ↓ 9.2 ↓ 10.0 ↘
beste Teiler: 193.8 (34.), 223.0 (37.), 238.9 (40.)
Trefferlage: 0.08 mm links, 1.76 mm tief
Streuwert: 2.44, horizontal: 2.91, vertikal: 1.84



Ergebnis: **397.5** (376)
 Serien: 96.0 101.6 99.1 100.8
 Zähler: 20 16 4 0 0 0 0 0 0 0
 Innenzehner: 17
 Weitester: 685 (4.), 579 (22.), 573 (5.)
 beste Teiler: 47.2 (17.), 68.8 (21.), 74.4 (12.)
 Trefferlage: 0.31 mm rechts, 0.12 mm hoch
 Streuwert: 2.12, horizontal: 2.70, vertikal: 1.31

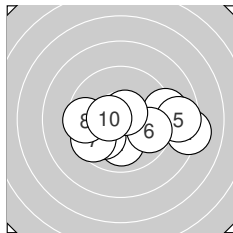
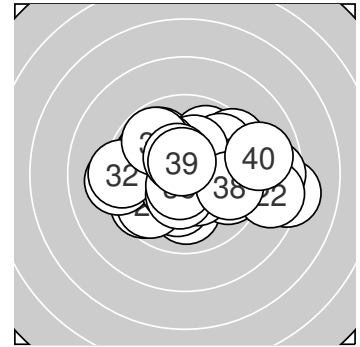

Serie 1: 96.0 (92)

10.0 ↓	9.1 →	10.0 ↘	8.2 →	8.7 →
9.7 ↘	9.6 ↘	9.6 ←	10.6* ↗	10.5* ←

beste Teiler: 77.1 (9.), 114.4 (10.), 238.1 (1.)
 Trefferlage: 1.12 mm rechts, 0.69 mm tief
 Streuwert: 2.68, horizontal: 3.61, vertikal: 1.13

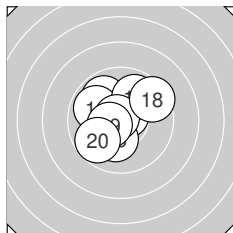

Serie 2: 101.6 (95)

10.5* ↑	10.7* ↗	9.9 ↘	9.9 ↘	10.2* ↓
9.9 ↗	10.8* ↘	9.5 ↗	10.5* ←	9.7 ↘

beste Teiler: 47.2 (17.), 74.4 (12.), 118.7 (19.)
 Trefferlage: 0.33 mm links, 0.53 mm hoch
 Streuwert: 1.64, horizontal: 1.71, vertikal: 1.57

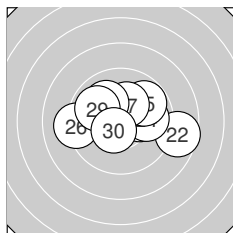

Serie 3: 99.1 (94)

10.7* ↑	8.6 →	10.2* →	9.9 →	9.8 ↗
9.2 ←	10.3* ↗	10.0 ↘	9.9 ↘	10.5* ↘

beste Teiler: 68.8 (21.), 113.6 (30.), 175.2 (27.)
 Trefferlage: 0.40 mm rechts, 0.49 mm hoch
 Streuwert: 2.17, horizontal: 2.85, vertikal: 1.13

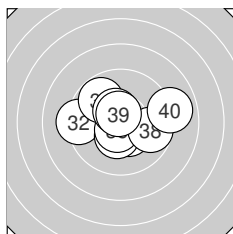

Serie 4: 100.8 (95)

10.6* ↘	9.3 ←	10.4* ↘	10.4* ↓	10.6* ↓
9.8 ↘	10.5* ↗	9.7 →	10.6* ↗	8.9 →

beste Teiler: 82.3 (35.), 84.4 (39.), 87.8 (31.)
 Trefferlage: 0.05 mm rechts, 0.18 mm hoch
 Streuwert: 1.94, horizontal: 2.48, vertikal: 1.17



LG 40 ZR
StandNr: 63
Innreiter, Eva #480

Senioren_1w
Wertung

StartNr: 55
22.03.2024 10:23
OÖ – SV Molln

Ergebnis: **0.0** (0)_{DNS}
Serien:
Zähler: 0 0 0 0 0 0 0 0 0 0 0
Innenzehner: 0
Weiteste:
~~beste Teiler~~Schütze ist nicht zum Wettkampf angetreten
Trefferlage: 0.00 mm , 0.00 mm
Streuwert:

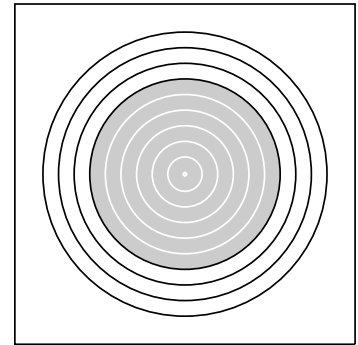

Ergebnis: **400.5** (381)
 Serien: 101.0 99.6 100.0 99.9
 Zähler: 24 14 1 1 0 0 0 0 0 0
 Innenzehner: 17
 Weitester: 768 (14.), 591 (6.), 356 (28.)
 beste Teiler: 16.4 (5.), 40.4 (18.), 72.3 (37.)
 Trefferlage: 0.22 mm links, 0.37 mm hoch
 Streuwert: 1.93, horizontal: 2.39, vertikal: 1.31

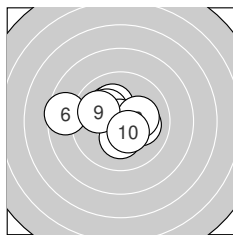
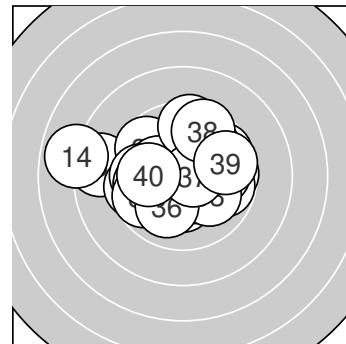

Serie 1: 101.0 (97)

10.1 →	10.2* ↘	10.2* ↘	10.2* ↘	10.9* ↘
8.6 ←	10.3* ↓	10.2* →	9.9 ↖	10.4* ↘

beste Teiler: 16.4 (5.), 136.8 (10.), 173.0 (7.)
 Trefferlage: 0.71 mm links, 0.35 mm hoch
 Streuwert: 1.81, horizontal: 2.29, vertikal: 1.13

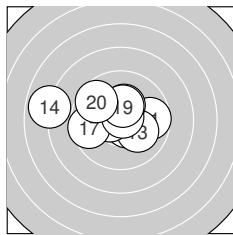

Serie 2: 99.6 (94)

9.7 →	10.6* ↘	10.1 ↘	7.9 ←	10.5* ←
10.3* ↑	9.6 ←	10.8* ↗	10.4* ↑	9.7 ↘

beste Teiler: 40.4 (18.), 94.1 (12.), 114.1 (15.)
 Trefferlage: 0.82 mm links, 0.43 mm hoch
 Streuwert: 2.29, horizontal: 3.04, vertikal: 1.12

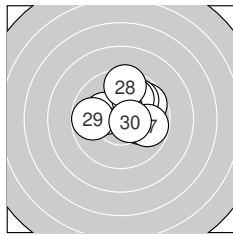

Serie 3: 100.0 (95)

9.7 ↗	10.1 →	9.9 ↗	10.5* ↘	10.2* ←
10.0 ↗	9.8 →	9.5 ↑	9.8 ←	10.5* →

beste Teiler: 103.5 (30.), 106.0 (24.), 182.1 (25.)
 Trefferlage: 0.67 mm rechts, 0.93 mm hoch
 Streuwert: 1.67, horizontal: 1.93, vertikal: 1.35

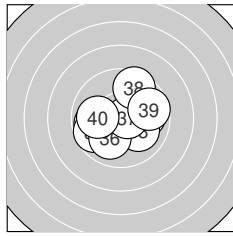

Serie 4: 99.9 (95)

9.9 →	10.4* ↙	10.0 ↘	9.9 ←	9.7 ←
10.0 ↙	10.7* →	9.6 ↑	9.7 →	10.0 ←

beste Teiler: 72.3 (37.), 143.1 (32.), 228.0 (33.)
 Trefferlage: 0.02 mm links, 0.20 mm tief
 Streuwert: 1.90, horizontal: 2.22, vertikal: 1.51



Ergebnis: **394.7** (376)
 Serien: 97.7 98.3 101.1 97.6
 Zähler: 21 14 5 0 0 0 0 0 0 0
 Innenzehner: 14
 Weitester: 580 (16.), 562 (15.), 539 (17.)
 beste Teiler: 10.6 (18.), 17.0 (14.), 66.7 (30.)
 Trefferlage: 0.14 mm rechts, 1.27 mm tief
 Streuwert: 2.04, horizontal: 2.06, vertikal: 2.01

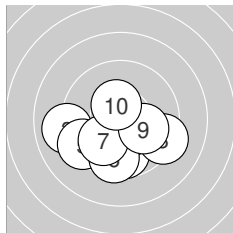
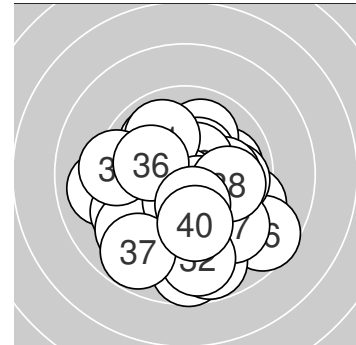

Serie 1: 97.7 (94)

9.9 ↘ 9.7 ↓ 9.0 ← 10.4* ↓ 9.3 ↙
 9.6 ↓ 10.0 ↗ 9.3 ↘ 10.1 → 10.4* ↑

beste Teiler: 129.7 (4.), 133.8 (10.), 221.5 (9.)
 Trefferlage: 0.16 mm links, 1.52 mm tief
 Streuwert: 2.07, horizontal: 2.61, vertikal: 1.32

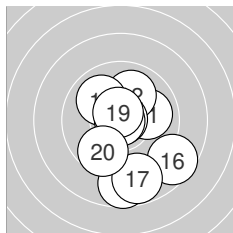

Serie 2: 98.3 (93)

10.0 → 10.0 ↑ 10.0 ↘ 10.9* ↗ 8.7 ↓
 8.6 ↘ 8.8 ↓ 10.9* ↗ 10.7* ↑ 9.7 ↗

beste Teiler: 10.6 (18.), 17.0 (14.), 72.7 (19.)
 Trefferlage: 0.61 mm rechts, 1.18 mm tief
 Streuwert: 2.42, horizontal: 1.88, vertikal: 2.85

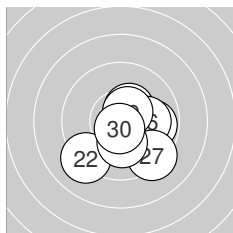

Serie 3: 101.1 (97)

10.4* ↓ 9.1 ↗ 10.4* ↗ 10.7* ↓ 9.8 →
 10.0 → 9.3 ↘ 10.2* ↓ 10.5* ↗ 10.7* ↓

beste Teiler: 66.7 (30.), 68.2 (24.), 104.2 (29.)
 Trefferlage: 0.66 mm rechts, 0.93 mm tief
 Streuwert: 1.61, horizontal: 1.73, vertikal: 1.48

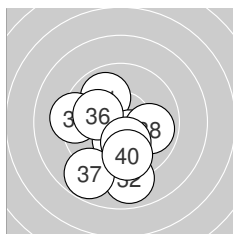

Serie 4: 97.6 (92)

9.9 ↘ 8.9 ↓ 10.3* ↓ 9.3 ← 10.4* ↓
 10.1 ← 8.8 ↗ 9.9 → 10.2* ↓ 9.8 ↓

beste Teiler: 139.7 (35.), 163.4 (33.), 185.7 (39.)
 Trefferlage: 0.53 mm links, 1.44 mm tief
 Streuwert: 2.14, horizontal: 1.99, vertikal: 2.27



Ergebnis: **396.3** (377)
 Serien: 99.5 102.3 95.7 98.8
 Zähler: 18 21 1 0 0 0 0 0 0 0
 Innenzehner: 13
 Weitesten: 568 (27.), 474 (36.), 428 (39.)
 beste Teiler: 28.3 (32.), 54.3 (17.), 54.4 (8.)
 Trefferlage: 0.26 mm links, 0.21 mm hoch
 Streuwert: 2.04, horizontal: 2.24, vertikal: 1.82

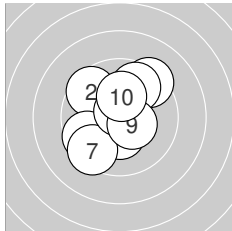
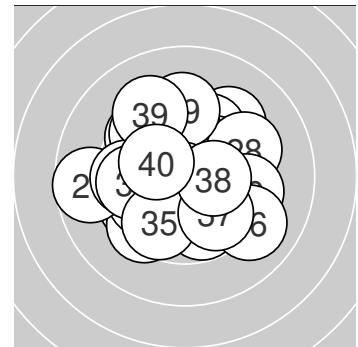

Serie 1: 99.5 (95)

10.3* ↘	9.6 ↘	10.3* ↓	9.3 ↗	9.7 ↗
9.6 ↙	9.4 ↙	10.7* ↑	10.4* ↘	10.2* ↑

beste Teiler: 54.4 (8.), 128.0 (9.), 153.0 (3.)
 Trefferlage: 0.39 mm links, 0.44 mm hoch
 Streuwert: 1.97, horizontal: 1.86, vertikal: 2.07

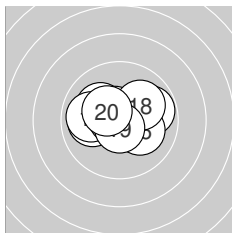

Serie 2: 102.3 (98)

10.0 ←	9.8 →	10.1 ↘	9.9 ←	10.6* ↘
10.1 →	10.7* ←	10.0 ↗	10.7* ↓	10.4* ↘

beste Teiler: 54.3 (17.), 69.0 (19.), 89.9 (15.)
 Trefferlage: 0.24 mm links, 0.36 mm hoch
 Streuwert: 1.40, horizontal: 1.84, vertikal: 0.75

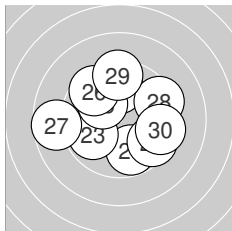

Serie 3: 95.7 (90)

9.8 ↓	9.5 ↘	9.9 ↙	9.9 ↑	10.1 ↘
9.6 ↘	8.7 ←	9.4 →	9.4 ↑	9.4 →

beste Teiler: 205.3 (25.), 272.1 (24.), 274.6 (23.)
 Trefferlage: 0.09 mm links, 0.45 mm hoch
 Streuwert: 2.66, horizontal: 2.99, vertikal: 2.27

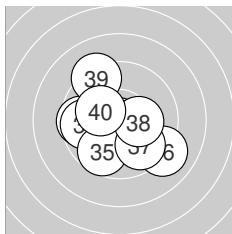

Serie 4: 98.8 (94)

9.6 ←	10.8* ↙	10.4* →	9.7 ←	9.7 ↙
9.1 ↘	9.8 ↘	10.3* →	9.2 ↘	10.2* ↘

beste Teiler: 28.3 (32.), 146.6 (33.), 171.4 (38.)
 Trefferlage: 0.31 mm links, 0.42 mm tief
 Streuwert: 2.19, horizontal: 2.42, vertikal: 1.93



Ergebnis: **378.0** (360)
 Serien: 93.7 94.7 96.7 92.9
 Zähler: 13 16 9 2 0 0 0 0 0 0
 Innenzehner: 11
 Weitester: 916 (40.), 781 (31.), 731 (9.)
 beste Teiler: 13.0 (38.), 33.3 (17.), 72.0 (30.)
 Trefferlage: 0.22 mm rechts, 0.19 mm tief
 Streuwert: 3.09, horizontal: 3.69, vertikal: 2.33

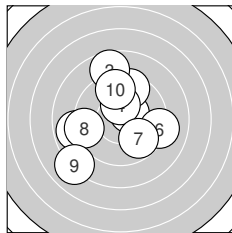
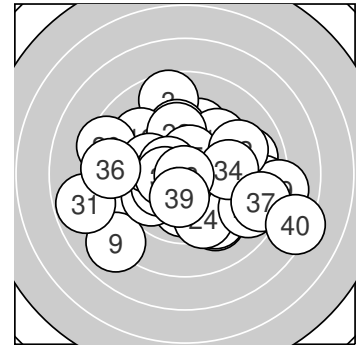

Serie 1: 93.7 (89)

10.5* ↗	9.5 ↑	8.7 ↑	10.3* ↑	8.9 ←
9.1 →	9.8 ↘	9.3 ←	8.0 ↖	9.6 ↑

beste Teiler: 120.9 (1.), 163.0 (4.), 296.4 (7.)
 Trefferlage: 0.78 mm links, 0.41 mm hoch
 Streuwert: 3.18, horizontal: 3.18, vertikal: 3.18

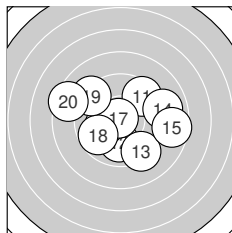

Serie 2: 94.7 (91)

9.5 ↗	10.0 ↓	9.3 ↘	9.0 →	8.6 →
10.2* ←	10.8* ↖	9.7 ↖	9.2 ↖	8.4 ↖

beste Teiler: 33.3 (17.), 184.4 (16.), 248.5 (12.)
 Trefferlage: 0.13 mm rechts, 0.00 mm
 Streuwert: 3.04, horizontal: 3.70, vertikal: 2.19

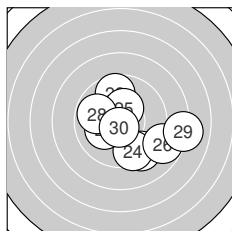

Serie 3: 96.7 (92)

10.3* ↑	9.7 ↑	9.3 ↘	9.5 ↓	10.4* ↑
8.8 →	10.1 ←	9.8 ←	8.1 →	10.7* ↓

beste Teiler: 72.0 (30.), 149.4 (25.), 173.5 (21.)
 Trefferlage: 1.04 mm rechts, 0.49 mm tief
 Streuwert: 2.64, horizontal: 2.99, vertikal: 2.24

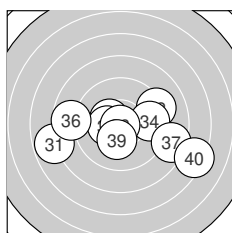

Serie 4: 92.9 (88)

7.8 ←	9.2 →	10.4* ↖	9.6 →	10.3* ←
8.7 ←	8.5 →	10.9* ↖	10.2* ↓	7.3 →

beste Teiler: 13.0 (38.), 140.0 (33.), 153.0 (35.)
 Trefferlage: 0.50 mm rechts, 0.69 mm tief
 Streuwert: 3.69, horizontal: 4.93, vertikal: 1.70



Ergebnis: 376.7 (356)
Serien: 91.8 93.7 92.0 99.2
Zähler: 8 20 12 0 0 0 0 0 0 0
Innenzehner: 4
Weiteste: 667 (38.), 654 (20.), 646 (2.)
beste Teiler: 37.0 (31.), 65.7 (32.), 149.0 (34.)
Trefferlage: 0.21 mm rechts, 0.61 mm tief
Streuwert: 2.93, horizontal: 3.45, vertikal: 2.30

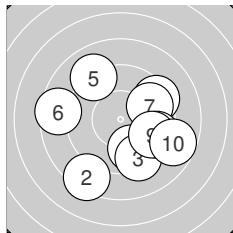
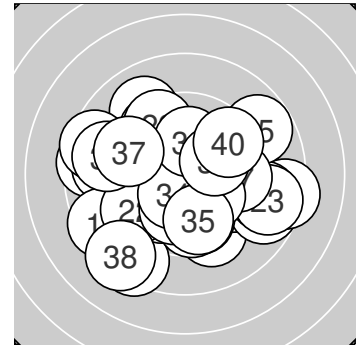

Serie 1: 91.8 (87)

9.8 ↘	8.4 ↙	9.3 ↘	9.4 ↗	9.0 ↖
8.5 ←	9.7 ↗	9.4 →	9.6 →	8.7 →

beste Teiler: 297.3 (1.), 308.3 (7.), 336.3 (9.)
Trefferlage: 0.86 mm rechts, 0.92 mm tief
Streuwert: 3.27, horizontal: 3.60, vertikal: 2.90

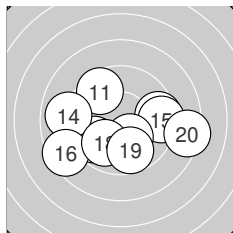

Serie 2: 93.7 (88)

9.6 ↖	9.7 ↙	9.5 →	8.9 ←	9.4 →
8.5 ↙	10.2* ↘	9.9 ↙	9.7 ↘	8.3 →

beste Teiler: 185.7 (17.), 265.1 (18.), 304.5 (19.)
Trefferlage: 0.05 mm links, 0.91 mm tief
Streuwert: 3.06, horizontal: 3.91, vertikal: 1.85

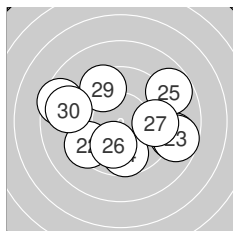

Serie 3: 92.0 (86)

8.9 →	9.4 ↙	8.7 →	9.7 ↘	8.8 ↗
10.0 ↘	9.6 →	8.5 ←	9.5 ↖	8.9 ←

beste Teiler: 237.2 (26.), 313.1 (24.), 334.5 (27.)
Trefferlage: 0.24 mm rechts, 0.18 mm tief
Streuwert: 3.38, horizontal: 4.19, vertikal: 2.29

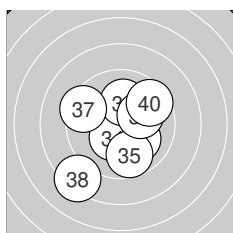

Serie 4: 99.2 (95)

10.8* ↑	10.7* ↙	10.1 ↘	10.4* ↙	9.7 ↘
10.1 ↑	9.4 ↖	8.3 ↙	10.1 →	9.6 ↗

beste Teiler: 37.0 (31.), 65.7 (32.), 149.0 (34.)
Trefferlage: 0.16 mm links, 0.42 mm tief
Streuwert: 2.30, horizontal: 2.25, vertikal: 2.34

