

Ergebnis: **419.4** (399)
 Serien: 104.6 105.6 103.7 105.5
 Zähler: 39 1 0 0 0 0 0 0 0 0
 Innenzehner: 34
 Weitestе: 360 (10.), 235 (22.), 224 (24.)
 beste Teiler: 23.3 (18.), 31.0 (3.), 32.5 (23.)
 Trefferlage: 0.21 mm rechts, 0.31 mm tief
 Streuwert: 0.94, horizontal: 1.02, vertikal: 0.85

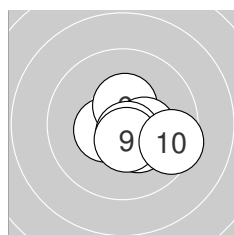
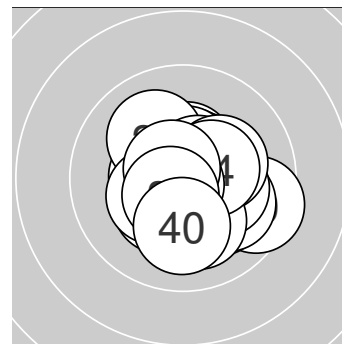

Serie 1: 104.6 (99)

10.3* ↘	10.8* ↓	10.8* ↓	10.8* ↘	10.5* ←
10.4* ↑	10.3* →	10.7* ↘	10.5* ↓	9.5* ↘

beste Teiler: 31.0 (3.), 38.9 (4.), 41.7 (2.)
 Trefferlage: 0.58 mm rechts, 0.45 mm tief
 Streuwert: 0.99, horizontal: 1.21, vertikal: 0.71

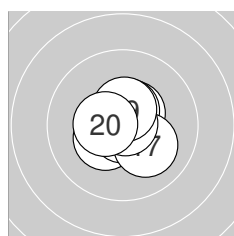

Serie 2: 105.6 (100)

10.8* ↘	10.6* ↗	10.4* ↗	10.8* ↓	10.5* ↗
10.5* ↑	10.1* ↘	10.9* ↗	10.5* ↑	10.5* ←

beste Teiler: 23.3 (18.), 32.6 (11.), 38.0 (14.)
 Trefferlage: 0.02 mm rechts, 0.04 mm tief
 Streuwert: 0.84, horizontal: 0.84, vertikal: 0.83

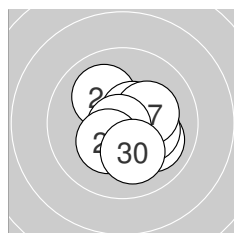

Serie 3: 103.7 (100)

10.6* ↓	10.0* ↘	10.8* ↘	10.1* ↘	10.2* →
10.6* ↗	10.2* ↗	10.8* ↗	10.3* ↗	10.1* ↓

beste Teiler: 32.5 (23.), 36.0 (28.), 77.9 (21.)
 Trefferlage: 0.46 mm rechts, 0.29 mm tief
 Streuwert: 1.13, horizontal: 1.14, vertikal: 1.11

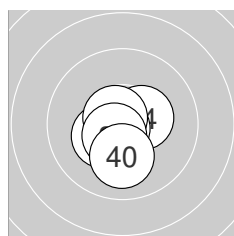

Serie 4: 105.5 (100)

10.7* →	10.7* ↓	10.6* ↗	10.4* →	10.8* ↗
10.6* ←	10.3* ↗	10.7* ↘	10.6* ↗	10.1* ↓

beste Teiler: 45.3 (35.), 55.5 (32.), 61.0 (31.)
 Trefferlage: 0.22 mm links, 0.46 mm tief
 Streuwert: 0.75, horizontal: 0.74, vertikal: 0.76



Ergebnis: 404.5 (388)
Serien: 102.8 103.5 97.3 100.9
Zähler: 31 8 0 0 1 0 0 0 0 0
Innenzehner: 25
Weiteste: 1225 (22.), 425 (27.), 415 (25.)
beste Teiler: 22.1 (13.), 48.0 (11.), 55.0 (1.)
Trefferlage: 0.24 mm links, 0.64 mm tief
Streuwert: 1.96, horizontal: 1.64, vertikal: 2.24

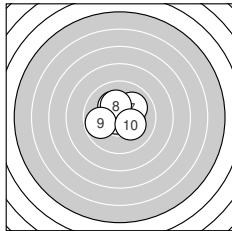
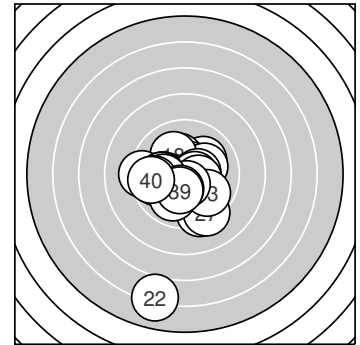

Serie 1: 102.8 (99)

10.7* ←	10.4* →	10.2* ↘	10.4* ↗	10.2* ↗
10.6* ↑	10.1 ↗	10.2* ↑	9.8 ←	10.2* ↘

beste Teiler: 55.0 (1.), 100.4 (6.), 143.9 (4.)
Trefferlage: 0.23 mm rechts, 0.53 mm hoch
Streuwert: 1.27, horizontal: 1.47, vertikal: 1.03

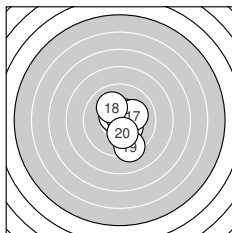

Serie 2: 103.5 (99)

10.8* →	10.5* ↗	10.9* ↑	10.3* ↘	10.6* ↘
10.7* ↑	10.1 ↗	10.1 ↘	9.3 ↓	10.2* ↓

beste Teiler: 22.1 (13.), 48.0 (11.), 64.2 (16.)
Trefferlage: 0.44 mm rechts, 0.18 mm tief
Streuwert: 1.32, horizontal: 0.92, vertikal: 1.62

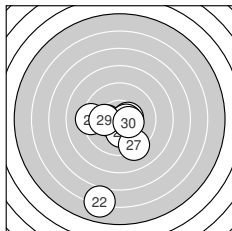

Serie 3: 97.3 (94)

10.6* ↓	6.1 ↓	10.5* →	10.2* ←	9.3 ←
10.2* ↓	9.3 ↘	10.6* →	10.1 ←	10.4* →

beste Teiler: 84.5 (21.), 95.2 (28.), 122.6 (23.)
Trefferlage: 0.57 mm links, 1.87 mm tief
Streuwert: 3.02, horizontal: 2.09, vertikal: 3.72

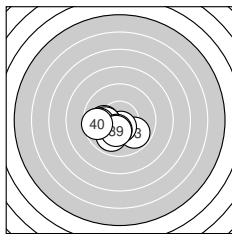

Serie 4: 100.9 (96)

10.4* ↓	9.9 ↓	9.8 ↘	10.6* ↓	10.1 ←
10.1 ←	9.7 ←	10.4* ↓	10.3* ↓	9.6 ←

beste Teiler: 97.8 (34.), 136.4 (31.), 146.7 (38.)
Trefferlage: 1.10 mm links, 1.06 mm tief
Streuwert: 1.25, horizontal: 1.62, vertikal: 0.70



Ergebnis: 418.4 (400)
Serien: 105.2 105.1 104.0 104.1
Zähler: 40 0 0 0 0 0 0 0 0 0 0
Innenzehner: 34
Weiteste: 244 (4.), 238 (3.), 229 (37.)
beste Teiler: 13.0 (15.), 44.0 (1.), 44.6 (31.)
Trefferlage: 0.23 mm rechts, 0.20 mm hoch
Streuwert: 0.96, horizontal: 0.81, vertikal: 1.08

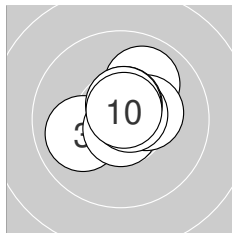
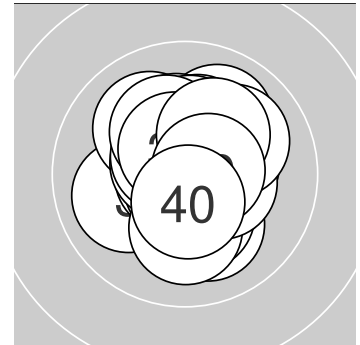

Serie 1: 105.2 (100)

10.8* ↓	10.8* ↙	10.0 ↖	10.0 ↗	10.7* ↓
10.3* →	10.7* ↘	10.6* ↑	10.6* ↑	10.7* ↑

beste Teiler: 44.0 (1.), 45.6 (2.), 56.0 (5.)
Trefferlage: 0.12 mm rechts, 0.30 mm hoch
Streuwert: 0.94, horizontal: 1.01, vertikal: 0.87

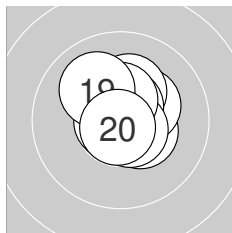

Serie 2: 105.1 (100)

10.4* ↘	10.3* ↗	10.3* ↑	10.7* ←	10.9* ↘
10.6* ↑	10.6* ↘	10.5* ↑	10.0 ↘	10.8* ↙

beste Teiler: 13.0 (15.), 45.6 (20.), 53.4 (14.)
Trefferlage: 0.18 mm rechts, 0.46 mm hoch
Streuwert: 0.86, horizontal: 0.80, vertikal: 0.92

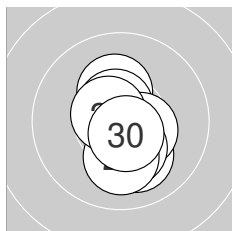

Serie 3: 104.0 (100)

10.5* ↓	10.2* ↑	10.6* ↖	10.6* ↓	10.1 ↓
10.4* ↘	10.3* ↓	10.1 ↓	10.6* ↘	10.6* ↓

beste Teiler: 80.6 (30.), 82.8 (24.), 83.3 (29.)
Trefferlage: 0.21 mm rechts, 0.57 mm tief
Streuwert: 0.97, horizontal: 0.58, vertikal: 1.24

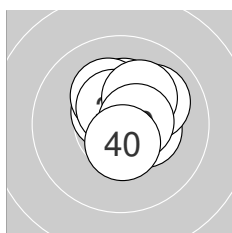

Serie 4: 104.1 (100)

10.8* ↘	10.3* ↑	10.4* →	10.6* ↖	10.2* ↖
10.5* ↖	10.0 ↗	10.2* ↗	10.6* →	10.5* ↓

beste Teiler: 44.6 (31.), 93.2 (39.), 99.7 (34.)
Trefferlage: 0.41 mm rechts, 0.63 mm hoch
Streuwert: 0.94, horizontal: 0.90, vertikal: 0.97



Ergebnis: **418.3** (399)
 Serien: 104.1 105.4 104.2 104.6
 Zähler: 39 1 0 0 0 0 0 0 0 0
 Innenzehner: 34
 Weitesten: 426 (2.), 245 (31.), 241 (23.)
 beste Teiler: 7.2 (37.), 26.0 (25.), 27.8 (5.)
 Trefferlage: 0.27 mm links, 0.29 mm hoch
 Streuwert: 1.02, horizontal: 1.14, vertikal: 0.89

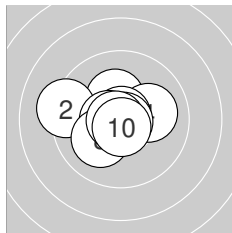
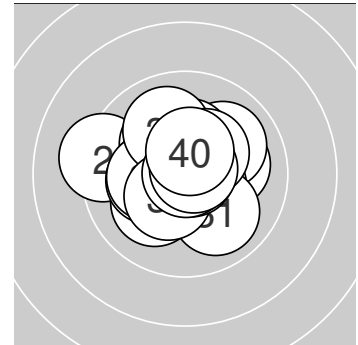

Serie 1: 104.1 (99)

10.3* ↑	9.2 ←	10.7* ←	10.1 →	10.8* ↑
10.8* ↘	10.6* ←	10.1 ↗	10.8* ←	10.7* ↓

beste Teiler: 27.8 (5.), 28.4 (6.), 40.0 (9.)
 Trefferlage: 0.55 mm links, 0.05 mm hoch
 Streuwert: 1.27, horizontal: 1.59, vertikal: 0.82

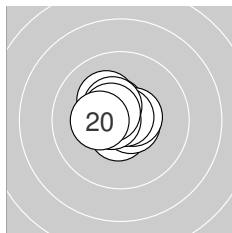

Serie 2: 105.4 (100)

10.6* ↓	10.5* ↑	10.6* ↘	10.2* ↖	10.6* →
10.8* ↗	10.5* ↑	10.7* ←	10.6* ↖	10.3* ←

beste Teiler: 38.4 (16.), 69.0 (18.), 83.5 (13.)
 Trefferlage: 0.32 mm links, 0.35 mm hoch
 Streuwert: 0.76, horizontal: 0.81, vertikal: 0.71

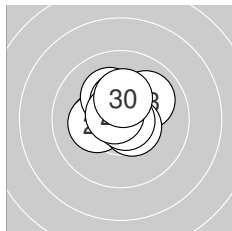

Serie 3: 104.2 (100)

10.3* ←	10.2* ←	10.0 ↗	10.5* ↘	10.8* ↑
10.8* ↘	10.2* ↑	10.4* ↑	10.7* ↖	10.3* ↑

beste Teiler: 26.0 (25.), 40.4 (26.), 57.6 (29.)
 Trefferlage: 0.14 mm links, 0.55 mm hoch
 Streuwert: 1.00, horizontal: 1.11, vertikal: 0.88

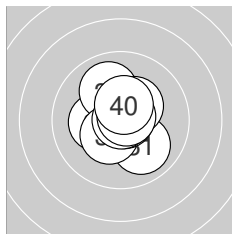

Serie 4: 104.6 (100)

10.0 ↘	10.6* ←	10.3* ←	10.0 ↖	10.4* ↗
10.8* →	10.9* ↗	10.4* ↗	10.7* ↗	10.5* ↑

beste Teiler: 7.2 (37.), 31.7 (36.), 51.6 (39.)
 Trefferlage: 0.06 mm links, 0.19 mm hoch
 Streuwert: 1.09, horizontal: 1.00, vertikal: 1.16



Ergebnis: 422.2 (397)
Serien: 104.7 106.2 105.5 105.8
Zähler: 37 3 0 0 0 0 0 0 0 0 0
Innenzehner: 37
Weiteste: 316 (6.), 269 (31.), 266 (28.)
beste Teiler: 16.2 (24.), 17.8 (30.), 29.5 (19.)
Trefferlage: 0.02 mm rechts, 0.29 mm tief
Streuwert: 0.83, horizontal: 0.89, vertikal: 0.77

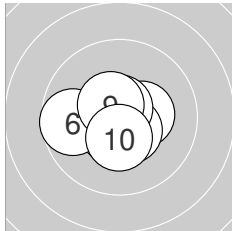
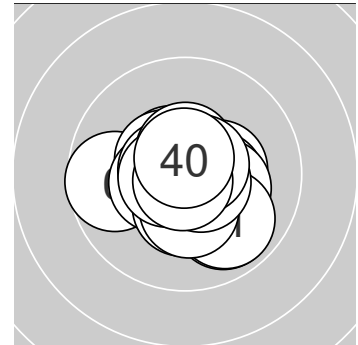

Serie 1: 104.7 (99)

10.4* →	10.7* ↘	10.7* ←	10.5* ↓	10.6* ↓
9.7 ←	10.5* ↘	10.7* ↑	10.5* ↘	10.4* ↓

beste Teiler: 58.5 (2.), 61.0 (8.), 67.4 (3.)
Trefferlage: 0.32 mm links, 0.23 mm tief
Streuwert: 0.99, horizontal: 1.18, vertikal: 0.75

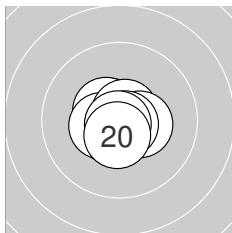

Serie 2: 106.2 (100)

10.6* ↘	10.6* ↓	10.5* ↘	10.5* ←	10.8* ↓
10.7* ↗	10.4* →	10.8* ↘	10.8* ↓	10.5* ↓

beste Teiler: 29.5 (19.), 36.0 (15.), 45.8 (18.)
Trefferlage: 0.15 mm links, 0.15 mm tief
Streuwert: 0.65, horizontal: 0.73, vertikal: 0.56

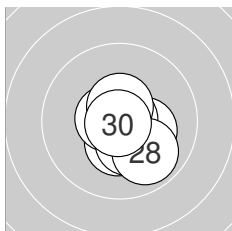

Serie 3: 105.5 (99)

10.4* ↓	10.3* ↘	10.8* ↘	10.9* ↑	10.6* ←
10.3* ↓	10.8* ↗	9.9 ↘	10.6* ↑	10.9* ↓

beste Teiler: 16.2 (24.), 17.8 (30.), 34.7 (27.)
Trefferlage: 0.29 mm rechts, 0.38 mm tief
Streuwert: 0.89, horizontal: 0.81, vertikal: 0.97

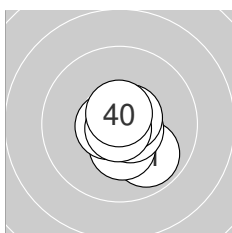

Serie 4: 105.8 (99)

9.9 ↘	10.8* ↘	10.7* ↘	10.3* ↓	10.8* ←
10.6* ↘	10.6* ←	10.6* ↗	10.8* ↓	10.7* ↑

beste Teiler: 30.6 (39.), 39.0 (35.), 39.5 (32.)
Trefferlage: 0.28 mm rechts, 0.39 mm tief
Streuwert: 0.77, horizontal: 0.70, vertikal: 0.83



Ergebnis: **416.2** (396)
 Serien: 103.9 104.5 102.8 105.0
 Zähler: 36 4 0 0 0 0 0 0 0 0
 Innenzehner: 30
 Weitestе: 310 (30.), 308 (7.), 290 (26.)
 beste Teiler: 12.2 (16.), 25.2 (34.), 26.0 (3.)
 Trefferlage: 0.13 mm rechts, 0.03 mm hoch
 Streuwert: 1.14, horizontal: 1.32, vertikal: 0.91

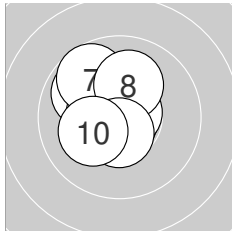
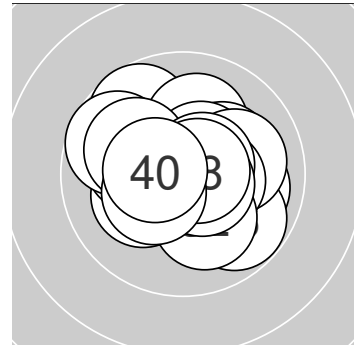

Serie 1: 103.9 (98)

10.6* ↙	10.8* ↘	10.8* ↑	10.7* ↗	9.9 ↖
10.5* ←	9.7 ↘	10.1 ↑	10.6* ↓	10.2* ↗

beste Teiler: 26.0 (3.), 31.1 (2.), 58.8 (4.)
 Trefferlage: 0.61 mm links, 0.41 mm hoch
 Streuwert: 1.14, horizontal: 1.03, vertikal: 1.23

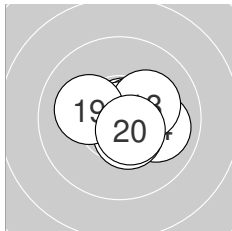

Serie 2: 104.5 (100)

10.2* →	10.7* ↘	10.8* ↗	10.0 →	10.6* ↗
10.9* ↗	10.5* ↘	10.2* ↗	10.1 ←	10.5* ↘

beste Teiler: 12.2 (16.), 41.6 (13.), 66.3 (12.)
 Trefferlage: 0.68 mm rechts, 0.06 mm tief
 Streuwert: 0.95, horizontal: 1.19, vertikal: 0.62

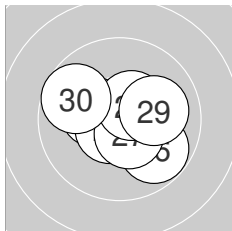

Serie 3: 102.8 (98)

10.3* ←	10.4* →	10.3* →	10.7* →	10.6* ↗
9.8 ↘	10.5* ↘	10.5* ↗	10.0 →	9.7 ↖

beste Teiler: 64.6 (24.), 87.6 (25.), 112.8 (27.)
 Trefferlage: 0.45 mm rechts, 0.02 mm tief
 Streuwert: 1.35, horizontal: 1.66, vertikal: 0.95

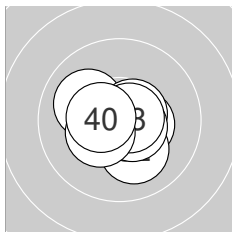

Serie 4: 105.0 (100)

10.4* →	10.1 ↘	10.8* ↗	10.9* ↗	10.0 ↖
10.6* ↗	10.6* ↘	10.7* →	10.4* ↗	10.5* ←

beste Teiler: 25.2 (34.), 41.4 (33.), 64.5 (38.)
 Trefferlage: 0.00 mm , 0.17 mm tief
 Streuwert: 0.97, horizontal: 1.13, vertikal: 0.78



Ergebnis: 422.0 (400)
Serien: 105.5 105.3 105.5 105.7
Zähler: 40 0 0 0 0 0 0 0 0 0 0
Innenzehner: 38
Weiteste: 224 (18.), 219 (24.), 194 (4.)
beste Teiler: 13.0 (40.), 14.8 (20.), 15.8 (7.)
Trefferlage: 0.09 mm links, 0.05 mm tief
Streuwert: 0.83, horizontal: 0.79, vertikal: 0.88

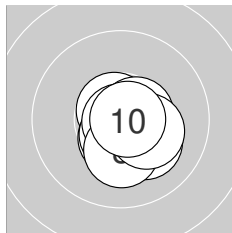
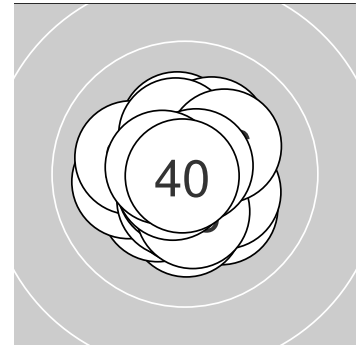

Serie 1: 105.5 (100)

10.7* ↘	10.7* ↘	10.5* ↓	10.2* ↘	10.6* →
10.6* ↓	10.9* ↓	10.2* ↓	10.3* →	10.8* →

beste Teiler: 15.8 (7.), 42.0 (10.), 65.2 (2.)
Trefferlage: 0.39 mm rechts, 0.56 mm tief
Streuwert: 0.72, horizontal: 0.70, vertikal: 0.74

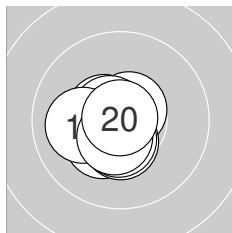

Serie 2: 105.3 (100)

10.8* ←	10.5* ↘	10.6* ↗	10.3* ↗	10.4* ↓
10.5* ↓	10.7* ↘	10.1 ←	10.5* ↓	10.9* ↗

beste Teiler: 14.8 (20.), 30.5 (11.), 75.8 (17.)
Trefferlage: 0.52 mm links, 0.32 mm tief
Streuwert: 0.76, horizontal: 0.76, vertikal: 0.76

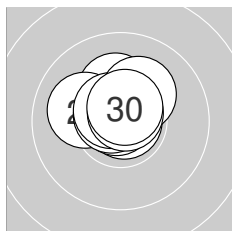

Serie 3: 105.5 (100)

10.9* →	10.2* ↑	10.8* ↘	10.1 ←	10.7* ↑
10.7* ↘	10.6* ↘	10.2* ↗	10.7* ↗	10.6* ↑

beste Teiler: 21.0 (21.), 31.8 (23.), 55.5 (29.)
Trefferlage: 0.19 mm links, 0.72 mm hoch
Streuwert: 0.71, horizontal: 0.82, vertikal: 0.57

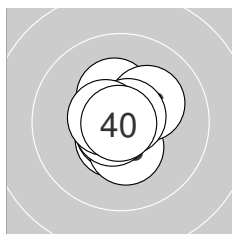

Serie 4: 105.7 (100)

10.3* ↑	10.8* ↓	10.5* ↓	10.7* ↗	10.3* ↓
10.2* ↗	10.7* ↗	10.7* ↗	10.6* ←	10.9* ↗

beste Teiler: 13.0 (40.), 27.2 (32.), 55.0 (37.)
Trefferlage: 0.04 mm links, 0.04 mm tief
Streuwert: 0.81, horizontal: 0.69, vertikal: 0.91



Ergebnis: **420.8** (398)
 Serien: 105.1 105.7 103.5 106.5
 Zähler: 38 2 0 0 0 0 0 0 0 0
 Innenzehner: 36
 Weitester: 318 (26.), 251 (25.), 230 (24.)
 beste Teiler: 5.0 (31.), 13.4 (10.), 19.1 (20.)
 Trefferlage: 0.15 mm links, 0.06 mm tief
 Streuwert: 0.91, horizontal: 1.03, vertikal: 0.76

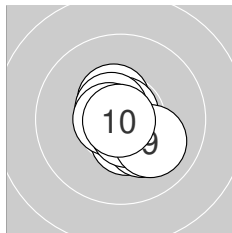
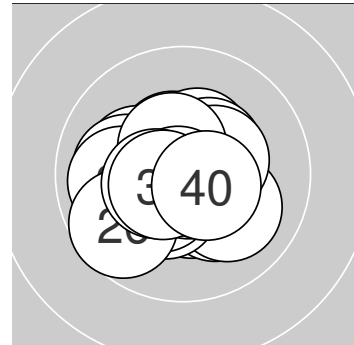

Serie 1: 105.1 (100)

10.4* ↘	10.4* ↓	10.5* ↗	10.8* ↑	10.6* ↖
10.2* ↘	10.7* ←	10.6* ↓	10.0 ↘	10.9* ↗

beste Teiler: 13.4 (10.), 39.0 (4.), 70.0 (7.)
 Trefferlage: 0.30 mm rechts, 0.34 mm tief
 Streuwert: 0.86, horizontal: 0.83, vertikal: 0.89

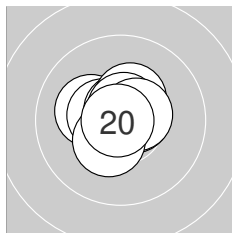

Serie 2: 105.7 (100)

10.8* ↖	10.6* →	10.2* ←	10.5* ←	10.7* ↑
10.4* ↑	10.7* ↑	10.5* →	10.4* ↗	10.9* ←

beste Teiler: 19.1 (20.), 43.8 (11.), 60.0 (15.)
 Trefferlage: 0.16 mm links, 0.29 mm hoch
 Streuwert: 0.77, horizontal: 0.88, vertikal: 0.65

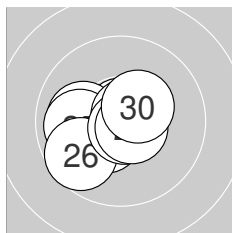

Serie 3: 103.5 (98)

10.4* ↗	10.8* ↑	10.2* ←	10.0 ←	9.9 ←
9.7 ↗	10.7* ↗	10.8* ↓	10.6* ↘	10.4* ↗

beste Teiler: 42.0 (22.), 46.5 (28.), 57.3 (27.)
 Trefferlage: 0.75 mm links, 0.27 mm tief
 Streuwert: 1.15, horizontal: 1.39, vertikal: 0.83

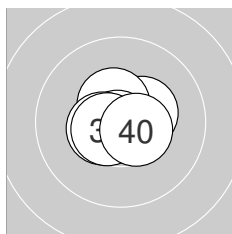

Serie 4: 106.5 (100)

10.9* ↗	10.9* ↗	10.8* ↖	10.6* ↗	10.4* →
10.5* ↖	10.8* ↗	10.5* ←	10.6* ↗	10.5* ↘

beste Teiler: 5.0 (31.), 24.0 (32.), 34.4 (37.)
 Trefferlage: 0.02 mm links, 0.07 mm hoch
 Streuwert: 0.66, horizontal: 0.77, vertikal: 0.54



Ergebnis: 420.1 (399)
Serien: 104.1 106.1 105.3 104.6
Zähler: 39 1 0 0 0 0 0 0 0 0 0
Innenzehner: 37
Weiteste: 302 (8.), 204 (9.), 201 (29.)
beste Teiler: 5.0 (17.), 11.3 (16.), 22.0 (12.)
Trefferlage: 0.35 mm rechts, 0.17 mm hoch
Streuwert: 0.84, horizontal: 0.79, vertikal: 0.89

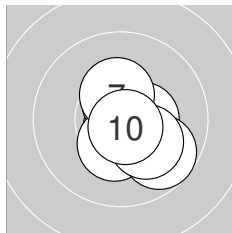
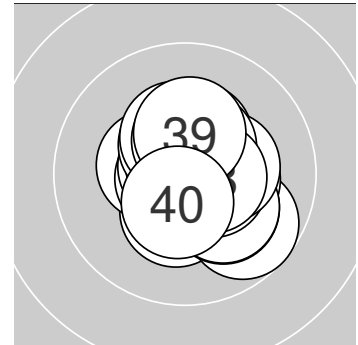

Serie 1: 104.1 (99)

10.7* ↓	10.5* ↓	10.6* ↑	10.3* ↓	10.7* ↘
10.4* →	10.4* ↑	9.7 ↘	10.1 ↘	10.7* ↘

beste Teiler: 51.0 (1.), 55.2 (10.), 56.0 (5.)
Trefferlage: 0.55 mm rechts, 0.46 mm tief
Streuwert: 0.98, horizontal: 0.87, vertikal: 1.07

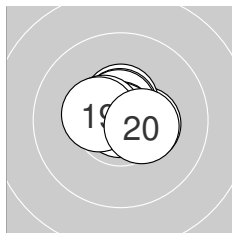

Serie 2: 106.1 (100)

10.4* →	10.9* ↑	10.5* ↑	10.6* ↑	10.6* ↑
10.9* ↘	10.9* ←	10.5* ←	10.4* ←	10.4* →

beste Teiler: 5.0 (17.), 11.3 (16.), 22.0 (12.)
Trefferlage: 0.00 mm, 0.32 mm hoch
Streuwert: 0.68, horizontal: 0.83, vertikal: 0.48

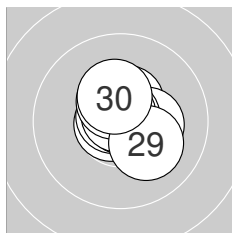

Serie 3: 105.3 (100)

10.7* ←	10.6* ↑	10.7* ↘	10.5* ↑	10.3* →
10.8* ↑	10.8* ↑	10.5* ↑	10.1 ↘	10.3* ↑

beste Teiler: 27.7 (26.), 41.1 (27.), 53.8 (23.)
Trefferlage: 0.19 mm rechts, 0.38 mm hoch
Streuwert: 0.80, horizontal: 0.78, vertikal: 0.82

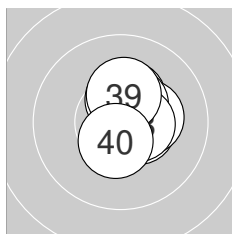

Serie 4: 104.6 (100)

10.4* ↑	10.7* ↗	10.5* →	10.5* →	10.4* ↑
10.3* →	10.5* ↑	10.5* →	10.3* ↑	10.5* ↓

beste Teiler: 53.2 (32.), 103.6 (38.), 110.8 (34.)
Trefferlage: 0.64 mm rechts, 0.45 mm hoch
Streuwert: 0.75, horizontal: 0.58, vertikal: 0.89



Ergebnis: **419.0** (398)
 Serien: 104.5 104.0 105.7 104.8
 Zähler: 38 2 0 0 0 0 0 0 0 0
 Innenzehner: 36
 Weitester: 347 (7.), 290 (13.), 221 (39.)
 beste Teiler: 20.1 (27.), 29.8 (21.), 31.7 (8.)
 Trefferlage: 0.00 mm , 0.03 mm tief
 Streuwert: 0.99, horizontal: 1.04, vertikal: 0.93

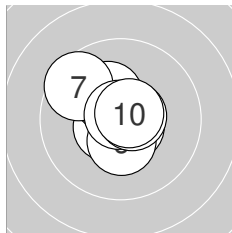
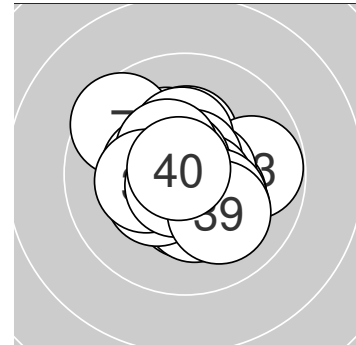

Serie 1: 104.5 (99)

10.5* ↖	10.7* ↘	10.6* ↙	10.3* ↖	10.3* ↖
10.4* ↓	9.6 ↖	10.8* ↖	10.6* →	10.7* ↗

beste Teiler: 31.7 (8.), 68.2 (10.), 75.6 (2.)
 Trefferlage: 0.41 mm links, 0.44 mm hoch
 Streuwert: 1.06, horizontal: 1.04, vertikal: 1.08

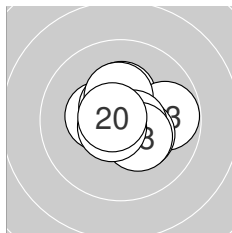

Serie 2: 104.0 (99)

10.4* ←	10.3* ↑	9.8 →	10.3* ↘	10.6* ↖
10.3* ↑	10.6* ↘	10.3* ↘	10.7* ↙	10.7* ↖

beste Teiler: 57.2 (20.), 71.8 (19.), 83.8 (17.)
 Trefferlage: 0.30 mm rechts, 0.19 mm hoch
 Streuwert: 1.09, horizontal: 1.24, vertikal: 0.92

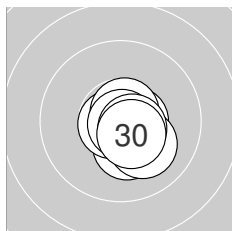

Serie 3: 105.7 (100)

10.8* ↙	10.6* →	10.5* ↘	10.3* ↓	10.7* ↙
10.7* ↑	10.9* ↘	10.1 ↘	10.6* ↘	10.5* ↘

beste Teiler: 20.1 (27.), 29.8 (21.), 57.5 (25.)
 Trefferlage: 0.46 mm rechts, 0.52 mm tief
 Streuwert: 0.63, horizontal: 0.59, vertikal: 0.67

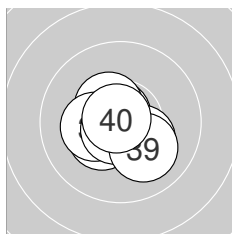

Serie 4: 104.8 (100)

10.6* ←	10.7* ↖	10.4* ↖	10.3* ↘	10.5* ←
10.4* ↙	10.3* ←	10.7* ↙	10.1 ↘	10.8* ↖

beste Teiler: 36.1 (40.), 55.5 (32.), 60.8 (38.)
 Trefferlage: 0.37 mm links, 0.28 mm tief
 Streuwert: 0.93, horizontal: 1.04, vertikal: 0.80



Ergebnis: 414.8 (396)
Serien: 102.9 103.2 104.1 104.6
Zähler: 36 4 0 0 0 0 0 0 0 0 0
Innenzehner: 30
Weiteste: 387 (3.), 309 (14.), 266 (21.)
beste Teiler: 34.0 (28.), 47.0 (11.), 47.1 (32.)
Trefferlage: 0.46 mm links, 0.18 mm hoch
Streuwert: 1.15, horizontal: 1.42, vertikal: 0.80

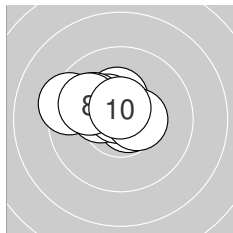
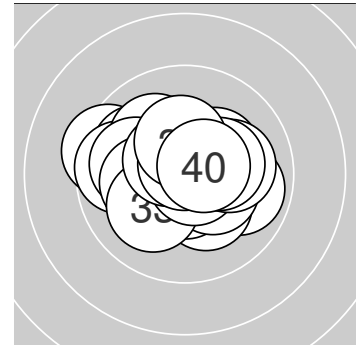

Serie 1: 102.9 (98)

10.7* →	10.3* ↑	9.4 ←	10.4* ↖	10.3* ↖
10.1 ↖	10.7* ↖	9.9 ↖	10.5* →	10.6* ↑

beste Teiler: 55.1 (7.), 58.2 (1.), 82.1 (10.)
Trefferlage: 0.91 mm links, 0.75 mm hoch
Streuwert: 1.10, horizontal: 1.46, vertikal: 0.54

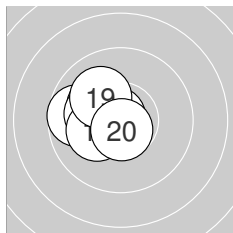

Serie 2: 103.2 (99)

10.8* ↙	10.1 ←	10.4* ←	9.7 ←	10.8* ↖
10.2* ↖	10.2* ↖	10.2* ←	10.1 ↖	10.7* ↓

beste Teiler: 47.0 (11.), 47.4 (15.), 69.4 (20.)
Trefferlage: 1.37 mm links, 0.18 mm hoch
Streuwert: 0.86, horizontal: 0.95, vertikal: 0.74

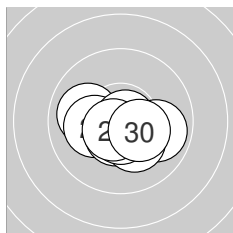

Serie 3: 104.1 (99)

9.9 →	10.0 ←	10.2* ←	10.8* ↓	10.5* ↓
10.3* ↘	10.6* ↓	10.8* →	10.6* ↙	10.4* ↘

beste Teiler: 34.0 (28.), 50.2 (24.), 82.3 (29.)
Trefferlage: 0.03 mm rechts, 0.56 mm tief
Streuwert: 1.10, horizontal: 1.46, vertikal: 0.54

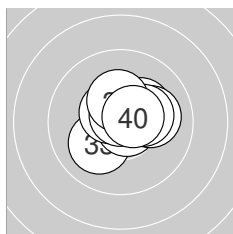

Serie 4: 104.6 (100)

10.3* ↗	10.8* ↑	10.1 ↙	10.8* ↘	10.5* ↖
10.1 →	10.8* ↑	10.3* →	10.3* ↑	10.6* ↗

beste Teiler: 47.1 (32.), 49.6 (34.), 50.0 (37.)
Trefferlage: 0.40 mm rechts, 0.37 mm hoch
Streuwert: 0.98, horizontal: 1.14, vertikal: 0.80



Ergebnis: 421.9 (397)
Serien: 105.9 103.9 106.4 105.7
Zähler: 37 3 0 0 0 0 0 0 0 0 0
Innenzehner: 34
Weiteste: 344 (10.), 274 (12.), 272 (11.)
beste Teiler: 11.7 (30.), 14.7 (2.), 27.5 (18.)
Trefferlage: 0.08 mm links, 0.21 mm hoch
Streuwert: 0.92, horizontal: 1.08, vertikal: 0.72

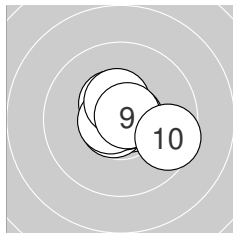
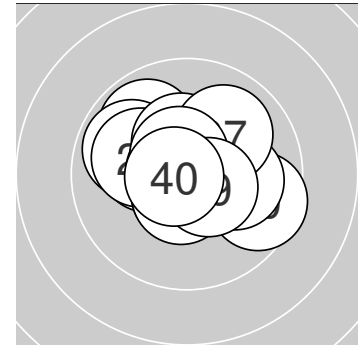

Serie 1: 105.9 (99)

10.7* →	10.9* ↙	10.8* ←	10.7* ↙	10.5* ↖
10.8* ↗	10.7* ←	10.5* ↑	10.7* ↗	9.6* ↘

beste Teiler: 14.7 (2.), 34.4 (6.), 39.0 (3.)
Trefferlage: 0.21 mm rechts, 0.10 mm hoch
Streuwert: 0.95, horizontal: 1.15, vertikal: 0.68

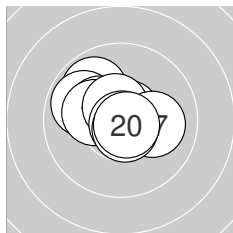

Serie 2: 103.9 (98)

9.9 ↖	9.9 ↙	10.3* ↖	10.7* ↗	10.2* ↖
10.6* ↖	10.1 →	10.8* ↓	10.7* ↓	10.7* ↘

beste Teiler: 27.5 (18.), 51.2 (20.), 65.7 (14.)
Trefferlage: 0.44 mm links, 0.44 mm hoch
Streuwert: 1.15, horizontal: 1.41, vertikal: 0.82

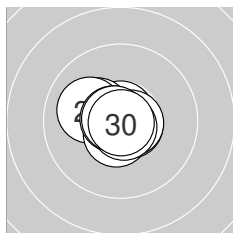

Serie 3: 106.4 (100)

10.8* ↑	10.3* ↖	10.1 ↖	10.6* ↓	10.7* ↘
10.7* ↖	10.7* →	10.8* ↓	10.8* ↖	10.9* ↓

beste Teiler: 11.7 (30.), 43.6 (29.), 46.5 (28.)
Trefferlage: 0.33 mm links, 0.04 mm hoch
Streuwert: 0.73, horizontal: 0.89, vertikal: 0.51

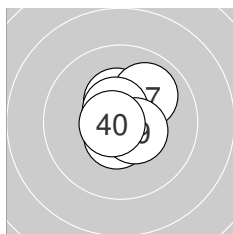

Serie 4: 105.7 (100)

10.8* ↑	10.8* ↖	10.7* ↗	10.6* ↘	10.6* ↓
10.4* ↑	10.0 ↗	10.6* ↖	10.5* ↘	10.7* ↖

beste Teiler: 38.6 (31.), 48.4 (32.), 51.1 (33.)
Trefferlage: 0.21 mm rechts, 0.28 mm hoch
Streuwert: 0.81, horizontal: 0.74, vertikal: 0.87



LG 40 AUT Senioren

Männer

StartNr: 270

StandNr: 66

Wertung

21.03.2024 14:06

Reiner, Andreas #266

B – SSV Breitenbrunn / Burgenland 1

Ergebnis: **420.5** (400)
 Serien: 105.1 105.9 104.9 104.6
 Zähler: 40 0 0 0 0 0 0 0 0 0
 Innenzehner: 37
 Weitestе: 235 (37.), 226 (28.), 214 (33.)
 beste Teiler: 16.1 (30.), 17.4 (32.), 26.2 (9.)
 Trefferlage: 0.04 mm rechts, 0.09 mm tief
 Streuwert: 0.89, horizontal: 0.91, vertikal: 0.87

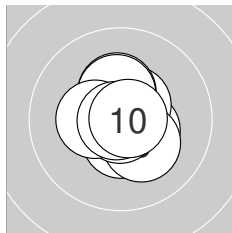
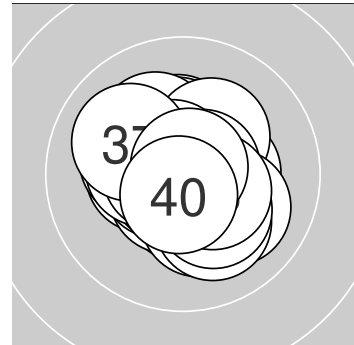

Serie 1: 105.1 (100)

10.5* ↓	10.4* ↘	10.5* ↗	10.3* ↑	10.4* ↑
10.2* ↘	10.8* ↓	10.4* ←	10.8* ←	10.8* →

beste Teiler: 26.2 (9.), 28.4 (7.), 43.1 (10.)
 Trefferlage: 0.12 mm rechts, 0.03 mm hoch
 Streuwert: 0.89, horizontal: 0.79, vertikal: 0.99

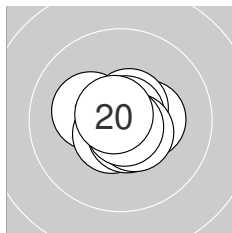

Serie 2: 105.9 (100)

10.6* ←	10.4* →	10.2* ←	10.6* ↗	10.6* ↘
10.8* ↗	10.6* ↘	10.5* ↘	10.8* ↘	10.8* ↘

beste Teiler: 40.3 (16.), 44.7 (19.), 49.6 (20.)
 Trefferlage: 0.02 mm rechts, 0.07 mm tief
 Streuwert: 0.75, horizontal: 0.90, vertikal: 0.56

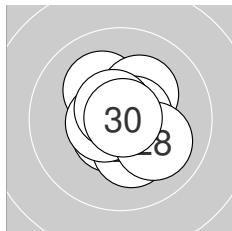

Serie 3: 104.9 (100)

10.8* ↓	10.2* ↘	10.2* ↗	10.7* →	10.6* ↘
10.2* ↘	10.6* ←	10.0 ↘	10.7* ↘	10.9* ↗

beste Teiler: 16.1 (30.), 45.7 (21.), 73.2 (29.)
 Trefferlage: 0.13 mm rechts, 0.03 mm tief
 Streuwert: 1.01, horizontal: 0.94, vertikal: 1.08

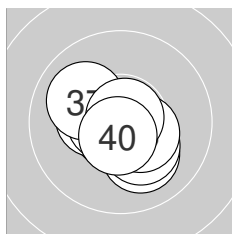

Serie 4: 104.6 (100)

10.7* ↗	10.9* ↗	10.1 ↘	10.2* ↘	10.3* ←
10.6* ←	10.0 ↘	10.4* ↘	10.8* ↗	10.6* ↓

beste Teiler: 17.4 (32.), 36.1 (39.), 66.5 (31.)
 Trefferlage: 0.12 mm links, 0.31 mm tief
 Streuwert: 1.00, horizontal: 1.11, vertikal: 0.88



LG 40 AUT Senioren

StandNr: 67

Kraushofer, Andreas #267

Männer

Wertung

NÖ – SchV Frankenfels / Niederösterreich 1

StartNr: 271

21.03.2024 13:47

Ergebnis: **420.5** (399)
 Serien: 105.5 104.2 105.4 105.4
 Zähler: 39 1 0 0 0 0 0 0 0 0
 Innenzehner: 36
 Weitestе: 253 (36.), 248 (18.), 242 (30.)
 beste Teiler: 12.8 (37.), 23.6 (4.), 44.6 (14.)
 Trefferlage: 0.20 mm rechts, 0.00 mm
 Streuwert: 0.89, horizontal: 0.79, vertikal: 0.98

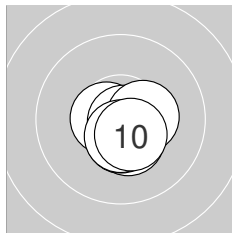
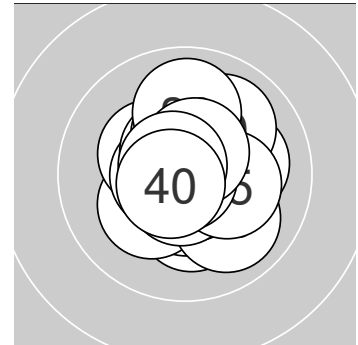

Serie 1: 105.5 (100)

10.6* ←	10.6* →	10.6* ↓	10.9* ↘	10.5* ↓
10.4* ↓	10.4* →	10.5* ↓	10.5* ↓	10.5* ↘

beste Teiler: 23.6 (4.), 87.5 (3.), 88.2 (1.)
 Trefferlage: 0.30 mm rechts, 0.63 mm tief
 Streuwert: 0.58, horizontal: 0.61, vertikal: 0.55

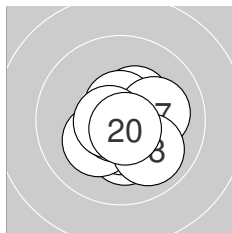

Serie 2: 104.2 (100)

10.2* ↓	10.5* ↓	10.2* ↗	10.8* ↗	10.4* ↗
10.6* ↑	10.1 →	10.0 ↘	10.7* ←	10.7* ↘

beste Teiler: 44.6 (14.), 59.9 (20.), 68.7 (19.)
 Trefferlage: 0.28 mm rechts, 0.45 mm tief
 Streuwert: 1.04, horizontal: 1.04, vertikal: 1.04

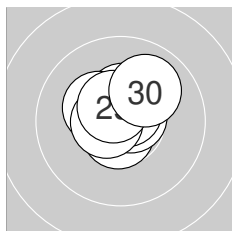

Serie 3: 105.4 (100)

10.7* ↑	10.4* ↑	10.7* ↗	10.7* ↓	10.7* ↗
10.7* ↗	10.3* ↘	10.6* ←	10.6* ↘	10.0 ↗

beste Teiler: 57.4 (21.), 68.3 (23.), 68.9 (25.)
 Trefferlage: 0.00 mm, 0.63 mm hoch
 Streuwert: 0.76, horizontal: 0.80, vertikal: 0.71

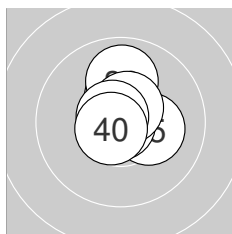

Serie 4: 105.4 (99)

10.6* →	10.7* →	10.3* ↑	10.8* ←	10.2* →
9.9 ↑	10.9* ↗	10.6* ↗	10.7* ↘	10.7* ↗

beste Teiler: 12.8 (37.), 45.8 (34.), 61.8 (39.)
 Trefferlage: 0.22 mm rechts, 0.44 mm hoch
 Streuwert: 0.86, horizontal: 0.73, vertikal: 0.96



Ergebnis: **413.4** (393)
 Serien: 104.4 102.5 104.0 102.5
 Zähler: 33 7 0 0 0 0 0 0 0 0
 Innenzehner: 29
 Weitester: 399 (11.), 379 (35.), 295 (22.)
 beste Teiler: 22.0 (29.), 26.2 (27.), 26.8 (12.)
 Trefferlage: 0.10 mm rechts, 0.26 mm tief
 Streuwert: 1.27, horizontal: 1.40, vertikal: 1.13

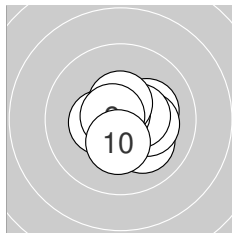
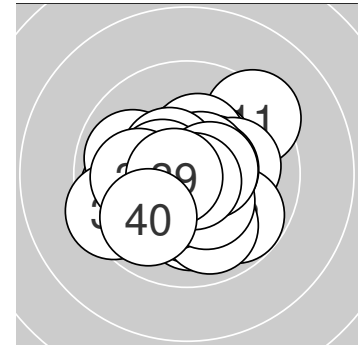

Serie 1: 104.4 (100)

10.1 ↘	10.2* →	10.4* ←	10.7* ↗	10.2* →
10.5* →	10.8* ↖	10.5* ↑	10.7* ↖	10.3* ↓

beste Teiler: 42.9 (7.), 61.0 (9.), 63.0 (4.)
 Trefferlage: 0.46 mm rechts, 0.08 mm tief
 Streuwert: 1.00, horizontal: 1.11, vertikal: 0.87

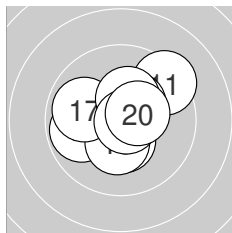

Serie 2: 102.5 (97)

9.4 ↗	10.8* ↘	10.4* ↗	10.4* ↓	9.8 ←
10.3* ↓	9.9 ←	10.3* ↑	10.8* →	10.4* →

beste Teiler: 26.8 (12.), 41.2 (19.), 127.3 (20.)
 Trefferlage: 0.09 mm rechts, 0.25 mm hoch
 Streuwert: 1.51, horizontal: 1.69, vertikal: 1.30

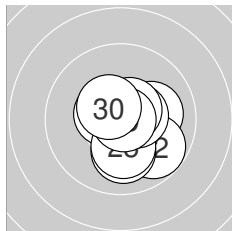

Serie 3: 104.0 (99)

10.1 →	9.8 ↘	10.1 ↓	10.5* ↖	10.2* ↓
10.5* →	10.8* ↗	10.6* ↗	10.9* →	10.5* ↖

beste Teiler: 22.0 (29.), 26.2 (27.), 90.5 (28.)
 Trefferlage: 0.50 mm rechts, 0.33 mm tief
 Streuwert: 1.13, horizontal: 1.08, vertikal: 1.17

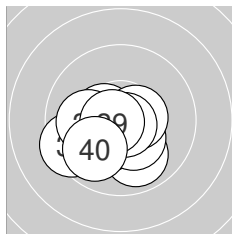

Serie 4: 102.5 (97)

9.9 ↓	10.4* ↙	10.5* ←	10.3* ↘	9.4 ←
10.5* →	10.1 ←	10.8* ↘	10.7* ←	9.9 ↙

beste Teiler: 43.2 (38.), 60.4 (39.), 106.5 (36.)
 Trefferlage: 0.65 mm links, 0.87 mm tief
 Streuwert: 1.27, horizontal: 1.52, vertikal: 0.97



LG 40 AUT Senioren

StandNr: 69

Hanser, Hannes #269

Männer

Wertung

StartNr: 273

21.03.2024 14:02

T – SG Aschau / Tirol 1

Ergebnis: **419.3** (399)
 Serien: 106.2 103.7 105.7 103.7
 Zähler: 39 1 0 0 0 0 0 0 0 0
 Innenzehner: 36
 Weitestе: 289 (38.), 233 (20.), 214 (3.)
 beste Teiler: 9.8 (21.), 16.1 (9.), 23.1 (23.)
 Trefferlage: 0.11 mm rechts, 0.01 mm tief
 Streuwert: 0.98, horizontal: 0.86, vertikal: 1.09

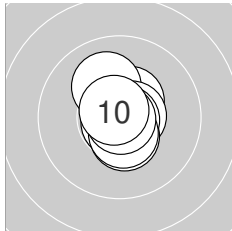
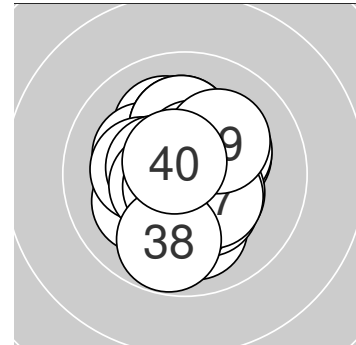

Serie 1: 106.2 (100)

10.5* ↗	10.8* ↑	10.1 ↘	10.8* ↙	10.6* →
10.5* ↓	10.8* ↘	10.5* ↓	10.9* ↓	10.7* ↘

beste Teiler: 16.1 (9.), 27.2 (2.), 37.5 (7.)
 Trefferlage: 0.08 mm rechts, 0.09 mm hoch
 Streuwert: 0.74, horizontal: 0.48, vertikal: 0.93

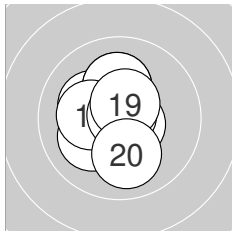

Serie 2: 103.7 (100)

10.7* ↘	10.2* ↖	10.2* ↑	10.2* ↑	10.1 ↖
10.2* ←	10.6* ↘	10.9* ↗	10.6* ↗	10.0 ↓

beste Teiler: 25.2 (18.), 61.5 (11.), 81.0 (17.)
 Trefferlage: 0.35 mm links, 0.18 mm hoch
 Streuwert: 1.19, horizontal: 1.02, vertikal: 1.34

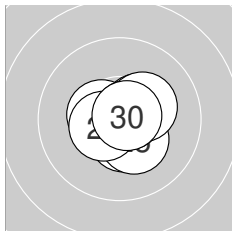

Serie 3: 105.7 (100)

10.9* ↙	10.5* ↓	10.9* ↓	10.4* ↗	10.3* ↘
10.5* ←	10.5* ↖	10.7* ↗	10.3* ↗	10.7* ↗

beste Teiler: 9.8 (21.), 23.1 (23.), 52.3 (30.)
 Trefferlage: 0.26 mm rechts, 0.09 mm tief
 Streuwert: 0.79, horizontal: 0.86, vertikal: 0.70

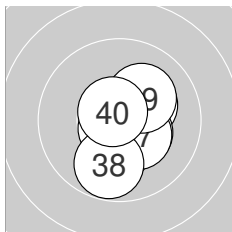

Serie 4: 103.7 (99)

10.2* ↗	10.4* ↘	10.2* ↓	10.3* ↗	10.7* ↙
10.8* ↗	10.4* ↘	9.8 ↓	10.2* ↗	10.7* ↘

beste Teiler: 43.4 (36.), 68.2 (35.), 70.2 (40.)
 Trefferlage: 0.48 mm rechts, 0.26 mm tief
 Streuwert: 1.14, horizontal: 0.86, vertikal: 1.36



Ergebnis: **422.6** (399)
 Serien: 106.3 106.0 105.6 104.7
 Zähler: 39 1 0 0 0 0 0 0 0 0
 Innenzehner: 38
 Weitestе: 251 (35.), 201 (39.), 180 (21.)
 beste Teiler: 8.0 (33.), 16.4 (7.), 19.2 (13.)
 Trefferlage: 0.24 mm links, 0.00 mm
 Streuwert: 0.78, horizontal: 0.62, vertikal: 0.90

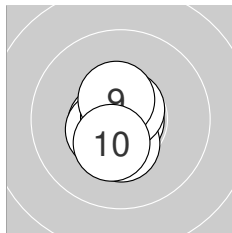
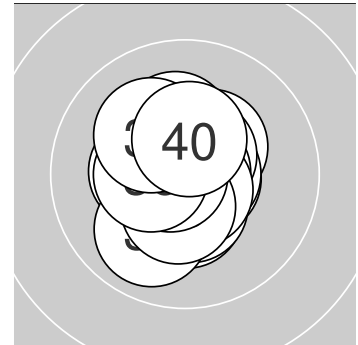

Serie 1: 106.3 (100)

10.8* →	10.6* ↓	10.6* ←	10.9* ←	10.5* ↙
10.4* ↓	10.9* ↘	10.7* ↗	10.5* ↑	10.4* ↓

beste Teiler: 16.4 (7.), 25.9 (4.), 31.3 (1.)
 Trefferlage: 0.26 mm links, 0.26 mm tief
 Streuwert: 0.66, horizontal: 0.44, vertikal: 0.82

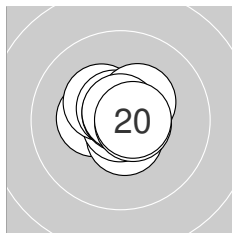

Serie 2: 106.0 (100)

10.3* ←	10.5* ↓	10.9* ↓	10.3* ↖	10.6* ↖
10.4* ↗	10.8* ↑	10.8* ↑	10.7* →	10.7* →

beste Teiler: 19.2 (13.), 40.0 (17.), 47.0 (18.)
 Trefferlage: 0.03 mm links, 0.24 mm hoch
 Streuwert: 0.72, horizontal: 0.80, vertikal: 0.63

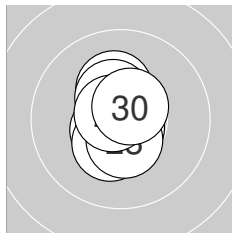

Serie 3: 105.6 (100)

10.2* ↑	10.8* ↓	10.6* ↘	10.8* ↖	10.7* ↓
10.4* ↖	10.3* ↓	10.5* ↓	10.7* ↖	10.6* ↗

beste Teiler: 34.1 (24.), 35.3 (22.), 58.8 (29.)
 Trefferlage: 0.16 mm links, 0.02 mm hoch
 Streuwert: 0.79, horizontal: 0.44, vertikal: 1.03

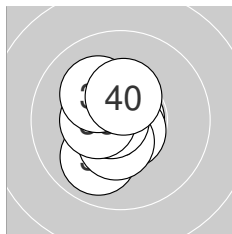

Serie 4: 104.7 (99)

10.4* ↖	10.8* →	10.9* ↑	10.7* ↓	9.9 ↙
10.4* ↓	10.7* ←	10.4* ←	10.1 ↖	10.4* ↑

beste Teiler: 8.0 (33.), 32.9 (32.), 57.0 (37.)
 Trefferlage: 0.50 mm links, 0.01 mm tief
 Streuwert: 0.95, horizontal: 0.72, vertikal: 1.13



Ergebnis: 418.8 (398)
Serien: 104.7 104.6 105.7 103.8
Zähler: 38 2 0 0 0 0 0 0 0 0
Innenzehner: 36
Weiteste: 324 (37.), 290 (40.), 229 (17.)
beste Teiler: 22.6 (9.), 24.6 (23.), 26.4 (20.)
Trefferlage: 0.07 mm links, 0.07 mm hoch
Streuwert: 1.00, horizontal: 1.13, vertikal: 0.86

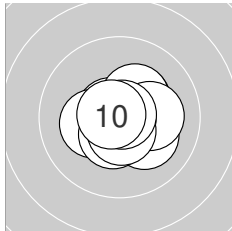
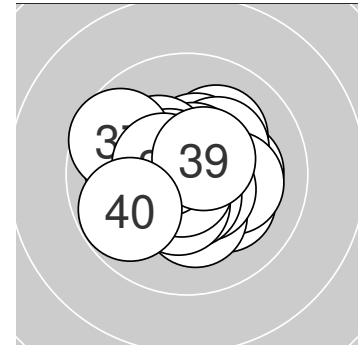

Serie 1: 104.7 (100)

10.7* ↖	10.3* ↗	10.2* ↘	10.3* ↗	10.2* →
10.3* ←	10.5* ↓	10.6* ↓	10.9* ↗	10.7* ↖

beste Teiler: 22.6 (9.), 56.9 (10.), 65.5 (1.)
Trefferlage: 0.27 mm rechts, 0.04 mm tief
Streuwert: 1.00, horizontal: 1.13, vertikal: 0.85

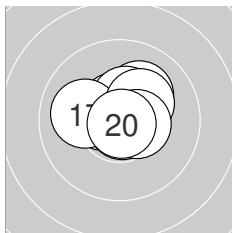

Serie 2: 104.6 (100)

10.6* ↖	10.6* ↖	10.5* ←	10.8* ↘	10.1 ↗
10.4* ↑	10.0 ←	10.3* ↗	10.5* →	10.8* ↘

beste Teiler: 26.4 (20.), 36.7 (14.), 85.5 (11.)
Trefferlage: 0.02 mm rechts, 0.53 mm hoch
Streuwert: 0.93, horizontal: 1.12, vertikal: 0.68

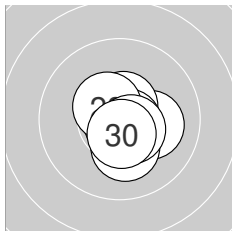

Serie 3: 105.7 (100)

10.2* →	10.8* ↘	10.9* ↓	10.6* ↘	10.2* ↓
10.6* ↑	10.7* ↘	10.5* ↖	10.6* ↘	10.6* ↓

beste Teiler: 24.6 (23.), 30.0 (22.), 55.4 (27.)
Trefferlage: 0.39 mm rechts, 0.34 mm tief
Streuwert: 0.75, horizontal: 0.70, vertikal: 0.79

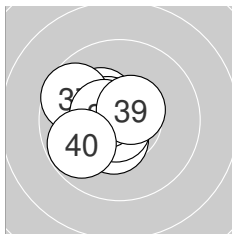

Serie 4: 103.8 (98)

10.4* ←	10.8* ←	10.4* ↓	10.3* ↖	10.7* ↓
10.6* ↖	9.7 ↖	10.5* ←	10.6* ↗	9.8 ↖

beste Teiler: 41.0 (32.), 53.2 (35.), 96.2 (36.)
Trefferlage: 1.00 mm links, 0.13 mm hoch
Streuwert: 1.03, horizontal: 1.07, vertikal: 0.98



Ergebnis: **405.9** (386)
 Serien: 101.0 100.3 101.7 102.9
 Zähler: 27 12 1 0 0 0 0 0 0 0
 Innenzehner: 23
 Weitest: 510 (7.), 405 (6.), 356 (17.)
 beste Teiler: 27.0 (35.), 31.3 (23.), 51.0 (3.)
 Trefferlage: 0.14 mm links, 0.08 mm tief
 Streuwert: 1.60, horizontal: 1.88, vertikal: 1.26

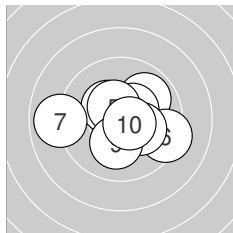
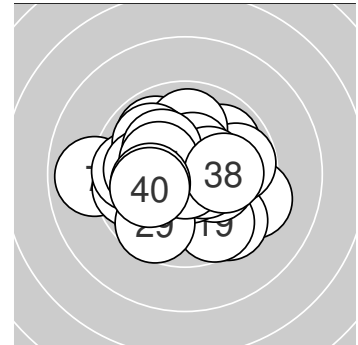

Serie 1: 101.0 (96)

9.9 ↗	10.4* ↗	10.7* →	10.3* ↖	10.5* ↖
9.3 →	8.9 ←	10.2* →	10.2* ↓	10.6* →

beste Teiler: 51.0 (3.), 82.7 (10.), 121.7 (5.)
 Trefferlage: 0.25 mm rechts, 0.02 mm tief
 Streuwert: 1.86, horizontal: 2.36, vertikal: 1.17

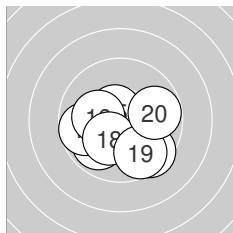

Serie 2: 100.3 (95)

9.9 ↙	10.5* ←	9.7 ←	10.2* →	10.6* ↖
10.2* ←	9.5 ↘	10.2* ↙	9.7 ↘	9.8 →

beste Teiler: 89.0 (15.), 110.6 (12.), 182.8 (18.)
 Trefferlage: 0.05 mm links, 0.85 mm tief
 Streuwert: 1.72, horizontal: 2.06, vertikal: 1.29

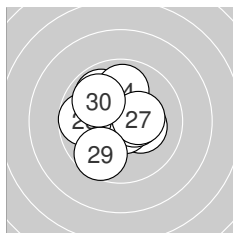

Serie 3: 101.7 (95)

10.3* →	9.9 ↖	10.8* ←	9.9 ↑	10.7* ↘
10.5* →	10.3* →	9.7 ←	9.7 ↙	9.9 ↖

beste Teiler: 31.3 (23.), 57.6 (25.), 118.1 (26.)
 Trefferlage: 0.37 mm links, 0.30 mm hoch
 Streuwert: 1.58, horizontal: 1.61, vertikal: 1.55

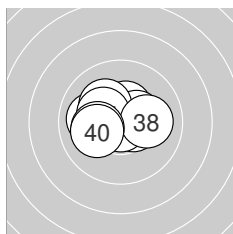

Serie 4: 102.9 (100)

10.0 ←	10.5* →	10.4* ↑	10.4* →	10.8* ↓
10.2* ↖	10.3* ↖	10.1 →	10.1 ←	10.1 ←

beste Teiler: 27.0 (35.), 109.1 (32.), 129.9 (33.)
 Trefferlage: 0.40 mm links, 0.23 mm hoch
 Streuwert: 1.25, horizontal: 1.61, vertikal: 0.72



Ergebnis: 421.8 (399)
Serien: 105.6 105.3 105.2 105.7
Zähler: 39 1 0 0 0 0 0 0 0 0
Innenzehner: 37
Weiteste: 285 (29.), 220 (6.), 204 (18.)
beste Teiler: 14.8 (15.), 20.0 (24.), 25.0 (12.)
Trefferlage: 0.01 mm links, 0.22 mm tief
Streuwert: 0.85, horizontal: 0.85, vertikal: 0.85

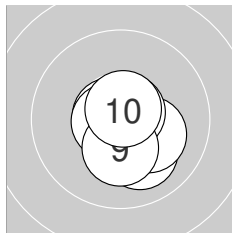
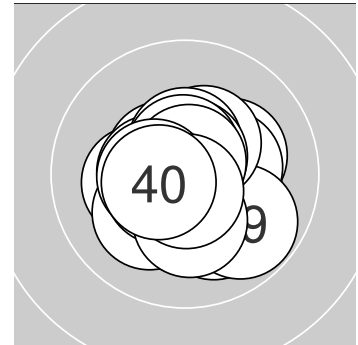

Serie 1: 105.6 (100)

10.8* ←	10.7* ←	10.8* →	10.6* ↓	10.7* ←
10.1 ↘	10.2* ↘	10.7* ↗	10.3* ↓	10.7* ↑

beste Teiler: 32.2 (3.), 50.6 (1.), 55.9 (8.)
Trefferlage: 0.16 mm rechts, 0.42 mm tief
Streuwert: 0.81, horizontal: 0.74, vertikal: 0.88

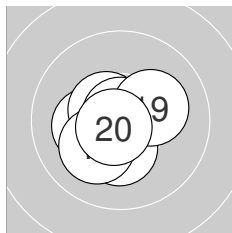

Serie 2: 105.3 (100)

10.2* ←	10.9* ↑	10.7* ↓	10.5* ↖	10.9* ↗
10.3* ↓	10.8* ↑	10.1 ↙	10.2* →	10.7* ↘

beste Teiler: 14.8 (15.), 25.0 (12.), 28.0 (17.)
Trefferlage: 0.26 mm links, 0.27 mm tief
Streuwert: 0.89, horizontal: 0.97, vertikal: 0.81

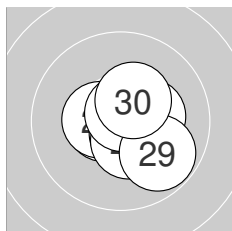

Serie 3: 105.2 (99)

10.8* ↓	10.3* →	10.6* ←	10.9* ←	10.5* ←
10.6* ↘	10.5* ↘	10.8* ↑	9.8 ↘	10.4* ↗

beste Teiler: 20.0 (24.), 44.7 (21.), 47.8 (28.)
Trefferlage: 0.32 mm rechts, 0.22 mm tief
Streuwert: 0.95, horizontal: 1.03, vertikal: 0.87

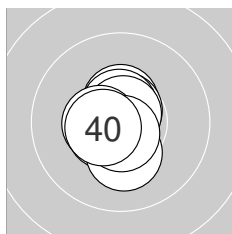

Serie 4: 105.7 (100)

10.5* ↖	10.7* ↑	10.2* ↓	10.5* ↑	10.7* ↑
10.6* ↑	10.8* ↑	10.5* ←	10.7* ↓	10.5* ←

beste Teiler: 50.2 (37.), 60.5 (32.), 67.1 (39.)
Trefferlage: 0.27 mm links, 0.03 mm hoch
Streuwert: 0.74, horizontal: 0.55, vertikal: 0.89



Ergebnis: **426.2** (400)
Serien: 106.7 106.5 106.4 106.6
Zähler: 40 0 0 0 0 0 0 0 0 0 0
Innenzehner: 40
Weiteste: 171 (4.), 151 (38.), 148 (12.)
beste Teiler: 9.0 (36.), 16.4 (6.), 16.7 (14.)
Trefferlage: 0.17 mm links, 0.01 mm hoch
Streuwert: 0.60, horizontal: 0.70, vertikal: 0.47

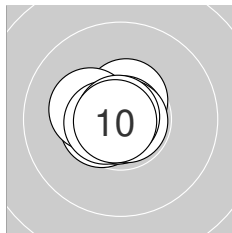
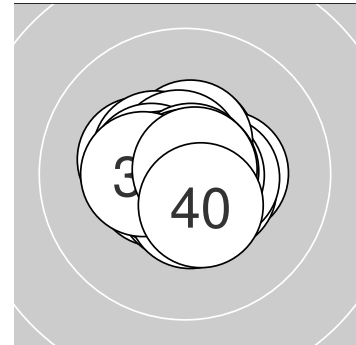

Serie 1: 106.7 (100)

10.6* ↘	10.5* ↑	10.5* ←	10.3* ←	10.8* ↙
10.9* ↗	10.8* ↘	10.6* ←	10.9* ↘	10.8* ↙

beste Teiler: 16.4 (6.), 19.1 (9.), 27.6 (5.)
Trefferlage: 0.42 mm links, 0.13 mm hoch
Streuwert: 0.54, horizontal: 0.63, vertikal: 0.43

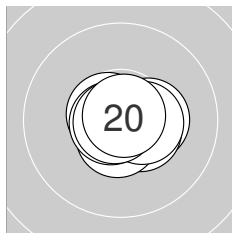

Serie 2: 106.5 (100)

10.7* →	10.4* →	10.5* ↘	10.9* ←	10.6* ↓
10.5* →	10.6* ↘	10.7* ←	10.8* ←	10.8* ↗

beste Teiler: 16.7 (14.), 30.0 (20.), 33.5 (19.)
Trefferlage: 0.26 mm rechts, 0.11 mm tief
Streuwert: 0.60, horizontal: 0.77, vertikal: 0.35

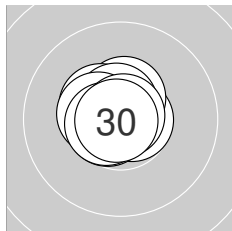

Serie 3: 106.4 (100)

10.7* →	10.7* ←	10.5* ↑	10.4* ↘	10.6* ↑
10.5* ←	10.6* ←	10.6* ←	10.9* ↗	10.9* ←

beste Teiler: 24.3 (30.), 24.4 (29.), 59.0 (22.)
Trefferlage: 0.38 mm links, 0.26 mm hoch
Streuwert: 0.54, horizontal: 0.59, vertikal: 0.48

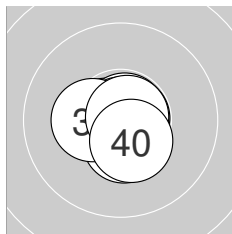

Serie 4: 106.6 (100)

10.8* ↓	10.8* →	10.6* ←	10.6* ←	10.8* ↗
10.9* ↑	10.5* ↓	10.3* ←	10.8* ↗	10.5* ↓

beste Teiler: 9.0 (36.), 37.2 (35.), 37.8 (31.)
Trefferlage: 0.13 mm links, 0.20 mm tief
Streuwert: 0.61, horizontal: 0.68, vertikal: 0.52



Ergebnis: **415.6** (395)
 Serien: 104.1 103.8 104.4 103.3
 Zähler: 35 5 0 0 0 0 0 0 0 0
 Innenzehner: 31
 Weitester: 327 (40.), 317 (16.), 290 (39.)
 beste Teiler: 16.0 (12.), 24.2 (26.), 24.6 (25.)
 Trefferlage: 0.07 mm links, 0.08 mm tief
 Streuwert: 1.17, horizontal: 1.20, vertikal: 1.14

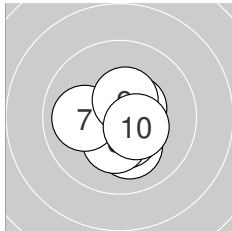
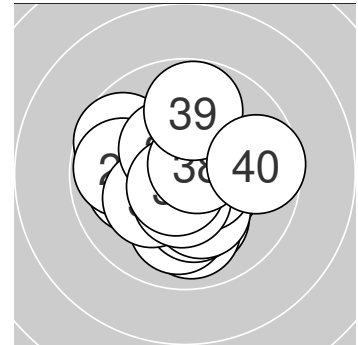

Serie 1: 104.1 (100)

10.7* ↗	10.6* ←	10.1 ↓	10.6* ↓	10.4* ↓
10.3* ↓	10.0 ←	10.5* ↗	10.5* ↑	10.4* ↘

beste Teiler: 73.2 (1.), 76.0 (4.), 97.0 (2.)
 Trefferlage: 0.08 mm rechts, 0.39 mm tief
 Streuwert: 1.03, horizontal: 1.05, vertikal: 1.01

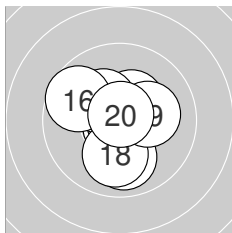

Serie 2: 103.8 (98)

10.8* ↗	10.9* ↓	10.4* ↗	10.3* ↘	9.9 ↓
9.7 ↖	10.8* →	10.0 ↓	10.2* →	10.8* ↑

beste Teiler: 16.0 (12.), 36.1 (17.), 40.7 (20.)
 Trefferlage: 0.10 mm links, 0.05 mm tief
 Streuwert: 1.31, horizontal: 1.24, vertikal: 1.39

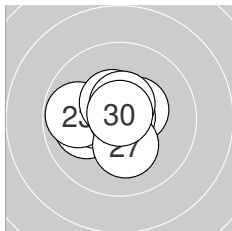

Serie 3: 104.4 (99)

10.0 ←	10.4* ←	9.8 ←	10.4* ↗	10.9* ↑
10.9* ↗	10.2* ↓	10.5* ↘	10.5* ↑	10.8* ↑

beste Teiler: 24.2 (26.), 24.6 (25.), 40.0 (30.)
 Trefferlage: 0.50 mm links, 0.19 mm hoch
 Streuwert: 1.07, horizontal: 1.26, vertikal: 0.82

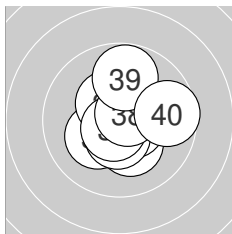

Serie 4: 103.3 (98)

10.3* ↓	10.6* ↘	10.5* ↗	10.2* ↗	10.5* ↓
10.4* ↘	10.7* ↗	10.7* ↗	9.8 ↑	9.6 →

beste Teiler: 69.4 (37.), 71.7 (38.), 93.2 (32.)
 Trefferlage: 0.22 mm rechts, 0.06 mm tief
 Streuwert: 1.32, horizontal: 1.30, vertikal: 1.34



LG 40 AUT Senioren

StandNr: 45

Ranalter, Martin #245

Männer

Wertung

StartNr: 249

21.03.2024 14:07

T – SG Schwaz

Ergebnis: **413.9** (396)
 Serien: 104.1 103.6 103.4 102.8
 Zähler: 36 4 0 0 0 0 0 0 0 0
 Innenzehner: 32
 Weitestе: 486 (37.), 350 (7.), 346 (23.)
 beste Teiler: 11.4 (39.), 29.6 (34.), 33.9 (29.)
 Trefferlage: 0.46 mm rechts, 0.05 mm hoch
 Streuwert: 1.24, horizontal: 1.57, vertikal: 0.78

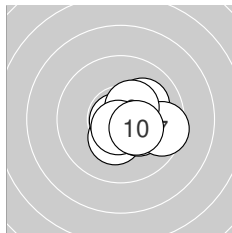
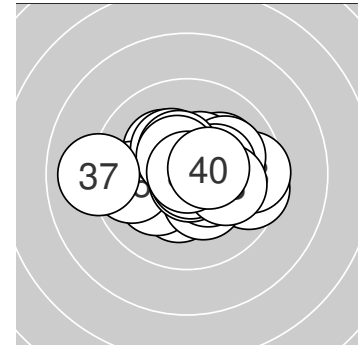

Serie 1: 104.1 (99)

10.7* →	10.3* ↓	10.1 ↗	10.8* ↓	10.8* ←
10.3* ↘	9.6 →	10.4* ↗	10.7* ↓	10.4* ↘

beste Teiler: 34.4 (5.), 47.4 (4.), 61.0 (1.)
 Trefferlage: 0.87 mm rechts, 0.28 mm tief
 Streuwert: 1.03, horizontal: 1.19, vertikal: 0.83

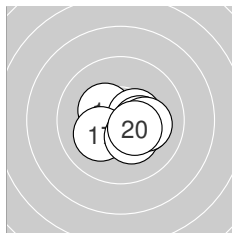

Serie 2: 103.6 (100)

10.7* ↓	10.2* →	10.6* ↘	10.3* ↘	10.5* →
10.3* →	10.2* ↗	10.3* ↓	10.1 →	10.4* ↘

beste Teiler: 61.7 (11.), 92.9 (13.), 122.1 (15.)
 Trefferlage: 0.62 mm rechts, 0.40 mm tief
 Streuwert: 1.01, horizontal: 1.28, vertikal: 0.63

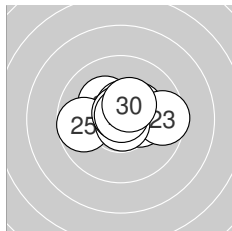

Serie 3: 103.4 (98)

10.3* ↗	10.3* →	9.6 →	10.2* ↘	9.7 ←
10.8* ↓	10.6* ↑	10.7* ↑	10.8* ↑	10.4* ↗

beste Teiler: 33.9 (29.), 41.2 (26.), 51.6 (28.)
 Trefferlage: 0.30 mm rechts, 0.42 mm hoch
 Streuwert: 1.30, horizontal: 1.72, vertikal: 0.63

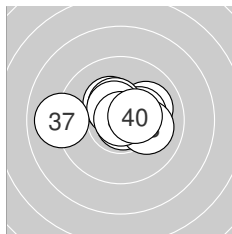

Serie 4: 102.8 (99)

10.0 ↗	10.3* ↘	10.3* →	10.8* ↓	10.4* ↑
10.5* ↘	9.0 ←	10.1 →	10.9* ↑	10.5* →

beste Teiler: 11.4 (39.), 29.6 (34.), 111.8 (36.)
 Trefferlage: 0.04 mm rechts, 0.46 mm hoch
 Streuwert: 1.52, horizontal: 2.04, vertikal: 0.65



LG 40 AUT Senioren

StandNr: 46

Polleres-Vogler, Niklas #246

Männer

Wertung

StartNr: 250

21.03.2024 13:50

B – SSV Rohrbach

Ergebnis: **411.9** (393)
 Serien: 102.6 102.4 105.5 101.4
 Zähler: 33 7 0 0 0 0 0 0 0 0
 Innenzehner: 24
 Weitesten: 364 (37.), 362 (9.), 343 (11.)
 beste Teiler: 18.3 (28.), 18.9 (36.), 59.0 (17.)
 Trefferlage: 0.78 mm rechts, 0.31 mm tief
 Streuwert: 1.22, horizontal: 1.49, vertikal: 0.88

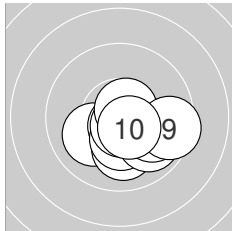
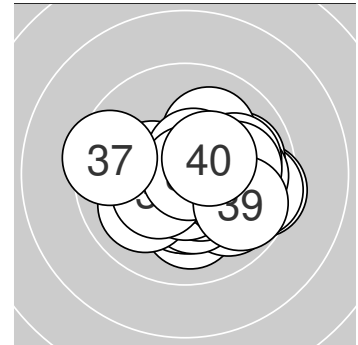

Serie 1: 102.6 (98)

10.1 ↖	10.1 ↓	10.7* ↓	10.3* ↓	9.9 ↘
10.7* ↓	10.0 ↘	10.7* ↗	9.5 →	10.6* ↘

beste Teiler: 62.0 (3.), 62.0 (6.), 69.5 (8.)
 Trefferlage: 0.77 mm rechts, 0.97 mm tief
 Streuwert: 1.19, horizontal: 1.50, vertikal: 0.75

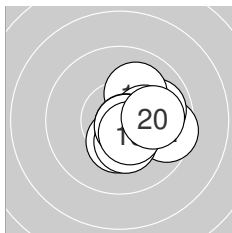

Serie 2: 102.4 (98)

9.6 →	10.4* ↓	10.3* ↓	9.9 →	10.1 ↗
10.2* →	10.7* ↘	10.7* ↘	10.5* ↘	10.0 →

beste Teiler: 59.0 (17.), 60.8 (18.), 118.0 (19.)
 Trefferlage: 1.30 mm rechts, 0.24 mm tief
 Streuwert: 1.09, horizontal: 1.13, vertikal: 1.05

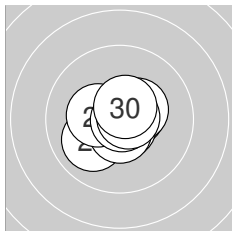

Serie 3: 105.5 (100)

10.6* →	10.0 ↖	10.7* ↘	10.6* ↓	10.7* ↗
10.4* →	10.3* ↖	10.9* ↘	10.7* →	10.6* ↗

beste Teiler: 18.3 (28.), 62.3 (29.), 63.5 (25.)
 Trefferlage: 0.06 mm rechts, 0.01 mm tief
 Streuwert: 0.88, horizontal: 1.00, vertikal: 0.74

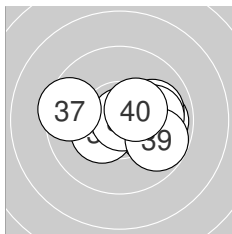

Serie 4: 101.4 (97)

10.1 →	9.9 →	10.0 →	10.4* →	10.4* ↖
10.9* →	9.5 ↖	10.0 →	9.8 ↘	10.4* ↗

beste Teiler: 18.9 (36.), 136.7 (40.), 137.1 (34.)
 Trefferlage: 0.99 mm rechts, 0.04 mm tief
 Streuwert: 1.52, horizontal: 2.02, vertikal: 0.72



Ergebnis: 413.9 (397)
Serien: 103.9 103.3 102.4 104.3
Zähler: 37 3 0 0 0 0 0 0 0 0 0
Innenzehner: 32
Weiteste: 414 (24.), 331 (29.), 280 (18.)
beste Teiler: 47.8 (36.), 54.8 (21.), 59.2 (38.)
Trefferlage: 0.60 mm rechts, 0.15 mm hoch
Streuwert: 1.12, horizontal: 1.30, vertikal: 0.91

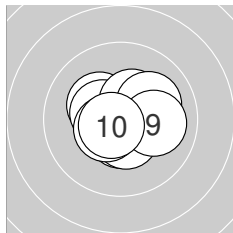
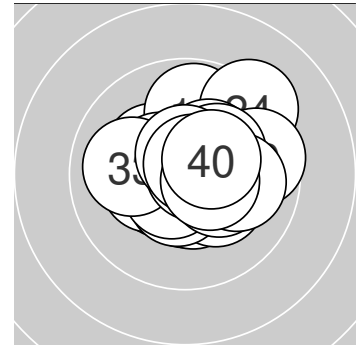

Serie 1: 103.9 (100)

10.5* ↓	10.5* ↓	10.5* →	10.3* ↖	10.4* ↖
10.5* ↙	10.4* ↗	10.1 ↗	10.0 →	10.7* ↘

beste Teiler: 75.7 (10.), 109.0 (1.), 115.9 (6.)
Trefferlage: 0.22 mm rechts, 0.01 mm hoch
Streuwert: 1.10, horizontal: 1.30, vertikal: 0.86

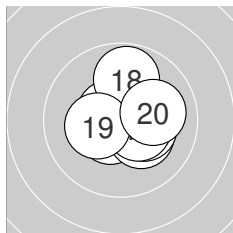

Serie 2: 103.3 (99)

10.6* ↖	10.5* ↙	10.6* →	10.3* ↘	10.5* →
10.3* →	10.4* ↘	9.8 ↑	10.3* ←	10.0 →

beste Teiler: 87.6 (11.), 89.2 (13.), 102.6 (12.)
Trefferlage: 0.58 mm rechts, 0.03 mm hoch
Streuwert: 1.15, horizontal: 1.21, vertikal: 1.09

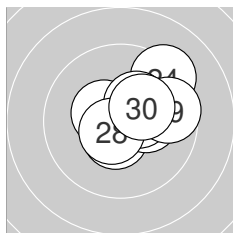

Serie 3: 102.4 (98)

10.7* ↙	10.5* ↓	10.3* →	9.3 ↗	10.4* ↖
10.3* ↗	10.4* →	10.6* ↘	9.6 →	10.3* ↗

beste Teiler: 54.8 (21.), 91.4 (28.), 108.4 (22.)
Trefferlage: 0.91 mm rechts, 0.48 mm hoch
Streuwert: 1.33, horizontal: 1.50, vertikal: 1.13

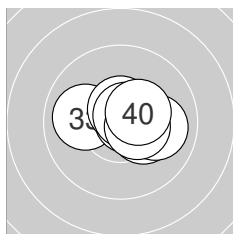

Serie 4: 104.3 (100)

10.3* ↘	10.5* →	10.0 ←	10.5* →	10.0 →
10.8* →	10.6* ↑	10.7* ↗	10.5* →	10.4* ↗

beste Teiler: 47.8 (36.), 59.2 (38.), 90.0 (37.)
Trefferlage: 0.69 mm rechts, 0.10 mm hoch
Streuwert: 0.96, horizontal: 1.27, vertikal: 0.49



Ergebnis: **422.3** (400)
 Serien: 104.9 105.2 106.4 105.8
 Zähler: 40 0 0 0 0 0 0 0 0 0 0
 Innenzehner: 37
 Weitesten: 239 (4.), 203 (10.), 201 (2.)
 beste Teiler: 5.6 (5.), 18.0 (6.), 19.6 (26.)
 Trefferlage: 0.19 mm links, 0.15 mm tief
 Streuwert: 0.80, horizontal: 0.77, vertikal: 0.83

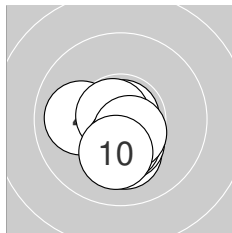
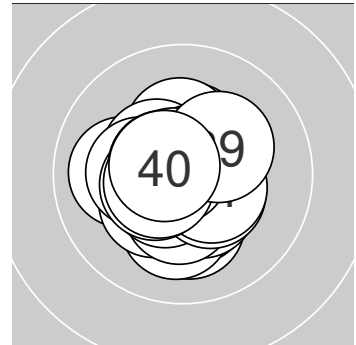

Serie 1: 104.9 (100)

10.8* ↖	10.1 ↓	10.4* ↓	10.0 ←	10.9* ↗
10.9* ↗	10.7* ↖	10.4* ↓	10.6* ↘	10.1 ↓

beste Teiler: 5.6 (5.), 18.0 (6.), 43.4 (1.)
 Trefferlage: 0.20 mm links, 0.70 mm tief
 Streuwert: 0.89, horizontal: 0.84, vertikal: 0.94

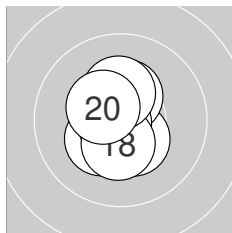

Serie 2: 105.2 (100)

10.7* ↓	10.7* ↑	10.4* ↘	10.4* ↑	10.8* ↖
10.3* ↗	10.8* ↖	10.4* ↓	10.3* ↑	10.4* ↖

beste Teiler: 40.7 (17.), 49.1 (15.), 58.8 (11.)
 Trefferlage: 0.23 mm links, 0.04 mm hoch
 Streuwert: 0.88, horizontal: 0.58, vertikal: 1.10

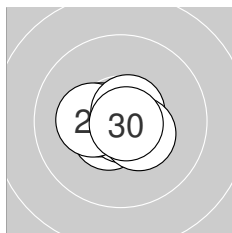

Serie 3: 106.4 (100)

10.5* ↗	10.5* ←	10.8* ↖	10.8* ↓	10.7* ↗
10.9* ↑	10.3* ←	10.7* ↗	10.4* ↘	10.8* ↘

beste Teiler: 19.6 (26.), 26.4 (23.), 32.2 (24.)
 Trefferlage: 0.13 mm links, 0.04 mm tief
 Streuwert: 0.68, horizontal: 0.85, vertikal: 0.44

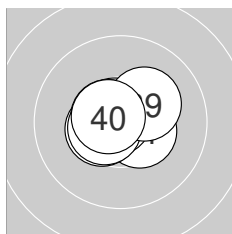

Serie 4: 105.8 (100)

10.7* ↖	10.7* ←	10.8* ↘	10.4* ↘	10.5* ←
10.6* ↖	10.8* ↖	10.5* ←	10.2* ↗	10.6* ↖

beste Teiler: 38.0 (33.), 41.6 (37.), 57.3 (31.)
 Trefferlage: 0.20 mm links, 0.08 mm hoch
 Streuwert: 0.72, horizontal: 0.89, vertikal: 0.50



LG 40 AUT Senioren

StandNr: 49

Hasler, Franz #249

Männer

Wertung

ST – SV 1582 Oberzeiring / Steiermark 1

StartNr: 253

21.03.2024 13:59

Ergebnis: **421.7** (399)
 Serien: 105.6 105.6 104.8 105.7
 Zähler: 39 1 0 0 0 0 0 0 0 0
 Innenzehner: 39
 Weitestе: 267 (29.), 182 (23.), 181 (32.)
 beste Teiler: 9.2 (22.), 19.2 (7.), 20.0 (16.)
 Trefferlage: 0.19 mm rechts, 0.36 mm hoch
 Streuwert: 0.81, horizontal: 0.75, vertikal: 0.86

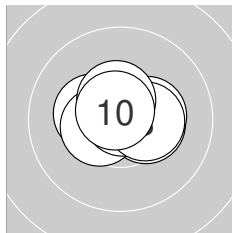
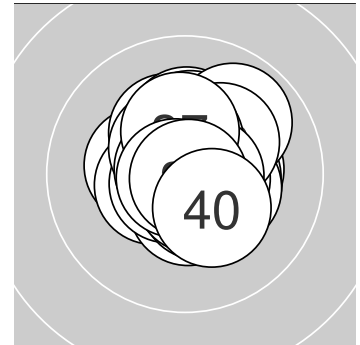

Serie 1: 105.6 (100)

10.3* ←	10.8* ↗	10.9* ↗	10.4* →	10.3* →
10.4* ←	10.9* ↗	10.4* →	10.5* ↑	10.7* ↘

beste Teiler: 19.2 (7.), 23.3 (3.), 47.4 (2.)
 Trefferlage: 0.16 mm rechts, 0.18 mm hoch
 Streuwert: 0.81, horizontal: 1.07, vertikal: 0.42

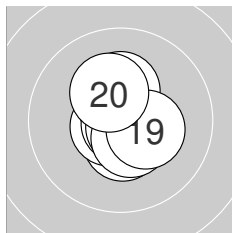

Serie 2: 105.6 (100)

10.7* ↘	10.5* ↓	10.7* ←	10.6* ↑	10.3* ↑
10.9* ↓	10.8* ↘	10.5* ↓	10.3* →	10.3* ↑

beste Teiler: 20.0 (16.), 46.0 (17.), 54.4 (11.)
 Trefferlage: 0.05 mm rechts, 0.07 mm hoch
 Streuwert: 0.83, horizontal: 0.61, vertikal: 1.01

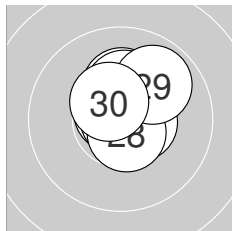

Serie 3: 104.8 (99)

10.7* ↘	10.9* ↘	10.2* ↑	10.6* →	10.4* ↑
10.3* ↑	10.7* ↗	10.6* ↓	9.9 ↗	10.5* ↘

beste Teiler: 9.2 (22.), 55.2 (21.), 56.0 (27.)
 Trefferlage: 0.27 mm rechts, 0.78 mm hoch
 Streuwert: 0.82, horizontal: 0.70, vertikal: 0.93

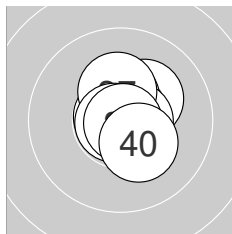

Serie 4: 105.7 (100)

10.4* ↗	10.2* ↗	10.5* ↑	10.7* →	10.8* ↘
10.8* ←	10.3* ↑	10.8* ←	10.9* ↘	10.3* ↘

beste Teiler: 22.0 (39.), 26.9 (35.), 39.0 (38.)
 Trefferlage: 0.27 mm rechts, 0.40 mm hoch
 Streuwert: 0.77, horizontal: 0.62, vertikal: 0.90



Ergebnis: 410.5 (390)
Serien: 101.0 101.6 103.0 104.9
Zähler: 30 10 0 0 0 0 0 0 0 0
Innenzehner: 27
Weiteste: 429 (17.), 357 (3.), 311 (12.)
beste Teiler: 11.1 (31.), 34.9 (10.), 36.0 (28.)
Trefferlage: 0.88 mm rechts, 0.46 mm tief
Streuwert: 1.21, horizontal: 1.11, vertikal: 1.29

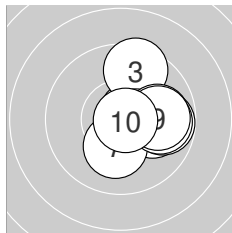
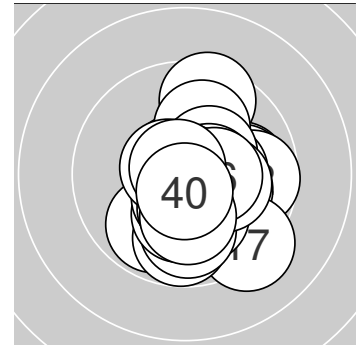

Serie 1: 101.0 (95)

10.6* ↗	10.0 →	9.5 ↑	10.5* →	9.9 →
9.8 →	10.2* ↓	9.8 →	9.9 →	10.8* →

beste Teiler: 34.9 (10.), 89.9 (1.), 105.8 (4.)
Trefferlage: 1.59 mm rechts, 0.11 mm hoch
Streuwert: 1.24, horizontal: 1.16, vertikal: 1.32

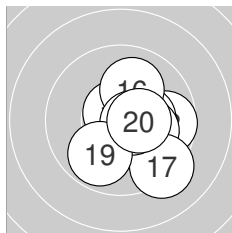

Serie 2: 101.6 (97)

10.6* →	9.7 →	10.3* →	10.7* ↘	10.2* →
10.0 ↑	9.2 ↘	10.6* →	9.9 ↙	10.4* →

beste Teiler: 65.8 (14.), 82.2 (18.), 98.3 (11.)
Trefferlage: 1.14 mm rechts, 0.38 mm tief
Streuwert: 1.42, horizontal: 1.37, vertikal: 1.48

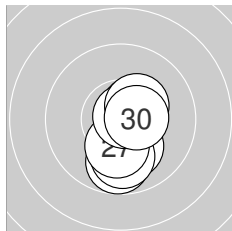

Serie 3: 103.0 (98)

10.3* ↓	9.8 ↓	10.5* ↓	10.5* ↗	10.1 ↓
9.9 ↓	10.2* ↓	10.8* ↗	10.4* ↗	10.5* →

beste Teiler: 36.0 (28.), 111.4 (30.), 115.8 (24.)
Trefferlage: 0.47 mm rechts, 1.00 mm tief
Streuwert: 1.05, horizontal: 0.50, vertikal: 1.40

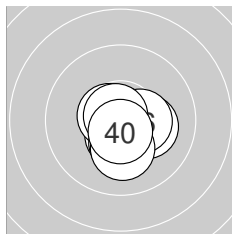

Serie 4: 104.9 (100)

10.9* ↑	10.5* ↓	10.4* →	10.2* →	10.6* ↖
10.4* →	10.8* ↖	10.3* ↓	10.2* ↓	10.6* ↓

beste Teiler: 11.1 (31.), 46.0 (37.), 80.0 (40.)
Trefferlage: 0.31 mm rechts, 0.56 mm tief
Streuwert: 0.81, horizontal: 0.85, vertikal: 0.78



LG 40 AUT Senioren

StandNr: 51

Mair, Gerhard #251

Männer

Wertung

StartNr: 255

21.03.2024 13:56

T – SG Matri a. B.

Ergebnis: **419.4** (399)
 Serien: 104.2 105.4 103.9 105.9
 Zähler: 39 1 0 0 0 0 0 0 0 0
 Innenzehner: 36
 Weitesten: 274 (27.), 219 (22.), 214 (2.)
 beste Teiler: 36.3 (31.), 37.9 (38.), 46.6 (32.)
 Trefferlage: 0.31 mm links, 0.26 mm hoch
 Streuwert: 0.88, horizontal: 0.96, vertikal: 0.80

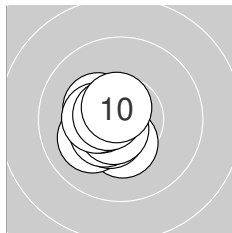
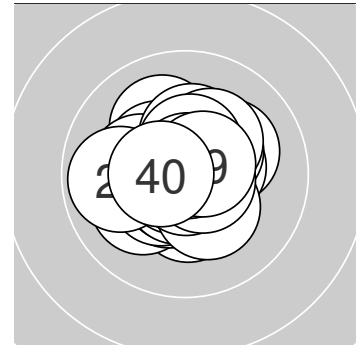

Serie 1: 104.2 (100)

10.4* ↓	10.1 ↙	10.5* ↘	10.4* ↙	10.6* ↘
10.3* ↖	10.4* ←	10.3* ←	10.6* ↖	10.6* ↗

beste Teiler: 78.2 (5.), 79.3 (10.), 85.0 (9.)
 Trefferlage: 0.91 mm links, 0.31 mm tief
 Streuwert: 0.71, horizontal: 0.61, vertikal: 0.79

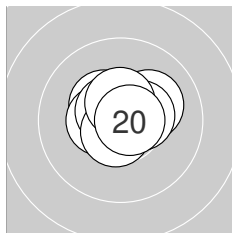

Serie 2: 105.4 (100)

10.1 ↗	10.5* →	10.4* ↘	10.8* ↘	10.7* ↑
10.5* ←	10.6* ↘	10.6* ↘	10.5* ↑	10.7* →

beste Teiler: 49.6 (14.), 58.0 (20.), 73.3 (15.)
 Trefferlage: 0.00 mm, 0.43 mm hoch
 Streuwert: 0.79, horizontal: 0.96, vertikal: 0.57

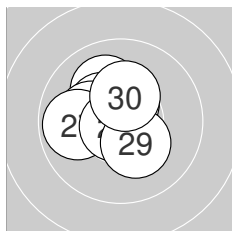

Serie 3: 103.9 (99)

10.7* ↘	10.1 ↘	10.7* ↘	10.4* ↘	10.2* ←
10.5* ↑	9.9 ←	10.8* ↘	10.3* ↘	10.3* ↑

beste Teiler: 49.8 (28.), 62.9 (21.), 75.9 (23.)
 Trefferlage: 0.65 mm links, 0.49 mm hoch
 Streuwert: 1.03, horizontal: 1.08, vertikal: 0.98

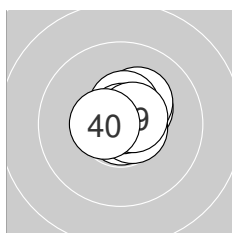

Serie 4: 105.9 (100)

10.8* ↓	10.8* ↘	10.4* ↘	10.7* ↘	10.6* →
10.2* ↗	10.5* ↑	10.8* ↑	10.6* ↗	10.5* ←

beste Teiler: 36.3 (31.), 37.9 (38.), 46.6 (32.)
 Trefferlage: 0.32 mm rechts, 0.45 mm hoch
 Streuwert: 0.62, horizontal: 0.65, vertikal: 0.59



LG 40 AUT Senioren

StandNr: 52

Steindl, Niklas #252

Männer

Wertung

StartNr: 256

21.03.2024 13:54

B – SSV Breitenbrunn

Ergebnis: **414.7** (394)
 Serien: 104.5 104.8 103.1 102.3
 Zähler: 34 6 0 0 0 0 0 0 0 0
 Innenzehner: 29
 Weitesten: 410 (28.), 292 (34.), 284 (3.)
 beste Teiler: 6.0 (2.), 42.5 (20.), 50.2 (38.)
 Trefferlage: 0.36 mm rechts, 0.06 mm tief
 Streuwert: 1.21, horizontal: 1.21, vertikal: 1.21

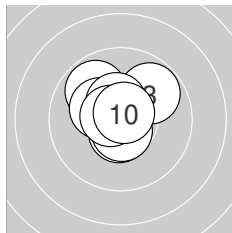
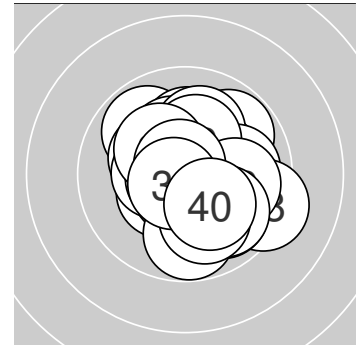

Serie 1: 104.5 (98)

10.6* ↓	10.9* →	9.8 ↗	9.8 ↖	10.7* ↖
10.6* ↓	10.3* ↖	10.5* ↑	10.6* ↖	10.7* ↗

beste Teiler: 6.0 (2.), 52.7 (10.), 53.8 (5.)
 Trefferlage: 0.22 mm links, 0.53 mm hoch
 Streuwert: 1.04, horizontal: 1.08, vertikal: 1.01

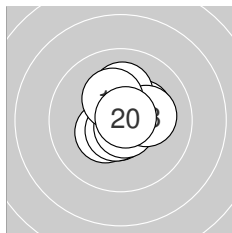

Serie 2: 104.8 (100)

10.7* ↓	10.4* ↙	10.7* ↗	10.3* →	10.6* ↓
10.1 ↑	10.7* ↘	10.2* →	10.3* ↖	10.8* ↗

beste Teiler: 42.5 (20.), 59.0 (17.), 66.6 (13.)
 Trefferlage: 0.22 mm rechts, 0.25 mm hoch
 Streuwert: 0.95, horizontal: 0.91, vertikal: 1.00

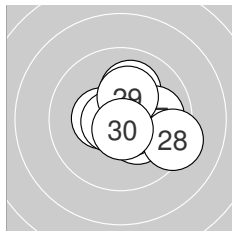

Serie 3: 103.1 (99)

10.4* ←	10.3* ↘	10.1 ↑	10.7* →	10.7* ←
10.6* ↘	10.0 →	9.3 ↘	10.3* ↑	10.7* ↓

beste Teiler: 66.1 (24.), 69.3 (25.), 75.3 (30.)
 Trefferlage: 0.80 mm rechts, 0.02 mm tief
 Streuwert: 1.31, horizontal: 1.47, vertikal: 1.12

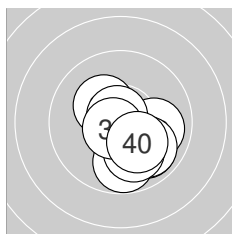

Serie 4: 102.3 (97)

10.7* ↓	10.0 →	9.9 ↘	9.8 ↓	9.9 ↘
10.0 ↓	10.3* ↖	10.8* ↖	10.7* ↙	10.2* ↘

beste Teiler: 50.2 (38.), 67.6 (31.), 71.7 (39.)
 Trefferlage: 0.63 mm rechts, 1.01 mm tief
 Streuwert: 1.24, horizontal: 1.21, vertikal: 1.26



Ergebnis: **412.8** (394)
 Serien: 103.5 103.3 103.2 102.8
 Zähler: 34 6 0 0 0 0 0 0 0 0
 Innenzehner: 28
 Weitestе: 340 (3.), 320 (31.), 312 (24.)
 beste Teiler: 15.2 (33.), 38.9 (40.), 50.9 (27.)
 Trefferlage: 0.54 mm rechts, 0.08 mm tief
 Streuwert: 1.22, horizontal: 1.51, vertikal: 0.83

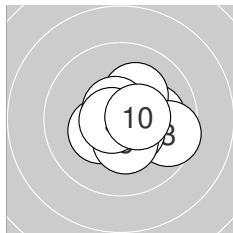
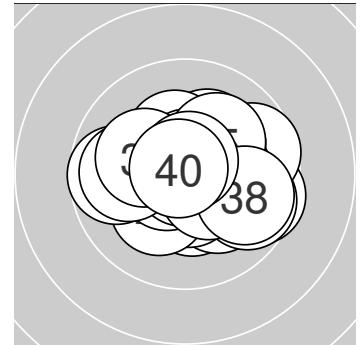

Serie 1: 103.5 (99)

10.1 →	10.2* ↗	9.6 →	10.3* ←	10.5* ↘
10.7* ↘	10.6* ↖	10.3* ↓	10.7* ←	10.5* →

beste Teiler: 60.5 (9.), 67.1 (6.), 77.8 (7.)
 Trefferlage: 0.67 mm rechts, 0.20 mm tief
 Streuwert: 1.15, horizontal: 1.35, vertikal: 0.91

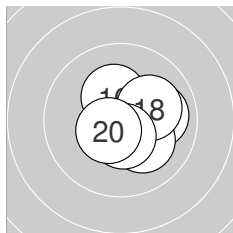

Serie 2: 103.3 (100)

10.1 →	10.6* ↓	10.0 →	10.5* →	10.6* ↘
10.3* ↖	10.1 ↘	10.1 →	10.5* ↓	10.5* ↗

beste Teiler: 86.9 (12.), 92.1 (15.), 108.4 (20.)
 Trefferlage: 0.80 mm rechts, 0.21 mm tief
 Streuwert: 1.05, horizontal: 1.14, vertikal: 0.95

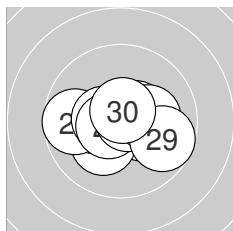

Serie 3: 103.2 (98)

10.5* ↗	10.3* →	10.2* ↖	9.7 ←	10.5* ←
10.6* ←	10.8* →	10.2* →	9.7 →	10.7* ↑

beste Teiler: 50.9 (27.), 74.3 (30.), 88.0 (26.)
 Trefferlage: 0.16 mm rechts, 0.17 mm tief
 Streuwert: 1.35, horizontal: 1.77, vertikal: 0.71

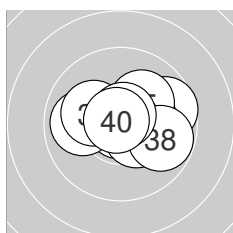

Serie 4: 102.8 (97)

9.7 →	10.3* →	10.9* ↖	9.9 ←	10.1 ↗
10.2* ←	10.4* ↘	9.8 →	10.7* ↑	10.8* ↖

beste Teiler: 15.2 (33.), 38.9 (40.), 63.6 (39.)
 Trefferlage: 0.54 mm rechts, 0.23 mm hoch
 Streuwert: 1.40, horizontal: 1.83, vertikal: 0.75

