

Ergebnis: 417.6 (398)
Serien: 102.7 104.7 105.8 104.4
Zähler: 38 2 0 0 0 0 0 0 0 0 0
Innenzehner: 32
Weiteste: 352 (8.), 277 (34.), 244 (20.)
beste Teiler: 14.0 (13.), 14.1 (28.), 24.8 (27.)
Trefferlage: 0.75 mm links, 0.10 mm tief
Streuwert: 0.93, horizontal: 1.17, vertikal: 0.61

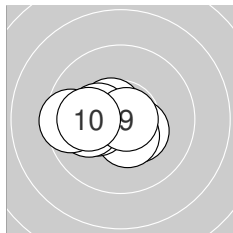
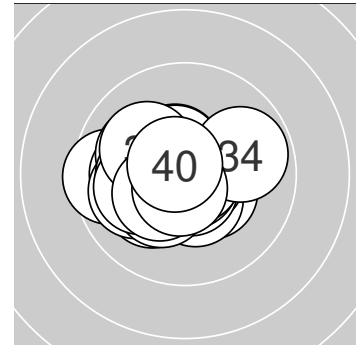

Serie 1: 102.7 (99)

10.4* ↘	10.4* ←	10.4* ↓	10.6* ↖	10.3* ←
10.3* ←	10.0 ←	9.5 ←	10.8* →	10.0 ←

beste Teiler: 41.0 (9.), 95.4 (4.), 127.2 (3.)
Trefferlage: 1.12 mm links, 0.18 mm tief
Streuwert: 1.10, horizontal: 1.46, vertikal: 0.53

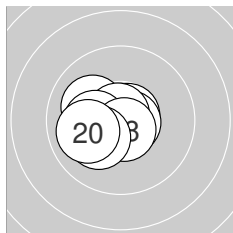

Serie 2: 104.7 (100)

10.1 ↖	10.7* ↗	10.9* ↑	10.7* →	10.4* ←
10.8* ↖	10.2* ←	10.7* ↓	10.2* ↗	10.0 ←

beste Teiler: 14.0 (13.), 42.9 (16.), 61.8 (14.)
Trefferlage: 0.77 mm links, 0.14 mm tief
Streuwert: 0.91, horizontal: 1.12, vertikal: 0.64

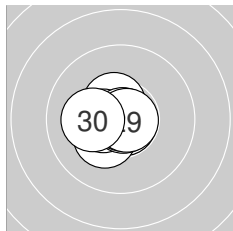

Serie 3: 105.8 (100)

10.5* ↖	10.8* ↘	10.4* ←	10.5* ↖	10.3* ↗
10.5* ←	10.9* ↘	10.9* →	10.8* →	10.2* ←

beste Teiler: 14.1 (28.), 24.8 (27.), 42.0 (22.)
Trefferlage: 0.61 mm links, 0.16 mm tief
Streuwert: 0.71, horizontal: 0.83, vertikal: 0.55

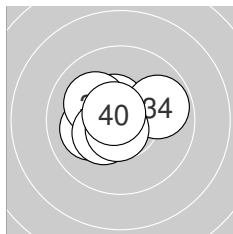

Serie 4: 104.4 (99)

10.1 ←	10.8* ↗	10.5* ↖	9.8 →	10.1 ↖
10.7* ↖	10.6* ↗	10.4* ↗	10.7* ↓	10.7* ↖

beste Teiler: 32.5 (32.), 51.8 (36.), 66.4 (40.)
Trefferlage: 0.50 mm links, 0.06 mm hoch
Streuwert: 1.04, horizontal: 1.26, vertikal: 0.76



Ergebnis: **411.8** (394)
 Serien: 102.5 105.0 101.8 102.5
 Zähler: 34 6 0 0 0 0 0 0 0 0
 Innenzehner: 24
 Weitesten: 452 (26.), 359 (32.), 328 (37.)
 beste Teiler: 13.6 (12.), 34.6 (14.), 38.2 (17.)
 Trefferlage: 0.31 mm links, 0.04 mm hoch
 Streuwert: 1.35, horizontal: 1.62, vertikal: 1.02

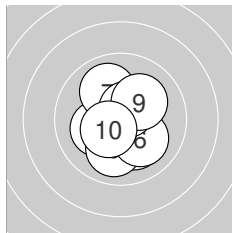
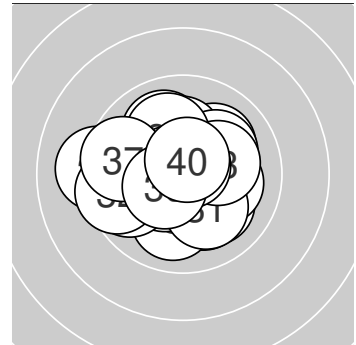

Serie 1: 102.5 (100)

10.6* →	10.3* ↙	10.2* ↙	10.1 ↘	10.0 ↓
10.1 ↘	10.0 ↗	10.6* ↗	10.1 ↗	10.5* ↙

beste Teiler: 94.0 (8.), 98.3 (1.), 124.9 (10.)
 Trefferlage: 0.01 mm links, 0.35 mm tief
 Streuwert: 1.36, horizontal: 1.28, vertikal: 1.44

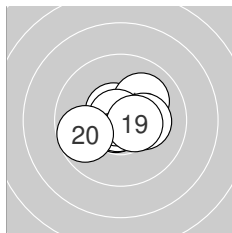

Serie 2: 105.0 (99)

10.8* ↙	10.9* ↑	10.6* ↗	10.8* ↙	10.6* ↗
10.1 ↗	10.8* ↘	10.2* →	10.5* →	9.7 ↙

beste Teiler: 13.6 (12.), 34.6 (14.), 38.2 (17.)
 Trefferlage: 0.10 mm rechts, 0.09 mm hoch
 Streuwert: 1.07, horizontal: 1.34, vertikal: 0.70

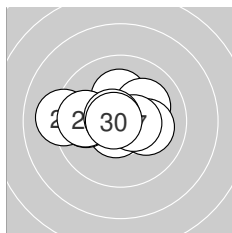

Serie 3: 101.8 (97)

10.7* ↙	10.2* ↑	9.9 ←	10.1 ↗	10.1 →
9.1 ←	10.5* →	9.8 ←	10.7* ↘	10.7* ↙

beste Teiler: 55.1 (30.), 73.4 (29.), 75.6 (21.)
 Trefferlage: 0.69 mm links, 0.27 mm hoch
 Streuwert: 1.58, horizontal: 2.11, vertikal: 0.75

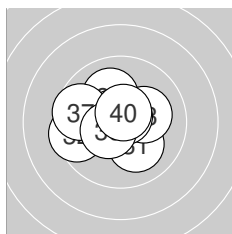

Serie 4: 102.5 (98)

10.1 ↘	9.5 ←	10.2* →	10.1 ↘	10.5* ↙
10.7* ↘	9.6 ←	10.7* ↗	10.5* ↙	10.6* ↑

beste Teiler: 52.1 (38.), 73.8 (36.), 79.1 (40.)
 Trefferlage: 0.65 mm links, 0.14 mm hoch
 Streuwert: 1.42, horizontal: 1.70, vertikal: 1.06



Ergebnis: 415.0 (396)
Serien: 105.0 103.9 103.0 103.1
Zähler: 36 4 0 0 0 0 0 0 0 0 0
Innenzehner: 29
Weiteste: 331 (37.), 324 (25.), 302 (19.)
beste Teiler: 21.9 (33.), 35.3 (17.), 42.1 (38.)
Trefferlage: 0.58 mm links, 0.27 mm tief
Streuwert: 1.11, horizontal: 1.14, vertikal: 1.08

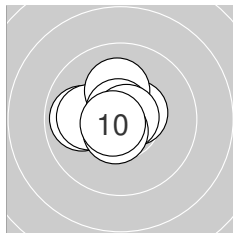
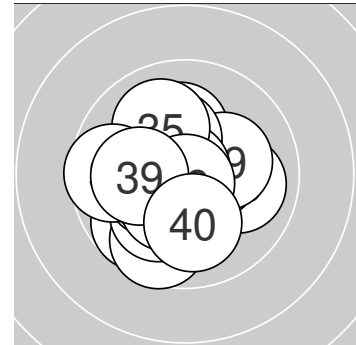

Serie 1: 105.0 (99)

10.7* ↘	10.8* ↑	10.5* →	9.9 ←	10.1 ←
10.2* ↑	10.7* ↗	10.8* →	10.6* ↓	10.7* ↘

beste Teiler: 42.7 (8.), 45.0 (2.), 56.3 (7.)
Trefferlage: 0.49 mm links, 0.31 mm hoch
Streuwert: 0.93, horizontal: 1.11, vertikal: 0.72

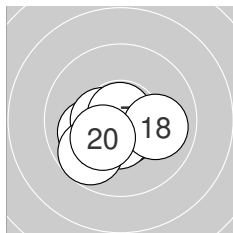

Serie 2: 103.9 (99)

10.1 ←	10.6* ↓	10.7* ←	10.7* ↘	10.5* ←
10.5* ↓	10.8* ↑	10.0 →	9.7 ↘	10.3* ↘

beste Teiler: 35.3 (17.), 69.4 (14.), 73.2 (13.)
Trefferlage: 0.54 mm links, 0.65 mm tief
Streuwert: 1.07, horizontal: 1.31, vertikal: 0.74

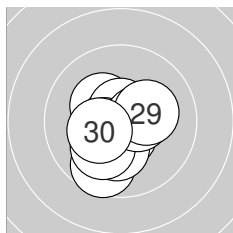

Serie 3: 103.0 (99)

10.6* ↓	10.3* ↘	10.7* ↑	10.4* ↘	9.7 ↓
10.2* ↓	10.1 ↗	10.5* →	10.2* →	10.3* ↘

beste Teiler: 71.0 (23.), 98.2 (21.), 117.9 (28.)
Trefferlage: 0.33 mm links, 0.63 mm tief
Streuwert: 1.22, horizontal: 1.12, vertikal: 1.31

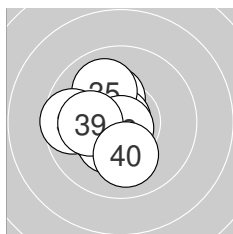

Serie 4: 103.1 (99)

10.3* ↗	10.4* ←	10.9* ↘	10.6* ↘	10.0 ↘
10.3* ↘	9.6 ←	10.8* ↓	10.1 ←	10.1 ↓

beste Teiler: 21.9 (33.), 42.1 (38.), 83.0 (34.)
Trefferlage: 0.96 mm links, 0.11 mm tief
Streuwert: 1.18, horizontal: 1.09, vertikal: 1.26



Ergebnis: 399.3 (380)
Serien: 100.6 98.9 97.6 102.2
Zähler: 22 16 2 0 0 0 0 0 0 0
Innenzehner: 19
Weiteste: 517 (27.), 508 (18.), 493 (11.)
beste Teiler: 12.1 (38.), 38.9 (33.), 56.9 (16.)
Trefferlage: 0.14 mm rechts, 0.07 mm hoch
Streuwert: 1.99, horizontal: 2.52, vertikal: 1.27

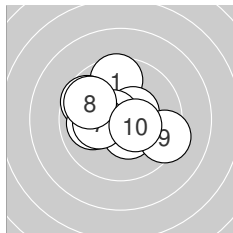
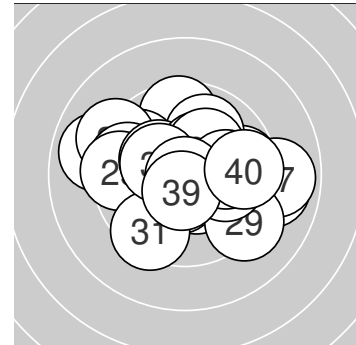

Serie 1: 100.6 (96)

9.6 ↑	10.4* ↘	9.7 ↖	10.5* →	10.7* ↖
10.0 ←	10.2* ←	9.8 ↖	9.3 →	10.4* →

beste Teiler: 69.0 (5.), 118.5 (4.), 132.5 (2.)
Trefferlage: 0.39 mm links, 0.32 mm hoch
Streuwert: 1.81, horizontal: 2.12, vertikal: 1.44

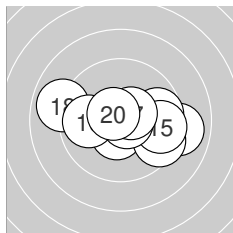

Serie 2: 98.9 (93)

9.0 →	10.5* ↓	9.5 ↘	9.7 →	9.6 →
10.7* →	10.5* ↗	8.9 ↖	9.9 ←	10.6* ↖

beste Teiler: 56.9 (16.), 82.2 (20.), 105.9 (17.)
Trefferlage: 0.75 mm rechts, 0.15 mm tief
Streuwert: 2.25, horizontal: 3.05, vertikal: 0.91

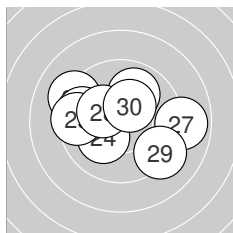

Serie 3: 97.6 (93)

10.5* ↖	9.2 ↖	9.6 ←	10.2* ↙	9.5 ←
9.9 ↗	8.9 →	10.3* ↖	9.2 ↘	10.3* ↗

beste Teiler: 114.9 (21.), 151.9 (30.), 171.4 (28.)
Trefferlage: 0.45 mm links, 0.34 mm hoch
Streuwert: 2.40, horizontal: 3.04, vertikal: 1.50

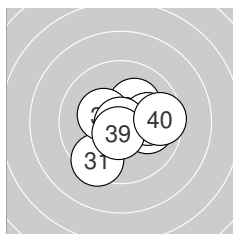

Serie 4: 102.2 (98)

9.4 ↙	10.4* →	10.8* ↙	10.0 →	10.2* ↗
10.0 →	10.3* ↖	10.9* ↓	10.6* ↓	9.6 →

beste Teiler: 12.1 (38.), 38.9 (33.), 95.9 (39.)
Trefferlage: 0.66 mm rechts, 0.19 mm tief
Streuwert: 1.51, horizontal: 1.73, vertikal: 1.25



Ergebnis: 415.8 (396)
Serien: 102.9 103.9 104.0 105.0
Zähler: 36 4 0 0 0 0 0 0 0 0 0
Innenzehner: 34
Weiteste: 459 (17.), 395 (4.), 318 (26.)
beste Teiler: 13.0 (14.), 14.1 (31.), 25.4 (34.)
Trefferlage: 0.13 mm rechts, 0.21 mm tief
Streuwert: 1.19, horizontal: 1.38, vertikal: 0.97

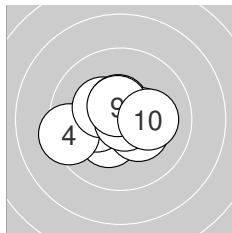
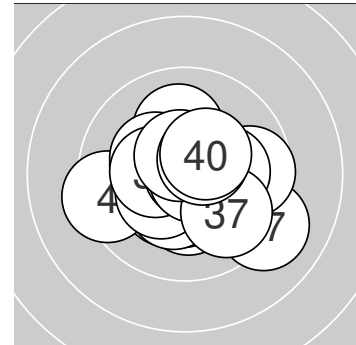

Serie 1: 102.9 (99)

10.3* ↙	10.3* ↘	10.2* ←	9.4 ←	10.3* ↖
10.5* ↑	10.4* →	10.8* →	10.6* ↑	10.1 →

beste Teiler: 31.6 (8.), 99.6 (9.), 105.3 (6.)
Trefferlage: 0.31 mm links, 0.05 mm tief
Streuwert: 1.37, horizontal: 1.74, vertikal: 0.85

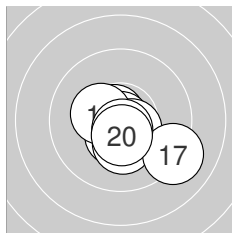

Serie 2: 103.9 (99)

10.4* ↓	10.7* ↖	10.5* ↓	10.9* ↓	10.5* ↘
10.3* ↓	9.1 ↘	10.3* ↖	10.7* ↓	10.5* ↓

beste Teiler: 13.0 (14.), 60.4 (12.), 70.0 (19.)
Trefferlage: 0.31 mm rechts, 0.83 mm tief
Streuwert: 1.17, horizontal: 1.39, vertikal: 0.92

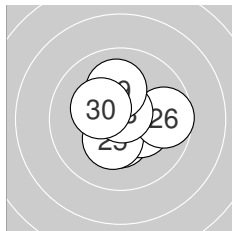

Serie 3: 104.0 (99)

10.8* ↙	10.4* ↓	10.7* ↙	10.3* ↘	10.3* ↓
9.7 →	10.7* ↑	10.7* ↑	10.1 ↑	10.3* ↖

beste Teiler: 49.6 (21.), 51.6 (28.), 65.1 (27.)
Trefferlage: 0.13 mm rechts, 0.00 mm
Streuwert: 1.19, horizontal: 1.29, vertikal: 1.09

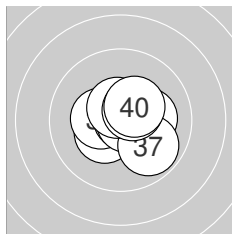

Serie 4: 105.0 (99)

10.9* →	10.4* ↙	10.4* ←	10.9* ↗	10.2* →
10.8* →	9.9 ↘	10.6* ↑	10.5* ↗	10.4* ↗

beste Teiler: 14.1 (31.), 25.4 (34.), 47.8 (36.)
Trefferlage: 0.38 mm rechts, 0.01 mm hoch
Streuwert: 1.02, horizontal: 1.16, vertikal: 0.86



Ergebnis: 405.8 (388)
Serien: 97.1 102.5 102.2 104.0
Zähler: 28 12 0 0 0 0 0 0 0 0
Innenzehner: 22
Weiteste: 440 (3.), 416 (4.), 399 (1.)
beste Teiler: 19.2 (40.), 34.4 (15.), 41.8 (22.)
Trefferlage: 0.78 mm links, 0.40 mm tief
Streuwert: 1.55, horizontal: 1.61, vertikal: 1.49

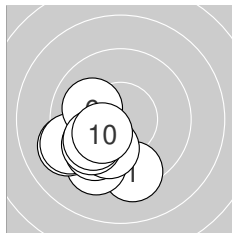
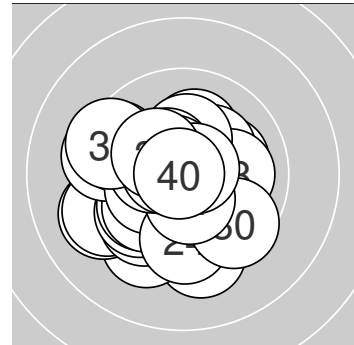

Serie 1: 97.1 (93)

9.4 ↓	9.4 ↙	9.2 ↙	9.3 ↙	9.8 ↙
10.0 ↖	10.0 ↙	9.8 ↙	9.9 ↙	10.3* ↙

beste Teiler: 171.4 (10.), 226.3 (6.), 233.4 (7.)
Trefferlage: 1.90 mm links, 1.91 mm tief
Streuwert: 1.32, horizontal: 1.37, vertikal: 1.28

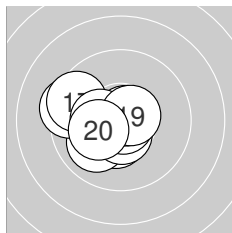

Serie 2: 102.5 (98)

10.4* ↓	10.0 ↙	10.5* ↓	9.4 ↖	10.8* ↘
10.8* ↗	9.5 ↖	10.3* ←	10.6* ↗	10.2* ↙

beste Teiler: 34.4 (15.), 48.1 (16.), 81.8 (19.)
Trefferlage: 1.09 mm links, 0.19 mm tief
Streuwert: 1.31, horizontal: 1.56, vertikal: 0.98

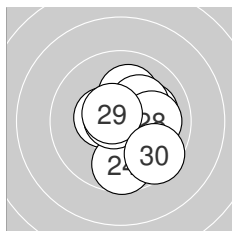

Serie 3: 102.2 (98)

10.1 ↑	10.8* ↖	10.4* ←	9.7 ↓	10.1 →
10.2* ↗	10.7* ↖	10.0 →	10.6* ↖	9.6 ↘

beste Teiler: 41.8 (22.), 54.4 (27.), 84.2 (29.)
Trefferlage: 0.61 mm rechts, 0.05 mm tief
Streuwert: 1.47, horizontal: 1.36, vertikal: 1.57

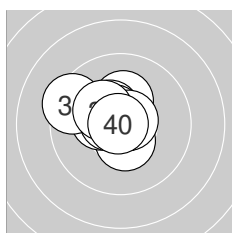

Serie 4: 104.0 (99)

10.4* ↓	10.3* ↑	10.4* ←	9.4 ↖	10.6* ←
10.4* ↖	10.6* ↖	10.7* ↗	10.3* ↖	10.9* ←

beste Teiler: 19.2 (40.), 61.7 (38.), 85.7 (35.)
Trefferlage: 0.76 mm links, 0.56 mm hoch
Streuwert: 1.04, horizontal: 1.20, vertikal: 0.85



Ergebnis: **407.7** (388)
Serien: 101.5 102.9 101.7 101.6
Zähler: 29 10 1 0 0 0 0 0 0 0
Innenzehner: 25
Weiteste: 528 (2.), 390 (32.), 377 (19.)
beste Teiler: 30.6 (14.), 35.1 (3.), 53.0 (36.)
Trefferlage: 0.17 mm links, 0.14 mm tief
Streuwert: 1.54, horizontal: 1.53, vertikal: 1.56

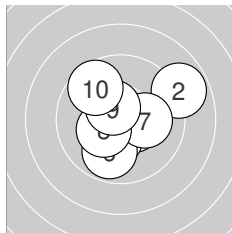
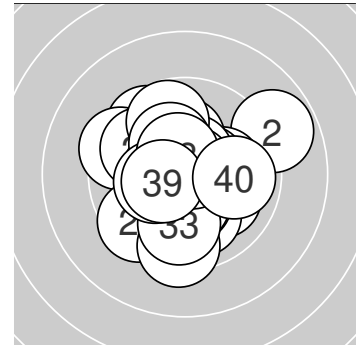

Serie 1: 101.5 (96)

10.6* ↙	8.8 ↗	10.8* ←	10.5* →	10.3* ↓
9.9 ↓	10.2* →	10.3* ↙	10.5* ↘	9.6 ↘

beste Teiler: 35.1 (3.), 91.2 (1.), 113.7 (4.)
Trefferlage: 0.13 mm rechts, 0.04 mm tief
Streuwert: 1.81, horizontal: 1.98, vertikal: 1.61

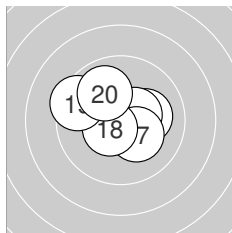

Serie 2: 102.9 (98)

10.7* ↙	10.1 →	10.6* →	10.8* ↙	10.1 ↘
10.5* →	10.3* ↘	10.5* ↙	9.4 ↖	9.9 ↖

beste Teiler: 30.6 (14.), 66.2 (11.), 79.3 (13.)
Trefferlage: 0.26 mm links, 0.27 mm hoch
Streuwert: 1.38, horizontal: 1.64, vertikal: 1.06

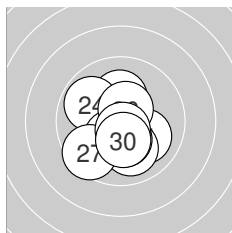

Serie 3: 101.7 (98)

10.0 ↘	10.0 ↓	10.2* ↑	9.9 ↖	10.3* ↙
10.5* ↑	9.5 ↙	10.3* ↓	10.7* ↓	10.3* ↓

beste Teiler: 73.0 (29.), 107.1 (26.), 151.3 (25.)
Trefferlage: 0.18 mm links, 0.67 mm tief
Streuwert: 1.46, horizontal: 1.36, vertikal: 1.55

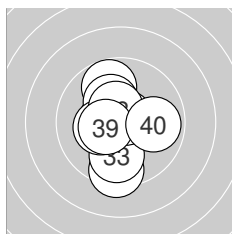

Serie 4: 101.6 (96)

9.8 ↖	9.4 ↓	9.9 ↓	10.5* ←	10.2* ↖
10.7* ↗	10.3* ←	10.5* ↖	10.4* ←	9.9 →

beste Teiler: 53.0 (36.), 114.8 (38.), 116.4 (34.)
Trefferlage: 0.37 mm links, 0.14 mm tief
Streuwert: 1.63, horizontal: 1.21, vertikal: 1.96



Ergebnis: 416.5 (399)
Serien: 103.9 104.1 104.1 104.4
Zähler: 39 1 0 0 0 0 0 0 0 0 0
Innenzehner: 36
Weiteste: 273 (10.), 218 (17.), 214 (39.)
beste Teiler: 24.4 (1.), 54.2 (38.), 54.9 (23.)
Trefferlage: 0.31 mm links, 0.04 mm hoch
Streuwert: 1.00, horizontal: 0.95, vertikal: 1.05

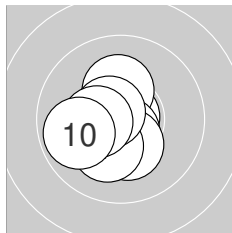
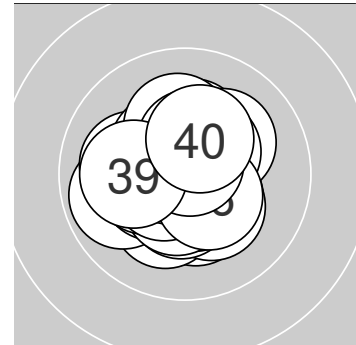

Serie 1: 103.9 (99)

10.9* ↗	10.2* ↓	10.2* ↑	10.6* ↓	10.6* ↓
10.3* ↓	10.2* ↓	10.6* ↖	10.4* ←	9.9 ←

beste Teiler: 24.4 (1.), 83.2 (8.), 85.6 (5.)
Trefferlage: 0.57 mm links, 0.53 mm tief
Streuwert: 1.01, horizontal: 0.92, vertikal: 1.10

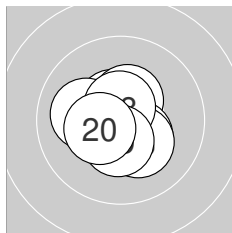

Serie 2: 104.1 (100)

10.5* ↖	10.4* ↑	10.4* ↘	10.6* ↓	10.3* ↘
10.4* ←	10.1 ←	10.6* ↑	10.4* ↓	10.4* ←

beste Teiler: 81.2 (14.), 83.2 (18.), 104.6 (11.)
Trefferlage: 0.32 mm links, 0.15 mm tief
Streuwert: 1.01, horizontal: 1.05, vertikal: 0.96

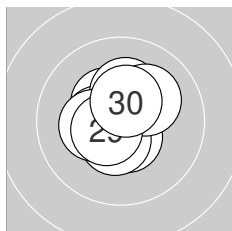

Serie 3: 104.1 (100)

10.5* ↓	10.4* ↖	10.7* ←	10.4* ←	10.5* ↓
10.3* ↑	10.3* ←	10.1 ↗	10.5* ←	10.4* ↑

beste Teiler: 54.9 (23.), 101.8 (29.), 103.8 (21.)
Trefferlage: 0.30 mm links, 0.23 mm hoch
Streuwert: 0.99, horizontal: 0.95, vertikal: 1.03

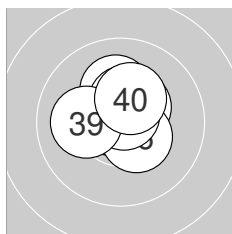

Serie 4: 104.4 (100)

10.7* ←	10.6* ↑	10.6* ←	10.2* ↑	10.4* ↗
10.4* ↘	10.4* ↑	10.7* ↑	10.1 ←	10.3* ↑

beste Teiler: 54.2 (38.), 57.0 (31.), 81.0 (32.)
Trefferlage: 0.07 mm links, 0.64 mm hoch
Streuwert: 0.89, horizontal: 0.95, vertikal: 0.83



Ergebnis: **386.7** (366)
 Serien: 98.0 94.8 99.1 94.8
 Zähler: 19 11 7 3 0 0 0 0 0 0
 Innenzehner: 12
 Weitester: 838 (17.), 791 (14.), 765 (39.)
 beste Teiler: 37.4 (23.), 43.2 (38.), 60.0 (29.)
 Trefferlage: 0.29 mm rechts, 0.21 mm tief
 Streuwert: 2.78, horizontal: 3.48, vertikal: 1.82

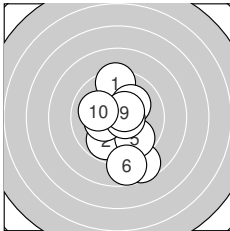
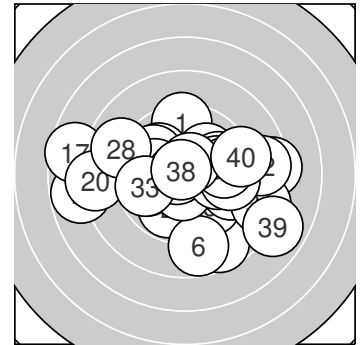

Serie 1: 98.0 (93)

9.4 ↑ 9.8 ↙ 8.7 ↓ 10.1 ↗ 9.7 ↘
 8.8 ↓ 10.3* ← 10.6* → 10.6* ↗ 10.0 ←
 beste Teiler: 84.3 (8.), 100.1 (9.), 159.2 (7.)
 Trefferlage: 0.33 mm rechts, 0.92 mm tief
 Streuwert: 2.34, horizontal: 1.58, vertikal: 2.91

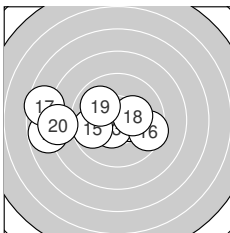

Serie 2: 94.8 (90)

10.4* → 10.7* ↙ 10.5* ↙ 7.8 ← 9.8 ←
 9.5 → 7.6 ← 10.2* → 10.0 ↘ 8.3 ←
 beste Teiler: 60.4 (12.), 109.2 (13.), 138.7 (11.)
 Trefferlage: 2.21 mm links, 0.16 mm tief
 Streuwert: 3.02, horizontal: 4.13, vertikal: 1.08

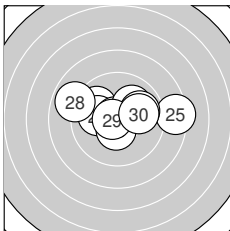

Serie 3: 99.1 (94)

9.9 ↘ 10.0 ← 10.8* ↘ 10.1 ↗ 8.3 →
 10.5* ↓ 9.9 → 8.9 ↘ 10.7* ← 10.0 →
 beste Teiler: 37.4 (23.), 60.0 (29.), 124.1 (26.)
 Trefferlage: 0.25 mm rechts, 0.64 mm hoch
 Streuwert: 2.32, horizontal: 3.16, vertikal: 0.91

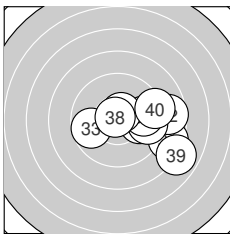

Serie 4: 94.8 (89)

8.5 → 8.7 → 9.7 ← 10.0 → 9.6 →
 9.8 → 10.6* ↑ 10.8* ↘ 7.9 ↘ 9.2 →
 beste Teiler: 43.2 (38.), 93.5 (37.), 247.0 (34.)
 Trefferlage: 2.80 mm rechts, 0.42 mm tief
 Streuwert: 2.41, horizontal: 3.02, vertikal: 1.59



Ergebnis: 411.4 (392)
Serien: 102.6 102.2 102.1 104.5
Zähler: 32 8 0 0 0 0 0 0 0 0
Innenzehner: 26
Weiteste: 369 (26.), 367 (14.), 322 (2.)
beste Teiler: 7.6 (35.), 29.9 (15.), 37.4 (10.)
Trefferlage: 0.01 mm rechts, 0.27 mm hoch
Streuwert: 1.34, horizontal: 1.23, vertikal: 1.44

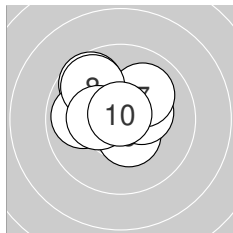
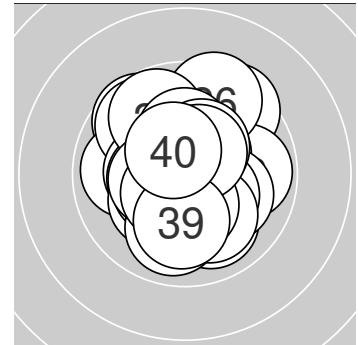

Serie 1: 102.6 (97)

10.7* ←	9.7 ↘	10.6* ↗	9.9 ←	10.5* ↘
10.3* →	10.0 ↗	9.8 ↘	10.3* ←	10.8* ↑

beste Teiler: 37.4 (10.), 51.0 (1.), 95.0 (3.)
Trefferlage: 0.47 mm links, 0.73 mm hoch
Streuwert: 1.32, horizontal: 1.51, vertikal: 1.10

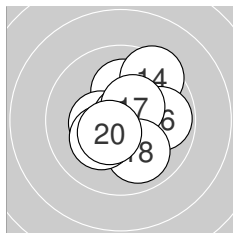

Serie 2: 102.2 (98)

10.1 ↑	10.4* ←	10.5* →	9.5 ↗	10.8* ↗
9.8 →	10.4* ↗	10.0 ↘	10.2* ↗	10.5* ↗

beste Teiler: 29.9 (15.), 116.1 (20.), 124.0 (13.)
Trefferlage: 0.51 mm rechts, 0.17 mm hoch
Streuwert: 1.46, horizontal: 1.41, vertikal: 1.50

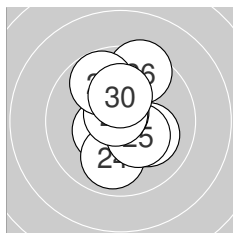

Serie 3: 102.1 (97)

10.4* ←	10.1 ↘	10.5* ↑	9.9 ↓	10.3* ↘
9.5 ↑	10.7* ↘	10.7* ↘	9.8 ↘	10.2* ↑

beste Teiler: 61.0 (28.), 66.7 (27.), 116.2 (23.)
Trefferlage: 0.06 mm rechts, 0.50 mm hoch
Streuwert: 1.50, horizontal: 1.08, vertikal: 1.82

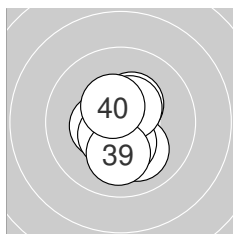

Serie 4: 104.5 (100)

10.7* ↘	10.1 ↘	10.4* ↗	10.4* ←	10.9* ↗
10.4* ↓	10.5* ↗	10.5* ↗	10.1 ↓	10.5* ↘

beste Teiler: 7.6 (35.), 60.8 (31.), 116.2 (37.)
Trefferlage: 0.04 mm links, 0.29 mm tief
Streuwert: 1.04, horizontal: 0.77, vertikal: 1.25



Ergebnis: 413.1 (395)
Serien: 102.5 104.9 103.3 102.4
Zähler: 35 5 0 0 0 0 0 0 0 0 0
Innenzehner: 29
Weiteste: 351 (7.), 349 (38.), 341 (28.)
beste Teiler: 23.4 (9.), 23.7 (26.), 27.5 (29.)
Trefferlage: 0.42 mm rechts, 0.37 mm hoch
Streuwert: 1.24, horizontal: 1.37, vertikal: 1.11

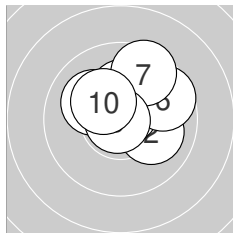
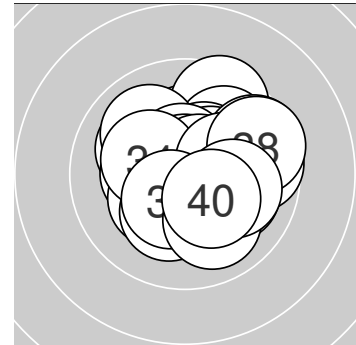

Serie 1: 102.5 (98)

10.2* ↑	10.1 ↘	10.4* ↗	10.7* ↗	10.6* ↑
9.7 ↗	9.5 ↗	10.1 ↘	10.9* ←	10.3* ↘

beste Teiler: 23.4 (9.), 62.4 (4.), 82.2 (5.)
Trefferlage: 0.44 mm rechts, 1.05 mm hoch
Streuwert: 1.27, horizontal: 1.43, vertikal: 1.08

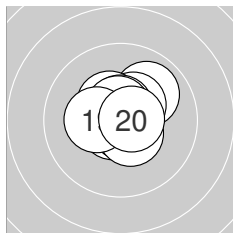

Serie 2: 104.9 (100)

10.7* ↙	10.0 ↗	10.4* ↗	10.4* ↘	10.6* ↑
10.7* ↘	10.6* ↑	10.5* ↘	10.3* ←	10.7* →

beste Teiler: 58.6 (16.), 69.5 (11.), 75.4 (20.)
Trefferlage: 0.11 mm rechts, 0.37 mm hoch
Streuwert: 0.91, horizontal: 0.96, vertikal: 0.86

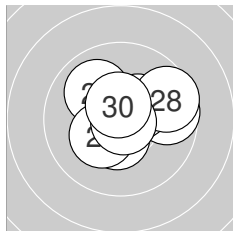

Serie 3: 103.3 (98)

10.5* ↓	10.5* ↘	9.7 →	10.0 ↘	10.4* ↗
10.9* ↘	10.3* ↗	9.6 →	10.8* ↘	10.6* ↑

beste Teiler: 23.7 (26.), 27.5 (29.), 98.3 (30.)
Trefferlage: 0.41 mm rechts, 0.38 mm hoch
Streuwert: 1.36, horizontal: 1.64, vertikal: 1.01

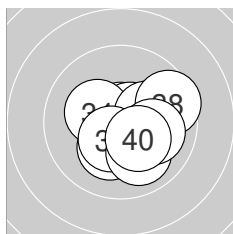

Serie 4: 102.4 (99)

10.8* ↑	10.2* ↓	10.6* ↗	10.3* ↘	10.2* →
10.4* ↙	10.0 ↘	9.6 →	10.0 →	10.3* ↘

beste Teiler: 48.0 (31.), 80.0 (33.), 132.0 (36.)
Trefferlage: 0.73 mm rechts, 0.32 mm tief
Streuwert: 1.34, horizontal: 1.49, vertikal: 1.16



Ergebnis: 414.3 (394)
Serien: 101.9 103.5 104.7 104.2
Zähler: 34 6 0 0 0 0 0 0 0 0 0
Innenzehner: 31
Weiteste: 348 (17.), 318 (10.), 313 (6.)
beste Teiler: 7.2 (18.), 39.5 (24.), 48.0 (26.)
Trefferlage: 0.05 mm links, 0.06 mm tief
Streuwert: 1.22, horizontal: 1.32, vertikal: 1.11

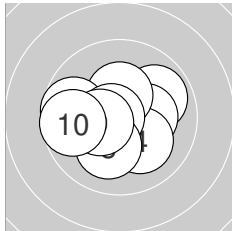
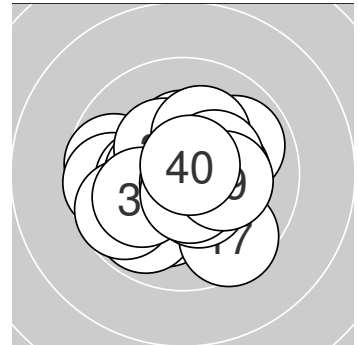

Serie 1: 101.9 (97)

9.9 ↗	10.3* →	10.6* ↓	10.1 ↘	10.4* ↑
9.7 ←	10.7* ←	10.1 ↓	10.4* ←	9.7 ←

beste Teiler: 56.0 (7.), 85.0 (3.), 134.6 (9.)
Trefferlage: 0.34 mm links, 0.17 mm tief
Streuwert: 1.53, horizontal: 1.86, vertikal: 1.10

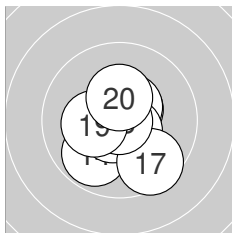

Serie 2: 103.5 (98)

10.6* ↗	10.3* ↗	10.5* ↗	9.8 ↗	10.6* ↘
10.6* ↗	9.6 ↘	10.9* ↓	10.3* ←	10.3* ↑

beste Teiler: 7.2 (18.), 78.0 (16.), 95.5 (15.)
Trefferlage: 0.10 mm links, 0.47 mm tief
Streuwert: 1.28, horizontal: 1.19, vertikal: 1.36

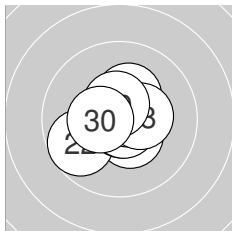

Serie 3: 104.7 (99)

10.4* ↘	9.7 ↗	10.7* ↑	10.8* ↘	10.3* ↑
10.8* ↘	10.7* ↗	10.4* →	10.5* ↑	10.4* ←

beste Teiler: 39.5 (24.), 48.0 (26.), 60.0 (23.)
Trefferlage: 0.04 mm links, 0.02 mm hoch
Streuwert: 1.05, horizontal: 1.15, vertikal: 0.93

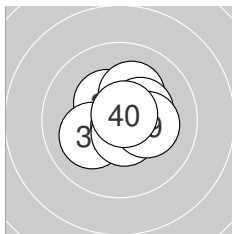

Serie 4: 104.2 (100)

10.6* ↑	10.3* ↑	10.4* ↘	10.1 ↗	10.2* ↑
10.3* ↗	10.8* ↘	10.6* ↓	10.2* →	10.7* ↗

beste Teiler: 49.2 (37.), 51.2 (40.), 91.7 (38.)
Trefferlage: 0.28 mm rechts, 0.36 mm hoch
Streuwert: 1.01, horizontal: 1.05, vertikal: 0.97



Ergebnis: **417.0** (396)
 Serien: 104.9 104.4 103.0 104.7
 Zähler: 36 4 0 0 0 0 0 0 0 0
 Innenzehner: 30
 Weitestе: 287 (5.), 285 (40.), 279 (30.)
 beste Teiler: 21.5 (32.), 28.2 (14.), 40.0 (11.)
 Trefferlage: 0.32 mm links, 0.17 mm hoch
 Streuwert: 1.08, horizontal: 1.33, vertikal: 0.75

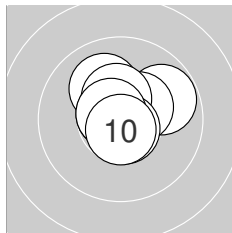
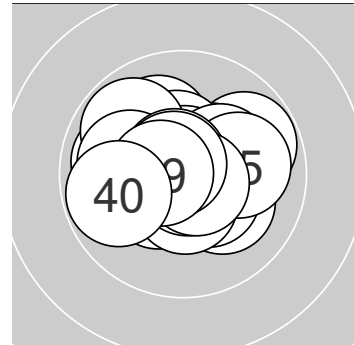

Serie 1: 104.9 (99)

10.6* ↑	10.1 ↘	10.8* ↖	10.7* ↖	9.8 ↗
10.4* ↗	10.4* ↑	10.7* ↓	10.7* ↖	10.7* ↓

beste Teiler: 43.8 (3.), 65.3 (8.), 66.0 (10.)
 Trefferlage: 0.11 mm rechts, 0.58 mm hoch
 Streuwert: 0.95, horizontal: 1.05, vertikal: 0.83

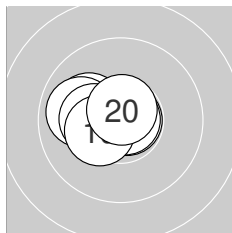

Serie 2: 104.4 (99)

10.8* →	10.5* ←	10.4* ←	10.8* →	10.5* ←
10.1 ↖	9.9 ↖	10.3* ←	10.4* ↖	10.7* ↑

beste Teiler: 28.2 (14.), 40.0 (11.), 66.4 (20.)
 Trefferlage: 1.05 mm links, 0.11 mm hoch
 Streuwert: 0.76, horizontal: 0.99, vertikal: 0.43

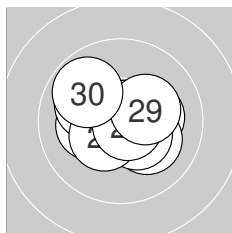

Serie 3: 103.0 (99)

10.8* ↗	10.2* ←	10.2* →	10.1 ↘	10.4* ↘
10.1 ↖	10.4* ↗	10.7* ↘	10.3* ↗	9.8 ↘

beste Teiler: 45.6 (21.), 51.9 (28.), 135.7 (25.)
 Trefferlage: 0.01 mm links, 0.07 mm hoch
 Streuwert: 1.32, horizontal: 1.60, vertikal: 0.96

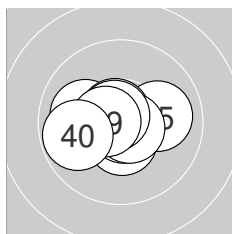

Serie 4: 104.7 (99)

10.5* ↓	10.9* →	10.8* ↘	10.0 ←	10.0 →
10.7* ↘	10.7* ↘	10.7* ↘	10.6* ←	9.8 ←

beste Teiler: 21.5 (32.), 42.0 (33.), 57.3 (38.)
 Trefferlage: 0.32 mm links, 0.09 mm tief
 Streuwert: 1.09, horizontal: 1.43, vertikal: 0.58



Ergebnis: 412.7 (393)
Serien: 104.6 103.8 101.8 102.5
Zähler: 33 7 0 0 0 0 0 0 0 0
Innenzehner: 29
Weiteste: 405 (28.), 316 (32.), 311 (29.)
beste Teiler: 37.5 (1.), 43.9 (6.), 45.1 (21.)
Trefferlage: 0.50 mm rechts, 0.22 mm tief
Streuwert: 1.25, horizontal: 1.38, vertikal: 1.10

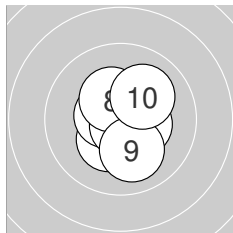
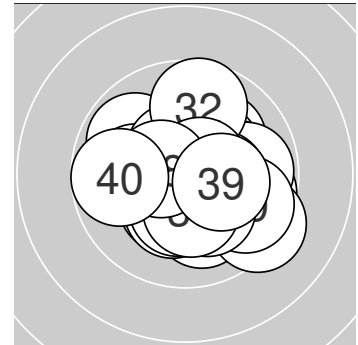

Serie 1: 104.6 (100)

10.8* ↗	10.6* →	10.6* →	10.3* ↘	10.5* ←
10.8* ↓	10.4* →	10.4* ↖	10.1 ↓	10.1 ↗

beste Teiler: 37.5 (1.), 43.9 (6.), 78.6 (2.)
Trefferlage: 0.33 mm rechts, 0.07 mm tief
Streuwert: 1.00, horizontal: 0.89, vertikal: 1.10

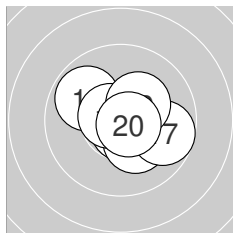

Serie 2: 103.8 (98)

10.7* ↘	10.7* ↓	10.6* →	10.3* ↘	10.3* ↘
9.9 ↖	9.7 →	10.6* ←	10.3* ↗	10.7* ↘

beste Teiler: 62.0 (12.), 62.1 (20.), 70.0 (11.)
Trefferlage: 0.54 mm rechts, 0.23 mm tief
Streuwert: 1.18, horizontal: 1.36, vertikal: 0.96

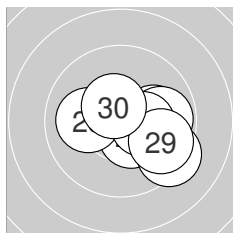

Serie 3: 101.8 (97)

10.8* ↘	10.8* ↑	10.5* ↘	10.0 →	10.1 ←
9.8 →	10.3* →	9.3 ↘	9.7 ↘	10.5* ↖

beste Teiler: 45.1 (21.), 45.3 (22.), 114.1 (30.)
Trefferlage: 1.12 mm rechts, 0.31 mm tief
Streuwert: 1.42, horizontal: 1.75, vertikal: 0.98

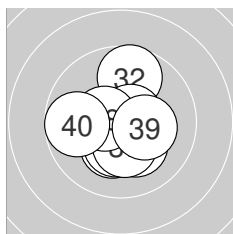

Serie 4: 102.5 (98)

10.2* ↘	9.7 ↑	10.6* →	10.6* ↗	10.3* ↘
10.3* ↓	10.3* ↓	10.5* ←	10.3* →	9.7 ←

beste Teiler: 79.1 (34.), 81.5 (33.), 112.5 (38.)
Trefferlage: 0.00 mm , 0.28 mm tief
Streuwert: 1.40, horizontal: 1.34, vertikal: 1.46



Ergebnis: **412.2** (391)
 Serien: 99.3 105.9 103.2 103.8
 Zähler: 32 7 1 0 0 0 0 0 0 0
 Innenzehner: 28
 Weitestе: 539 (7.), 464 (4.), 347 (2.)
 beste Teiler: 8.2 (13.), 18.9 (33.), 23.4 (14.)
 Trefferlage: 0.48 mm links, 0.53 mm hoch
 Streuwert: 1.34, horizontal: 1.66, vertikal: 0.91

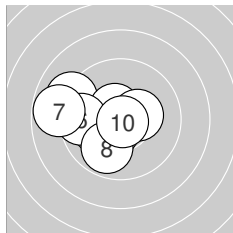
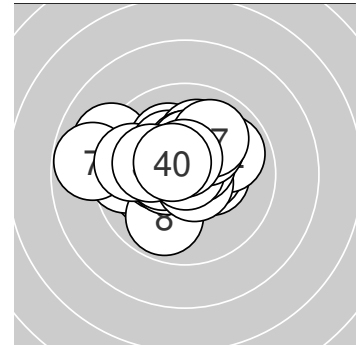

Serie 1: 99.3 (94)

10.5* ↙	9.6 ←	10.1 ←	9.1 ↖	10.6* ↘
9.6 ←	8.8 ←	9.9 ↙	10.3* →	10.8* ↘

beste Teiler: 27.8 (10.), 99.4 (5.), 123.8 (1.)
 Trefferlage: 1.91 mm links, 0.03 mm tief
 Streuwert: 1.74, horizontal: 2.16, vertikal: 1.18

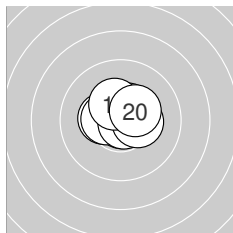

Serie 2: 105.9 (100)

10.4* ←	10.8* ↖	10.9* →	10.9* ↓	10.5* ←
10.5* ↗	10.8* ↘	10.4* →	10.4* ↖	10.3* ↗

beste Teiler: 8.2 (13.), 23.4 (14.), 37.5 (17.)
 Trefferlage: 0.02 mm rechts, 0.30 mm hoch
 Streuwert: 0.79, horizontal: 0.96, vertikal: 0.56

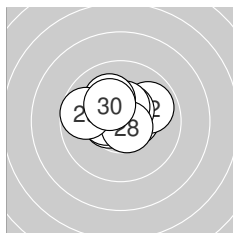

Serie 3: 103.2 (98)

10.5* →	9.9 ↗	10.6* ←	10.5* ←	10.5* ↗
10.4* ↑	10.1 ↖	10.7* ↘	9.7 ←	10.3* ↖

beste Teiler: 73.6 (28.), 100.4 (23.), 112.7 (21.)
 Trefferlage: 0.21 mm links, 0.70 mm hoch
 Streuwert: 1.20, horizontal: 1.52, vertikal: 0.76

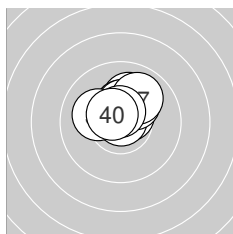

Serie 4: 103.8 (99)

10.1 ↑	10.6* ↗	10.9* ↑	10.2* ↗	10.4* ↑
10.4* ↑	9.9 ↗	10.1 ←	10.6* ↑	10.6* ↖

beste Teiler: 18.9 (33.), 90.0 (32.), 91.3 (39.)
 Trefferlage: 0.14 mm rechts, 1.15 mm hoch
 Streuwert: 0.83, horizontal: 0.98, vertikal: 0.65



Ergebnis: 410.2 (390)
Serien: 101.9 102.5 102.4 103.4
Zähler: 30 10 0 0 0 0 0 0 0 0
Innenzehner: 26
Weiteste: 366 (9.), 349 (27.), 303 (3.)
beste Teiler: 27.7 (19.), 44.6 (24.), 48.0 (8.)
Trefferlage: 0.32 mm rechts, 0.02 mm hoch
Streuwert: 1.39, horizontal: 1.46, vertikal: 1.32

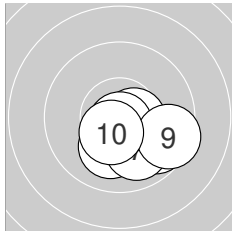
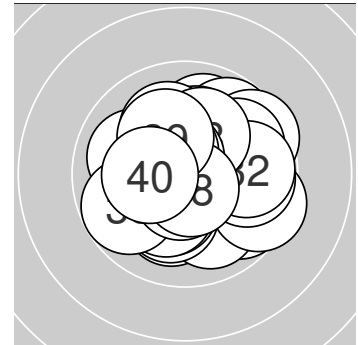

Serie 1: 101.9 (97)

9.9 ↘	10.5* ↓	9.7 ↘	10.5* →	10.4* ↓
10.1 ↓	10.0 ↘	10.8* ↓	9.5 →	10.5* ↓

beste Teiler: 48.0 (8.), 101.0 (4.), 102.1 (2.)
Trefferlage: 0.85 mm rechts, 1.29 mm tief
Streuwert: 1.10, horizontal: 1.43, vertikal: 0.62

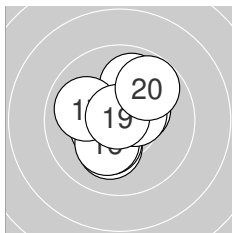

Serie 2: 102.5 (98)

10.2* ↓	10.3* ↓	10.4* ←	10.4* →	9.9 ↑
10.2* ↓	10.0 ↖	10.5* →	10.8* ↘	9.8 ↗

beste Teiler: 27.7 (19.), 113.0 (18.), 132.6 (13.)
Trefferlage: 0.07 mm links, 0.12 mm hoch
Streuwert: 1.43, horizontal: 1.32, vertikal: 1.52

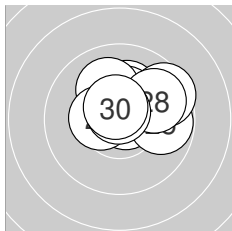

Serie 3: 102.4 (97)

10.2* ↑	10.3* ↑	10.1 ↖	10.8* →	9.8 →
10.4* ←	9.6 ↗	9.9 ↗	10.7* ↑	10.6* ↑

beste Teiler: 44.6 (24.), 51.7 (29.), 88.5 (30.)
Trefferlage: 0.71 mm rechts, 0.96 mm hoch
Streuwert: 1.23, horizontal: 1.54, vertikal: 0.81

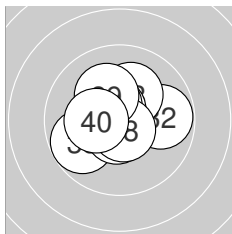

Serie 4: 103.4 (98)

10.7* ↗	9.8 →	10.2* ↑	10.6* ↖	9.8 ←
10.6* ↓	10.5* ↖	10.7* ↓	10.2* ↖	10.3* ←

beste Teiler: 53.0 (31.), 70.9 (38.), 83.7 (34.)
Trefferlage: 0.20 mm links, 0.27 mm hoch
Streuwert: 1.29, horizontal: 1.47, vertikal: 1.07



Ergebnis: 417.6 (394)
Serien: 103.1 106.5 103.6 104.4
Zähler: 34 6 0 0 0 0 0 0 0 0 0
Innenzehner: 31
Weiteste: 309 (38.), 284 (6.), 283 (21.)
beste Teiler: 7.6 (37.), 21.1 (32.), 26.0 (13.)
Trefferlage: 0.27 mm rechts, 0.16 mm tief
Streuwert: 1.09, horizontal: 1.06, vertikal: 1.11

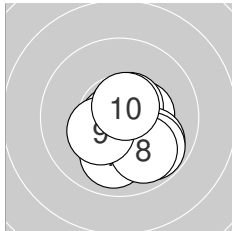
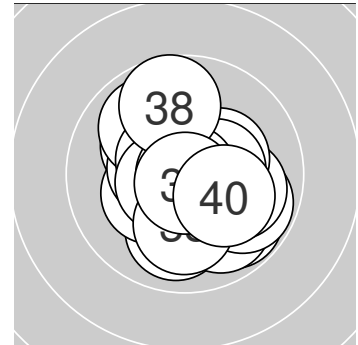

Serie 1: 103.1 (97)

10.8* ↗	10.4* →	10.6* ↗	9.9 ↘	10.8* ↖
9.8 ↘	10.0 ↓	9.9 ↘	10.3* ↖	10.6* ↗

beste Teiler: 44.2 (1.), 47.8 (5.), 81.8 (10.)
Trefferlage: 0.63 mm rechts, 0.72 mm tief
Streuwert: 1.19, horizontal: 1.14, vertikal: 1.23

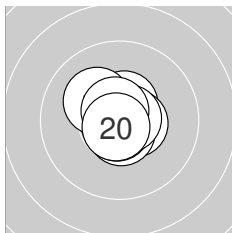

Serie 2: 106.5 (100)

10.5* ↗	10.6* →	10.8* →	10.6* ↓	10.8* ←
10.8* ↘	10.7* →	10.2* ↘	10.7* ↘	10.8* ↘

beste Teiler: 26.0 (13.), 37.2 (15.), 49.0 (16.)
Trefferlage: 0.04 mm links, 0.10 mm hoch
Streuwert: 0.66, horizontal: 0.66, vertikal: 0.66

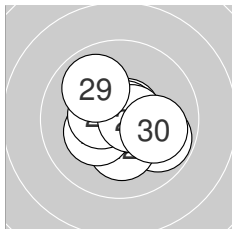

Serie 3: 103.6 (98)

9.8 ↘	10.2* ↓	10.8* →	10.7* ↗	10.8* ↗
10.3* ↖	10.5* ←	10.6* →	9.9 ↘	10.0 →

beste Teiler: 43.1 (23.), 44.5 (25.), 62.9 (24.)
Trefferlage: 0.26 mm rechts, 0.14 mm tief
Streuwert: 1.26, horizontal: 1.42, vertikal: 1.07

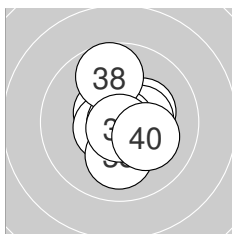

Serie 4: 104.4 (99)

10.5* ↘	10.9* ↗	10.3* →	10.6* ↖	10.1 ↓
10.4* →	10.9* ↘	9.7 ↑	10.8* ↓	10.2* ↘

beste Teiler: 7.6 (37.), 21.1 (32.), 40.0 (39.)
Trefferlage: 0.23 mm rechts, 0.07 mm hoch
Streuwert: 1.16, horizontal: 0.96, vertikal: 1.33



Ergebnis: 417.6 (397)
Serien: 104.0 104.3 104.5 104.8
Zähler: 37 3 0 0 0 0 0 0 0 0 0
Innenzehner: 37
Weiteste: 327 (1.), 259 (17.), 252 (35.)
beste Teiler: 5.0 (27.), 17.1 (34.), 17.4 (19.)
Trefferlage: 0.06 mm rechts, 0.15 mm tief
Streuwert: 1.03, horizontal: 1.11, vertikal: 0.95

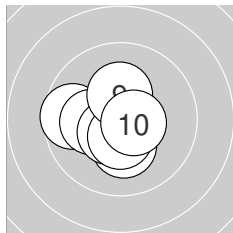
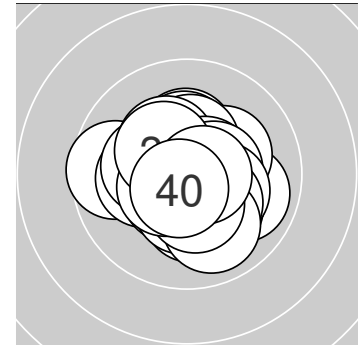

Serie 1: 104.0 (99)

9.6 ←	10.2* ←	10.6* ↓	10.8* ↗	10.2* ↓
10.7* ↘	10.5* ↗	10.5* ↓	10.3* ↑	10.6* →

beste Teiler: 46.7 (4.), 63.4 (6.), 76.4 (3.)
Trefferlage: 0.40 mm links, 0.33 mm tief
Streuwert: 1.12, horizontal: 1.27, vertikal: 0.95

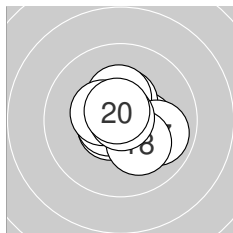

Serie 2: 104.3 (99)

10.3* →	10.4* ↑	10.3* ↑	10.6* ↖	10.6* ←
10.4* ↖	9.9 →	10.2* ↘	10.9* ↑	10.7* ↖

beste Teiler: 17.4 (19.), 67.7 (20.), 81.4 (15.)
Trefferlage: 0.24 mm rechts, 0.07 mm hoch
Streuwert: 1.05, horizontal: 1.15, vertikal: 0.94

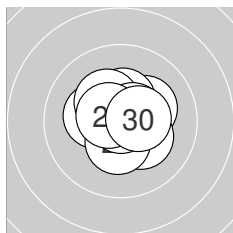

Serie 3: 104.5 (100)

10.2* ↗	10.3* ↘	10.3* ←	10.4* ↓	10.4* ↑
10.3* ↖	10.9* ↗	10.6* →	10.6* ↖	10.5* →

beste Teiler: 5.0 (27.), 89.8 (29.), 90.8 (28.)
Trefferlage: 0.16 mm rechts, 0.25 mm hoch
Streuwert: 1.01, horizontal: 1.10, vertikal: 0.90

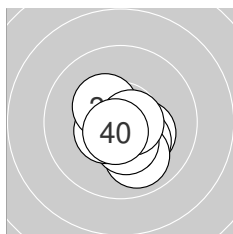

Serie 4: 104.8 (99)

10.3* ↘	10.2* ↘	10.8* ←	10.9* →	9.9 ↘
10.4* ↓	10.5* ↗	10.4* ↖	10.7* →	10.7* ↗

beste Teiler: 17.1 (34.), 30.4 (33.), 72.1 (39.)
Trefferlage: 0.24 mm rechts, 0.59 mm tief
Streuwert: 0.92, horizontal: 0.91, vertikal: 0.92



Ergebnis: **417.8** (397)
 Serien: 104.2 104.6 104.5 104.5
 Zähler: 37 3 0 0 0 0 0 0 0 0
 Innenzehner: 33
 Weitestе: 295 (39.), 261 (3.), 252 (29.)
 beste Teiler: 30.4 (37.), 42.2 (36.), 46.0 (32.)
 Trefferlage: 0.38 mm links, 0.21 mm tief
 Streuwert: 0.98, horizontal: 1.05, vertikal: 0.91

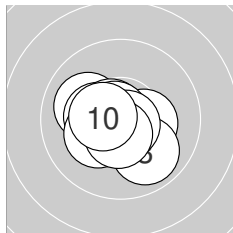
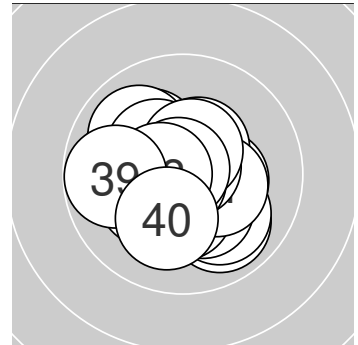

Serie 1: 104.2 (99)

10.0 ↖	10.3* →	9.9 ↘	10.4* ←	10.6* ↗
10.3* ↙	10.8* ↘	10.8* ↘	10.6* ↓	10.5* ←

beste Teiler: 46.3 (7.), 48.7 (8.), 76.3 (5.)
 Trefferlage: 0.40 mm links, 0.27 mm tief
 Streuwert: 1.08, horizontal: 1.26, vertikal: 0.85

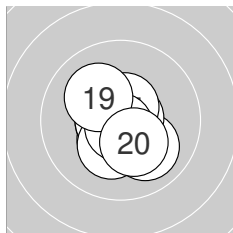

Serie 2: 104.6 (100)

10.4* ↓	10.7* ←	10.0 ↘	10.7* ←	10.3* ↓
10.7* →	10.6* ↑	10.8* ↓	10.1 ↖	10.3* ↘

beste Teiler: 46.3 (18.), 60.6 (16.), 74.3 (14.)
 Trefferlage: 0.09 mm links, 0.41 mm tief
 Streuwert: 1.01, horizontal: 0.92, vertikal: 1.09

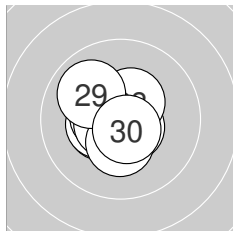

Serie 3: 104.5 (99)

10.4* ←	10.4* ←	10.6* ↘	10.8* ←	10.5* ←
10.6* ←	10.3* ↓	10.4* ↑	9.9 ↖	10.6* ↘

beste Teiler: 47.1 (24.), 78.0 (30.), 82.4 (23.)
 Trefferlage: 0.52 mm links, 0.08 mm tief
 Streuwert: 0.91, horizontal: 0.91, vertikal: 0.90

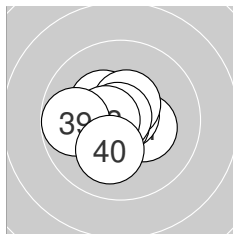

Serie 4: 104.5 (99)

10.3* →	10.8* ↗	10.3* ↘	10.5* ←	10.5* ↑
10.8* ↙	10.8* ↘	10.6* ←	9.8 ←	10.1 ↓

beste Teiler: 30.4 (37.), 42.2 (36.), 46.0 (32.)
 Trefferlage: 0.52 mm links, 0.06 mm tief
 Streuwert: 1.03, horizontal: 1.17, vertikal: 0.86



Ergebnis: 417.7 (400)
Serien: 104.2 104.5 105.4 103.6
Zähler: 40 0 0 0 0 0 0 0 0 0 0
Innenzehner: 33
Weiteste: 235 (26.), 232 (5.), 232 (23.)
beste Teiler: 16.7 (30.), 21.9 (25.), 35.8 (8.)
Trefferlage: 0.62 mm links, 0.07 mm hoch
Streuwert: 0.92, horizontal: 0.84, vertikal: 1.00

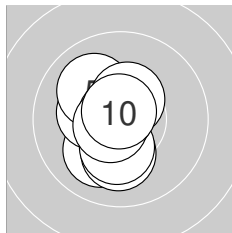
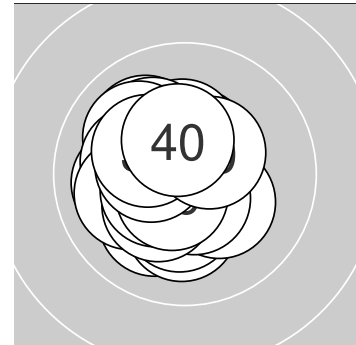

Serie 1: 104.2 (100)

10.1 ↙	10.1 ↓	10.3* ←	10.6* ↑	10.0 ↘
10.3* ↓	10.5* ↑	10.8* ↘	10.7* ↙	10.8* ↑

beste Teiler: 35.8 (8.), 48.0 (10.), 70.3 (9.)
Trefferlage: 0.54 mm links, 0.10 mm tief
Streuwert: 1.06, horizontal: 0.69, vertikal: 1.33

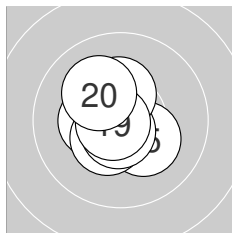

Serie 2: 104.5 (100)

10.6* ↙	10.4* ↘	10.7* ↙	10.3* ←	10.2* ↘
10.4* ↙	10.7* ↓	10.3* ↑	10.8* ←	10.1 ↘

beste Teiler: 48.7 (19.), 63.6 (13.), 67.6 (17.)
Trefferlage: 0.49 mm links, 0.03 mm hoch
Streuwert: 0.93, horizontal: 0.79, vertikal: 1.05

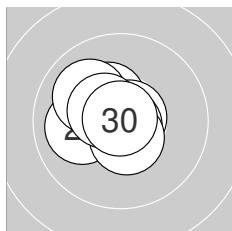

Serie 3: 105.4 (100)

10.4* ↘	10.7* ↙	10.0 ←	10.7* ↗	10.9* ↘
10.0 ↘	10.8* ↘	10.5* ↓	10.5* ↘	10.9* ↑

beste Teiler: 16.7 (30.), 21.9 (25.), 36.1 (27.)
Trefferlage: 0.55 mm links, 0.21 mm hoch
Streuwert: 0.85, horizontal: 0.94, vertikal: 0.75

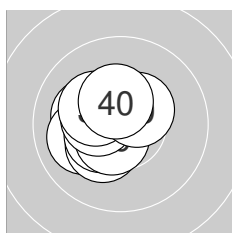

Serie 4: 103.6 (100)

10.2* ←	10.0 ←	10.6* ↑	10.3* ↙	10.4* ↙
10.6* ↙	10.4* ←	10.3* ↘	10.4* ↗	10.4* ↑

beste Teiler: 90.5 (33.), 95.4 (36.), 130.3 (39.)
Trefferlage: 0.89 mm links, 0.13 mm hoch
Streuwert: 0.94, horizontal: 0.97, vertikal: 0.92



Ergebnis: 410.2 (391)
Serien: 103.7 103.0 101.1 102.4
Zähler: 31 9 0 0 0 0 0 0 0 0
Innenzehner: 26
Weiteste: 466 (28.), 393 (30.), 332 (27.)
beste Teiler: 26.4 (14.), 65.9 (21.), 75.3 (23.)
Trefferlage: 0.34 mm links, 0.27 mm hoch
Streuwert: 1.39, horizontal: 1.55, vertikal: 1.22

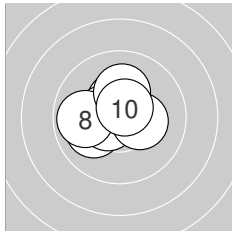
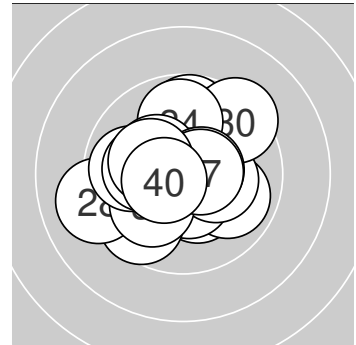

Serie 1: 103.7 (99)

10.1 ←	10.4* ↑	10.5* ←	10.6* ←	10.5* ←
10.6* ←	10.3* →	9.9 ←	10.2* ↑	10.6* ↑

beste Teiler: 79.0 (4.), 86.7 (10.), 100.3 (6.)
Trefferlage: 0.68 mm links, 0.25 mm hoch
Streuwert: 1.06, horizontal: 1.23, vertikal: 0.87

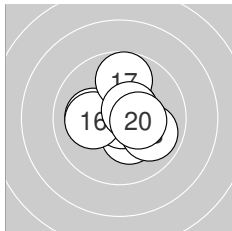

Serie 2: 103.0 (98)

10.3* ↓	10.6* ←	10.1 ←	10.8* ↓	10.5* ↗
10.1 ←	9.8 ↑	9.9 ↘	10.5* ↗	10.4* →

beste Teiler: 26.4 (14.), 89.0 (12.), 102.6 (19.)
Trefferlage: 0.16 mm rechts, 0.17 mm hoch
Streuwert: 1.33, horizontal: 1.44, vertikal: 1.20

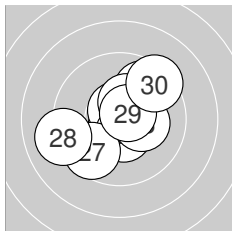

Serie 3: 101.1 (96)

10.7* ↓	9.8 ↗	10.7* ↑	10.5* ↓	10.4* ↑
10.3* →	9.6 ↙	9.1 ←	10.6* ↗	9.4 ↗

beste Teiler: 65.9 (21.), 75.3 (23.), 81.6 (29.)
Trefferlage: 0.06 mm rechts, 0.17 mm hoch
Streuwert: 1.90, horizontal: 2.09, vertikal: 1.69

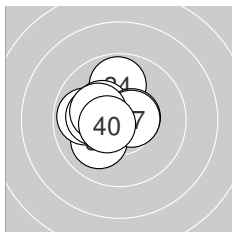

Serie 4: 102.4 (98)

10.0 ↙	9.9 ←	10.3* ↑	9.9 ↑	10.3* ↖
10.6* →	10.6* →	10.1 ←	10.2* ←	10.5* ←

beste Teiler: 93.6 (37.), 99.6 (36.), 104.3 (40.)
Trefferlage: 0.91 mm links, 0.47 mm hoch
Streuwert: 1.18, horizontal: 1.22, vertikal: 1.13



Ergebnis: 383.5 (364)
Serien: 90.4 95.3 98.4 99.4
Zähler: 13 19 7 1 0 0 0 0 0 0 0
Innenzehner: 10
Weiteste: 796 (9.), 651 (2.), 644 (10.)
beste Teiler: 60.7 (28.), 85.1 (29.), 87.3 (38.)
Trefferlage: 1.17 mm links, 0.39 mm tief
Streuwert: 2.61, horizontal: 3.30, vertikal: 1.63

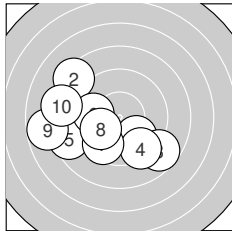
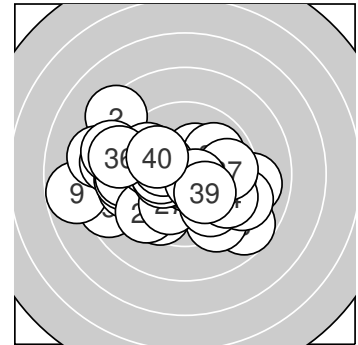

Serie 1: 90.4 (85)

9.9 ↘	8.3 ↘	8.7 ↘	9.3 ↘	8.6 ↙
9.8 ←	9.6 ↙	10.0 ↙	7.8 ←	8.4 ←

beste Teiler: 241.1 (8.), 274.9 (1.), 287.5 (6.)
Trefferlage: 2.29 mm links, 1.10 mm tief
Streuwert: 3.33, horizontal: 4.04, vertikal: 2.43

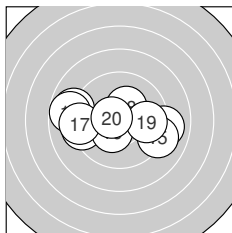

Serie 2: 95.3 (91)

9.0 →	8.9 ←	9.3 ←	8.8 ←	9.1 →
10.3* ↙	9.2 ←	10.3* ↗	9.8 →	10.6* ←

beste Teiler: 90.7 (20.), 151.1 (16.), 162.3 (18.)
Trefferlage: 0.78 mm links, 0.15 mm tief
Streuwert: 2.84, horizontal: 3.86, vertikal: 1.10

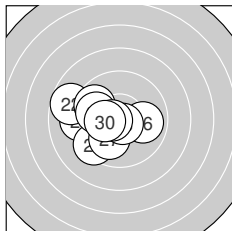

Serie 3: 98.4 (93)

9.2 ←	8.7 ←	9.4 ↙	9.7 ↘	9.9 ←
9.9 →	10.0 ↙	10.7* ↘	10.6* ←	10.3* ←

beste Teiler: 60.7 (28.), 85.1 (29.), 161.3 (30.)
Trefferlage: 1.83 mm links, 0.23 mm tief
Streuwert: 1.87, horizontal: 2.25, vertikal: 1.39

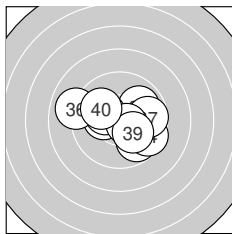

Serie 4: 99.4 (95)

9.9 ↗	10.3* ←	9.8 ↘	9.6 →	10.3* ←
9.0 ←	9.7 →	10.6* ↘	10.2* ↘	10.0 ↘

beste Teiler: 87.3 (38.), 169.0 (35.), 173.3 (32.)
Trefferlage: 0.22 mm rechts, 0.06 mm tief
Streuwert: 2.06, horizontal: 2.60, vertikal: 1.32

