

Ergebnis: **205.0** (196)
 Serien: 102.8 102.2
 Zähler: 16 4 0 0 0 0 0 0 0 0 0
 Innenzehner: 13
 Weitest: 294 (18.), 287 (17.), 283 (19.)
 beste Teiler: 58.0 (6.), 76.1 (12.), 81.2 (4.)
 Trefferlage: 0.05 mm rechts, 0.15 mm tief
 Streuwert: 1.35, horizontal: 1.56, vertikal: 1.09

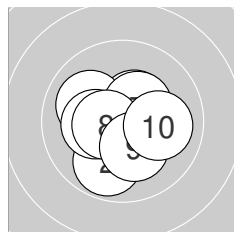
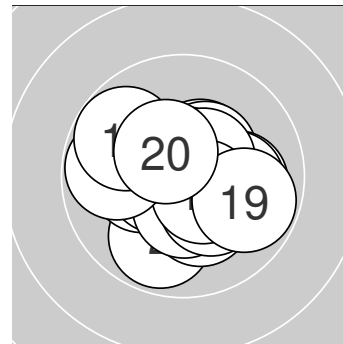

Serie 1: 102.8 (99)

10.4* ↗	9.8 ↓	10.0 ↘	10.6* ↓	10.2* ←
10.7* ↓	10.4* ↗	10.5* ←	10.2* ↓	10.0 →

beste Teiler: 58.0 (6.), 81.2 (4.), 106.5 (8.)
 Trefferlage: 0.06 mm links, 0.30 mm tief
 Streuwert: 1.28, horizontal: 1.37, vertikal: 1.18

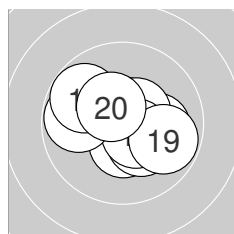

Serie 2: 102.2 (97)

10.1 →	10.6* ↑	10.5* ↗	10.4* ↓	10.3* ↘
10.5* ↘	9.8 ←	9.8 ↘	9.8 →	10.4* ↗

beste Teiler: 76.1 (12.), 109.8 (16.), 111.8 (13.)
 Trefferlage: 0.18 mm rechts, 0.00 mm
 Streuwert: 1.47, horizontal: 1.79, vertikal: 1.04



Ergebnis: **198.9** (191)
 Serien: 99.1 99.8
 Zähler: 13 5 2 0 0 0 0 0 0 0
 Innenzehner: 9
 Weitesten: 739 (10.), 715 (7.), 474 (14.)
 beste Teiler: 21.0 (6.), 52.4 (5.), 57.2 (3.)
 Trefferlage: 1.51 mm rechts, 0.72 mm hoch
 Streuwert: 1.95, horizontal: 2.49, vertikal: 1.19

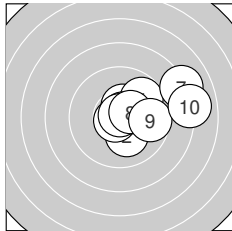
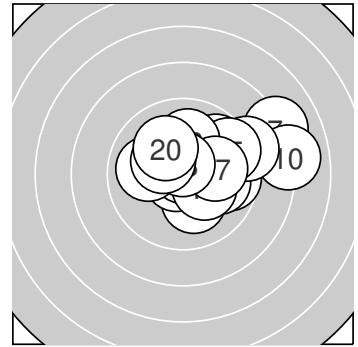

Serie 1: 99.1 (94)

10.5* ↑	10.2* ↓	10.7* ↙	9.8 ↗	10.7* ↗
10.9* ↑	8.1 ↗	10.5* ↗	9.7 →	8.0 →

beste Teiler: 21.0 (6.), 52.4 (5.), 57.2 (3.)
 Trefferlage: 2.13 mm rechts, 0.60 mm hoch
 Streuwert: 2.16, horizontal: 2.73, vertikal: 1.37

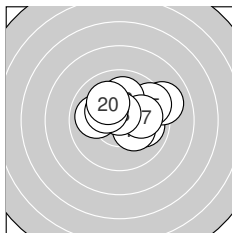

Serie 2: 99.8 (97)

9.9 →	10.0 ←	10.2* ↘	9.1 ↗	9.5 ↗
10.0 ↑	10.0 →	10.7* ↑	10.3* ↖	10.1 ↖

beste Teiler: 69.0 (18.), 165.3 (19.), 176.1 (13.)
 Trefferlage: 0.90 mm rechts, 0.83 mm hoch
 Streuwert: 1.73, horizontal: 2.20, vertikal: 1.06



Ergebnis: **205.0** (196)
 Serien: 102.7 102.3
 Zähler: 16 4 0 0 0 0 0 0 0 0
 Innenzehner: 14
 Weitesten: 497 (19.), 411 (6.), 321 (14.)
 beste Teiler: 51.8 (2.), 73.9 (10.), 82.3 (17.)
 Trefferlage: 0.36 mm rechts, 0.89 mm tief
 Streuwert: 1.36, horizontal: 1.73, vertikal: 0.83

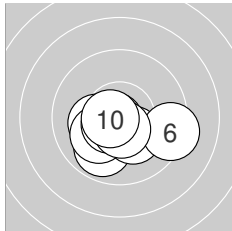
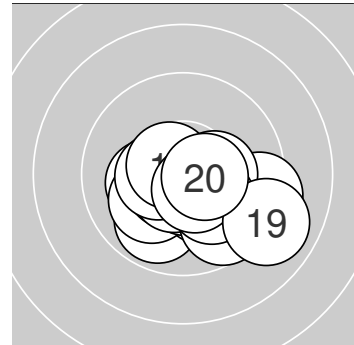

Serie 1: 102.7 (98)

10.3* ↙ 10.7* ↙ 9.9 ↙ 10.2* ← 10.3* ↘
 9.3 → 10.1 ↙ 10.6* ↙ 10.6* ↓ 10.7* ←
 beste Teiler: 51.8 (2.), 73.9 (10.), 92.8 (8.)
 Trefferlage: 0.24 mm links, 0.96 mm tief
 Streuwert: 1.29, horizontal: 1.70, vertikal: 0.65

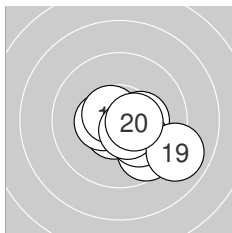

Serie 2: 102.3 (98)

10.5* → 10.6* ↙ 10.3* → 9.7 ↘ 10.1 ↘
 10.4* ← 10.6* ↘ 10.6* ↘ 9.0 → 10.5* →
 beste Teiler: 82.3 (17.), 89.6 (12.), 100.4 (18.)
 Trefferlage: 0.98 mm rechts, 0.81 mm tief
 Streuwert: 1.34, horizontal: 1.60, vertikal: 1.01



Ergebnis: **204.5** (196)
 Serien: 102.0 102.5
 Zähler: 16 4 0 0 0 0 0 0 0 0 0
 Innenzehner: 14
 Weitest: 363 (16.), 361 (6.), 345 (10.)
 beste Teiler: 56.6 (15.), 74.3 (8.), 87.6 (12.)
 Trefferlage: 0.54 mm links, 0.79 mm hoch
 Streuwert: 1.32, horizontal: 1.61, vertikal: 0.94

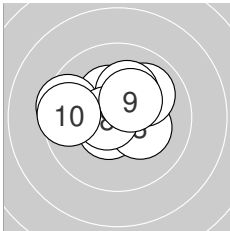
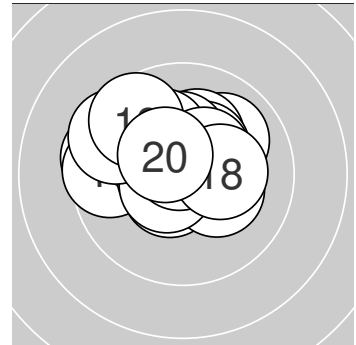

Serie 1: 102.0 (98)

10.6* ↙	10.5* ↘	10.3* →	10.0 ↗	10.3* ↘
9.5 ←	10.2* ↑	10.7* ←	10.3* ↗	9.6 ←

beste Teiler: 74.3 (8.), 96.5 (1.), 102.4 (2.)
 Trefferlage: 0.44 mm links, 0.63 mm hoch
 Streuwert: 1.47, horizontal: 1.86, vertikal: 0.92

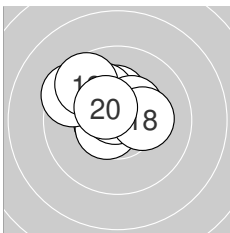

Serie 2: 102.5 (98)

10.3* ↑	10.6* ←	10.1 ↘	10.6* ↙	10.7* ↘
9.5 ↘	10.4* ↗	10.2* →	9.6 ↘	10.5* ↘

beste Teiler: 56.6 (15.), 87.6 (12.), 92.0 (14.)
 Trefferlage: 0.64 mm links, 0.96 mm hoch
 Streuwert: 1.21, horizontal: 1.41, vertikal: 0.98



Ergebnis: **204.5** (195)
 Serien: 102.6 101.9
 Zähler: 16 3 1 0 0 0 0 0 0 0
 Innenzehner: 15
 Weitesten: 587 (20.), 369 (2.), 311 (5.)
 beste Teiler: 20.0 (4.), 75.2 (9.), 87.8 (15.)
 Trefferlage: 0.83 mm rechts, 0.72 mm hoch
 Streuwert: 1.39, horizontal: 1.72, vertikal: 0.95

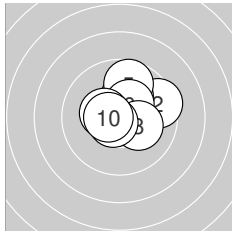
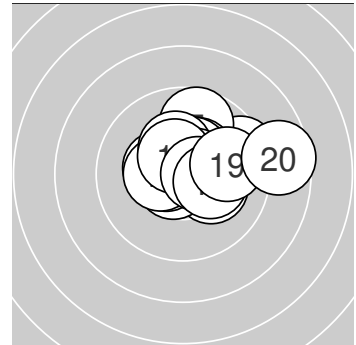

Serie 1: 102.6 (98)

10.2* ↗	9.5 →	10.1 ↗	10.9* ↓	9.7 ↗
10.4* ↗	10.4* ←	10.2* →	10.7* ↙	10.5* ←

beste Teiler: 20.0 (4.), 75.2 (9.), 102.0 (10.)
 Trefferlage: 0.52 mm rechts, 0.82 mm hoch
 Streuwert: 1.32, horizontal: 1.41, vertikal: 1.23

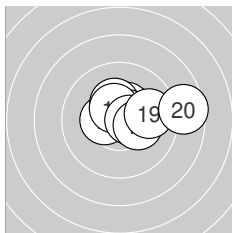

Serie 2: 101.9 (97)

10.4* ←	10.3* ↗	10.4* ↗	10.3* ↖	10.6* ↗
10.5* ↖	10.6* →	10.3* →	9.9 →	8.6 →

beste Teiler: 87.8 (15.), 90.0 (17.), 119.9 (16.)
 Trefferlage: 1.13 mm rechts, 0.62 mm hoch
 Streuwert: 1.49, horizontal: 2.01, vertikal: 0.62



Ergebnis: **189.8** (181)
 Serien: 97.4 92.4
 Zähler: 6 9 5 0 0 0 0 0 0 0 0
 Innenzehner: 4
 Weitester: 713 (11.), 699 (20.), 647 (14.)
 beste Teiler: 36.4 (19.), 105.8 (8.), 112.9 (5.)
 Trefferlage: 1.30 mm links, 0.45 mm hoch
 Streuwert: 2.82, horizontal: 3.14, vertikal: 2.47

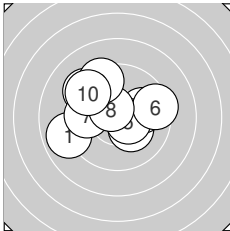
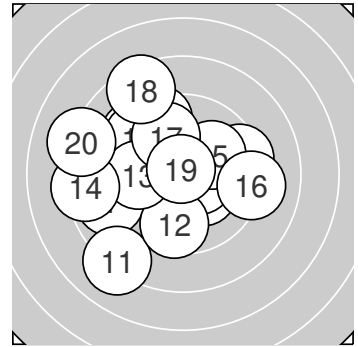

Serie 1: 97.4 (93)

8.9 ← 10.3* ↘ 9.3 ↘ 10.0 → 10.5* →
 9.4 → 9.7 ← 10.5* ↘ 9.4 ↘
 beste Teiler: 105.8 (8.), 112.9 (5.), 174.3 (2.)
 Trefferlage: 0.76 mm links, 0.80 mm hoch
 Streuwert: 2.31, horizontal: 2.79, vertikal: 1.69

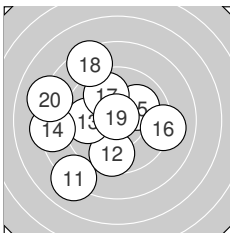

Serie 2: 92.4 (88)

8.1 ↙ 9.6 ↓ 9.8 ← 8.4 ← 10.0 ↗
 9.1 → 9.9 ↗ 8.5 ↘ 10.8* ↗ 8.2 ←
 beste Teiler: 36.4 (19.), 227.1 (15.), 272.1 (17.)
 Trefferlage: 1.85 mm links, 0.11 mm hoch
 Streuwert: 3.32, horizontal: 3.52, vertikal: 3.12



Ergebnis: **179.4** (172)
 Serien: 92.0 87.4
 Zähler: 3 9 5 3 0 0 0 0 0 0 0
 Innenzehner: 3
 Weitester: 959 (13.), 867 (16.), 770 (17.)
 beste Teiler: 109.5 (14.), 118.2 (2.), 195.1 (1.)
 Trefferlage: 0.63 mm rechts, 2.46 mm hoch
 Streuwert: 3.48, horizontal: 4.52, vertikal: 1.92

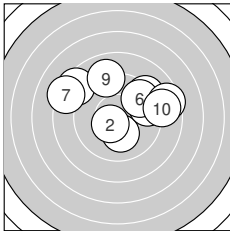
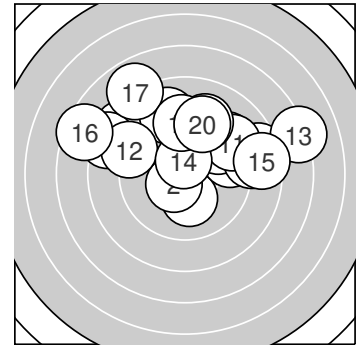

Serie 1: 92.0 (88)

10.2* ↓	10.5* ↙	9.2 ↗	9.4 →	8.5 ↖
9.6 ↗	8.3 ↖	8.5 →	9.0 ↑	8.8 →

beste Teiler: 118.2 (2.), 195.1 (1.), 347.7 (6.)
 Trefferlage: 0.76 mm rechts, 1.74 mm hoch
 Streuwert: 3.23, horizontal: 4.12, vertikal: 1.97

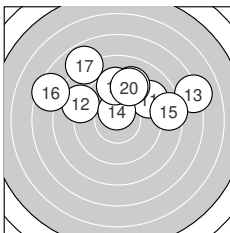

Serie 2: 87.4 (84)

9.1 ↗	9.0 ↖	7.1 →	10.5* ↑	8.5 →
7.5 ↖	7.9 ↖	9.2 ↑	9.3 ↑	9.3 ↑

beste Teiler: 109.5 (14.), 408.9 (19.), 421.2 (20.)
 Trefferlage: 0.51 mm rechts, 3.19 mm hoch
 Streuwert: 3.80, horizontal: 5.12, vertikal: 1.66



Ergebnis: **187.2** (178)
 Serien: 96.8 90.4
 Zähler: 4 11 4 1 0 0 0 0 0 0
 Innenzehner: 2
 Weitester: 846 (13.), 638 (18.), 619 (10.)
 beste Teiler: 7.0 (4.), 183.0 (3.), 221.2 (9.)
 Trefferlage: 2.71 mm rechts, 0.28 mm hoch
 Streuwert: 2.50, horizontal: 2.39, vertikal: 2.60

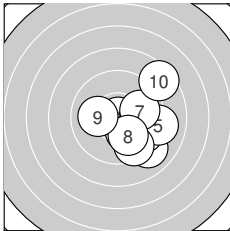
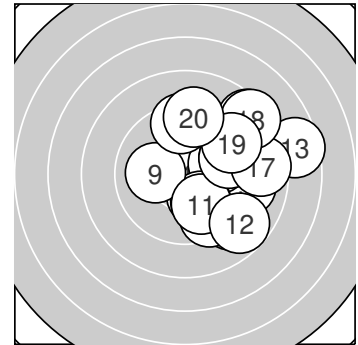

Serie 1: 96.8 (93)

9.0 ↘	9.6 ↘	10.2* ↘	10.9* →	9.1 →
9.5 ↘	9.9 →	10.0 ↘	10.1 ←	8.5 ↗

beste Teiler: 7.0 (4.), 183.0 (3.), 221.2 (9.)
 Trefferlage: 1.97 mm rechts, 0.79 mm tief
 Streuwert: 2.16, horizontal: 2.11, vertikal: 2.20

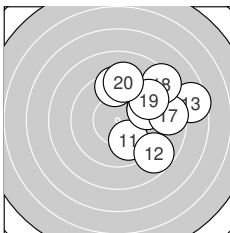

Serie 2: 90.4 (85)

9.9 ↘	8.8 ↘	7.6 →	9.5 →	9.4 ↑
9.6 →	8.7 →	8.4 ↗	9.3 ↗	9.2 ↑

beste Teiler: 255.5 (11.), 349.8 (16.), 354.8 (14.)
 Trefferlage: 3.45 mm rechts, 1.36 mm hoch
 Streuwert: 2.58, horizontal: 2.53, vertikal: 2.62



Ergebnis: **175.6** (168)
 Serien: 88.1 87.5
 Zähler: 2 8 7 2 1 0 0 0 0 0 0
 Innenzehner: 1
 Weitestе: 1057 (13.), 916 (10.), 795 (20.)
 beste Teiler: 114.1 (6.), 249.0 (16.), 342.9 (19.)
 Trefferlage: 2.50 mm rechts, 2.09 mm hoch
 Streuwert: 3.55, horizontal: 4.43, vertikal: 2.37

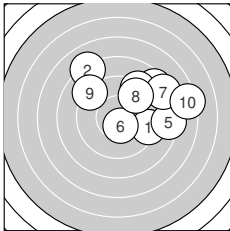
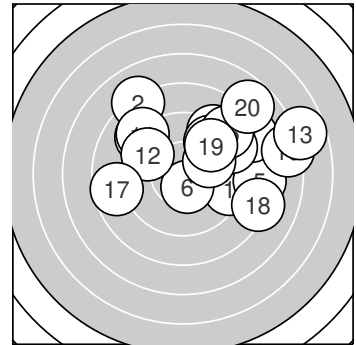

Serie 1: 88.1 (85)

9.3 → 8.1 ↖ 8.5 ↗ 9.2 ↗ 8.3 →
 10.5* ↓ 8.3 ↗ 9.5 ↗ 9.1 ↖ 7.3 →
 beste Teiler: 114.1 (6.), 360.5 (8.), 415.5 (1.)
 Trefferlage: 2.77 mm rechts, 2.19 mm hoch
 Streuwert: 3.41, horizontal: 4.16, vertikal: 2.42

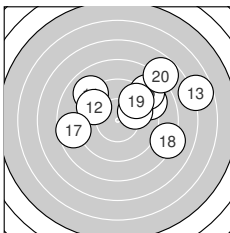

Serie 2: 87.5 (83)

9.0 ↖ 9.6 ↖ 6.7 → 9.1 ↗ 8.9 ↗
 10.0 → 8.6 ← 8.2 → 9.6 ↗ 7.8 ↗
 beste Teiler: 249.0 (16.), 342.9 (19.), 344.7 (12.)
 Trefferlage: 2.22 mm rechts, 1.98 mm hoch
 Streuwert: 3.87, horizontal: 4.89, vertikal: 2.45



ÖSB LG 20 ZR

StandNr: 110

Peintner,, Laurin #70609267

Jugend_I_männl.

Wertung

StartNr: 10

02.03.2024 10:21

SG_Lienz_SSV

Ergebnis: **0.0** (0)_{DNS}
Serien:
Zähler: 0 0 0 0 0 0 0 0 0 0 0
Innenzehner: 0
Weiteste:
~~beste Teiler~~Schütze ist nicht zum Wettkampf angetreten
Trefferlage: 0.00 mm , 0.00 mm
Streuwert:

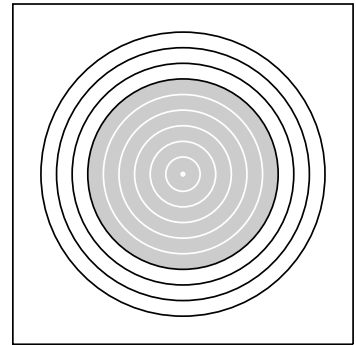

Ergebnis: **201.5** (193)
 Serien: 103.4 98.1
 Zähler: 14 5 1 0 0 0 0 0 0 0
 Innenzehner: 10
 Weitestе: 521 (15.), 460 (16.), 456 (13.)
 beste Teiler: 77.3 (20.), 79.0 (6.), 83.3 (7.)
 Trefferlage: 0.11 mm rechts, 0.12 mm hoch
 Streuwert: 1.86, horizontal: 2.08, vertikal: 1.61

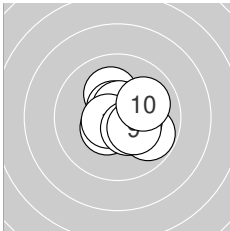
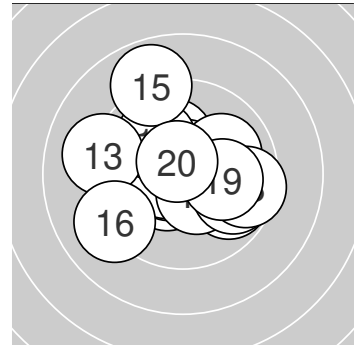

Serie 1: 103.4 (99)

9.8 ↘	10.1 ↑	10.4* →	10.6* ↖	10.5* ↙
10.6* ↑	10.6* ↙	10.5* ↘	10.3* ↘	10.0 ↗

beste Teiler: 79.0 (6.), 83.3 (7.), 83.7 (4.)
 Trefferlage: 0.58 mm rechts, 0.00 mm
 Streuwert: 1.16, horizontal: 1.24, vertikal: 1.08

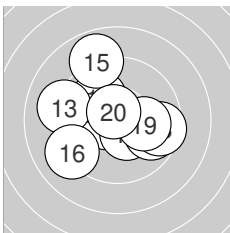

Serie 2: 98.1 (94)

10.6* ←	10.0 ↖	9.1 ←	10.4* ↘	8.9 ↑
9.1 ↙	9.8 ↘	9.5 →	10.1 →	10.6* ↖

beste Teiler: 77.3 (20.), 94.3 (11.), 132.0 (14.)
 Trefferlage: 0.35 mm links, 0.25 mm hoch
 Streuwert: 2.39, horizontal: 2.67, vertikal: 2.07



Ergebnis: **202.4** (192)
 Serien: 100.0 102.4
 Zähler: 12 8 0 0 0 0 0 0 0 0 0
 Innenzehner: 10
 Weitestе: 365 (18.), 359 (7.), 347 (10.)
 beste Teiler: 44.7 (3.), 76.1 (12.), 77.0 (17.)
 Trefferlage: 0.12 mm rechts, 0.87 mm tief
 Streuwert: 1.55, horizontal: 1.87, vertikal: 1.13

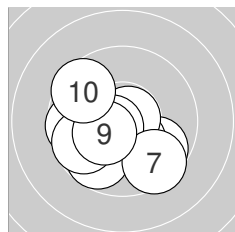
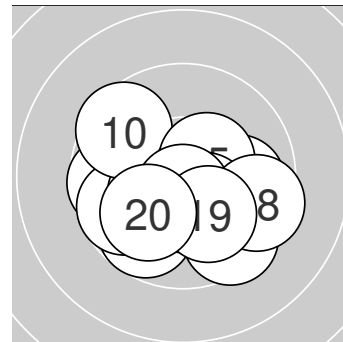

Serie 1: 100.0 (94)

9.7 ↘	10.3* ↘	10.8* →	10.6* ←	9.7 ✓
9.7 ←	9.5 ↘	9.7 ←	10.4* ←	9.6 ↘

beste Teiler: 44.7 (3.), 87.6 (4.), 150.6 (9.)
 Trefferlage: 0.66 mm links, 0.92 mm tief
 Streuwert: 1.76, horizontal: 2.02, vertikal: 1.45

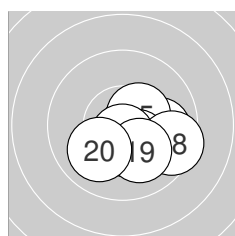

Serie 2: 102.4 (98)

10.4* ↓	10.6* →	9.9 →	10.5* ↘	10.4* →
10.4* ↘	10.6* ↓	9.5 →	10.1 ↘	10.0 ✓

beste Teiler: 76.1 (12.), 77.0 (17.), 108.9 (14.)
 Trefferlage: 0.92 mm rechts, 0.83 mm tief
 Streuwert: 1.12, horizontal: 1.38, vertikal: 0.78



Ergebnis: **202.8** (190)
 Serien: 101.7 101.1
 Zähler: 11 8 1 0 0 0 0 0 0 0
 Innenzehner: 10
 Weitesten: 530 (13.), 459 (8.), 324 (14.)
 beste Teiler: 23.4 (10.), 41.0 (3.), 56.7 (19.)
 Trefferlage: 0.69 mm links, 0.11 mm tief
 Streuwert: 1.71, horizontal: 1.95, vertikal: 1.44

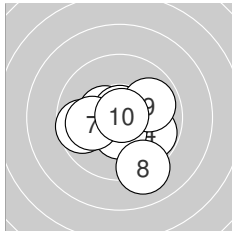
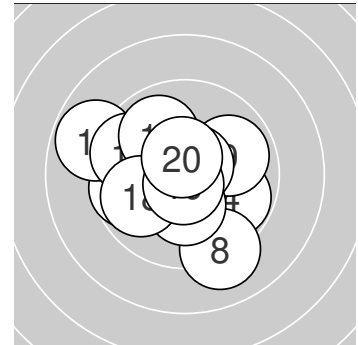

Serie 1: 101.7 (96)

10.4* ←	10.6* ↓	10.8* ↑	9.8 →	9.7 ←
10.5* ↓	10.0 ←	9.1 ↓	9.9 →	10.9* ↗

beste Teiler: 23.4 (10.), 41.0 (3.), 91.5 (2.)
 Trefferlage: 0.08 mm rechts, 0.68 mm tief
 Streuwert: 1.69, horizontal: 1.90, vertikal: 1.44

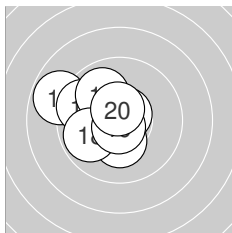

Serie 2: 101.1 (94)

9.9 ←	10.6* ↖	8.8 ←	9.7 ←	10.3* ↓
9.9 ↖	10.7* ↗	9.9 ←	10.7* ↓	10.6* ↑

beste Teiler: 56.7 (19.), 67.9 (17.), 85.2 (12.)
 Trefferlage: 1.47 mm links, 0.44 mm hoch
 Streuwert: 1.52, horizontal: 1.75, vertikal: 1.26



Ergebnis: **199.1** (190)
 Serien: 99.4 99.7
 Zähler: 11 8 1 0 0 0 0 0 0 0
 Innenzehner: 8
 Weitestе: 586 (8.), 428 (9.), 414 (16.)
 beste Teiler: 66.1 (2.), 125.2 (5.), 139.7 (6.)
 Trefferlage: 0.28 mm links, 0.39 mm tief
 Streuwert: 1.97, horizontal: 2.50, vertikal: 1.23

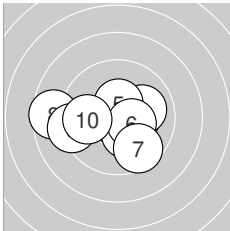
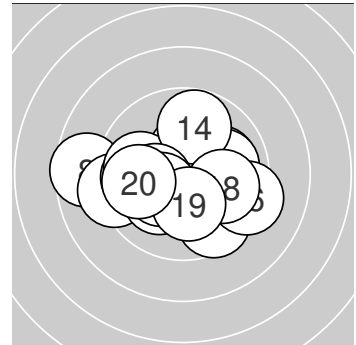

Serie 1: 99.4 (95)

10.3* →	10.7* ←	10.3* ↓	10.0 →	10.5* ↑
10.4* →	9.6 ↓	8.6 ←	9.2 ←	9.8 ←

beste Teiler: 66.1 (2.), 125.2 (5.), 139.7 (6.)
 Trefferlage: 0.57 mm links, 0.43 mm tief
 Streuwert: 2.13, horizontal: 2.78, vertikal: 1.16

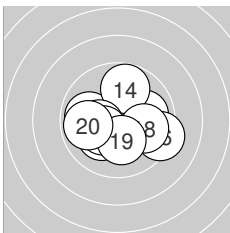

Serie 2: 99.7 (95)

9.9 ←	10.1 ↙	10.0 →	9.8 ↑	10.3* ←
9.3 →	10.3* ↘	9.9 →	10.2* ↓	9.9 ←

beste Teiler: 162.2 (17.), 172.4 (15.), 185.3 (19.)
 Trefferlage: 0.00 mm, 0.35 mm tief
 Streuwert: 1.89, horizontal: 2.31, vertikal: 1.36



ÖSB LG 20 ZR

StandNr: 115

Kopp,, Peter #70410045

Jugend_I_männl.

Wertung

StartNr: 15

02.03.2024 10:21

SG_Kramsach

Ergebnis: **0.0** (0)_{DNS}
Serien:
Zähler: 0 0 0 0 0 0 0 0 0 0 0
Innenzehner: 0
Weiteste:
~~beste Teiler~~Schütze ist nicht zum Wettkampf angetreten
Trefferlage: 0.00 mm , 0.00 mm
Streuwert:

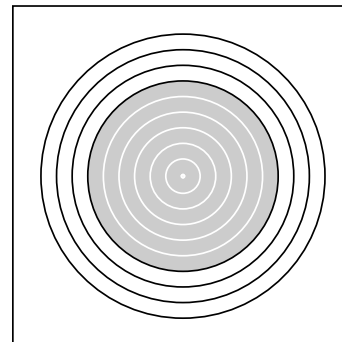

Ergebnis: **192.8** (184)
 Serien: 94.8 98.0
 Zähler: 6 12 2 0 0 0 0 0 0 0
 Innenzehner: 3
 Weitestе: 585 (8.), 562 (10.), 496 (17.)
 beste Teiler: 78.5 (13.), 104.5 (7.), 162.5 (2.)
 Trefferlage: 1.11 mm links, 0.87 mm hoch
 Streuwert: 2.39, horizontal: 2.46, vertikal: 2.31

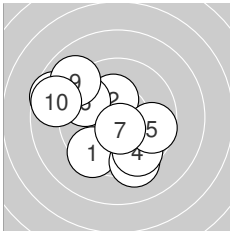
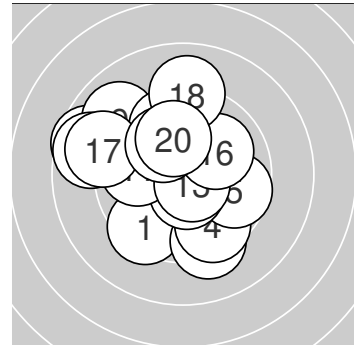

Serie 1: 94.8 (90)

9.4 ↙	10.3* ↑	9.3 ↓	9.6 ↓	9.7 →
9.7 ↖	10.5* ↓	8.6 ↖	9.0 ↖	8.7 ↖

beste Teiler: 104.5 (7.), 162.5 (2.), 318.2 (5.)
 Trefferlage: 1.37 mm links, 0.25 mm tief
 Streuwert: 2.78, horizontal: 3.05, vertikal: 2.49

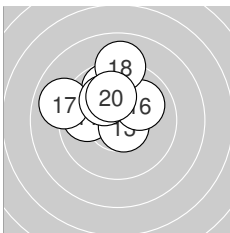

Serie 2: 98.0 (94)

9.9 ←	9.7 ↑	10.6* ↘	9.8 ↑	9.8 ↑
10.0 ↗	9.0 ↖	9.0 ↑	10.1 ↘	10.1 ↑

beste Teiler: 78.5 (13.), 211.3 (19.), 217.5 (20.)
 Trefferlage: 0.85 mm links, 2.00 mm hoch
 Streuwert: 1.67, horizontal: 1.82, vertikal: 1.51



Ergebnis: **194.8** (186)
 Serien: 94.8 100.0
 Zähler: 9 10 0 0 1 0 0 0 0 0 0
 Innenzehner: 5
 Weitester: 1075 (7.), 425 (1.), 392 (5.)
 beste Teiler: 97.0 (11.), 111.3 (8.), 127.4 (16.)
 Trefferlage: 0.42 mm rechts, 1.29 mm tief
 Streuwert: 2.44, horizontal: 3.01, vertikal: 1.67

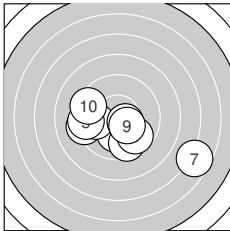
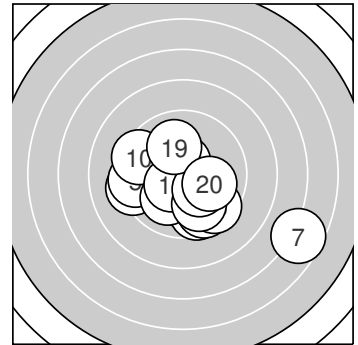

Serie 1: 94.8 (90)

9.3 ← 10.1 ↓ 9.8 ← 9.6 ↓ 9.4 ←
 9.7 ↘ 6.7 ↘ 10.5* ↘ 10.3* ↘ 9.4 ←

beste Teiler: 111.3 (8.), 154.4 (9.), 205.5 (2.)
 Trefferlage: 0.02 mm rechts, 1.48 mm tief
 Streuwert: 3.15, horizontal: 4.09, vertikal: 1.77

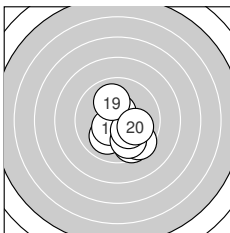

Serie 2: 100.0 (96)

10.6* ↑ 9.6 ↘ 10.0 ↙ 9.9 ↘ 9.5 ↘
 10.4* ↙ 9.8 ↘ 10.2* ↘ 10.0 ↑ 10.0 ↘

beste Teiler: 97.0 (11.), 127.4 (16.), 184.7 (18.)
 Trefferlage: 0.83 mm rechts, 1.11 mm tief
 Streuwert: 1.54, horizontal: 1.43, vertikal: 1.64



Ergebnis: **204.3** (196)
 Serien: 103.6 100.7
 Zähler: 17 2 1 0 0 0 0 0 0 0
 Innenzehner: 13
 Weitestе: 510 (15.), 303 (16.), 282 (17.)
 beste Teiler: 39.2 (14.), 67.0 (1.), 94.0 (13.)
 Trefferlage: 1.00 mm rechts, 0.26 mm tief
 Streuwert: 1.31, horizontal: 1.45, vertikal: 1.15

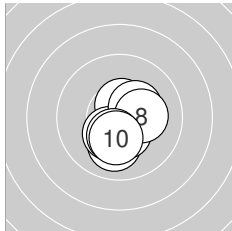
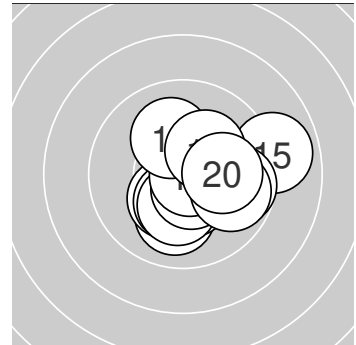

Serie 1: 103.6 (100)

10.7* →	10.0 ↓	10.6* ↑	10.5* ↓	10.4* ↓
10.3* ↙	10.3* ↗	10.2* →	10.3* ↓	10.3* ↓

beste Teiler: 67.0 (1.), 100.4 (3.), 118.7 (4.)
 Trefferlage: 0.27 mm rechts, 0.73 mm tief
 Streuwert: 0.99, horizontal: 0.84, vertikal: 1.12

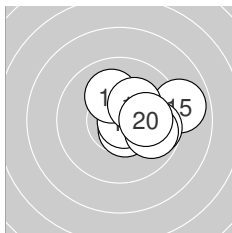

Serie 2: 100.7 (96)

10.1 →	10.4* ↗	10.6* ↓	10.8* →	8.9 →
9.7 →	9.8 →	10.1 ↑	10.2* ↗	10.1 →

beste Teiler: 39.2 (14.), 94.0 (13.), 130.1 (12.)
 Trefferlage: 1.73 mm rechts, 0.20 mm hoch
 Streuwert: 1.34, horizontal: 1.60, vertikal: 1.03



Ergebnis: **187.8** (179)
 Serien: 93.1 94.7
 Zähler: 8 5 5 2 0 0 0 0 0 0 0
 Innenzehner: 6
 Weitestе: 924 (8.), 920 (11.), 694 (17.)
 beste Teiler: 50.1 (20.), 65.1 (9.), 106.9 (3.)
 Trefferlage: 0.59 mm rechts, 0.67 mm hoch
 Streuwert: 3.32, horizontal: 4.56, vertikal: 1.15

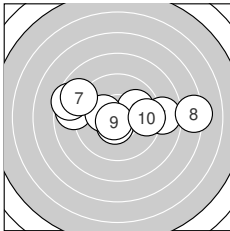
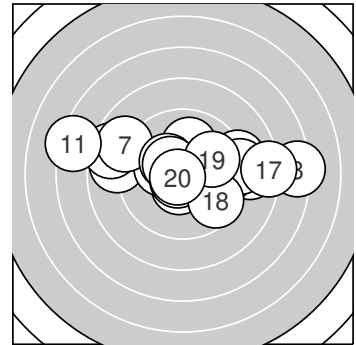

Serie 1: 93.1 (88)

8.8 ← 10.0 → 10.5* ↓
 10.2* ← 8.8 ↖ 7.3 →
 beste Teiler: 65.1 (9.), 106.9 (3.), 177.3 (6.)
 Trefferlage: 0.20 mm rechts, 0.57 mm hoch
 Streuwert: 3.56, horizontal: 4.93, vertikal: 1.04

8.5 ← 8.8 →
 10.7* ↙ 9.5 →

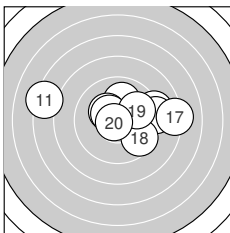

Serie 2: 94.7 (91)

7.3 ← 10.0 ↑ 10.3* ↘
 9.1 → 8.2 → 9.6 ↘
 beste Teiler: 50.1 (20.), 129.0 (15.), 164.2 (13.)
 Trefferlage: 0.98 mm rechts, 0.78 mm hoch
 Streuwert: 3.24, horizontal: 4.39, vertikal: 1.30

9.1 → 10.4* ↘
 9.9 → 10.8* ↙



Ergebnis: **192.1** (183)
 Serien: 93.5 98.6
 Zähler: 7 11 1 0 1 0 0 0 0 0 0
 Innenezehner: 4
 Weitestе: 1004 (10.), 541 (1.), 481 (2.)
 beste Teiler: 45.2 (3.), 81.7 (15.), 90.0 (12.)
 Trefferlage: 0.77 mm rechts, 0.41 mm hoch
 Streuwert: 2.79, horizontal: 3.60, vertikal: 1.64

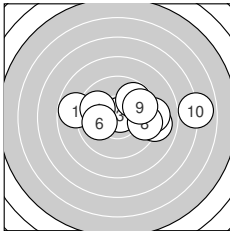
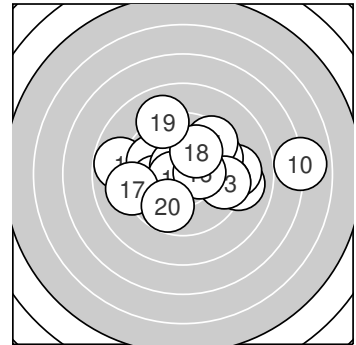

Serie 1: 93.5 (88)

8.8 ← 9.0 → 10.8* ↗
 10.0 ← 9.8 ↗ 9.5 →
 beste Teiler: 45.2 (3.), 239.9 (6.), 279.9 (4.)
 Trefferlage: 1.76 mm rechts, 0.48 mm hoch
 Streuwert: 3.21, horizontal: 4.43, vertikal: 0.99

9.8 ↖ 9.2 →
 9.7 ↗ 6.9 →

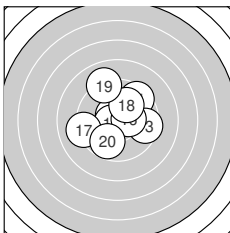

Serie 2: 98.6 (95)

9.5 ↗ 10.6* ↖ 9.5 →
 10.4* → 9.1 ← 10.1 ↗
 beste Teiler: 81.7 (15.), 90.0 (12.), 141.6 (16.)
 Trefferlage: 0.21 mm links, 0.34 mm hoch
 Streuwert: 2.25, horizontal: 2.35, vertikal: 2.16

10.0 ↖ 10.6* ←
 9.0 ↖ 9.8 ↘



Ergebnis: **194.9** (184)
 Serien: 96.8 98.1
 Zähler: 7 10 3 0 0 0 0 0 0 0 0
 Innenzehner: 7
 Weitestе: 687 (4.), 637 (13.), 502 (6.)
 beste Teiler: 45.1 (17.), 118.8 (20.), 137.7 (5.)
 Trefferlage: 0.83 mm links, 0.62 mm tief
 Streuwert: 2.39, horizontal: 2.88, vertikal: 1.76

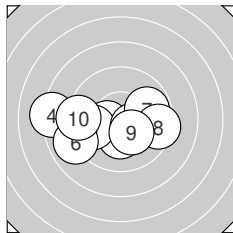
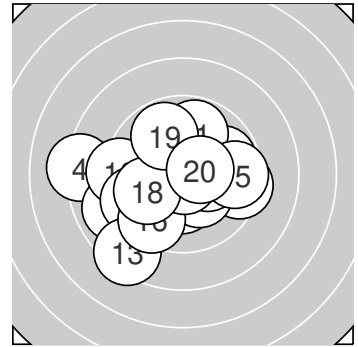

Serie 1: 96.8 (92)

10.4* ← 10.3* ↓ 9.8 ←
 8.9 ← 9.8 → 9.4 →
 beste Teiler: 137.7 (5.), 140.5 (1.), 171.1 (9.)
 Trefferlage: 1.10 mm links, 0.62 mm tief
 Streuwert: 2.53, horizontal: 3.44, vertikal: 0.99

8.2 ← 10.4* →
 10.3* ↓ 9.3 ←

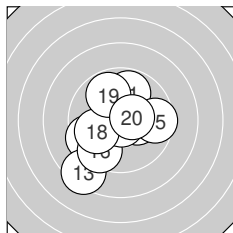

Serie 2: 98.1 (92)

9.8 ↑ 9.5 ← 8.4 ↙
 9.5 ↘ 10.8* ↓ 9.9 ←
 beste Teiler: 45.1 (17.), 118.8 (20.), 166.7 (14.)
 Trefferlage: 0.55 mm links, 0.62 mm tief
 Streuwert: 2.36, horizontal: 2.35, vertikal: 2.37

10.3* → 9.6 →
 9.8 ↘ 10.5* →



Ergebnis: **202.4** (193)
 Serien: 101.5 100.9
 Zähler: 13 7 0 0 0 0 0 0 0 0
 Innenzehner: 11
 Weitestе: 469 (3.), 423 (19.), 323 (11.)
 beste Teiler: 26.5 (6.), 77.7 (14.), 81.3 (10.)
 Trefferlage: 0.98 mm links, 0.15 mm hoch
 Streuwert: 1.58, horizontal: 1.94, vertikal: 1.10

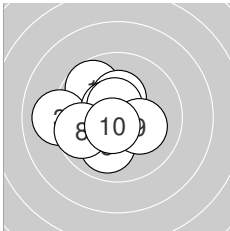
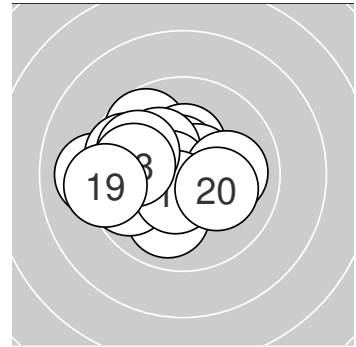

Serie 1: 101.5 (97)

9.7 ↖	10.3* ↑	9.1 ←	10.5* ↖	10.0 ↓
10.8* →	10.6* ↑	9.7 ←	10.2* →	10.6* ↓

beste Teiler: 26.5 (6.), 81.3 (10.), 98.2 (7.)
 Trefferlage: 0.96 mm links, 0.06 mm hoch
 Streuwert: 1.60, horizontal: 1.81, vertikal: 1.36

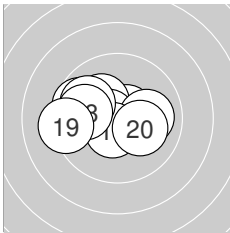

Serie 2: 100.9 (96)

9.7 ↖	10.6* ↗	10.2* ↖	10.6* ←	10.0 →
10.5* ↓	9.9 ↖	9.9 ←	9.3 ←	10.2* →

beste Teiler: 77.7 (14.), 85.9 (12.), 105.3 (16.)
 Trefferlage: 0.99 mm links, 0.23 mm hoch
 Streuwert: 1.63, horizontal: 2.15, vertikal: 0.83



Ergebnis: **159.5** (149)
 Serien: 80.8 78.7
 Zähler: 1 5 6 4 1 1 1 1 0 0 0
 Innenzehner: 1
 Weitester: 1862 (20.), 1574 (3.), 1444 (7.)
 beste Teiler: 95.6 (4.), 254.1 (9.), 286.8 (12.)
 Trefferlage: 1.69 mm rechts, 4.00 mm tief
 Streuwert: 5.45, horizontal: 6.83, vertikal: 3.57

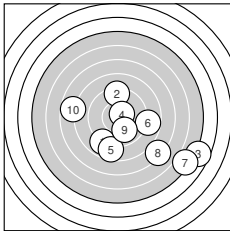
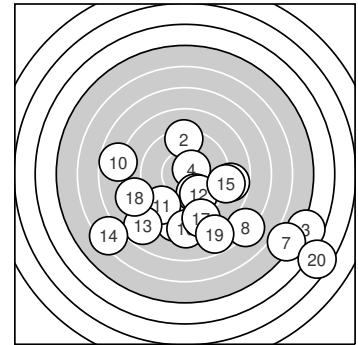

Serie 1: 80.8 (75)

8.9 ↙	9.3 ↑	4.7 →	10.6* ↗	8.6 ↓
8.8 →	5.2 ↘	7.1 ↘	9.9 ↓	7.7 ←

beste Teiler: 95.6 (4.), 254.1 (9.), 419.2 (2.)
 Trefferlage: 2.89 mm rechts, 2.78 mm tief
 Streuwert: 5.61, horizontal: 6.83, vertikal: 4.03

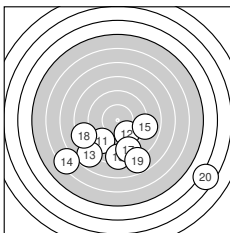

Serie 2: 78.7 (74)

9.1 ↙	9.8 ↘	7.8 ↙	6.3 ↙	9.0 →
8.4 ↓	8.7 ↓	8.3 ←	7.8 ↓	3.5 ↘

beste Teiler: 286.8 (12.), 459.2 (11.), 500.1 (15.)
 Trefferlage: 0.49 mm rechts, 5.21 mm tief
 Streuwert: 5.29, horizontal: 6.96, vertikal: 2.73



Ergebnis: **196.9** (188)
 Serien: 98.1 98.8
 Zähler: 8 12 0 0 0 0 0 0 0 0
 Innenzehner: 4
 Weitestе: 485 (19.), 449 (9.), 430 (3.)
 beste Teiler: 80.9 (5.), 112.3 (17.), 112.6 (4.)
 Trefferlage: 0.83 mm links, 0.03 mm hoch
 Streuwert: 2.08, horizontal: 2.10, vertikal: 2.06

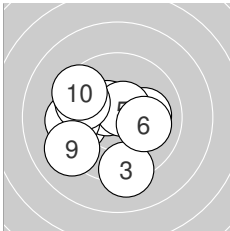
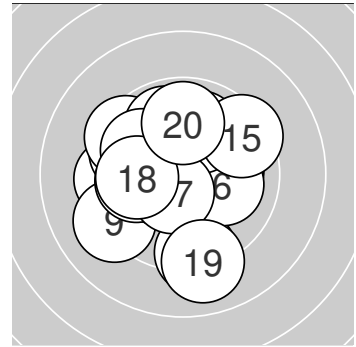

Serie 1: 98.1 (94)

10.1 →	9.7 ←	9.2 ↓	10.5* ↖	10.6* ↗
10.1 →	9.5 ←	9.7 ↖	9.2 ↖	9.5 ↖

beste Teiler: 80.9 (5.), 112.6 (4.), 214.5 (1.)
 Trefferlage: 1.18 mm links, 0.33 mm tief
 Streuwert: 2.13, horizontal: 2.38, vertikal: 1.84

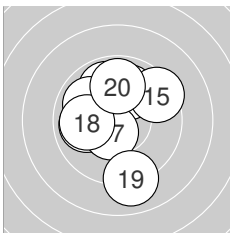

Serie 2: 98.8 (94)

10.4* ↖	9.9 ↗	10.0 ↗	9.9 ←	9.4 ↗
9.9 ↖	10.5* ↘	10.0 ←	9.0 ↓	9.8 ↑

beste Teiler: 112.3 (17.), 132.4 (11.), 244.7 (13.)
 Trefferlage: 0.48 mm links, 0.41 mm hoch
 Streuwert: 2.07, horizontal: 1.83, vertikal: 2.29



Ergebnis: **200.2** (192)
 Serien: 99.2 101.0
 Zähler: 12 8 0 0 0 0 0 0 0 0 0
 Innenzehner: 9
 Weitester: 492 (14.), 360 (4.), 354 (9.)
 beste Teiler: 66.0 (3.), 98.0 (1.), 110.1 (19.)
 Trefferlage: 0.83 mm links, 0.60 mm tief
 Streuwert: 1.71, horizontal: 2.01, vertikal: 1.35

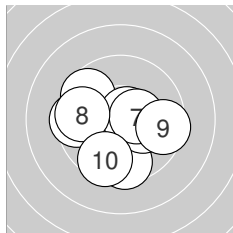
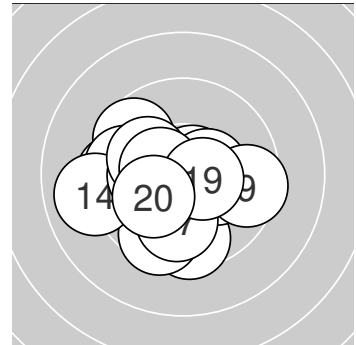

Serie 1: 99.2 (94)

10.6* →	9.6 ↖	10.7* ↗	9.5 ←	9.5 ↓
10.2* →	10.4* →	9.7 ←	9.5 →	9.5 ↓

beste Teiler: 66.0 (3.), 98.0 (1.), 133.0 (7.)
 Trefferlage: 0.22 mm links, 0.47 mm tief
 Streuwert: 2.04, horizontal: 2.35, vertikal: 1.68

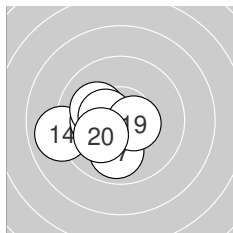

Serie 2: 101.0 (98)

10.4* ↙	10.3* ↙	10.1 ←	9.0 ←	10.2* ←
10.1 ↖	9.9 ↓	10.4* ←	10.5* →	10.1 ↙

beste Teiler: 110.1 (19.), 127.5 (18.), 143.0 (11.)
 Trefferlage: 1.43 mm links, 0.74 mm tief
 Streuwert: 1.26, horizontal: 1.49, vertikal: 0.97



Ergebnis: **208.7** (198)
 Serien: 104.0 104.7
 Zähler: 18 2 0 0 0 0 0 0 0 0 0
 Innenzehner: 16
 Weiteste: 293 (7.), 261 (10.), 241 (19.)
 beste Teiler: 30.8 (12.), 43.0 (9.), 44.2 (13.)
 Trefferlage: 0.13 mm links, 0.46 mm tief
 Streuwert: 1.05, horizontal: 1.10, vertikal: 0.99

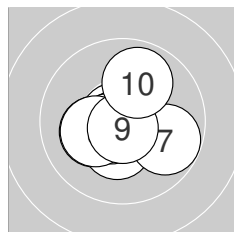
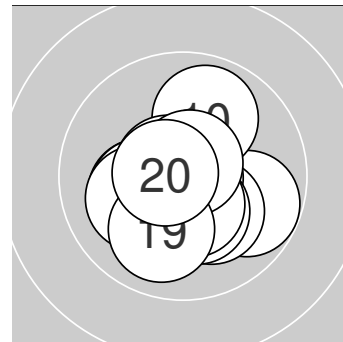

Serie 1: 104.0 (98)

10.2* ←	10.4* ↓	10.6* →	10.8* ↖	10.7* ↙
10.6* ↙	9.8 ↘	10.2* ←	10.8* ↓	9.9 ↗

beste Teiler: 43.0 (9.), 49.7 (4.), 63.2 (5.)
 Trefferlage: 0.10 mm links, 0.25 mm tief
 Streuwert: 1.20, horizontal: 1.33, vertikal: 1.06

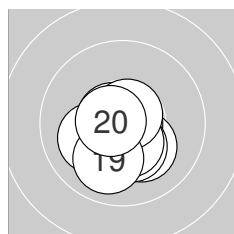

Serie 2: 104.7 (100)

10.2* ↘	10.8* →	10.8* ↙	10.7* ↖	10.3* ↓
10.1 ↙	10.5* ↓	10.7* ↗	10.0 ↙	10.6* ←

beste Teiler: 30.8 (12.), 44.2 (13.), 62.1 (18.)
 Trefferlage: 0.16 mm links, 0.67 mm tief
 Streuwert: 0.91, horizontal: 0.89, vertikal: 0.93



Ergebnis: **192.5** (183)
 Serien: 98.0 94.5
 Zähler: 8 7 5 0 0 0 0 0 0 0
 Innenzehner: 5
 Weitestе: 659 (12.), 611 (19.), 584 (11.)
 beste Teiler: 106.1 (15.), 145.1 (7.), 161.7 (13.)
 Trefferlage: 1.15 mm links, 0.01 mm hoch
 Streuwert: 2.57, horizontal: 3.02, vertikal: 2.03

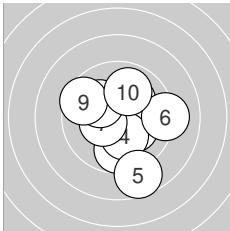
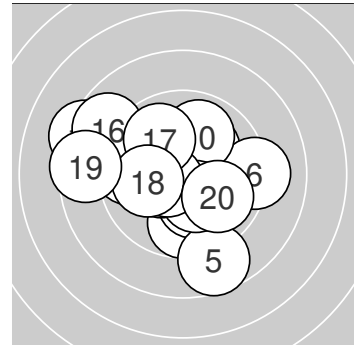

Serie 1: 98.0 (94)

9.7 ↓ 10.1 ↗ 10.2* ↘
 9.2 → 10.4* ← 10.1 ↖
 beste Teiler: 145.1 (7.), 186.6 (3.), 187.6 (4.)
 Trefferlage: 0.47 mm rechts, 0.48 mm tief
 Streuwert: 2.28, horizontal: 2.16, vertikal: 2.40

10.2* ↓ 8.7 ↓
 9.5 ↖ 9.9 ↗

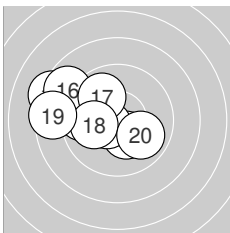

Serie 2: 94.5 (89)

8.6 ← 8.3 ↖ 10.3* ↘
 8.8 ↖ 9.9 ↖ 10.1 ←
 beste Teiler: 106.1 (15.), 161.7 (13.), 225.1 (18.)
 Trefferlage: 2.77 mm links, 0.52 mm hoch
 Streuwert: 2.35, horizontal: 2.95, vertikal: 1.52

9.6 ← 10.5* ←
 8.5 ← 9.9 ↘



Ergebnis: **208.4** (199)
 Serien: 104.3 104.1
 Zähler: 19 1 0 0 0 0 0 0 0 0 0
 Innenzehner: 17
 Weitesten: 285 (17.), 218 (9.), 201 (6.)
 beste Teiler: 68.0 (20.), 76.4 (11.), 80.0 (19.)
 Trefferlage: 0.15 mm links, 0.55 mm hoch
 Streuwert: 0.95, horizontal: 1.02, vertikal: 0.87

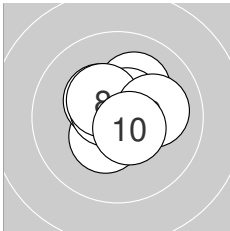
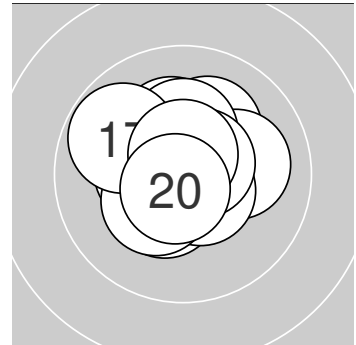

Serie 1: 104.3 (100)

10.4* ↙	10.5* ↘	10.4* ↘	10.6* ↗	10.6* ↘
10.1 ↗	10.6* ↗	10.4* ↘	10.1 →	10.6* ↘

beste Teiler: 81.8 (5.), 96.6 (7.), 98.3 (10.)
 Trefferlage: 0.13 mm rechts, 0.51 mm hoch
 Streuwert: 0.96, horizontal: 1.06, vertikal: 0.86

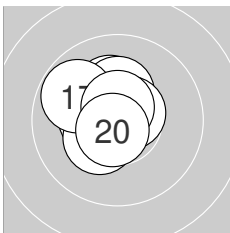

Serie 2: 104.1 (99)

10.6* ↑	10.4* ←	10.6* ↗	10.2* ↑	10.3* ↑
10.3* ↙	9.8 ↘	10.6* ↗	10.6* ↑	10.7* ↙

beste Teiler: 68.0 (20.), 76.4 (11.), 80.0 (19.)
 Trefferlage: 0.44 mm links, 0.59 mm hoch
 Streuwert: 0.94, horizontal: 0.95, vertikal: 0.93



Ergebnis: **203.3** (195)
 Serien: 101.6 101.7
 Zähler: 15 5 0 0 0 0 0 0 0 0 0
 Innenzehner: 10
 Weitestе: 470 (2.), 455 (19.), 280 (12.)
 beste Teiler: 18.0 (13.), 31.4 (4.), 35.4 (14.)
 Trefferlage: 0.01 mm rechts, 0.47 mm tief
 Streuwert: 1.62, horizontal: 2.09, vertikal: 0.94

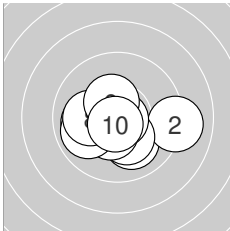
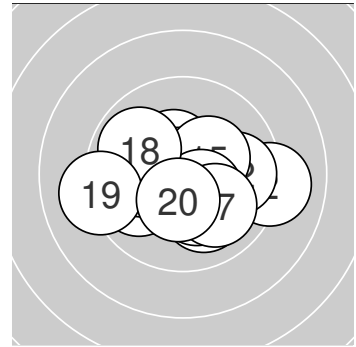

Serie 1: 101.6 (98)

10.0 ↘	9.1 →	10.2* ↘	10.8* ↘	10.4* ↙
10.0 ←	9.9 ↙	10.1 ←	10.4* ↗	10.7* ↙

beste Teiler: 31.4 (4.), 59.1 (10.), 132.7 (9.)
 Trefferlage: 0.13 mm links, 0.64 mm tief
 Streuwert: 1.62, horizontal: 2.11, vertikal: 0.90

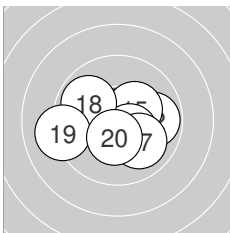

Serie 2: 101.7 (97)

10.1 ↗	9.8 →	10.9* ↑	10.8* ↘	10.3* ↗
10.4* ↘	10.0 ↘	9.9 ↘	9.1 ←	10.4* ↙

beste Teiler: 18.0 (13.), 35.4 (14.), 134.4 (16.)
 Trefferlage: 0.15 mm rechts, 0.30 mm tief
 Streuwert: 1.69, horizontal: 2.17, vertikal: 1.00



Ergebnis: **177.7** (167)
 Serien: 88.0 89.7
 Zähler: 6 3 7 1 2 1 0 0 0 0 0
 Innenzehner: 5
 Weitester: 1278 (11.), 1028 (4.), 1012 (1.)
 beste Teiler: 41.3 (2.), 74.1 (10.), 113.0 (20.)
 Trefferlage: 1.40 mm links, 0.38 mm hoch
 Streuwert: 4.36, horizontal: 5.77, vertikal: 2.15

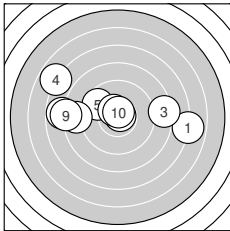
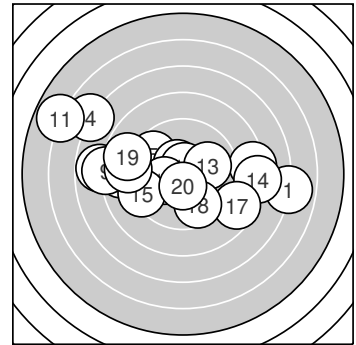

Serie 1: 88.0 (82)

6.9 → 10.8* ↗ 8.3 → 6.8 ↖ 9.6 ↖
 8.6 ← 7.8 ← 10.5* ↘ 8.0 ← 10.7* ↑

beste Teiler: 41.3 (2.), 74.1 (10.), 115.0 (8.)
 Trefferlage: 1.61 mm links, 0.94 mm hoch
 Streuwert: 4.61, horizontal: 6.28, vertikal: 1.77

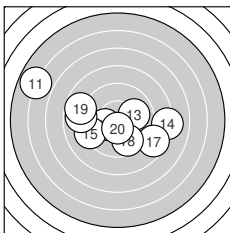

Serie 2: 89.7 (85)

5.8 ↖ 10.2* ← 10.0 → 8.1 → 9.2 ←
 8.9 ← 8.6 ↘ 9.7 ↘ 8.7 ← 10.5* ↓

beste Teiler: 113.0 (20.), 187.2 (12.), 246.3 (13.)
 Trefferlage: 1.18 mm links, 0.16 mm tief
 Streuwert: 4.29, horizontal: 5.56, vertikal: 2.44



Ergebnis: **199.8** (191)
 Serien: 98.7 101.1
 Zähler: 12 7 1 0 0 0 0 0 0 0 0
 Innenzehner: 8
 Weitesten: 661 (3.), 346 (18.), 343 (2.)
 beste Teiler: 77.2 (1.), 103.4 (17.), 120.0 (4.)
 Trefferlage: 0.80 mm links, 0.62 mm hoch
 Streuwert: 1.81, horizontal: 2.17, vertikal: 1.37

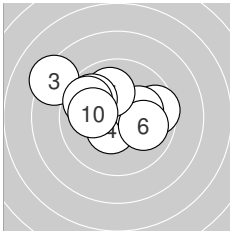
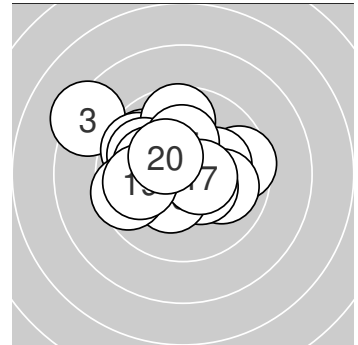

Serie 1: 98.7 (95)

10.6* →	9.6 →	8.3 ↖	10.5* ↙	10.2* →
10.0 →	10.0 ↑	9.8 ↖	9.7 ↖	10.0 ←

beste Teiler: 77.2 (1.), 120.0 (4.), 197.4 (5.)
 Trefferlage: 0.58 mm links, 0.84 mm hoch
 Streuwert: 2.17, horizontal: 2.76, vertikal: 1.35

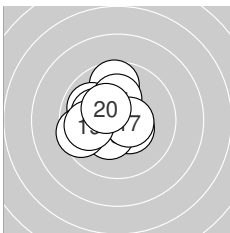

Serie 2: 101.1 (96)

9.7 ↑	9.9 ↖	10.1 ←	10.4* ↘	10.2* ↑
10.4* ↙	10.5* →	9.6 ←	9.9 ←	10.4* ↖

beste Teiler: 103.4 (17.), 131.0 (14.), 147.8 (16.)
 Trefferlage: 1.02 mm links, 0.41 mm hoch
 Streuwert: 1.46, horizontal: 1.49, vertikal: 1.43



Ergebnis: **195.9** (188)
 Serien: 97.0 98.9
 Zähler: 9 10 1 0 0 0 0 0 0 0
 Innenzehner: 6
 Weitestе: 686 (10.), 497 (4.), 469 (11.)
 beste Teiler: 47.1 (17.), 75.2 (19.), 96.7 (16.)
 Trefferlage: 0.77 mm links, 0.56 mm tief
 Streuwert: 2.30, horizontal: 3.03, vertikal: 1.16

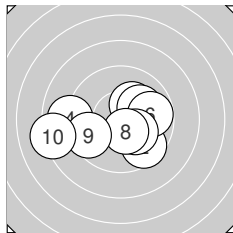
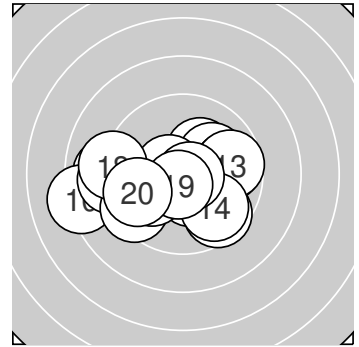

Serie 1: 97.0 (94)

10.0 → 9.6 ↘ 10.2* ↗
 9.8 → 10.2* ↘ 10.4* ↓
 beste Teiler: 129.4 (8.), 183.2 (3.), 190.7 (7.)
 Trefferlage: 0.23 mm links, 0.49 mm tief
 Streuwert: 2.59, horizontal: 3.41, vertikal: 1.33

9.0 ← 10.1 ↗
 9.5 ← 8.2 ←

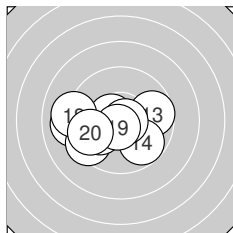

Serie 2: 98.9 (94)

9.1 ← 9.4 ↙ 9.7 →
 10.6* ← 10.8* → 9.1 ←
 beste Teiler: 47.1 (17.), 75.2 (19.), 96.7 (16.)
 Trefferlage: 1.30 mm links, 0.63 mm tief
 Streuwert: 2.02, horizontal: 2.66, vertikal: 1.04

9.8 ↘ 10.0 ↙
 10.7* ↓ 9.7 ←



Ergebnis: **205.3** (196)
 Serien: 102.8 102.5
 Zähler: 17 2 1 0 0 0 0 0 0 0
 Innenzehner: 14
 Weitester: 510 (15.), 273 (7.), 268 (18.)
 beste Teiler: 10.0 (11.), 78.5 (16.), 87.4 (2.)
 Trefferlage: 0.09 mm rechts, 0.16 mm tief
 Streuwert: 1.46, horizontal: 1.56, vertikal: 1.35

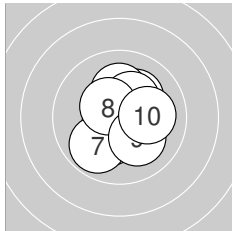
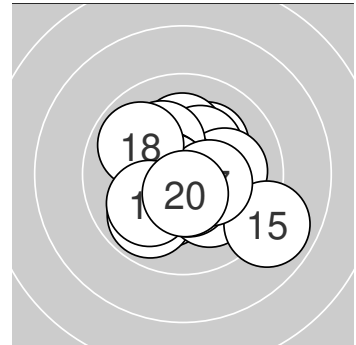

Serie 1: 102.8 (99)

10.6* →	10.6* ↙	10.2* ↗	10.2* ↑	10.3* ↗
10.3* ↙	9.9 ↙	10.5* ↘	10.1 ↘	10.1 →

beste Teiler: 87.4 (2.), 92.3 (1.), 123.0 (8.)
 Trefferlage: 0.23 mm rechts, 0.04 mm hoch
 Streuwert: 1.34, horizontal: 1.24, vertikal: 1.44

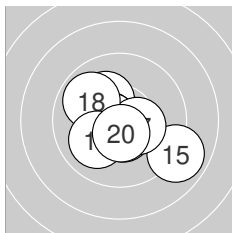

Serie 2: 102.5 (97)

10.9* ↓	10.2* ↘	10.6* ←	10.5* ↓	8.9 ↘
10.6* ←	10.4* →	9.9 ↘	10.0 ↙	10.5* ↓

beste Teiler: 10.0 (11.), 78.5 (16.), 91.0 (13.)
 Trefferlage: 0.05 mm links, 0.37 mm tief
 Streuwert: 1.61, horizontal: 1.88, vertikal: 1.29



Ergebnis: **171.9** (164)
 Serien: 91.5 80.4
 Zähler: 5 6 3 3 1 1 1 0 0 0 0
 Innenzehner: 3
 Weitester: 1548 (17.), 1316 (19.), 1104 (8.)
 beste Teiler: 100.4 (6.), 146.5 (16.), 189.9 (1.)
 Trefferlage: 2.73 mm links, 1.81 mm hoch
 Streuwert: 4.58, horizontal: 5.86, vertikal: 2.75

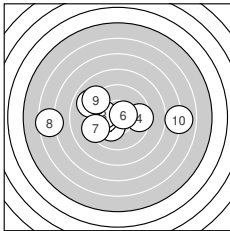
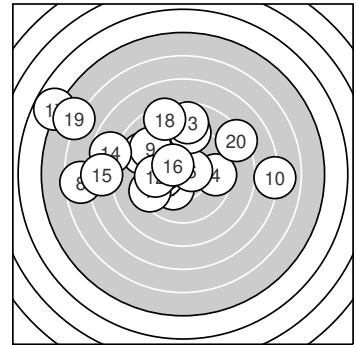

Serie 1: 91.5 (89)

10.2* ↙ 10.1 ← 10.0 ←
 10.6* → 9.4 ↙ 6.5 ←

9.5 → 9.0 ↘
 9.2 ↘ 7.0 →

beste Teiler: 100.4 (6.), 189.9 (1.), 222.7 (2.)
 Trefferlage: 1.36 mm links, 0.07 mm hoch
 Streuwert: 4.01, horizontal: 5.47, vertikal: 1.48

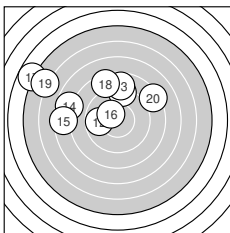

Serie 2: 80.4 (75)

9.1 ↑ 9.8 ← 8.7 ↑
 10.4* ↘ 4.8 ↘ 8.5 ↑

7.7 ↖ 7.5 ←
 5.7 ↖ 8.2 ↗

beste Teiler: 146.5 (16.), 296.8 (12.), 454.4 (11.)
 Trefferlage: 4.11 mm links, 3.54 mm hoch
 Streuwert: 4.76, horizontal: 6.19, vertikal: 2.66



Ergebnis: **195.9** (187)
 Serien: 98.4 97.5
 Zähler: 8 11 1 0 0 0 0 0 0 0
 Innenzehner: 7
 Weitestе: 507 (14.), 484 (9.), 472 (10.)
 beste Teiler: 96.1 (18.), 114.5 (20.), 116.7 (5.)
 Trefferlage: 0.19 mm rechts, 0.06 mm hoch
 Streuwert: 2.36, horizontal: 2.92, vertikal: 1.62

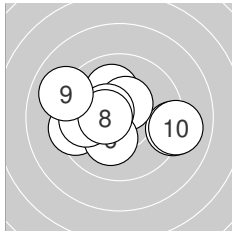
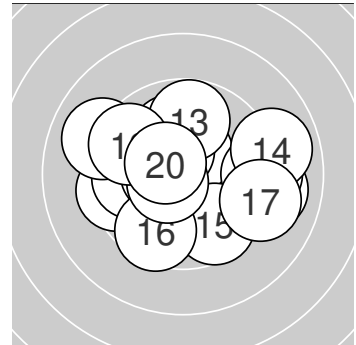

Serie 1: 98.4 (95)

10.1 ↗ 9.5 ← 9.2 →
 10.2* ↘ 9.8 ← 10.5* ←
 beste Teiler: 116.7 (5.), 120.0 (8.), 123.9 (4.)
 Trefferlage: 0.49 mm links, 0.11 mm hoch
 Streuwert: 2.34, horizontal: 3.04, vertikal: 1.30

10.5* ↗ 10.5* ↖
 9.0 ↖ 9.1 →

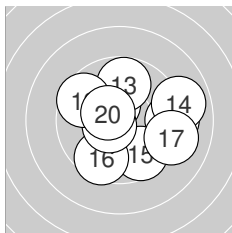

Serie 2: 97.5 (92)

9.2 → 10.4* ↗ 9.8 ↑
 9.6 ↘ 9.2 ↘ 10.6* ←
 beste Teiler: 96.1 (18.), 114.5 (20.), 139.6 (12.)
 Trefferlage: 0.87 mm rechts, 0.01 mm hoch
 Streuwert: 2.41, horizontal: 2.77, vertikal: 1.97

8.9 → 9.7 ↘
 9.6 ↖ 10.5* ↖



ÖSB LG 20 ZR

Jugend_I_männl.

StartNr: 36

StandNr: 136

Wertung

02.03.2024 10:21

Fuschlberger,, Jacob #70311109

SG_Pillersee

Ergebnis: **0.0** (0)_{DNS}
Serien:
Zähler: 0 0 0 0 0 0 0 0 0 0 0
Innenzehner: 0
Weiteste:
~~beste Teiler~~
Trefferlage: 0.00 mm , 0.00 mm
Streuwert:

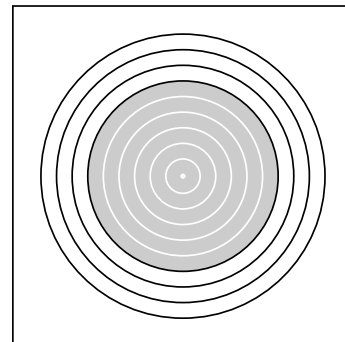

Ergebnis: **193.4** (186)
 Serien: 95.7 97.7
 Zähler: 7 12 1 0 0 0 0 0 0 0
 Innenzehner: 4
 Weitestе: 658 (3.), 496 (14.), 455 (19.)
 beste Teiler: 124.8 (1.), 147.1 (13.), 184.1 (18.)
 Trefferlage: 0.37 mm rechts, 0.49 mm tief
 Streuwert: 2.45, horizontal: 2.67, vertikal: 2.21

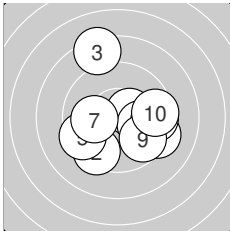
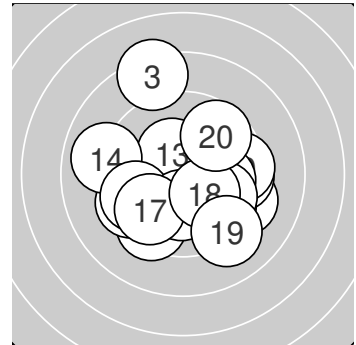

Serie 1: 95.7 (92)

10.5* → 9.4 ↙ 8.3 ↑
 10.0 → 10.1 ← 9.5 →
 beste Teiler: 124.8 (1.), 221.8 (7.), 228.7 (6.)
 Trefferlage: 0.71 mm rechts, 0.24 mm tief
 Streuwert: 2.69, horizontal: 2.79, vertikal: 2.59

9.3 → 9.4 ↙
 9.7 ↘ 9.5 →

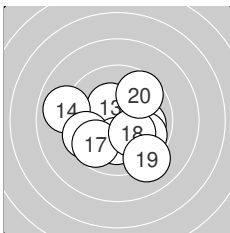

Serie 2: 97.7 (94)

10.0 → 9.8 ↘ 10.4* ↖
 10.2* ↓ 9.7 ↙ 10.2* ↘
 beste Teiler: 147.1 (13.), 184.1 (18.), 197.2 (16.)
 Trefferlage: 0.03 mm rechts, 0.75 mm tief
 Streuwert: 2.28, horizontal: 2.65, vertikal: 1.85

9.0 ← 9.6 ↙
 9.1 ↘ 9.7 ↗



Ergebnis: **200.3** (193)
 Serien: 99.7 100.6
 Zähler: 14 5 1 0 0 0 0 0 0 0 0
 Innenzehner: 7
 Weitesten: 598 (2.), 424 (12.), 350 (19.)
 beste Teiler: 89.0 (16.), 91.2 (13.), 100.1 (10.)
 Trefferlage: 0.81 mm rechts, 0.05 mm tief
 Streuwert: 1.83, horizontal: 1.89, vertikal: 1.77

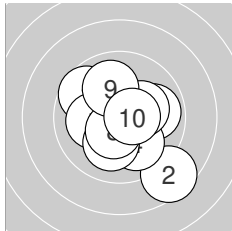
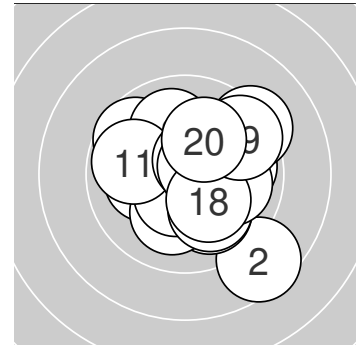

Serie 1: 99.7 (96)

9.7 ↖ 8.6 ↘ 9.9 →
 10.1 ↓ 10.2* ↗ 10.5* ↓
 beste Teiler: 100.1 (10.), 116.3 (8.), 183.2 (7.)
 Trefferlage: 0.40 mm rechts, 0.46 mm tief
 Streuwert: 2.05, horizontal: 2.07, vertikal: 2.02

10.0 ↘ 10.1 ←
 10.0 ↖ 10.6* →

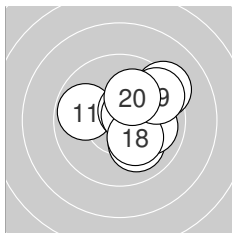

Serie 2: 100.6 (97)

9.8 ← 9.3 ↗ 10.6* ↗
 10.6* ↗ 10.0 → 10.2* ↘
 beste Teiler: 89.0 (16.), 91.2 (13.), 147.3 (15.)
 Trefferlage: 1.22 mm rechts, 0.35 mm hoch
 Streuwert: 1.57, horizontal: 1.68, vertikal: 1.45

10.0 ↘ 10.4* ↘
 9.6 ↗ 10.1 ↗



ÖSB LG 20 ZR

StandNr: 139

Hallbrucker,, Simon #70309112

Jugend_I_männl.

Wertung

StartNr: 39

02.03.2024 10:21

SG_Kössen

Ergebnis: **0.0** (0)_{DNS}
Serien:
Zähler: 0 0 0 0 0 0 0 0 0 0 0
Innenzehner: 0
Weiteste:
~~beste Teiler~~Schütze ist nicht zum Wettkampf angetreten
Trefferlage: 0.00 mm , 0.00 mm
Streuwert:

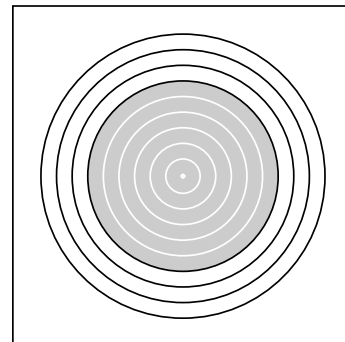

ÖSB LG 20 ZR

StandNr: 140

Hauser,, Lukas #70302109

Jugend_I_männl.

Wertung

StartNr: 40

02.03.2024 10:21

SG_Fieberbrunn

Ergebnis: **0.0** (0)_{DNS}
Serien:
Zähler: 0 0 0 0 0 0 0 0 0 0 0
Innenzehner: 0
Weiteste:
~~beste Teiler~~Schütze ist nicht zum Wettkampf angetreten
Trefferlage: 0.00 mm , 0.00 mm
Streuwert:

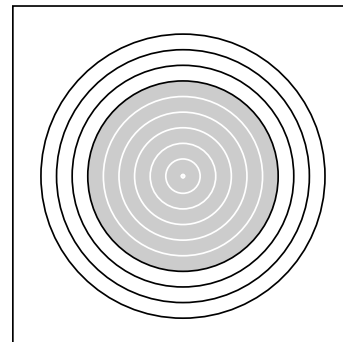

Ergebnis: **199.7** (189)
 Serien: 99.3 100.4
 Zähler: 9 11 0 0 0 0 0 0 0 0
 Innenzehner: 8
 Weitestе: 466 (13.), 429 (1.), 363 (8.)
 beste Teiler: 72.1 (4.), 103.2 (18.), 107.5 (6.)
 Trefferlage: 0.08 mm links, 1.01 mm hoch
 Streuwert: 1.76, horizontal: 2.14, vertikal: 1.28

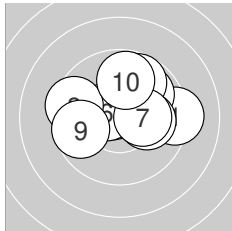
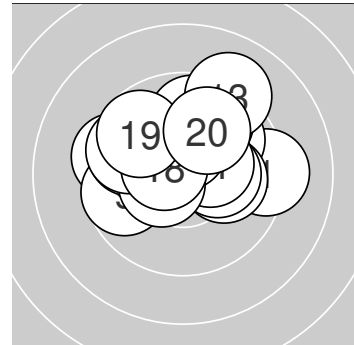

Serie 1: 99.3 (94)

9.2 →	9.9 ↗	10.1 →	10.7* ↖	9.7 ↗
10.5* ↖	10.2* →	9.5 ↖	9.7 ←	9.8 ↑

beste Teiler: 72.1 (4.), 107.5 (6.), 179.0 (7.)
 Trefferlage: 0.40 mm rechts, 0.80 mm hoch
 Streuwert: 1.94, horizontal: 2.44, vertikal: 1.26

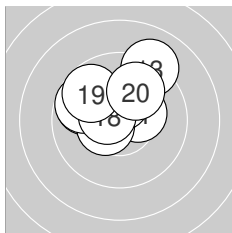

Serie 2: 100.4 (95)

10.3* →	10.5* ←	9.1 ↗	9.8 ↖	10.4* ↑
10.5* ←	9.7 ↖	10.5* ↖	9.7 ↖	9.9 ↗

beste Teiler: 103.2 (18.), 117.8 (12.), 120.0 (16.)
 Trefferlage: 0.57 mm links, 1.22 mm hoch
 Streuwert: 1.58, horizontal: 1.79, vertikal: 1.34



Ergebnis: **197.2** (188)
 Serien: 93.1 104.1
 Zähler: 10 8 2 0 0 0 0 0 0 0
 Innenzehner: 10
 Weitesten: 682 (1.), 521 (8.), 500 (5.)
 beste Teiler: 72.0 (15.), 83.6 (16.), 84.5 (11.)
 Trefferlage: 1.33 mm rechts, 0.98 mm tief
 Streuwert: 2.02, horizontal: 2.62, vertikal: 1.15

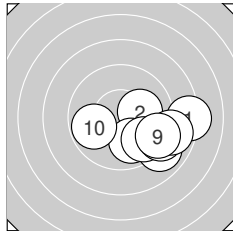
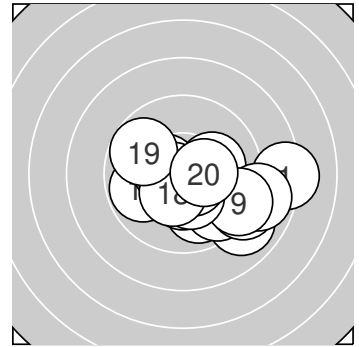

Serie 1: 93.1 (89)

8.2 →	10.2* →	9.0 →	9.9 ↓	9.0 ↘
9.7 ↘	9.1 ↘	8.9 →	9.3 →	9.8 ←

beste Teiler: 200.6 (2.), 256.0 (4.), 280.8 (10.)
 Trefferlage: 3.04 mm rechts, 1.54 mm tief
 Streuwert: 1.99, horizontal: 2.59, vertikal: 1.10

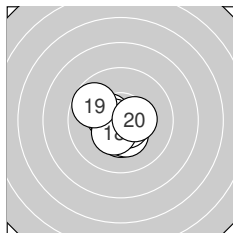

Serie 2: 104.1 (99)

10.6* ↙	10.4* ↓	10.4* ←	10.3* ↓	10.7* ←
10.6* ↘	10.6* ↙	10.4* ↙	9.7 ↖	10.4* →

beste Teiler: 72.0 (15.), 83.6 (16.), 84.5 (11.)
 Trefferlage: 0.37 mm links, 0.41 mm tief
 Streuwert: 1.02, horizontal: 1.11, vertikal: 0.92



Ergebnis: **203.6** (193)
 Serien: 101.0 102.6
 Zähler: 14 5 1 0 0 0 0 0 0 0
 Innenzehner: 12
 Weitesten: 709 (10.), 288 (4.), 281 (12.)
 beste Teiler: 54.1 (6.), 59.9 (7.), 66.6 (14.)
 Trefferlage: 0.56 mm links, 0.15 mm tief
 Streuwert: 1.68, horizontal: 2.27, vertikal: 0.70

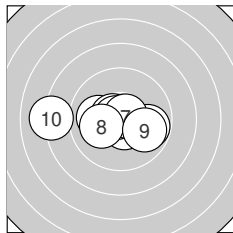
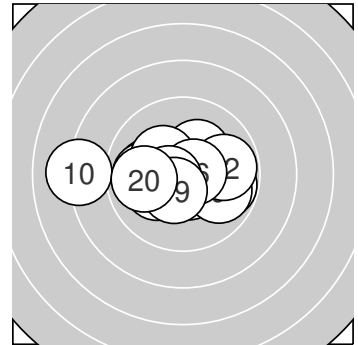

Serie 1: 101.0 (96)

10.0 ←	10.5* ↘	10.6* ↖	9.8 →	10.6* ↓
10.7* ←	10.7* ↗	10.1 ←	9.9 →	8.1 ←

beste Teiler: 54.1 (6.), 59.9 (7.), 89.5 (3.)
 Trefferlage: 0.55 mm links, 0.29 mm tief
 Streuwert: 2.04, horizontal: 2.83, vertikal: 0.57

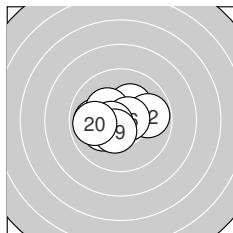

Serie 2: 102.6 (97)

10.2* ↗	9.8 →	9.9 ←	10.7* ↙	10.3* ↖
10.7* →	10.2* ↙	10.5* ←	10.4* ↙	9.9 ←

beste Teiler: 66.6 (14.), 74.3 (16.), 101.1 (18.)
 Trefferlage: 0.57 mm links, 0.01 mm tief
 Streuwert: 1.33, horizontal: 1.69, vertikal: 0.82



Ergebnis: **184.0** (175)
 Serien: 89.2 94.8
 Zähler: 7 6 2 5 0 0 0 0 0 0 0
 Innenzehner: 4
 Weitestе: 859 (2.), 841 (17.), 805 (10.)
 beste Teiler: 101.0 (19.), 116.8 (15.), 184.9 (9.)
 Trefferlage: 0.53 mm links, 1.98 mm hoch
 Streuwert: 3.35, horizontal: 4.29, vertikal: 1.99

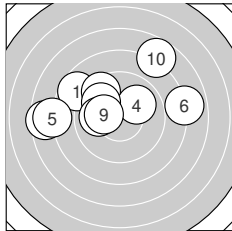
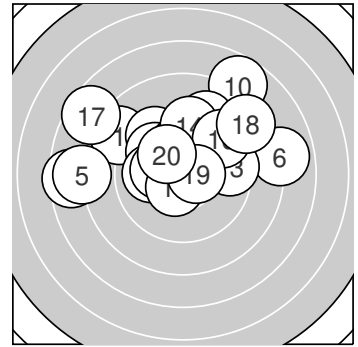

Serie 1: 89.2 (84)

8.7 ↘ 7.5 ← 9.5 ↘ 10.0 ↗ 7.8 ←
 7.9 → 9.9 ↘ 10.0 ← 10.2* ← 7.7 ↗

beste Teiler: 184.9 (9.), 243.0 (8.), 244.4 (4.)
 Trefferlage: 1.61 mm links, 1.73 mm hoch
 Streuwert: 3.87, horizontal: 5.04, vertikal: 2.15

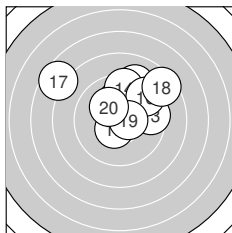

Serie 2: 94.8 (91)

9.2 ↗ 10.1 ↑ 9.5 → 9.4 ↑ 10.5* ↘
 9.3 ↗ 7.6 ↘ 8.5 ↗ 10.5* → 10.2* ↘

beste Teiler: 101.0 (19.), 116.8 (15.), 197.7 (20.)
 Trefferlage: 0.54 mm rechts, 2.23 mm hoch
 Streuwert: 2.70, horizontal: 3.31, vertikal: 1.91



Ergebnis: **182.8** (175)
 Serien: 96.2 86.6
 Zähler: 7 4 6 3 0 0 0 0 0 0 0
 Innenzehner: 6
 Weitestе: 993 (19.), 976 (9.), 855 (15.)
 beste Teiler: 50.0 (10.), 143.5 (4.), 145.5 (3.)
 Trefferlage: 3.63 mm links, 0.49 mm hoch
 Streuwert: 2.84, horizontal: 3.79, vertikal: 1.33

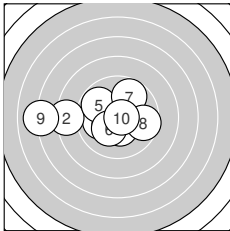
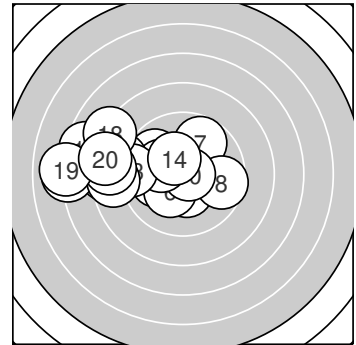

Serie 1: 96.2 (92)

10.0 ←	8.3 ←	10.4* ↓	10.4* ↙	9.8 ↘
10.2* ↘	9.7 ↗	9.6 →	7.0 ←	10.8* →

beste Teiler: 50.0 (10.), 143.5 (4.), 145.5 (3.)
 Trefferlage: 1.74 mm links, 0.10 mm tief
 Streuwert: 2.88, horizontal: 3.85, vertikal: 1.30

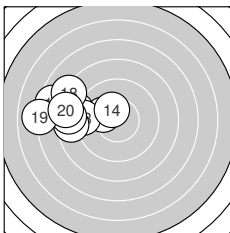

Serie 2: 86.6 (83)

10.2* ↖	8.8 ←	9.2 ←	10.4* ↖	7.5 ←
8.6 ←	8.5 ←	8.1 ↖	7.0 ←	8.3 ←

beste Teiler: 150.8 (14.), 197.2 (11.), 440.1 (13.)
 Trefferlage: 5.53 mm links, 1.09 mm hoch
 Streuwert: 2.09, horizontal: 2.73, vertikal: 1.12



Ergebnis: **192.2** (184)
 Serien: 98.8 93.4
 Zähler: 8 8 4 0 0 0 0 0 0 0
 Innenzehner: 3
 Weitesten: 689 (16.), 670 (11.), 600 (14.)
 beste Teiler: 122.8 (8.), 130.2 (20.), 134.9 (17.)
 Trefferlage: 1.68 mm rechts, 0.51 mm hoch
 Streuwert: 2.42, horizontal: 3.06, vertikal: 1.53

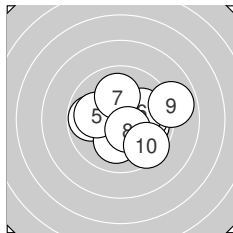
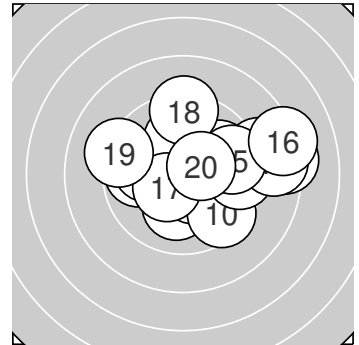

Serie 1: 98.8 (95)

9.9 → 10.0 → 9.8 ←
 10.1 → 10.0 ↑ 10.5* ↘
 beste Teiler: 122.8 (8.), 212.3 (4.), 221.3 (6.)
 Trefferlage: 0.92 mm rechts, 0.10 mm tief
 Streuwert: 2.03, horizontal: 2.44, vertikal: 1.50

10.1 ↓ 10.0 ←
 8.9 → 9.5 ↘

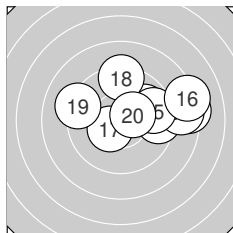

Serie 2: 93.4 (89)

8.3 → 9.9 ↗ 9.5 →
 8.2 → 10.4* ↖ 9.3 ↑
 beste Teiler: 130.2 (20.), 134.9 (17.), 267.2 (12.)
 Trefferlage: 2.44 mm rechts, 1.13 mm hoch
 Streuwert: 2.68, horizontal: 3.54, vertikal: 1.35

8.6 → 9.6 →
 9.2 ← 10.4* →

