

Ergebnis: **202.4** (194)  
 Serien: 102.8 99.6  
 Zähler: 15 4 1 0 0 0 0 0 0 0  
 Innenzehner: 11  
 Weitesten: 557 (15.), 381 (8.), 362 (17.)  
 beste Teiler: 36.2 (7.), 65.0 (12.), 96.8 (9.)  
 Trefferlage: 0.38 mm links, 0.41 mm tief  
 Streuwert: 1.71, horizontal: 2.14, vertikal: 1.13

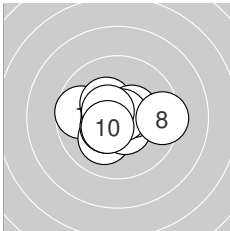
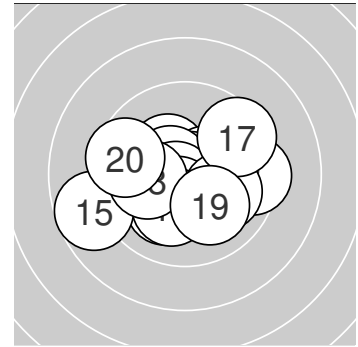

**Serie 1: 102.8 (98)**

9.7 ←	10.1 ↙	10.5* ↘	10.5* ↙	10.3* ↖
10.4* →	10.8* ↗	9.4 →	10.6* ↖	10.5* ↙

beste Teiler: 36.2 (7.), 96.8 (9.), 112.3 (3.)  
 Trefferlage: 0.19 mm links, 0.16 mm tief  
 Streuwert: 1.44, horizontal: 1.84, vertikal: 0.89

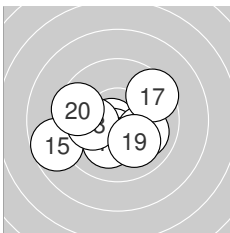

**Serie 2: 99.6 (96)**

10.5* ↓	10.7* ↙	10.4* ↓	10.2* ↙	8.7 ←
10.0 →	9.5 ↗	10.1 ←	10.0 ↘	9.5 ←

beste Teiler: 65.0 (12.), 108.0 (11.), 130.2 (13.)  
 Trefferlage: 0.58 mm links, 0.66 mm tief  
 Streuwert: 1.99, horizontal: 2.49, vertikal: 1.32



Ergebnis: **196.0** (187)  
 Serien: 98.7 97.3  
 Zähler: 12 4 3 1 0 0 0 0 0 0 0  
 Innenzehner: 10  
 Weitesten: 890 (19.), 630 (5.), 549 (18.)  
 beste Teiler: 51.8 (2.), 64.0 (15.), 101.1 (3.)  
 Trefferlage: 0.68 mm links, 0.15 mm hoch  
 Streuwert: 2.53, horizontal: 3.14, vertikal: 1.70

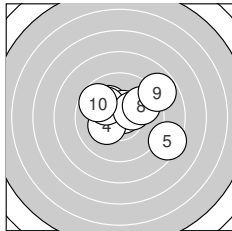
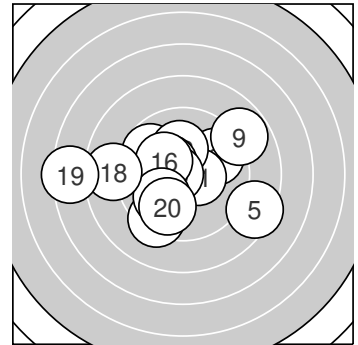

**Serie 1: 98.7 (94)**

10.2\* ↘ 10.7\* ↗ 10.5\* ↗ 10.2\* ↖ 8.4 ↘  
 10.1 ↘ 10.3\* ↗ 9.8 ↗ 8.8 ↗ 9.7 ↘  
 beste Teiler: 51.8 (2.), 101.1 (3.), 165.9 (7.)  
 Trefferlage: 0.80 mm rechts, 0.71 mm hoch  
 Streuwert: 2.24, horizontal: 2.74, vertikal: 1.59

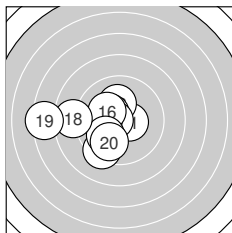

**Serie 2: 97.3 (93)**

10.5\* → 10.2\* ↑ 9.3 ↘ 10.4\* ↘ 10.7\* ←  
 10.2\* ↘ 10.0 ↘ 8.8 ← 7.4 ← 9.8 ↘  
 beste Teiler: 64.0 (15.), 118.0 (11.), 140.0 (14.)  
 Trefferlage: 2.17 mm links, 0.40 mm tief  
 Streuwert: 2.38, horizontal: 2.91, vertikal: 1.70



**ÖSB LG 20 ZR**

StandNr: 135

**Woertz,, Theresa** #70218033

**Jugend\_II\_weibl.**

Wertung

**StartNr: 172**

02.03.2024 14:58

SG\_Matrei\_a.\_B.

Ergebnis: **0.0** (0)<sub>DNS</sub>  
Serien:  
Zähler: 0 0 0 0 0 0 0 0 0 0 0  
Innenzehner: 0  
Weiteste:  
~~beste Teiler~~Schütze ist nicht zum Wettkampf angetreten  
Trefferlage: 0.00 mm , 0.00 mm  
Streuwert:

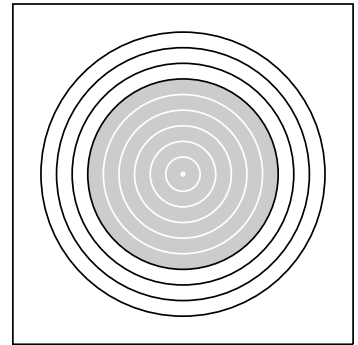

Ergebnis: **185.4** (173)  
 Serien: 95.4 90.0  
 Zähler: 5 8 4 1 2 0 0 0 0 0 0  
 Innenzehner: 5  
 Weitester: 1031 (7.), 1028 (11.), 804 (15.)  
 beste Teiler: 49.3 (9.), 75.2 (10.), 88.5 (13.)  
 Trefferlage: 0.68 mm rechts, 0.41 mm hoch  
 Streuwert: 3.64, horizontal: 4.58, vertikal: 2.33

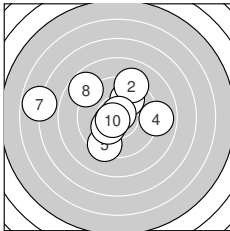
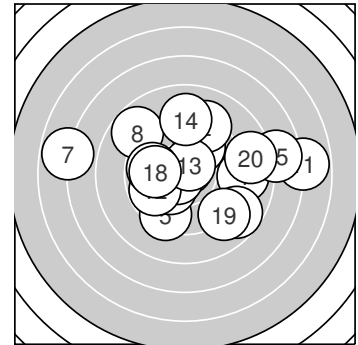

**Serie 1: 95.4 (89)**

9.9 ↗	9.2 ↗	10.6* ↙	8.9 →	9.4 ↘
10.3* ↙	6.8 ←	8.8 ↘	10.8* ↗	10.7* ↙

beste Teiler: 49.3 (9.), 75.2 (10.), 99.8 (3.)  
 Trefferlage: 1.04 mm links, 0.64 mm hoch  
 Streuwert: 3.28, horizontal: 4.01, vertikal: 2.33

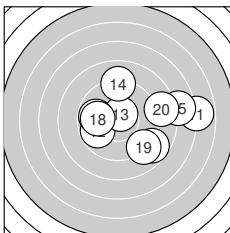

**Serie 2: 90.0 (84)**

6.8 →	9.8 ↙	10.6* ↗	9.1 ↑	7.7 →
8.7 ↘	9.8 ←	9.9 ←	9.0 ↘	8.6 →

beste Teiler: 88.5 (13.), 259.8 (18.), 286.2 (17.)  
 Trefferlage: 2.41 mm rechts, 0.19 mm hoch  
 Streuwert: 3.71, horizontal: 4.65, vertikal: 2.43



Ergebnis: **192.7** (185)  
 Serien: 95.8 96.9  
 Zähler: 9 7 4 0 0 0 0 0 0 0  
 Innenzehner: 3  
 Weitester: 658 (12.), 521 (7.), 514 (14.)  
 beste Teiler: 100.8 (16.), 123.9 (20.), 178.1 (18.)  
 Trefferlage: 0.32 mm rechts, 0.78 mm hoch  
 Streuwert: 2.55, horizontal: 3.04, vertikal: 1.92

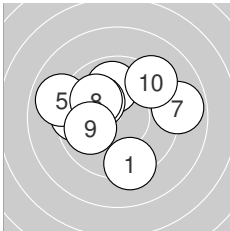
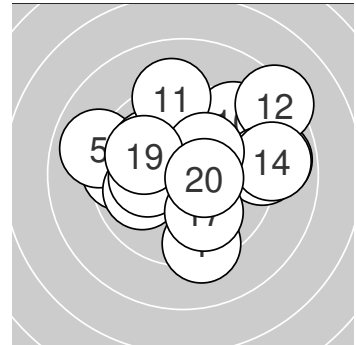

**Serie 1: 95.8 (91)**

9.3 ↓                      10.0 ←                      9.5 ←  
 10.1 ↘                      8.9 →                      10.0 ↘  
 beste Teiler: 207.7 (6.), 235.6 (8.), 244.0 (2.)  
 Trefferlage: 0.79 mm links, 0.59 mm hoch  
 Streuwert: 2.57, horizontal: 3.04, vertikal: 1.99

9.9 ↑                      8.9 ↖  
 9.9 ←                      9.3 ↗

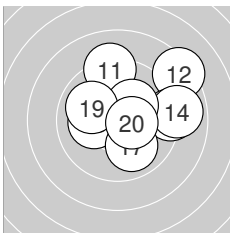

**Serie 2: 96.9 (94)**

9.2 ↑                      8.3 ↗                      9.1 →  
 10.6\* ↗                      10.0 ↓                      10.2\* ↗  
 beste Teiler: 100.8 (16.), 123.9 (20.), 178.1 (18.)  
 Trefferlage: 1.45 mm rechts, 0.98 mm hoch  
 Streuwert: 2.37, horizontal: 2.74, vertikal: 1.94

8.9 →                      10.1 ←  
 10.0 ↘                      10.5\* →



Ergebnis: **173.2** (165)  
 Serien: 87.2 86.0  
 Zähler: 2 7 7 2 2 0 0 0 0 0 0  
 Innenzehner: 2  
 Weitester: 1070 (15.), 1010 (7.), 916 (1.)  
 beste Teiler: 159.6 (5.), 195.2 (9.), 274.4 (12.)  
 Trefferlage: 2.85 mm rechts, 1.61 mm tief  
 Streuwert: 3.87, horizontal: 4.34, vertikal: 3.34

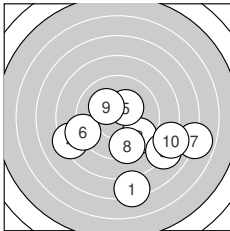
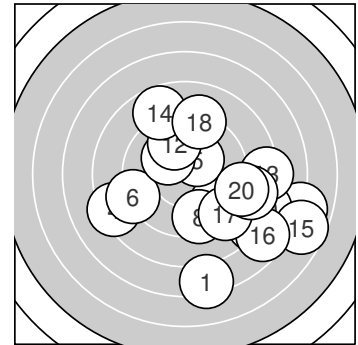

**Serie 1: 87.2 (84)**

7.3 ↓                      9.5 ↘                      8.1 ↘                      8.3 ←                      10.3\* ↗  
 9.1 ←                      6.9 →                      9.5 ↓                      10.2\* ↖                      8.0 →  
 beste Teiler: 159.6 (5.), 195.2 (9.), 354.5 (2.)  
 Trefferlage: 1.71 mm rechts, 2.71 mm tief  
 Streuwert: 3.99, horizontal: 4.85, vertikal: 2.89

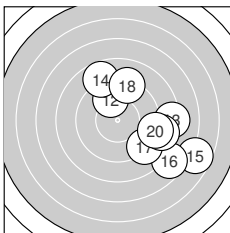

**Serie 2: 86.0 (81)**

8.9 →                      9.9 ↑                      8.2 →                      8.7 ↑                      6.7 →  
 7.7 →                      9.1 ↘                      9.1 ↑                      8.7 →                      9.0 →  
 beste Teiler: 274.4 (12.), 452.9 (18.), 472.3 (17.)  
 Trefferlage: 3.98 mm rechts, 0.52 mm tief  
 Streuwert: 3.60, horizontal: 3.66, vertikal: 3.54



Ergebnis: **198.9** (190)  
 Serien: 102.4 96.5  
 Zähler: 11 8 1 0 0 0 0 0 0 0  
 Innenzehner: 9  
 Weitester: 526 (17.), 469 (16.), 467 (13.)  
 beste Teiler: 48.0 (18.), 50.0 (11.), 85.2 (2.)  
 Trefferlage: 0.19 mm rechts, 0.34 mm hoch  
 Streuwert: 2.12, horizontal: 2.02, vertikal: 2.22

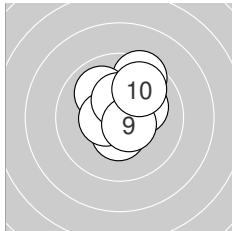
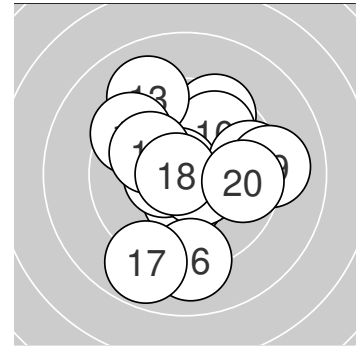

**Serie 1: 102.4 (98)**

9.5 ↗	10.6* ↓	10.4* ↘	10.4* ↓	10.0 ↘
10.2* ↗	10.5* ←	10.4* ↑	10.6* ↘	9.8 ↗

beste Teiler: 85.2 (2.), 96.4 (9.), 112.6 (7.)  
 Trefferlage: 0.21 mm rechts, 0.77 mm hoch  
 Streuwert: 1.34, horizontal: 1.19, vertikal: 1.48

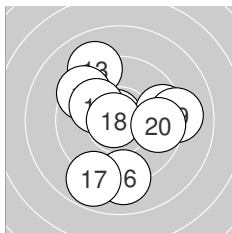

**Serie 2: 96.5 (92)**

10.8* ↘	9.5 →	9.1 ↘	9.5 ↘	10.1 ↘
9.1 ↓	8.8 ↙	10.8* ←	9.1 →	9.7 →

beste Teiler: 48.0 (18.), 50.0 (11.), 223.1 (15.)  
 Trefferlage: 0.17 mm rechts, 0.08 mm tief  
 Streuwert: 2.74, horizontal: 2.69, vertikal: 2.79



Ergebnis: **188.1** (179)  
 Serien: 91.4 96.7  
 Zähler: 8 5 6 0 1 0 0 0 0 0 0  
 Innenzehner: 4  
 Weitestе: 1053 (2.), 719 (4.), 574 (11.)  
 beste Teiler: 82.7 (20.), 128.2 (6.), 157.0 (12.)  
 Trefferlage: 1.41 mm links, 0.65 mm hoch  
 Streuwert: 3.07, horizontal: 3.17, vertikal: 2.96

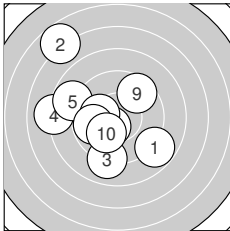
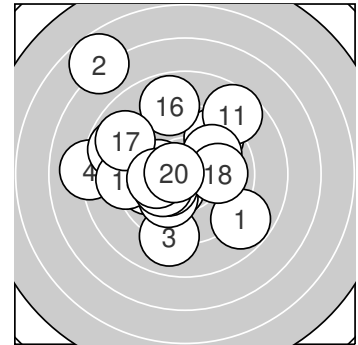

**Serie 1: 91.4 (87)**

8.8 ↘      6.7 ↖      9.0 ↓  
 10.4\* ↙      10.1 ←      9.8 ←  
 beste Teiler: 128.2 (6.), 204.0 (7.), 217.0 (10.)  
 Trefferlage: 2.03 mm links, 0.19 mm hoch  
 Streuwert: 3.60, horizontal: 3.58, vertikal: 3.62

8.1 ←      8.8 ↖  
 9.6 ↗      10.1 ↙

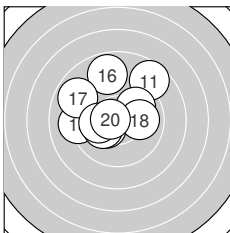

**Serie 2: 96.7 (92)**

8.7 ↗      10.3\* ↙      9.2 ←  
 8.8 ↑      8.9 ↖      10.0 →  
 beste Teiler: 82.7 (20.), 157.0 (12.), 190.7 (14.)  
 Trefferlage: 0.79 mm links, 1.12 mm hoch  
 Streuwert: 2.50, horizontal: 2.75, vertikal: 2.23

10.2\* ↖      9.9 ↗  
 10.1 ←      10.6\* ←





Ergebnis: **203.4** (194)  
 Serien: 100.1 103.3  
 Zähler: 15 4 1 0 0 0 0 0 0 0  
 Innenzehner: 12  
 Weitestе: 519 (10.), 356 (1.), 293 (4.)  
 beste Teiler: 38.8 (18.), 78.2 (17.), 100.7 (6.)  
 Trefferlage: 0.21 mm rechts, 0.26 mm hoch  
 Streuwert: 1.61, horizontal: 1.85, vertikal: 1.31

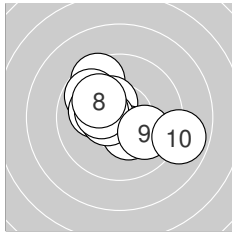
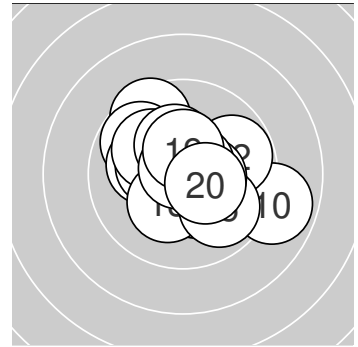

**Serie 1: 100.1 (96)**

9.5 ↖	10.4* ↖	10.4* ↘	9.8 ↖	10.1 ←
10.6* ←	10.3* ←	10.1 ↖	10.0 ↘	8.9 ↘

beste Teiler: 100.7 (6.), 140.1 (2.), 150.0 (3.)  
 Trefferlage: 0.33 mm links, 0.40 mm hoch  
 Streuwert: 1.95, horizontal: 2.30, vertikal: 1.51

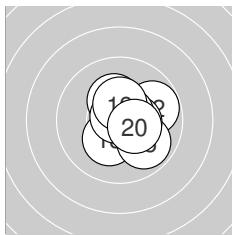

**Serie 2: 103.3 (98)**

10.4* →	9.8 →	10.3* ↙	10.3* ↖	9.9 ↘
10.4* →	10.6* ↗	10.8* ↖	10.4* ↑	10.4* ↘

beste Teiler: 38.8 (18.), 78.2 (17.), 128.0 (11.)  
 Trefferlage: 0.75 mm rechts, 0.11 mm hoch  
 Streuwert: 1.14, horizontal: 1.14, vertikal: 1.14



Ergebnis: **190.2** (182)  
 Serien: 91.2 99.0  
 Zähler: 7 8 5 0 0 0 0 0 0 0  
 Innenzehner: 6  
 Weitester: 748 (2.), 680 (9.), 638 (4.)  
 beste Teiler: 77.1 (20.), 115.6 (15.), 116.7 (7.)  
 Trefferlage: 0.35 mm links, 0.53 mm tief  
 Streuwert: 2.99, horizontal: 3.55, vertikal: 2.29

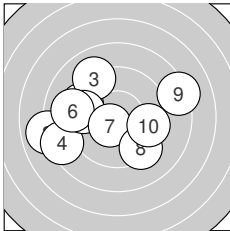
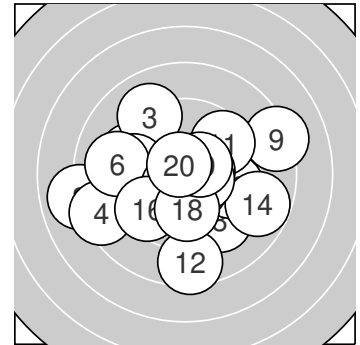

**Serie 1: 91.2 (88)**

9.4 ↖	8.0 ←	9.1 ↘	8.4 ↖	9.5 ←
9.1 ←	10.5* ↙	9.4 ↘	8.2 →	9.6 →

beste Teiler: 116.7 (7.), 332.5 (10.), 358.2 (5.)  
 Trefferlage: 1.63 mm links, 0.00 mm  
 Streuwert: 3.48, horizontal: 4.37, vertikal: 2.26

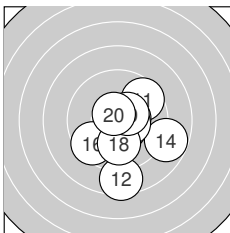

**Serie 2: 99.0 (94)**

9.6 ↗	8.5 ↓	10.5* →	8.8 →	10.5* ↘
9.5 ↙	10.5* →	10.0 ↓	10.5* ↗	10.6* ↖

beste Teiler: 77.1 (20.), 115.6 (15.), 122.3 (19.)  
 Trefferlage: 0.93 mm rechts, 1.05 mm tief  
 Streuwert: 2.16, horizontal: 1.98, vertikal: 2.32



Ergebnis: **193.3** (184)  
 Serien: 96.9 96.4  
 Zähler: 9 7 3 1 0 0 0 0 0 0 0  
 Innenzehner: 6  
 Weitestе: 917 (4.), 719 (20.), 565 (10.)  
 beste Teiler: 27.4 (3.), 68.0 (16.), 110.5 (6.)  
 Trefferlage: 0.85 mm links, 0.40 mm hoch  
 Streuwert: 2.73, horizontal: 2.84, vertikal: 2.61

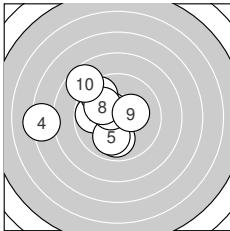
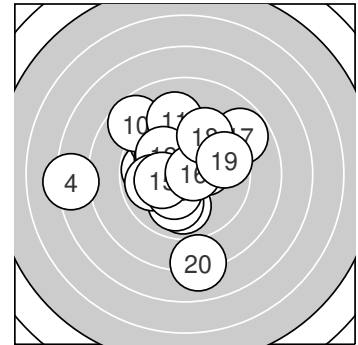

**Serie 1: 96.9 (92)**

9.9 ↓                    9.8 ←                    10.8\* ↘                    7.3 ←                    10.0 ↓  
 10.5\* ↘                    9.6 ↘                    10.0 ↘                    10.3\* →                    8.7 ↘  
 beste Teiler: 27.4 (3.), 110.5 (6.), 168.2 (9.)  
 Trefferlage: 2.02 mm links, 0.44 mm hoch  
 Streuwert: 2.53, horizontal: 2.95, vertikal: 2.02

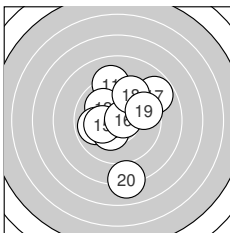

**Serie 2: 96.4 (92)**

9.2 ↑                    10.0 ↘                    9.9 ←                    10.3\* ↙                    10.2\* ←  
 10.7\* →                    8.8 ↗                    9.6 ↗                    9.6 →                    8.1 ↓  
 beste Teiler: 68.0 (16.), 161.7 (14.), 189.7 (15.)  
 Trefferlage: 0.30 mm rechts, 0.36 mm hoch  
 Streuwert: 2.79, horizontal: 2.29, vertikal: 3.22



Ergebnis: **201.6** (193)  
 Serien: 101.2 100.4  
 Zähler: 14 5 1 0 0 0 0 0 0 0  
 Innenzehner: 10  
 Weitester: 629 (15.), 491 (2.), 325 (11.)  
 beste Teiler: 53.0 (6.), 74.9 (17.), 83.6 (14.)  
 Trefferlage: 0.02 mm links, 0.70 mm hoch  
 Streuwert: 1.81, horizontal: 2.23, vertikal: 1.25

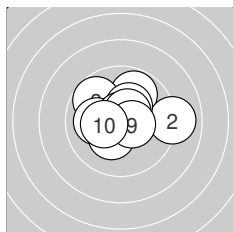
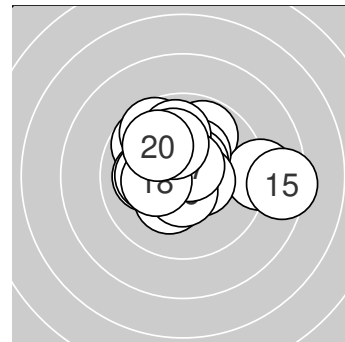

**Serie 1: 101.2 (97)**

9.8 ↗	9.0 →	9.7 ↘	10.1 ←	10.3* ↗
10.7* ↑	10.5* ↗	10.3* ↘	10.5* →	10.3* ←

beste Teiler: 53.0 (6.), 105.4 (7.), 110.8 (9.)  
 Trefferlage: 0.16 mm rechts, 0.53 mm hoch  
 Streuwert: 1.73, horizontal: 2.14, vertikal: 1.18

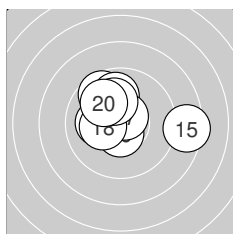

**Serie 2: 100.4 (96)**

9.7 ↘	10.1 ←	9.9 ↑	10.6* ↘	8.4 →
10.6* ↓	10.7* ↗	10.3* ←	10.1 ↑	10.0 ↘

beste Teiler: 74.9 (17.), 83.6 (14.), 96.0 (16.)  
 Trefferlage: 0.22 mm links, 0.88 mm hoch  
 Streuwert: 1.96, horizontal: 2.42, vertikal: 1.35



Ergebnis: **185.0** (174)  
 Serien: 89.2 95.8  
 Zähler: 5 8 4 2 1 0 0 0 0 0 0  
 Innenzehner: 4  
 Weitesten: 1021 (9.), 865 (10.), 792 (11.)  
 beste Teiler: 59.4 (17.), 88.4 (2.), 133.3 (8.)  
 Trefferlage: 0.62 mm rechts, 0.28 mm hoch  
 Streuwert: 3.61, horizontal: 4.21, vertikal: 2.87

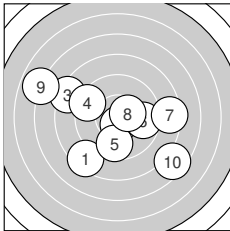
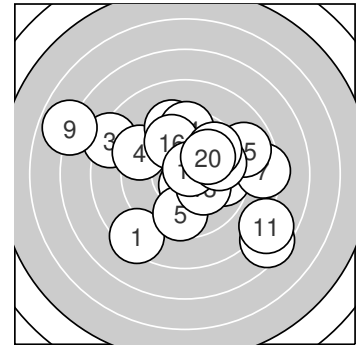

**Serie 1: 89.2 (84)**

8.4 ↙ 10.6\* ↓ 8.3 ↖ 9.3 ↖ 9.7 ↓  
 9.7 → 8.4 → 10.4\* → 6.9 ↖ 7.5 ↘

beste Teiler: 88.4 (2.), 133.3 (8.), 317.2 (6.)  
 Trefferlage: 0.60 mm links, 0.58 mm tief  
 Streuwert: 4.35, horizontal: 5.29, vertikal: 3.14

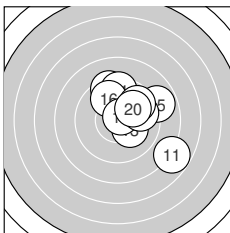

**Serie 2: 95.8 (90)**

7.8 ↘ 9.4 ↑ 10.2\* ↘ 9.5 ↑ 8.9 →  
 9.8 ↖ 10.7\* ↗ 9.8 → 9.7 ↗ 10.0 ↗

beste Teiler: 59.4 (17.), 187.6 (13.), 236.4 (20.)  
 Trefferlage: 1.85 mm rechts, 1.16 mm hoch  
 Streuwert: 2.45, horizontal: 2.49, vertikal: 2.41



Ergebnis: **177.0** (165)  
 Serien: 87.7 89.3  
 Zähler: 0 10 6 3 1 0 0 0 0 0 0  
 Innenzehner: 0  
 Weitester: 1024 (2.), 785 (7.), 779 (6.)  
 beste Teiler: 261.0 (16.), 271.0 (9.), 299.1 (8.)  
 Trefferlage: 1.76 mm rechts, 2.61 mm hoch  
 Streuwert: 3.36, horizontal: 4.33, vertikal: 1.97

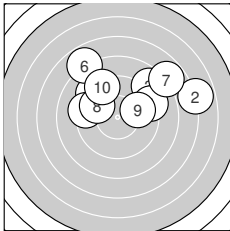
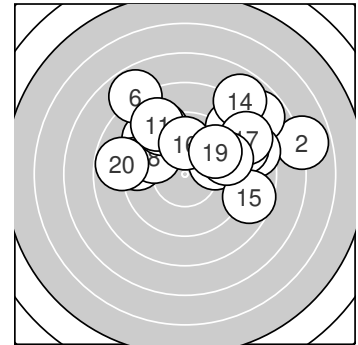

**Serie 1: 87.7 (82)**

9.2 ↘	6.9 →	8.7 ↗	9.1 →	9.3 ←
7.8 ↘	7.8 ↗	9.8 ↘	9.9 →	9.2 ↘

beste Teiler: 271.0 (9.), 299.1 (8.), 414.4 (5.)  
 Trefferlage: 1.09 mm rechts, 2.99 mm hoch  
 Streuwert: 3.72, horizontal: 4.92, vertikal: 1.85

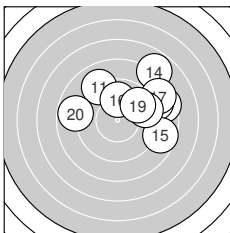

**Serie 2: 89.3 (83)**

9.0 ↘	8.5 →	8.8 →	7.9 ↗	8.7 →
9.9 ↑	8.6 ↗	9.4 →	9.7 ↗	8.8 ←

beste Teiler: 261.0 (16.), 320.2 (19.), 377.4 (18.)  
 Trefferlage: 2.44 mm rechts, 2.23 mm hoch  
 Streuwert: 3.07, horizontal: 3.78, vertikal: 2.12



Ergebnis: **197.7** (188)  
 Serien: 96.4 101.3  
 Zähler: 10 8 2 0 0 0 0 0 0 0  
 Innenzehner: 8  
 Weitester: 633 (10.), 502 (2.), 400 (16.)  
 beste Teiler: 92.5 (13.), 106.7 (3.), 123.1 (14.)  
 Trefferlage: 0.84 mm rechts, 0.72 mm hoch  
 Streuwert: 2.03, horizontal: 2.44, vertikal: 1.52

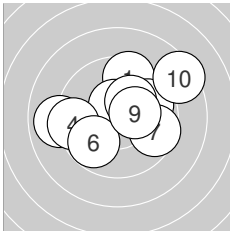
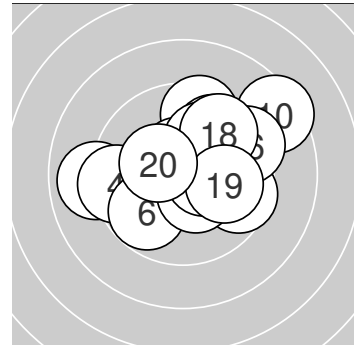

**Serie 1: 96.4 (91)**

9.5 ↑	8.9 ←	10.5* ↑	9.4 ←	9.8 →
9.8 ↙	9.6 ↘	10.2* ↗	10.3* →	8.4 ↗

beste Teiler: 106.7 (3.), 154.9 (9.), 178.3 (8.)  
 Trefferlage: 0.35 mm rechts, 0.65 mm hoch  
 Streuwert: 2.61, horizontal: 3.21, vertikal: 1.83

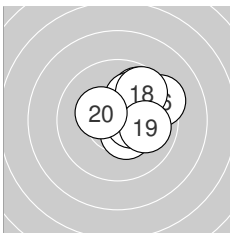

**Serie 2: 101.3 (97)**

10.5* →	10.4* ↘	10.6* ↗	10.5* →	9.8 ↗
9.4 →	10.1 ↗	9.7 ↗	10.0 →	10.3* ↖

beste Teiler: 92.5 (13.), 123.1 (14.), 125.2 (11.)  
 Trefferlage: 1.34 mm rechts, 0.79 mm hoch  
 Streuwert: 1.27, horizontal: 1.31, vertikal: 1.24



Ergebnis: **192.1** (183)  
 Serien: 96.3 95.8  
 Zähler: 6 11 3 0 0 0 0 0 0 0  
 Innenzehner: 4  
 Weitestе: 579 (15.), 548 (9.), 534 (4.)  
 beste Teiler: 107.9 (6.), 154.7 (17.), 174.8 (1.)  
 Trefferlage: 0.46 mm links, 1.22 mm hoch  
 Streuwert: 2.46, horizontal: 2.77, vertikal: 2.10

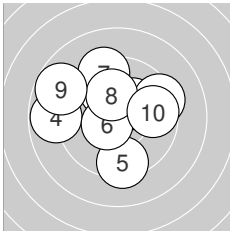
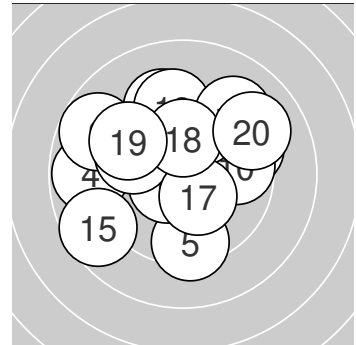

**Serie 1: 96.3 (91)**

10.3\* ↗ 9.9 ↖ 9.4 →  
 10.5\* ↙ 9.3 ↑ 10.2\* ↑

8.8 ← 9.4 ↓  
 8.8 ↖ 9.7 →

beste Teiler: 107.9 (6.), 174.8 (1.), 200.5 (8.)  
 Trefferlage: 0.55 mm links, 0.92 mm hoch  
 Streuwert: 2.56, horizontal: 2.93, vertikal: 2.13

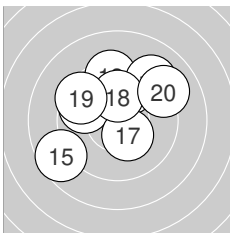

**Serie 2: 95.8 (92)**

10.1 ↖ 9.8 ↑ 9.4 ↑  
 9.2 ↗ 10.3\* ↘ 10.1 ↑

9.7 ↖ 8.6 ↙  
 9.5 ↖ 9.1 ↗

beste Teiler: 154.7 (17.), 209.0 (18.), 220.9 (11.)  
 Trefferlage: 0.37 mm links, 1.52 mm hoch  
 Streuwert: 2.47, horizontal: 2.76, vertikal: 2.14





Ergebnis: **192.4** (187)  
 Serien: 97.4 95.0  
 Zähler: 10 8 1 1 0 0 0 0 0 0  
 Innenzehner: 7  
 Weitesten: 845 (13.), 707 (1.), 489 (8.)  
 beste Teiler: 99.1 (6.), 127.9 (19.), 145.3 (4.)  
 Trefferlage: 0.92 mm links, 0.21 mm hoch  
 Streuwert: 2.71, horizontal: 2.88, vertikal: 2.53

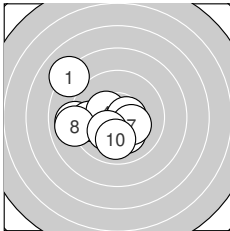
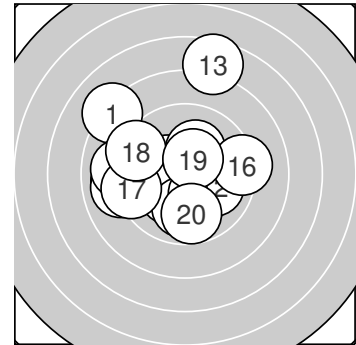

**Serie 1: 97.4 (95)**

8.1 ↖ 9.0 ← 9.7 ← 10.4\* ↖ 10.1 ↘  
 10.6\* → 10.3\* ↘ 9.0 ← 10.2\* ↗ 10.0 ↓  
 beste Teiler: 99.1 (6.), 145.3 (4.), 174.0 (7.)  
 Trefferlage: 1.73 mm links, 0.32 mm tief  
 Streuwert: 2.31, horizontal: 2.62, vertikal: 1.94

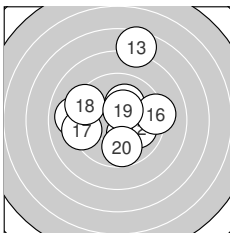

**Serie 2: 95.0 (92)**

10.2\* ↘ 10.0 ↘ 7.6 ↑ 10.2\* ↑ 9.0 ←  
 9.2 → 9.3 ← 9.3 ↖ 10.4\* ↑ 9.8 ↓  
 beste Teiler: 127.9 (19.), 176.7 (11.), 195.2 (14.)  
 Trefferlage: 0.10 mm links, 0.75 mm hoch  
 Streuwert: 3.02, horizontal: 3.02, vertikal: 3.02



Ergebnis: **169.6** (161)  
 Serien: 81.9 87.7  
 Zähler: 3 6 5 4 0 1 1 0 0 0 0  
 Innenzehner: 3  
 Weitester: 1668 (1.), 1259 (2.), 984 (17.)  
 beste Teiler: 68.6 (7.), 153.8 (3.), 191.8 (18.)  
 Trefferlage: 1.46 mm links, 1.10 mm tief  
 Streuwert: 5.09, horizontal: 6.57, vertikal: 2.93

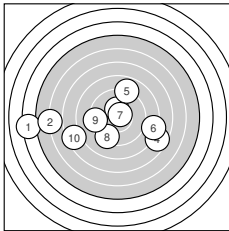
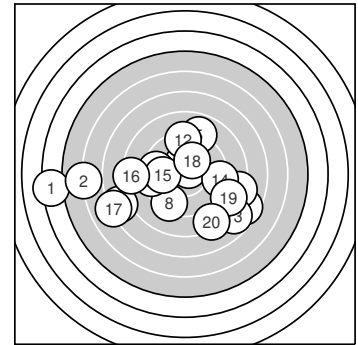

**Serie 1: 81.9 (77)**

4.3 ←	5.9 ←	10.3* ↑	7.6 →	8.9 ↑
8.2 →	10.7* ↗	9.3 ↘	9.3 ←	7.4 ←

beste Teiler: 68.6 (7.), 153.8 (3.), 406.7 (8.)  
 Trefferlage: 2.72 mm links, 0.94 mm tief  
 Streuwert: 5.85, horizontal: 7.81, vertikal: 2.75

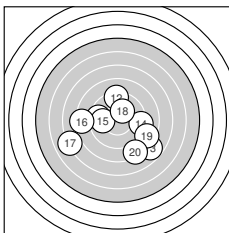

**Serie 2: 87.7 (84)**

9.5 ←	9.2 ↑	7.8 ↘	9.2 →	9.8 ←
8.3 ←	7.0 ↙	10.2* ↗	8.5 →	8.2 ↘

beste Teiler: 191.8 (18.), 276.2 (15.), 361.5 (11.)  
 Trefferlage: 0.20 mm links, 1.26 mm tief  
 Streuwert: 4.31, horizontal: 5.17, vertikal: 3.23



Ergebnis: **195.0** (186)  
 Serien: 96.2 98.8  
 Zähler: 8 10 2 0 0 0 0 0 0 0  
 Innenzehner: 6  
 Weiteste: 596 (5.), 514 (1.), 496 (18.)  
 beste Teiler: 33.1 (16.), 85.0 (11.), 92.2 (9.)  
 Trefferlage: 0.22 mm rechts, 0.94 mm hoch  
 Streuwert: 2.37, horizontal: 2.56, vertikal: 2.17

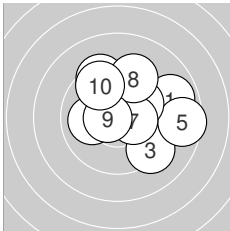
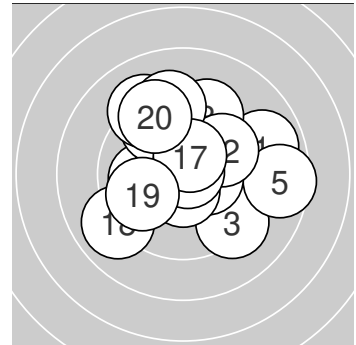

**Serie 1: 96.2 (92)**

8.9 →	9.4 ↖	9.3 ↘	10.0 ←	8.6 →
10.0 ↗	10.4* →	9.4 ↗	10.6* ←	9.6 ↖

beste Teiler: 92.2 (9.), 148.2 (7.), 235.6 (4.)  
 Trefferlage: 1.23 mm rechts, 0.90 mm hoch  
 Streuwert: 2.50, horizontal: 2.85, vertikal: 2.09

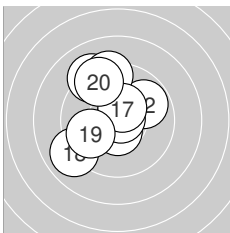

**Serie 2: 98.8 (94)**

10.6* ↗	9.8 ↗	10.5* ↓	9.1 ↖	9.3 ↑
10.8* ↗	10.5* ↗	9.0 ↙	9.8 ↙	9.4 ↖

beste Teiler: 33.1 (16.), 85.0 (11.), 101.0 (13.)  
 Trefferlage: 0.78 mm links, 0.98 mm hoch  
 Streuwert: 2.13, horizontal: 1.87, vertikal: 2.36



Ergebnis: **201.6** (195)  
 Serien: 99.7 101.9  
 Zähler: 16 3 1 0 0 0 0 0 0 0  
 Innenzehner: 10  
 Weitester: 510 (10.), 482 (2.), 324 (12.)  
 beste Teiler: 20.5 (17.), 102.3 (13.), 112.4 (8.)  
 Trefferlage: 0.47 mm links, 0.27 mm tief  
 Streuwert: 1.74, horizontal: 2.09, vertikal: 1.29

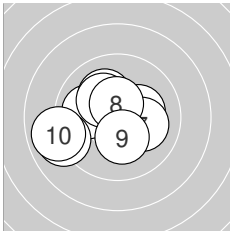
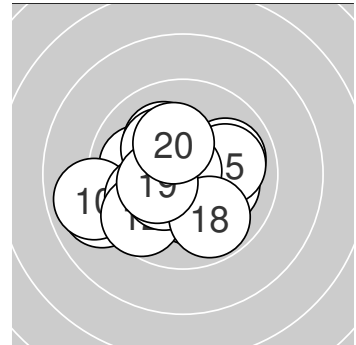

**Serie 1: 99.7 (97)**

10.0 ←	9.0 ←	10.1 ↘	10.2* ↘	10.2* →
10.4* →	10.1 →	10.5* ↑	10.3* ↓	8.9 ←

beste Teiler: 112.4 (8.), 130.9 (6.), 168.1 (9.)  
 Trefferlage: 0.88 mm links, 0.07 mm tief  
 Streuwert: 1.95, horizontal: 2.43, vertikal: 1.30

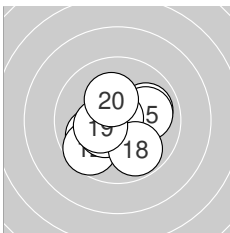

**Serie 2: 101.9 (98)**

10.0 ↙	9.7 ↙	10.5* ↘	10.0 →	10.0 →
10.4* ↙	10.9* ↘	9.8 ↘	10.4* ←	10.2* ↑

beste Teiler: 20.5 (17.), 102.3 (13.), 134.3 (16.)  
 Trefferlage: 0.06 mm links, 0.47 mm tief  
 Streuwert: 1.53, horizontal: 1.71, vertikal: 1.32



Ergebnis: **199.5** (191)  
 Serien: 99.3 100.2  
 Zähler: 13 5 2 0 0 0 0 0 0 0  
 Innenzehner: 10  
 Weitester: 543 (13.), 507 (10.), 492 (1.)  
 beste Teiler: 72.2 (19.), 79.7 (6.), 82.3 (15.)  
 Trefferlage: 0.47 mm links, 0.48 mm hoch  
 Streuwert: 1.98, horizontal: 2.36, vertikal: 1.52

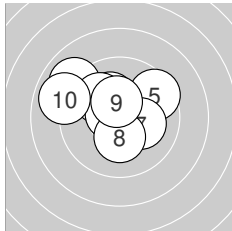
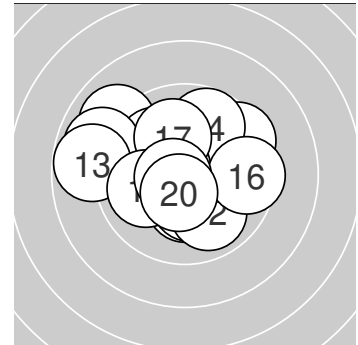

**Serie 1: 99.3 (96)**

9.0 ↘	10.2* ↖	10.2* →	10.0 ↘	9.5 ↗
10.6* ↖	10.2* →	10.3* ↓	10.4* ↑	8.9 ↖

beste Teiler: 79.7 (6.), 138.4 (9.), 171.0 (8.)  
 Trefferlage: 0.57 mm links, 0.98 mm hoch  
 Streuwert: 1.99, horizontal: 2.47, vertikal: 1.36

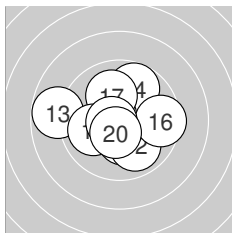

**Serie 2: 100.2 (95)**

10.3* ↓	9.9 ↘	8.8 ←	9.8 ↗	10.6* ↖
9.5 →	10.1 ↑	10.0 ←	10.7* ←	10.5* ↓

beste Teiler: 72.2 (19.), 82.3 (15.), 113.5 (20.)  
 Trefferlage: 0.37 mm links, 0.01 mm tief  
 Streuwert: 2.01, horizontal: 2.38, vertikal: 1.57



Ergebnis: **178.0** (168)  
 Serien: 92.0 86.0  
 Zähler: 3 7 6 3 1 0 0 0 0 0 0  
 Innenzehner: 1  
 Weitester: 1066 (8.), 884 (20.), 768 (13.)  
 beste Teiler: 63.9 (7.), 234.0 (1.), 245.2 (15.)  
 Trefferlage: 1.04 mm rechts, 0.39 mm tief  
 Streuwert: 3.99, horizontal: 4.14, vertikal: 3.85

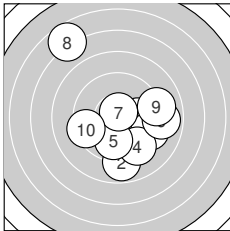
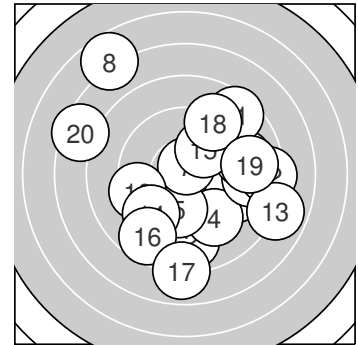

**Serie 1: 92.0 (87)**

10.0 →	8.8 ↓	9.3 ↘	9.3 ↘	9.8 ↓
8.9 →	10.7* ↑	6.7 ↙	9.1 →	9.4 ←

beste Teiler: 63.9 (7.), 234.0 (1.), 278.1 (5.)  
 Trefferlage: 0.86 mm rechts, 0.39 mm tief  
 Streuwert: 3.69, horizontal: 3.57, vertikal: 3.80

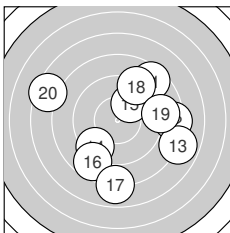

**Serie 2: 86.0 (81)**

8.5 ↗	8.3 →	7.9 ↘	9.3 ↙	10.0 ↗
8.7 ↙	7.9 ↓	9.1 ↗	8.9 →	7.4 ↖

beste Teiler: 245.2 (15.), 409.2 (14.), 462.6 (18.)  
 Trefferlage: 1.22 mm rechts, 0.38 mm tief  
 Streuwert: 4.48, horizontal: 4.83, vertikal: 4.10



Ergebnis: **189.7** (181)  
 Serien: 94.7 95.0  
 Zähler: 8 7 3 2 0 0 0 0 0 0 0  
 Innenzehner: 6  
 Weitesten: 924 (3.), 826 (14.), 734 (15.)  
 beste Teiler: 11.4 (9.), 48.7 (19.), 51.6 (6.)  
 Trefferlage: 2.38 mm rechts, 0.50 mm hoch  
 Streuwert: 2.72, horizontal: 2.86, vertikal: 2.58

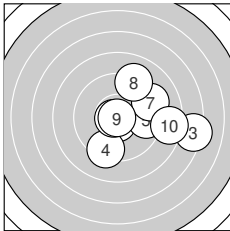
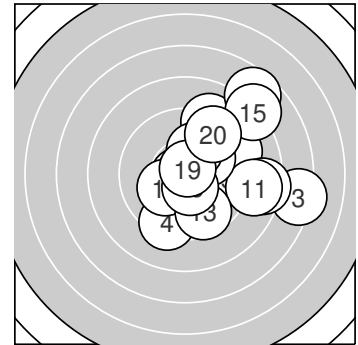

**Serie 1: 94.7 (90)**

9.5 → 10.7\* ↓ 7.3 → 9.3 ↓ 9.6 →  
 10.7\* ← 9.2 ↗ 9.1 ↗ 10.9\* ↖ 8.4 →  
 beste Teiler: 11.4 (9.), 51.6 (6.), 69.0 (2.)  
 Trefferlage: 2.61 mm rechts, 0.16 mm tief  
 Streuwert: 2.77, horizontal: 3.31, vertikal: 2.10

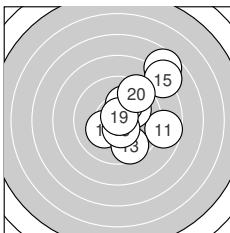

**Serie 2: 95.0 (91)**

8.7 → 10.2\* ↖ 9.6 ↓ 7.6 ↗ 8.0 ↗  
 10.1 ↗ 10.1 ↗ 10.5\* ↓ 10.8\* ↗ 9.4 ↗  
 beste Teiler: 48.7 (19.), 111.7 (18.), 189.9 (12.)  
 Trefferlage: 2.16 mm rechts, 1.18 mm hoch  
 Streuwert: 2.72, horizontal: 2.49, vertikal: 2.93



Ergebnis: **191.5** (182)  
 Serien: 96.9 94.6  
 Zähler: 9 4 7 0 0 0 0 0 0 0 0  
 Innenzehner: 5  
 Weitestе: 647 (19.), 629 (7.), 627 (17.)  
 beste Teiler: 75.1 (4.), 113.2 (14.), 124.2 (18.)  
 Trefferlage: 0.13 mm rechts, 0.61 mm hoch  
 Streuwert: 2.84, horizontal: 3.26, vertikal: 2.34

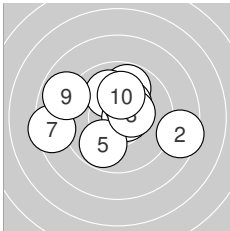
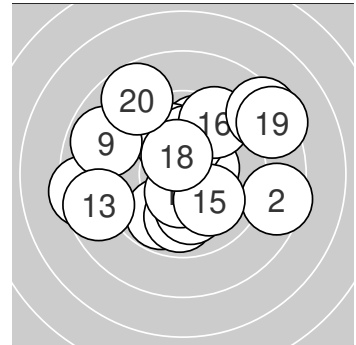

**Serie 1: 96.9 (92)**

9.8 ↗ 8.5 → 10.0 ↖ 10.7\* → 9.8 ↙  
 10.3\* ↗ 8.4 ← 10.4\* → 8.9 ↖ 10.1 ↑  
 beste Teiler: 75.1 (4.), 135.4 (8.), 157.4 (6.)  
 Trefferlage: 0.30 mm links, 0.54 mm hoch  
 Streuwert: 2.70, horizontal: 3.37, vertikal: 1.80

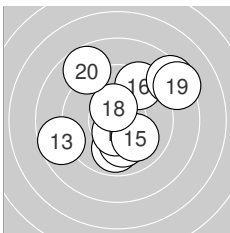

**Serie 2: 94.6 (90)**

9.9 ↓ 10.1 ↓ 8.7 ← 10.5\* ↓ 10.0 ↘  
 9.4 ↗ 8.4 ↗ 10.5\* ↖ 8.4 ↗ 8.7 ↖  
 beste Teiler: 113.2 (14.), 124.2 (18.), 222.2 (12.)  
 Trefferlage: 0.57 mm rechts, 0.67 mm hoch  
 Streuwert: 3.08, horizontal: 3.27, vertikal: 2.88





Ergebnis: **203.6** (195)  
 Serien: 102.1 101.5  
 Zähler: 15 5 0 0 0 0 0 0 0 0  
 Innenzehner: 13  
 Weitesten: 370 (19.), 322 (14.), 275 (5.)  
 beste Teiler: 14.7 (16.), 104.7 (10.), 107.6 (6.)  
 Trefferlage: 0.22 mm links, 0.15 mm hoch  
 Streuwert: 1.50, horizontal: 1.84, vertikal: 1.06

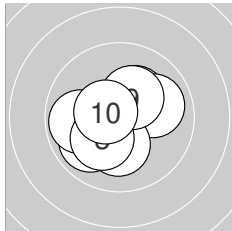
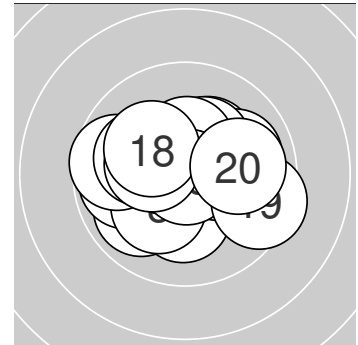

**Serie 1: 102.1 (98)**

9.9 ↙	10.4* ↗	10.2* ↗	10.0 →	9.9 ←
10.5* ↙	10.2* ↓	10.2* ↙	10.3* ↗	10.5* ↖

beste Teiler: 104.7 (10.), 107.6 (6.), 136.6 (2.)  
 Trefferlage: 0.24 mm links, 0.13 mm tief  
 Streuwert: 1.43, horizontal: 1.58, vertikal: 1.27

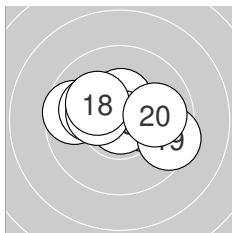

**Serie 2: 101.5 (97)**

10.3* →	10.2* ↖	10.4* ↑	9.7 ←	10.1 ↖
10.9* ↘	10.3* ↖	10.2* ↖	9.5 →	9.9 →

beste Teiler: 14.7 (16.), 139.2 (13.), 157.2 (11.)  
 Trefferlage: 0.20 mm links, 0.44 mm hoch  
 Streuwert: 1.61, horizontal: 2.15, vertikal: 0.77



Ergebnis: **200.5** (191)  
 Serien: 100.5 100.0  
 Zähler: 11 9 0 0 0 0 0 0 0 0 0  
 Innenzehner: 8  
 Weitester: 438 (18.), 370 (17.), 366 (9.)  
 beste Teiler: 75.3 (7.), 81.8 (4.), 100.6 (20.)  
 Trefferlage: 0.48 mm rechts, 0.66 mm tief  
 Streuwert: 1.74, horizontal: 1.92, vertikal: 1.54

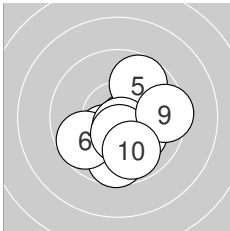
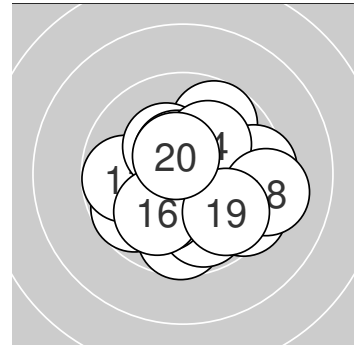

**Serie 1: 100.5 (95)**

10.1 ↘	10.3* ✓	9.7 ↓	10.6* ↘	9.7 ↗
9.7 ↙	10.7* ↓	10.4* ↓	9.5 →	9.8 ↓

beste Teiler: 75.3 (7.), 81.8 (4.), 127.8 (8.)  
 Trefferlage: 0.55 mm rechts, 0.94 mm tief  
 Streuwert: 1.62, horizontal: 1.65, vertikal: 1.60

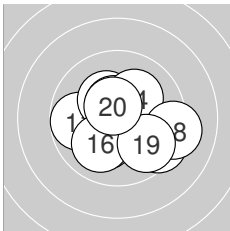

**Serie 2: 100.0 (96)**

9.8 ←	10.3* ↖	10.5* ↑	10.1 ↗	10.2* ✓
10.0 ✓	9.5 ↘	9.2 →	9.8 ↘	10.6* ↑

beste Teiler: 100.6 (20.), 109.2 (13.), 167.3 (12.)  
 Trefferlage: 0.41 mm rechts, 0.38 mm tief  
 Streuwert: 1.91, horizontal: 2.25, vertikal: 1.51



Ergebnis: **179.7** (168)  
 Serien: 94.3 85.4  
 Zähler: 3 9 4 2 1 1 0 0 0 0 0  
 Innenzehner: 3  
 Weitester: 1333 (12.), 1242 (13.), 816 (20.)  
 beste Teiler: 29.7 (3.), 114.2 (6.), 167.7 (11.)  
 Trefferlage: 2.42 mm links, 1.46 mm hoch  
 Streuwert: 3.77, horizontal: 4.50, vertikal: 2.85

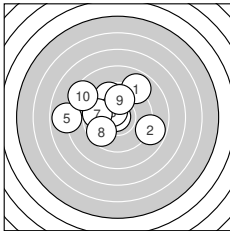
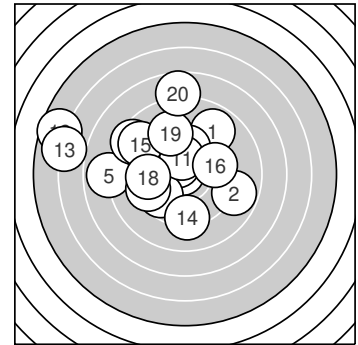

**Serie 1: 94.3 (87)**

8.9 ↗ 8.8 → 10.8\* ← 9.6 ↖ 7.9 ←  
 10.5\* ↘ 9.7 ← 9.7 ↙ 9.9 ↑ 8.5 ↘  
 beste Teiler: 29.7 (3.), 114.2 (6.), 269.9 (9.)  
 Trefferlage: 1.26 mm links, 1.06 mm hoch  
 Streuwert: 3.01, horizontal: 3.65, vertikal: 2.20

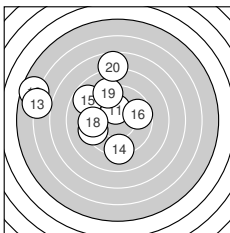

**Serie 2: 85.4 (81)**

10.3\* ↑ 5.6 ↖ 6.0 ← 9.2 ↓ 8.8 ↘  
 9.7 → 9.4 ↙ 9.5 ← 9.2 ↖ 7.7 ↑  
 beste Teiler: 167.7 (11.), 316.3 (16.), 372.9 (18.)  
 Trefferlage: 3.59 mm links, 1.85 mm hoch  
 Streuwert: 4.38, horizontal: 5.14, vertikal: 3.46



Ergebnis: **203.3** (194)  
 Serien: 100.6 102.7  
 Zähler: 14 6 0 0 0 0 0 0 0 0  
 Innenzehner: 11  
 Weitesten: 450 (19.), 357 (5.), 341 (1.)  
 beste Teiler: 32.7 (20.), 56.6 (15.), 61.9 (14.)  
 Trefferlage: 0.57 mm rechts, 0.03 mm tief  
 Streuwert: 1.59, horizontal: 2.03, vertikal: 0.99

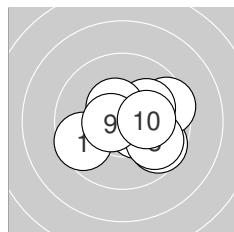
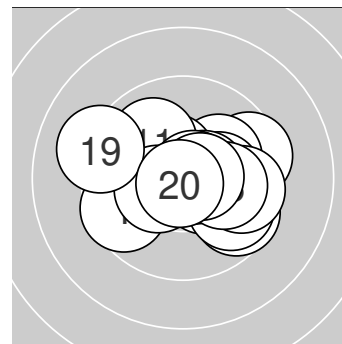

**Serie 1: 100.6 (96)**

9.6 ↙	9.7 ↘	10.2* →	10.4* ↘	9.5 →
10.1 ↗	10.5* ↖	9.8 ↘	10.6* ←	10.2* →

beste Teiler: 90.6 (9.), 122.5 (7.), 127.6 (4.)  
 Trefferlage: 1.06 mm rechts, 0.25 mm tief  
 Streuwert: 1.61, horizontal: 1.98, vertikal: 1.11

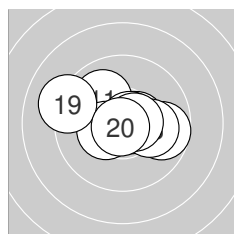

**Serie 2: 102.7 (98)**

10.0 ↖	9.7 →	10.5* →	10.7* →	10.7* →
10.1 →	10.4* ↙	10.6* →	9.2 ↖	10.8* ↙

beste Teiler: 32.7 (20.), 56.6 (15.), 61.9 (14.)  
 Trefferlage: 0.09 mm rechts, 0.19 mm hoch  
 Streuwert: 1.57, horizontal: 2.06, vertikal: 0.84



Ergebnis: **191.6** (182)  
 Serien: 97.2 94.4  
 Zähler: 7 10 2 0 1 0 0 0 0 0 0  
 Innenzehner: 5  
 Weitester: 1022 (1.), 594 (17.), 536 (13.)  
 beste Teiler: 98.8 (10.), 138.4 (19.), 139.0 (5.)  
 Trefferlage: 0.26 mm rechts, 1.03 mm hoch  
 Streuwert: 2.79, horizontal: 2.98, vertikal: 2.59

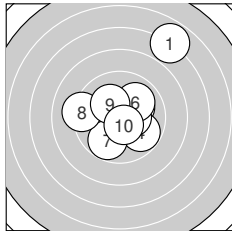
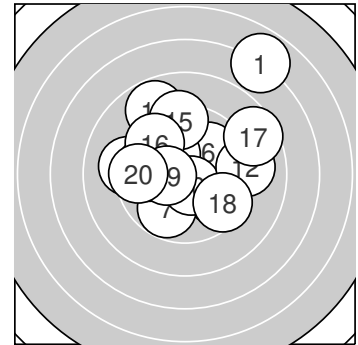

**Serie 1: 97.2 (93)**

6.9 ↗	10.1 ↗	10.2* ↘	9.8 ↘	10.4* →
10.0 ↗	9.8 ↘	9.2 ←	10.2* ↘	10.6* ↘

beste Teiler: 98.8 (10.), 139.0 (5.), 185.6 (9.)  
 Trefferlage: 0.84 mm rechts, 0.73 mm hoch  
 Streuwert: 2.87, horizontal: 2.68, vertikal: 3.06

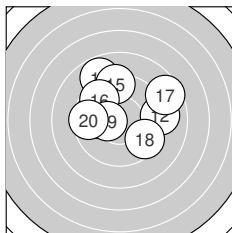

**Serie 2: 94.4 (89)**

9.8 ←	9.1 →	8.8 ↘	9.8 ←	9.3 ↑
9.6 ↘	8.6 ↗	9.5 ↘	10.4* ←	9.5 ←

beste Teiler: 138.4 (19.), 278.5 (11.), 298.8 (14.)  
 Trefferlage: 0.30 mm links, 1.33 mm hoch  
 Streuwert: 2.78, horizontal: 3.29, vertikal: 2.16



Ergebnis: **188.7** (177)  
 Serien: 95.9 92.8  
 Zähler: 3 12 4 1 0 0 0 0 0 0  
 Innenzehner: 3  
 Weitester: 841 (13.), 746 (8.), 655 (10.)  
 beste Teiler: 28.0 (3.), 56.8 (7.), 58.1 (1.)  
 Trefferlage: 1.21 mm rechts, 0.53 mm tief  
 Streuwert: 2.99, horizontal: 3.79, vertikal: 1.87

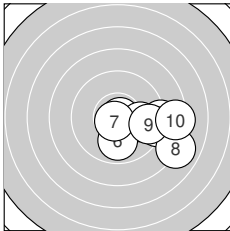
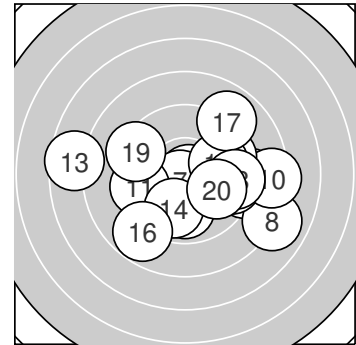

**Serie 1: 95.9 (91)**

10.7\* ↓                      9.0 →                      10.8\* →  
 9.9 ↓                          10.7\* ↙                      8.0 ↘

9.1 →                          9.9 →  
 9.5 →                          8.3 →

beste Teiler: 28.0 (3.), 56.8 (7.), 58.1 (1.)  
 Trefferlage: 2.87 mm rechts, 1.01 mm tief  
 Streuwert: 2.09, horizontal: 2.72, vertikal: 1.14

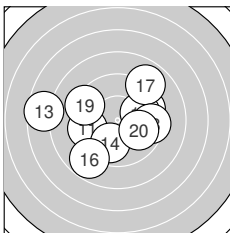

**Serie 2: 92.8 (86)**

9.5 ←                          9.6 →                          7.6 ←  
 8.8 ↙                          8.9 ↗                          9.4 →

9.9 ↓                          9.9 →  
 9.3 ↖                          9.9 ↘

beste Teiler: 265.2 (20.), 267.2 (15.), 270.3 (14.)  
 Trefferlage: 0.45 mm links, 0.04 mm tief  
 Streuwert: 3.34, horizontal: 4.09, vertikal: 2.36



Ergebnis: **186.4** (177)  
 Serien: 94.5 91.9  
 Zähler: 5 8 6 1 0 0 0 0 0 0 0  
 Innenezehner: 4  
 Weitester: 858 (20.), 690 (1.), 582 (17.)  
 beste Teiler: 133.3 (12.), 137.0 (8.), 148.9 (4.)  
 Trefferlage: 0.73 mm links, 0.98 mm hoch  
 Streuwert: 3.15, horizontal: 3.36, vertikal: 2.93

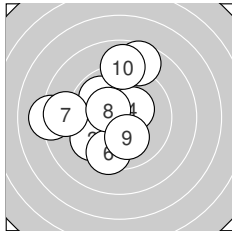
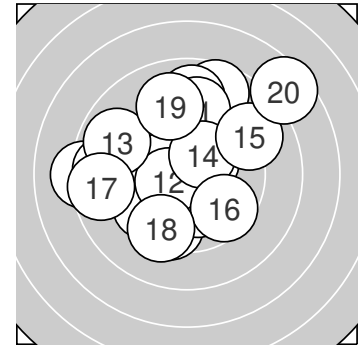

**Serie 1: 94.5 (89)**

8.2 ←      9.6 ↙      9.9 ↘      10.4\* ↗      8.7 ↑  
 9.5 ↓      8.8 ←      10.4\* ↘      10.1 ↓      8.9 ↑

beste Teiler: 137.0 (8.), 148.9 (4.), 212.3 (9.)  
 Trefferlage: 1.49 mm links, 0.65 mm hoch  
 Streuwert: 2.89, horizontal: 2.87, vertikal: 2.91

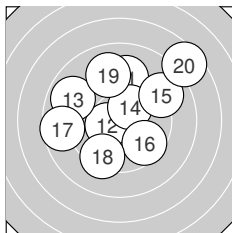

**Serie 2: 91.9 (88)**

9.2 ↑      10.4\* ←      8.9 ↘      10.3\* ↗      9.0 ↗  
 9.6 ↘      8.6 ←      9.3 ↓      9.1 ↑      7.5 ↗

beste Teiler: 133.3 (12.), 167.2 (14.), 337.6 (16.)  
 Trefferlage: 0.02 mm rechts, 1.31 mm hoch  
 Streuwert: 3.44, horizontal: 3.78, vertikal: 3.07



Ergebnis: **199.1** (192)  
 Serien: 99.8 99.3  
 Zähler: 12 8 0 0 0 0 0 0 0 0  
 Innenzehner: 7  
 Weitesten: 431 (19.), 414 (7.), 362 (15.)  
 beste Teiler: 116.8 (4.), 128.3 (5.), 140.6 (14.)  
 Trefferlage: 0.21 mm links, 0.36 mm tief  
 Streuwert: 1.91, horizontal: 2.19, vertikal: 1.57

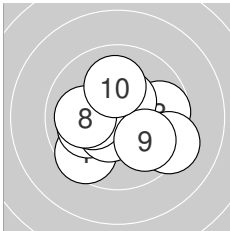
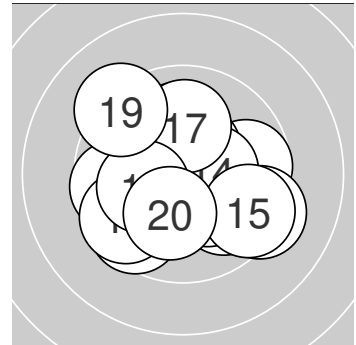

**Serie 1: 99.8 (96)**

9.6 ↙ 10.1 ← 9.7 →  
 10.2\* ← 9.3 ↘ 10.0 ←  
 beste Teiler: 116.8 (4.), 128.3 (5.), 179.2 (6.)  
 Trefferlage: 0.00 mm , 0.40 mm tief  
 Streuwert: 1.90, horizontal: 2.26, vertikal: 1.45

10.5\* ↙ 10.4\* ↗  
 9.9 ↘ 10.1 ↑

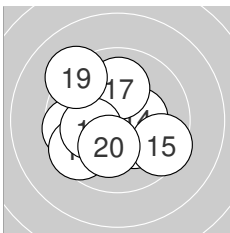

**Serie 2: 99.3 (96)**

10.3\* ↘ 10.4\* ↘ 9.6 ←  
 9.6 ↙ 10.0 ↑ 10.1 ←  
 beste Teiler: 140.6 (14.), 150.7 (12.), 172.5 (11.)  
 Trefferlage: 0.43 mm links, 0.33 mm tief  
 Streuwert: 2.00, horizontal: 2.22, vertikal: 1.75

10.4\* → 9.5 ↘  
 9.2 ↘ 10.2\* ↙





Ergebnis: **189.6** (181)  
 Serien: 93.9 95.7  
 Zähler: 10 5 1 4 0 0 0 0 0 0 0  
 Innenzehner: 7  
 Weitest: 911 (16.), 895 (3.), 849 (5.)  
 beste Teiler: 23.3 (6.), 42.1 (8.), 82.3 (10.)  
 Trefferlage: 0.63 mm rechts, 0.35 mm tief  
 Streuwert: 3.34, horizontal: 4.40, vertikal: 1.70

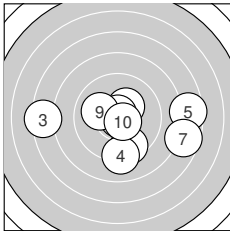
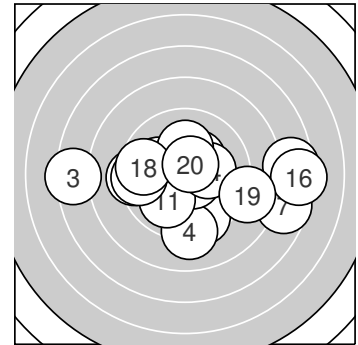

**Serie 1: 93.9 (89)**

10.3\* ↗ 9.5 ↓ 7.4 ← 9.1 ↓ 7.6 →  
 10.9\* ↓ 7.6 → 10.8\* ↑ 10.1 ← 10.6\* ↘  
 beste Teiler: 23.3 (6.), 42.1 (8.), 82.3 (10.)  
 Trefferlage: 0.88 mm rechts, 0.83 mm tief  
 Streuwert: 3.72, horizontal: 4.88, vertikal: 1.97

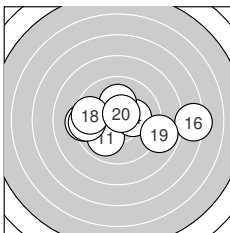

**Serie 2: 95.7 (92)**

10.0 ↙ 9.3 ← 9.5 ← 10.2\* → 10.2\* ↑  
 7.3 → 10.1 ↑ 9.6 ← 8.9 → 10.6\* ↗  
 beste Teiler: 90.4 (20.), 186.2 (14.), 192.0 (15.)  
 Trefferlage: 0.39 mm rechts, 0.12 mm hoch  
 Streuwert: 3.06, horizontal: 4.12, vertikal: 1.33



Ergebnis: **196.3** (187)  
 Serien: 99.0 97.3  
 Zähler: 10 7 3 0 0 0 0 0 0 0 0  
 Innenzehner: 8  
 Weitestе: 684 (13.), 574 (3.), 554 (11.)  
 beste Teiler: 66.4 (9.), 98.8 (14.), 117.0 (8.)  
 Trefferlage: 1.09 mm links, 0.64 mm hoch  
 Streuwert: 2.27, horizontal: 2.24, vertikal: 2.30

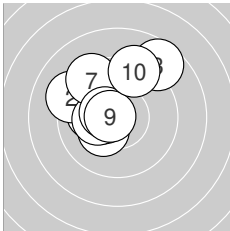
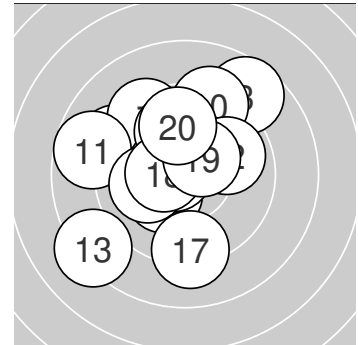

**Serie 1: 99.0 (95)**

10.1 ←	9.2 ↖	8.7 ↗	10.3* ↙	10.5* ←
10.3* ←	9.4 ↘	10.5* ←	10.7* ←	9.3 ↗

beste Teiler: 66.4 (9.), 117.0 (8.), 117.1 (5.)  
 Trefferlage: 0.94 mm links, 1.30 mm hoch  
 Streuwert: 2.03, horizontal: 2.08, vertikal: 1.99

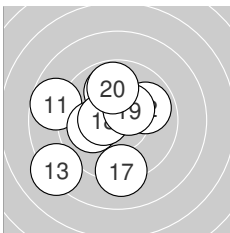

**Serie 2: 97.3 (92)**

8.7 ←	9.9 →	8.2 ↙	10.6* ↖	9.9 ↑
10.1 ←	9.2 ↓	10.5* ←	10.4* ↗	9.8 ↑

beste Teiler: 98.8 (14.), 123.1 (18.), 135.0 (19.)  
 Trefferlage: 1.23 mm links, 0.00 mm  
 Streuwert: 2.50, horizontal: 2.50, vertikal: 2.49



Ergebnis: **198.7** (192)  
 Serien: 99.9 98.8  
 Zähler: 12 8 0 0 0 0 0 0 0 0 0  
 Innenzehner: 10  
 Weitesten: 471 (5.), 452 (20.), 419 (10.)  
 beste Teiler: 48.8 (4.), 125.9 (1.), 141.1 (12.)  
 Trefferlage: 0.18 mm rechts, 0.56 mm hoch  
 Streuwert: 2.00, horizontal: 1.68, vertikal: 2.29

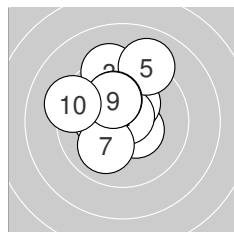
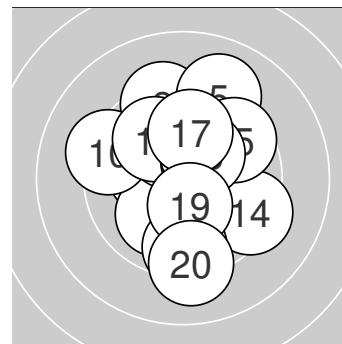

**Serie 1: 99.9 (97)**

10.5* ↘	10.3* ↗	9.3 ↑	10.8* ↗	9.1 ↑
10.2* ←	10.0 ✓	10.2* ↘	10.2* ↘	9.3 ←

beste Teiler: 48.8 (4.), 125.9 (1.), 161.9 (2.)  
 Trefferlage: 0.55 mm links, 1.25 mm hoch  
 Streuwert: 1.78, horizontal: 1.67, vertikal: 1.89

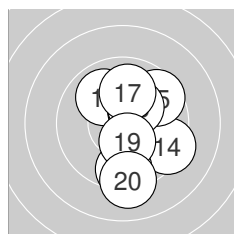

**Serie 2: 98.8 (95)**

9.9 ↘	10.4* ↗	10.2* ↗	9.4 ↘	9.6 ↗
10.3* ↗	10.0 ↑	9.5 ↓	10.4* ↓	9.1 ↓

beste Teiler: 141.1 (12.), 148.6 (19.), 164.9 (16.)  
 Trefferlage: 0.91 mm rechts, 0.12 mm tief  
 Streuwert: 2.04, horizontal: 1.39, vertikal: 2.53



Ergebnis: **193.5** (183)  
 Serien: 96.5 97.0  
 Zähler: 8 7 5 0 0 0 0 0 0 0  
 Innenzehner: 7  
 Weitestе: 597 (12.), 580 (17.), 569 (9.)  
 beste Teiler: 81.8 (15.), 124.0 (5.), 132.1 (11.)  
 Trefferlage: 0.10 mm rechts, 0.90 mm hoch  
 Streuwert: 2.52, horizontal: 3.00, vertikal: 1.92

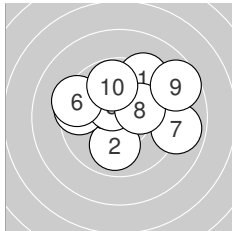
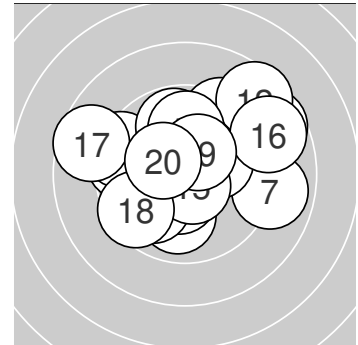

**Serie 1: 96.5 (92)**

9.3 ↗	10.0 ↓	10.3* ↘	9.5 ←	10.5* ↖
9.3 ↖	8.9 →	10.2* →	8.7 ↗	9.8 ↑

beste Teiler: 124.0 (5.), 160.7 (3.), 194.4 (8.)  
 Trefferlage: 0.37 mm rechts, 1.07 mm hoch  
 Streuwert: 2.51, horizontal: 3.07, vertikal: 1.78

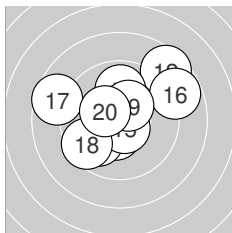

**Serie 2: 97.0 (91)**

10.4* ↓	8.6 ↗	9.9 ↑	9.9 ↙	10.6* ↘
8.8 ↗	8.6 ↖	9.5 ↙	10.4* ↗	10.3* ↖

beste Teiler: 81.8 (15.), 132.1 (11.), 149.3 (19.)  
 Trefferlage: 0.16 mm links, 0.73 mm hoch  
 Streuwert: 2.65, horizontal: 3.08, vertikal: 2.14



Ergebnis: **193.5** (183)  
 Serien: 92.9 100.6  
 Zähler: 9 7 2 2 0 0 0 0 0 0 0  
 Innenzehner: 7  
 Weitestе: 903 (6.), 808 (10.), 558 (2.)  
 beste Teiler: 74.4 (3.), 87.8 (14.), 93.6 (19.)  
 Trefferlage: 1.06 mm rechts, 0.54 mm tief  
 Streuwert: 2.71, horizontal: 3.06, vertikal: 2.30

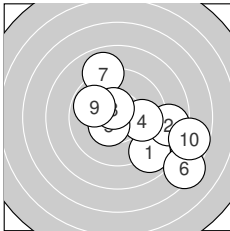
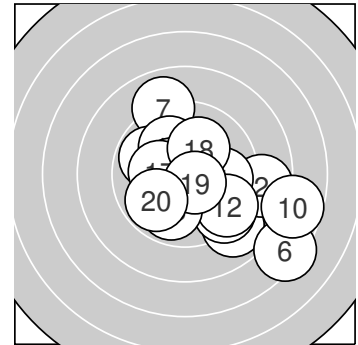

**Serie 1: 92.9 (87)**

8.9 ↘      8.7 →      10.7\* ↖      9.9 →      10.4\* ↙  
 7.3 ↘      9.0 ↑      10.5\* ↖      9.8 ↖      7.7 →

beste Teiler: 74.4 (3.), 105.1 (8.), 126.6 (5.)  
 Trefferlage: 2.05 mm rechts, 0.61 mm tief  
 Streuwert: 3.34, horizontal: 3.79, vertikal: 2.83

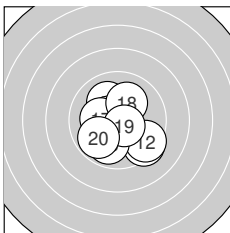

**Serie 2: 100.6 (96)**

9.4 ↘      9.4 ↘      9.9 ↙      10.6\* ↑      10.1 ↖  
 10.5\* ↖      10.2\* ←      10.1 ↗      10.6\* ↘      9.8 ↙

beste Teiler: 87.8 (14.), 93.6 (19.), 104.0 (16.)  
 Trefferlage: 0.06 mm rechts, 0.47 mm tief  
 Streuwert: 1.79, horizontal: 1.80, vertikal: 1.77



Ergebnis: **168.4** (160)  
 Serien: 85.6 82.8  
 Zähler: 2 8 1 6 3 0 0 0 0 0 0  
 Innenzehner: 2  
 Weitester: 1220 (13.), 1087 (11.), 1040 (12.)  
 beste Teiler: 141.3 (6.), 175.8 (15.), 317.6 (20.)  
 Trefferlage: 0.77 mm links, 1.23 mm hoch  
 Streuwert: 5.02, horizontal: 5.39, vertikal: 4.62

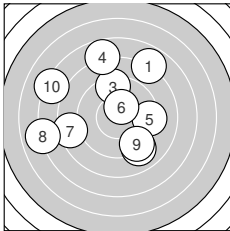
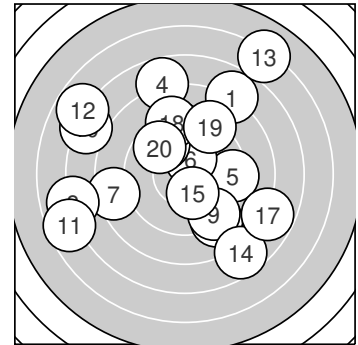

**Serie 1: 85.6 (82)**

7.9 ↗ 9.0 ↘ 9.3 ↑ 7.8 ↑ 9.3 →  
 10.4\* ↑ 8.4 ← 7.0 ← 9.3 ↘ 7.2 ↖  
 beste Teiler: 141.3 (6.), 403.4 (3.), 411.3 (5.)  
 Trefferlage: 1.30 mm links, 1.19 mm hoch  
 Streuwert: 4.70, horizontal: 5.13, vertikal: 4.22

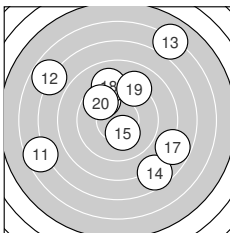

**Serie 2: 82.8 (78)**

6.6 ← 6.8 ↖ 6.1 ↗ 7.6 ↘ 10.3\* ↘  
 9.7 ↖ 7.8 ↗ 9.1 ↑ 9.1 ↑ 9.7 ↖  
 beste Teiler: 175.8 (15.), 317.6 (20.), 317.9 (16.)  
 Trefferlage: 0.24 mm links, 1.28 mm hoch  
 Streuwert: 5.55, horizontal: 5.87, vertikal: 5.21



Ergebnis: **201.7** (192)  
 Serien: 101.0 100.7  
 Zähler: 12 8 0 0 0 0 0 0 0 0  
 Innenzehner: 8  
 Weitesten: 388 (11.), 368 (16.), 324 (6.)  
 beste Teiler: 61.2 (17.), 72.6 (7.), 77.3 (19.)  
 Trefferlage: 0.10 mm rechts, 0.77 mm tief  
 Streuwert: 1.63, horizontal: 1.88, vertikal: 1.35

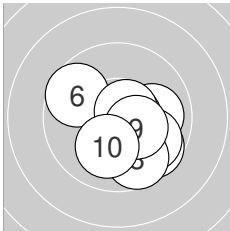
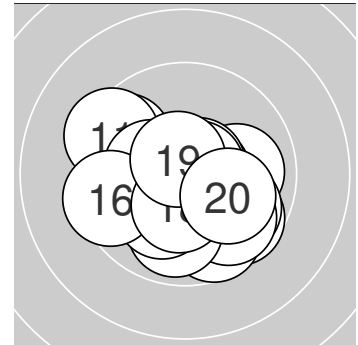

**Serie 1: 101.0 (96)**

9.7 ↘	10.0 →	10.6* →	9.8 ↘	10.3* ↓
9.7 ↖	10.7* ↗	9.7 ↓	10.4* ↗	10.1 ↓

beste Teiler: 72.6 (7.), 85.0 (3.), 149.0 (9.)  
 Trefferlage: 0.80 mm rechts, 0.85 mm tief  
 Streuwert: 1.51, horizontal: 1.64, vertikal: 1.37

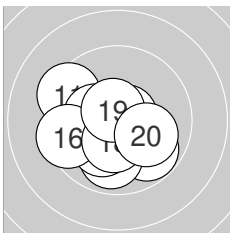

**Serie 2: 100.7 (96)**

9.4 ↖	9.8 ↘	10.3* ←	9.9 ↓	10.1 ↓
9.5 ←	10.7* ↗	10.4* ↓	10.6* ↘	10.0 ↘

beste Teiler: 61.2 (17.), 77.3 (19.), 147.6 (18.)  
 Trefferlage: 0.60 mm links, 0.69 mm tief  
 Streuwert: 1.68, horizontal: 1.92, vertikal: 1.39



Ergebnis: **203.6** (193)  
 Serien: 102.4 101.2  
 Zähler: 13 7 0 0 0 0 0 0 0 0  
 Innenzehner: 12  
 Weitester: 468 (18.), 432 (10.), 386 (12.)  
 beste Teiler: 6.0 (11.), 33.1 (13.), 46.2 (3.)  
 Trefferlage: 0.35 mm rechts, 0.16 mm hoch  
 Streuwert: 1.73, horizontal: 1.81, vertikal: 1.65

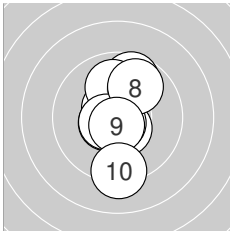
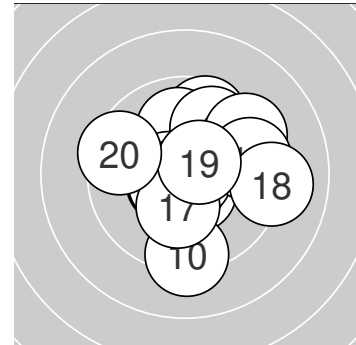

**Serie 1: 102.4 (97)**

10.5* ↘	10.6* ↖	10.8* ↓	10.5* ↙	9.7 ↑
10.0 ↑	10.6* ↙	9.8 ↗	10.7* ↓	9.2 ↓

beste Teiler: 46.2 (3.), 64.4 (9.), 97.6 (7.)  
 Trefferlage: 0.02 mm rechts, 0.15 mm hoch  
 Streuwert: 1.63, horizontal: 0.80, vertikal: 2.16

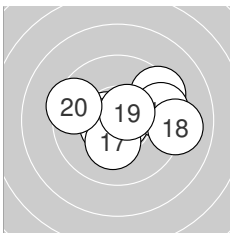

**Serie 2: 101.2 (96)**

10.9* →	9.4 ↗	10.8* ↘	10.6* ←	10.6* ↙
9.5 →	10.2* ↓	9.1 →	10.6* ↗	9.5 ↖

beste Teiler: 6.0 (11.), 33.1 (13.), 88.0 (14.)  
 Trefferlage: 0.69 mm rechts, 0.18 mm hoch  
 Streuwert: 1.89, horizontal: 2.45, vertikal: 1.05





Ergebnis: **194.7** (188)  
 Serien: 96.8 97.9  
 Zähler: 11 6 3 0 0 0 0 0 0 0  
 Innenzehner: 7  
 Weitester: 683 (2.), 545 (4.), 526 (18.)  
 beste Teiler: 136.0 (1.), 146.0 (14.), 170.0 (13.)  
 Trefferlage: 0.81 mm links, 0.30 mm tief  
 Streuwert: 2.41, horizontal: 1.98, vertikal: 2.76

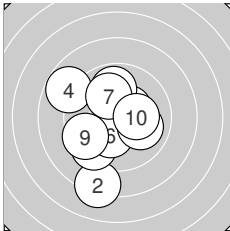
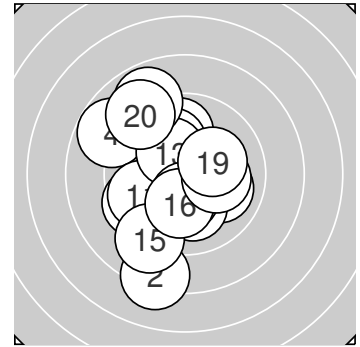

**Serie 1: 96.8 (93)**

10.4\* ↗ 8.2 ↓ 9.5 ↘ 8.8 ↖ 9.9 ↑  
 10.2\* ↓ 10.1 ↖ 10.0 → 9.5 ↙ 10.2\* →  
 beste Teiler: 136.0 (1.), 182.0 (10.), 182.7 (6.)  
 Trefferlage: 0.89 mm links, 0.55 mm tief  
 Streuwert: 2.57, horizontal: 2.22, vertikal: 2.88

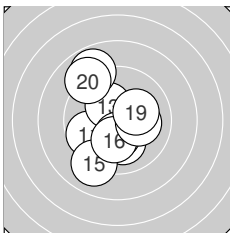

**Serie 2: 97.9 (95)**

9.7 ↙ 10.1 ↓ 10.3\* ↘ 10.4\* ↓ 9.1 ↓  
 10.2\* ↓ 10.1 → 8.8 ↖ 10.2\* → 9.0 ↖  
 beste Teiler: 146.0 (14.), 170.0 (13.), 193.0 (16.)  
 Trefferlage: 0.72 mm links, 0.04 mm tief  
 Streuwert: 2.35, horizontal: 1.84, vertikal: 2.77



Ergebnis: **199.0** (189)  
 Serien: 97.8 101.2  
 Zähler: 10 9 1 0 0 0 0 0 0 0 0  
 Innenzehner: 8  
 Weitestе: 518 (7.), 392 (3.), 373 (14.)  
 beste Teiler: 70.0 (16.), 108.5 (1.), 118.4 (11.)  
 Trefferlage: 0.50 mm rechts, 0.35 mm hoch  
 Streuwert: 1.96, horizontal: 2.42, vertikal: 1.35

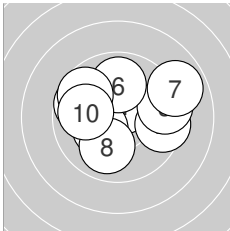
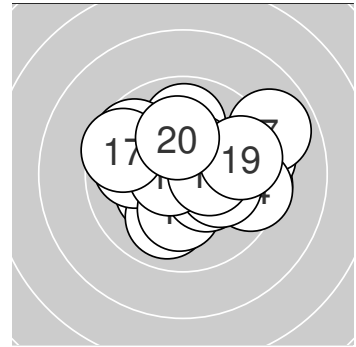

**Serie 1: 97.8 (92)**

10.5\* ↗ 9.5 → 9.4 → 9.7 ↖ 10.3\* ↙  
 9.9 ↑ 8.9 ↘ 10.0 ↓ 9.7 ↖ 9.9 ↖  
 beste Teiler: 108.5 (1.), 167.2 (5.), 245.2 (8.)  
 Trefferlage: 0.23 mm rechts, 0.62 mm hoch  
 Streuwert: 2.29, horizontal: 2.86, vertikal: 1.52

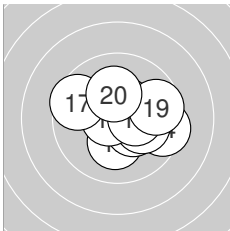

**Serie 2: 101.2 (97)**

10.5\* ↗ 10.2\* ↓ 10.3\* ↘ 9.5 → 10.1 →  
 10.7\* ← 9.6 ↖ 10.4\* → 9.7 → 10.2\* ↑  
 beste Teiler: 70.0 (16.), 118.4 (11.), 143.0 (18.)  
 Trefferlage: 0.76 mm rechts, 0.09 mm hoch  
 Streuwert: 1.64, horizontal: 2.00, vertikal: 1.17



Ergebnis: **188.1** (178)  
 Serien: 89.9 98.2  
 Zähler: 8 5 5 1 1 0 0 0 0 0 0  
 Innenzehner: 7  
 Weitester: 1115 (1.), 776 (3.), 642 (19.)  
 beste Teiler: 86.3 (8.), 100.1 (15.), 107.7 (13.)  
 Trefferlage: 0.37 mm links, 0.91 mm hoch  
 Streuwert: 3.34, horizontal: 4.42, vertikal: 1.66

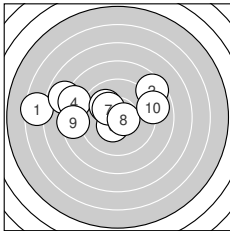
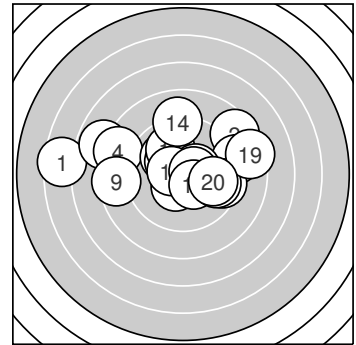

**Serie 1: 89.9 (85)**

6.5 ←                      8.5 ↗                      7.8 ↖  
 10.4\* ↙                      10.3\* ↘                      10.6\* →  
 beste Teiler: 86.3 (8.), 132.2 (6.), 172.6 (7.)  
 Trefferlage: 2.36 mm links, 1.16 mm hoch  
 Streuwert: 3.84, horizontal: 5.22, vertikal: 1.51

8.4 ↖                      10.0 ↘  
 8.5 ←                      8.9 →

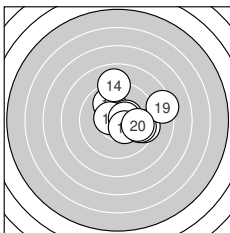

**Serie 2: 98.2 (93)**

9.9 ↘                      10.4\* →                      10.5\* ←  
 10.4\* ↘                      9.5 →                      9.7 →  
 beste Teiler: 100.1 (15.), 107.7 (13.), 128.0 (12.)  
 Trefferlage: 1.60 mm rechts, 0.66 mm hoch  
 Streuwert: 2.09, horizontal: 2.32, vertikal: 1.84

9.0 ↑                      10.6\* →  
 8.4 →                      9.8 →



Ergebnis: **181.0** (173)  
 Serien: 86.1 94.9  
 Zähler: 8 4 3 3 2 0 0 0 0 0 0  
 Innenzehner: 3  
 Weitester: 1113 (2.), 1086 (17.), 845 (6.)  
 beste Teiler: 102.5 (9.), 125.0 (20.), 165.6 (19.)  
 Trefferlage: 1.07 mm links, 1.18 mm hoch  
 Streuwert: 3.98, horizontal: 5.21, vertikal: 2.11

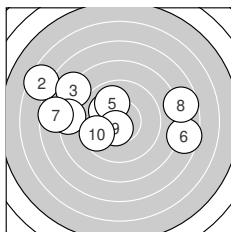
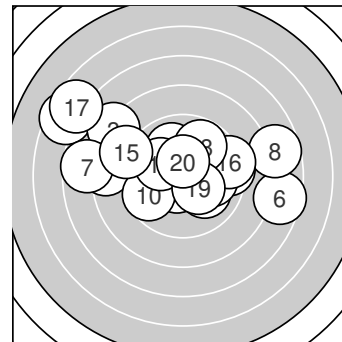

**Serie 1: 86.1 (82)**

10.1 ↖	6.5 ↖	8.1 ↖	8.3 ←	10.0 ↗
7.6 →	7.7 ←	7.7 →	10.5* ↘	9.6 ↙

beste Teiler: 102.5 (9.), 214.4 (1.), 247.9 (5.)  
 Trefferlage: 2.06 mm links, 1.17 mm hoch  
 Streuwert: 4.65, horizontal: 6.18, vertikal: 2.25

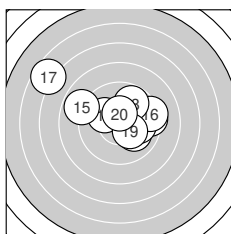

**Serie 2: 94.9 (91)**

9.4 →	10.0 ↘	10.0 →	10.1 ↖	8.9 ↖
9.3 →	6.6 ↖	9.8 ↗	10.3* ↘	10.5* ↑

beste Teiler: 125.0 (20.), 165.6 (19.), 215.6 (14.)  
 Trefferlage: 0.09 mm links, 1.18 mm hoch  
 Streuwert: 3.27, horizontal: 4.13, vertikal: 2.08



Ergebnis: **191.7** (185)  
 Serien: 95.5 96.2  
 Zähler: 9 8 2 1 0 0 0 0 0 0 0  
 Innenzehner: 8  
 Weitest: 874 (5.), 719 (12.), 535 (14.)  
 beste Teiler: 32.2 (4.), 127.7 (2.), 128.0 (20.)  
 Trefferlage: 0.49 mm links, 1.15 mm hoch  
 Streuwert: 2.77, horizontal: 3.43, vertikal: 1.89

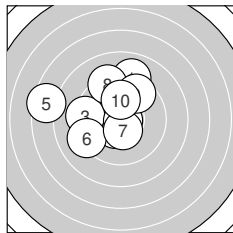
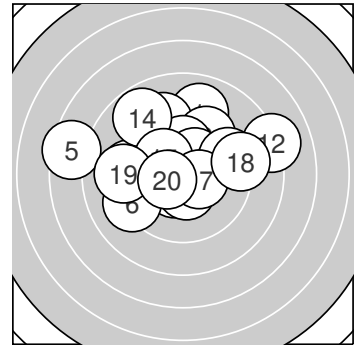

**Serie 1: 95.5 (92)**

9.0 ↑      10.4\* ↙      9.3 ←      10.8\* ↘      7.5 ←  
 9.2 ↙      10.4\* ↓      9.2 ↗      9.6 ↗      10.1 ↑  
 beste Teiler: 32.2 (4.), 127.7 (2.), 128.8 (7.)  
 Trefferlage: 1.50 mm links, 1.14 mm hoch  
 Streuwert: 2.79, horizontal: 3.16, vertikal: 2.36

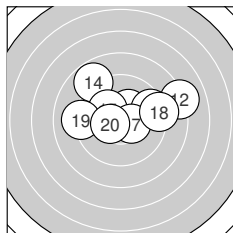

**Serie 2: 96.2 (93)**

10.3\* ↘      8.1 →      10.3\* ↗      8.8 ↘      10.2\* ↘  
 9.5 →      10.4\* ↘      9.1 →      9.1 ←      10.4\* ↙  
 beste Teiler: 128.0 (20.), 130.2 (17.), 152.0 (11.)  
 Trefferlage: 0.51 mm rechts, 1.16 mm hoch  
 Streuwert: 2.70, horizontal: 3.55, vertikal: 1.41

