

Ergebnis: **199.0** (190)
 Serien: 101.2 97.8
 Zähler: 11 8 1 0 0 0 0 0 0 0
 Innenzehner: 7
 Weitester: 517 (10.), 467 (16.), 438 (20.)
 beste Teiler: 12.0 (4.), 19.1 (8.), 109.6 (15.)
 Trefferlage: 1.05 mm rechts, 0.70 mm tief
 Streuwert: 1.85, horizontal: 2.09, vertikal: 1.58

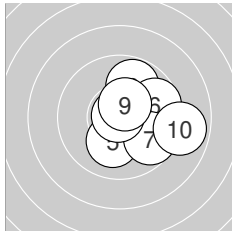
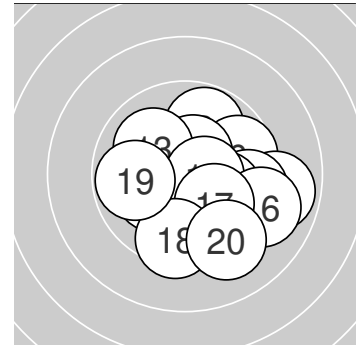

Serie 1: 101.2 (95)

10.4* ↓	9.8 ↑	10.3* →	10.9* ↗	10.1 ↓
9.7 →	9.7 ↘	10.9* ↖	10.5* ↑	8.9 →

beste Teiler: 12.0 (4.), 19.1 (8.), 117.9 (9.)
 Trefferlage: 1.30 mm rechts, 0.13 mm tief
 Streuwert: 1.63, horizontal: 1.79, vertikal: 1.46

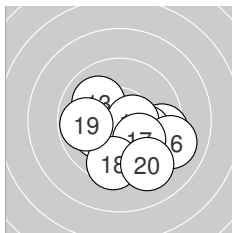

Serie 2: 97.8 (95)

9.5 →	10.2* ↙	10.0 ↘	10.0 →	10.5* →
9.1 →	10.0 ↘	9.5 ↓	9.8 ←	9.2 ↘

beste Teiler: 109.6 (15.), 198.9 (12.), 230.0 (14.)
 Trefferlage: 0.81 mm rechts, 1.26 mm tief
 Streuwert: 2.04, horizontal: 2.42, vertikal: 1.57



Ergebnis: **187.8** (179)
 Serien: 93.4 94.4
 Zähler: 5 9 6 0 0 0 0 0 0 0 0
 Innenzehner: 4
 Weitestе: 708 (17.), 697 (9.), 600 (11.)
 beste Teiler: 104.0 (20.), 153.3 (5.), 184.2 (2.)
 Trefferlage: 0.34 mm rechts, 0.32 mm tief
 Streuwert: 3.09, horizontal: 4.04, vertikal: 1.64

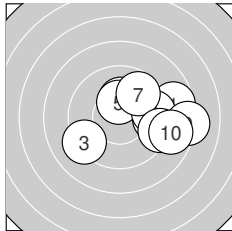
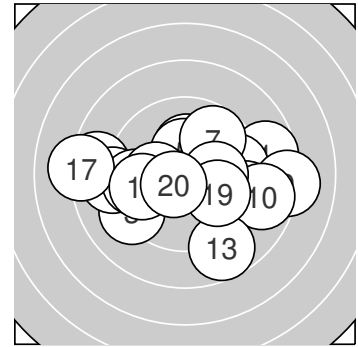

Serie 1: 93.4 (89)

8.7 → 10.2* ↑ 9.2 ↙ 9.5 → 10.3* ↑
 9.6 → 9.7 ↗ 9.2 → 8.2 → 8.8 →

beste Teiler: 153.3 (5.), 184.2 (2.), 305.4 (7.)
 Trefferlage: 2.70 mm rechts, 0.14 mm hoch
 Streuwert: 2.52, horizontal: 3.17, vertikal: 1.65

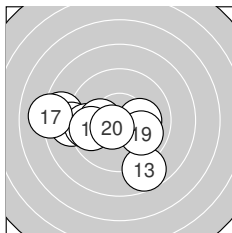

Serie 2: 94.4 (90)

8.6 ← 9.0 ← 8.7 ↓ 10.1 → 9.6 ←
 10.2* ← 8.1 ← 9.7 ← 9.9 → 10.5* ↘

beste Teiler: 104.0 (20.), 198.1 (16.), 205.0 (14.)
 Trefferlage: 2.02 mm links, 0.78 mm tief
 Streuwert: 2.70, horizontal: 3.47, vertikal: 1.59



Ergebnis: **189.9** (180)
 Serien: 95.8 94.1
 Zähler: 7 9 2 1 1 0 0 0 0 0 0
 Innenzehner: 6
 Weitestе: 1168 (17.), 776 (6.), 613 (11.)
 beste Teiler: 61.5 (7.), 100.9 (1.), 116.4 (18.)
 Trefferlage: 2.16 mm rechts, 1.20 mm hoch
 Streuwert: 2.68, horizontal: 3.41, vertikal: 1.64

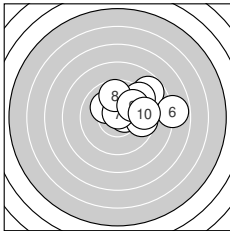
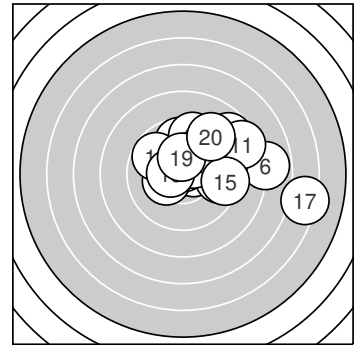

Serie 1: 95.8 (90)

10.6* →	9.6 →	8.7 ↗	9.3 ↗	10.1 ↖
7.8 →	10.7* ↑	9.7 ↑	9.9 ↗	9.4 →

beste Teiler: 61.5 (7.), 100.9 (1.), 211.9 (5.)
 Trefferlage: 2.34 mm rechts, 1.38 mm hoch
 Streuwert: 2.13, horizontal: 2.71, vertikal: 1.31

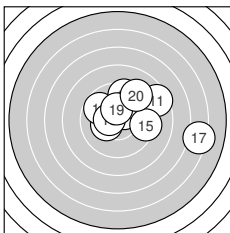

Serie 2: 94.1 (90)

8.5 ↗	10.4* ↗	10.3* ←	9.8 ↖	9.3 →
9.5 ↑	6.3 →	10.5* ←	10.3* ↑	9.2 ↗

beste Teiler: 116.4 (18.), 131.5 (12.), 159.5 (19.)
 Trefferlage: 1.99 mm rechts, 1.02 mm hoch
 Streuwert: 3.25, horizontal: 4.15, vertikal: 1.97



Ergebnis: **188.6** (179)
 Serien: 96.3 92.3
 Zähler: 6 10 2 1 1 0 0 0 0 0 0
 Innenzehner: 5
 Weitester: 1045 (11.), 809 (7.), 686 (19.)
 beste Teiler: 25.8 (3.), 152.7 (4.), 170.8 (8.)
 Trefferlage: 2.62 mm links, 0.05 mm tief
 Streuwert: 2.65, horizontal: 3.40, vertikal: 1.59

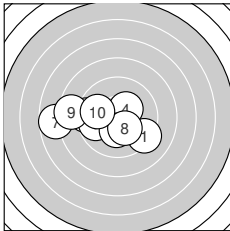
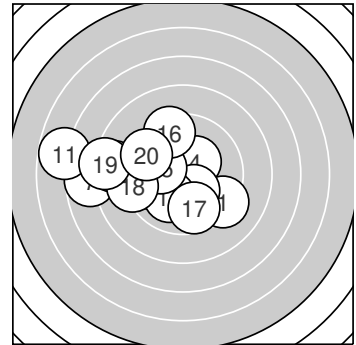

Serie 1: 96.3 (91)

9.3 ↘ 9.3 ← 10.9* ↗
 10.3* ↓ 7.7 ← 10.3* ↘
 beste Teiler: 25.8 (3.), 152.7 (4.), 170.8 (8.)
 Trefferlage: 1.82 mm links, 0.39 mm tief
 Streuwert: 2.66, horizontal: 3.57, vertikal: 1.18

10.3* ↗ 9.8 ←
 8.5 ← 9.9 ←

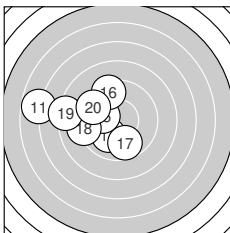

Serie 2: 92.3 (88)

6.8 ← 9.7 ← 9.7 ←
 9.4 ↗ 9.7 ↓ 9.1 ←
 beste Teiler: 199.4 (15.), 227.9 (14.), 309.2 (17.)
 Trefferlage: 3.42 mm links, 0.27 mm hoch
 Streuwert: 2.63, horizontal: 3.19, vertikal: 1.92

10.0 ↙ 10.2* ←
 8.2 ← 9.5 ↘



Ergebnis: **194.0** (187)
 Serien: 93.4 100.6
 Zähler: 11 7 0 2 0 0 0 0 0 0
 Innenzehner: 9
 Weitestе: 981 (5.), 891 (3.), 469 (19.)
 beste Teiler: 90.9 (2.), 129.3 (14.), 133.0 (13.)
 Trefferlage: 2.22 mm links, 0.36 mm tief
 Streuwert: 2.33, horizontal: 3.10, vertikal: 1.13

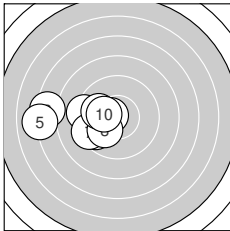
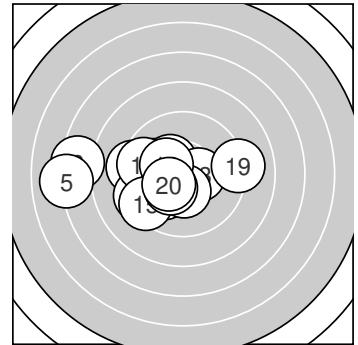

Serie 1: 93.4 (90)

9.3 ←	10.6* ←	7.4 ←	9.8 ←	7.0 ←
9.6 ↙	9.3 ↙	10.1 ↘	10.0 ←	10.3* ←

beste Teiler: 90.9 (2.), 175.3 (10.), 225.5 (8.)
 Trefferlage: 3.82 mm links, 0.43 mm tief
 Streuwert: 2.31, horizontal: 3.07, vertikal: 1.14

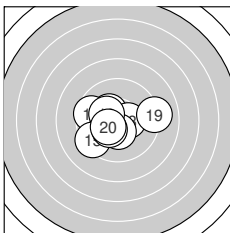

Serie 2: 100.6 (97)

10.3* ↘	9.6 ←	10.4* →	10.4* ←	9.4 ↙
10.4* ↓	10.3* ↙	10.3* ↘	9.1 →	10.4* ↙

beste Teiler: 129.3 (14.), 133.0 (13.), 143.3 (16.)
 Trefferlage: 0.62 mm links, 0.30 mm tief
 Streuwert: 1.82, horizontal: 2.29, vertikal: 1.18



Ergebnis: 175.8 (167)
Serien: 85.9 89.9
Zähler: 4 8 4 1 2 0 1 0 0 0 0
Innenzehner: 2
Weiteste: 1638 (8.), 1179 (12.), 1176 (1.)
beste Teiler: 151.3 (5.), 169.1 (2.), 224.4 (3.)
Trefferlage: 1.14 mm links, 0.23 mm tief
Streuwert: 4.72, horizontal: 6.27, vertikal: 2.30

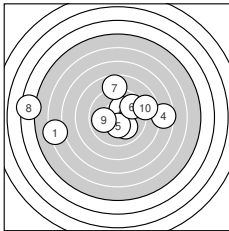
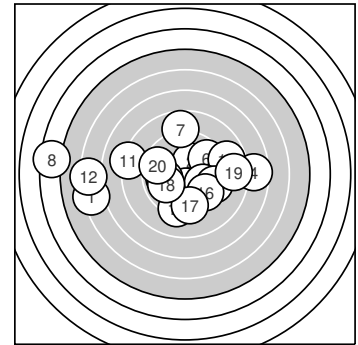

Serie 1: 85.9 (81)

6.2 ←	10.3* ↗	10.1 ↘	7.6 →	10.3* ↓
9.6 ↗	8.7 ↑	4.4 ←	9.9 ←	8.8 →

beste Teiler: 151.3 (5.), 169.1 (2.), 224.4 (3.)
Trefferlage: 1.24 mm links, 0.63 mm hoch
Streuwert: 5.51, horizontal: 7.41, vertikal: 2.41

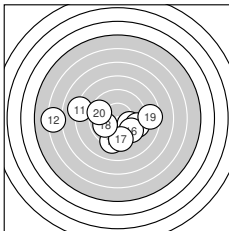

Serie 2: 89.9 (86)

8.1 ←	6.2 ←	10.0 ↘	9.4 →	9.2 ↓
9.6 ↘	9.4 ↓	9.9 ←	8.6 →	9.5 ←

beste Teiler: 241.5 (13.), 260.8 (18.), 332.8 (16.)
Trefferlage: 1.05 mm links, 1.10 mm tief
Streuwert: 3.99, horizontal: 5.30, vertikal: 1.91



Ergebnis: **186.5** (177)
 Serien: 93.5 93.0
 Zähler: 4 12 2 1 1 0 0 0 0 0 0
 Innenzehner: 3
 Weitester: 1026 (6.), 922 (16.), 547 (11.)
 beste Teiler: 50.9 (9.), 95.4 (5.), 111.8 (19.)
 Trefferlage: 1.73 mm links, 0.33 mm tief
 Streuwert: 3.17, horizontal: 4.20, vertikal: 1.54

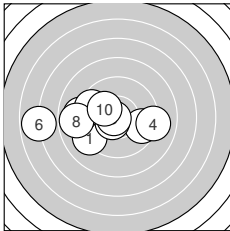
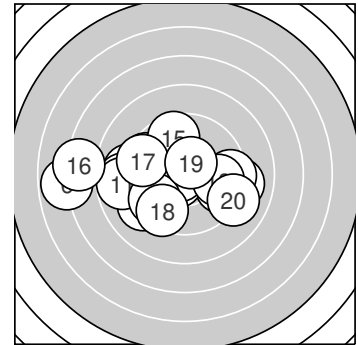

Serie 1: 93.5 (89)

9.2 ↙	9.0 ←	9.6 →	9.1 →	10.6* ↙
6.8 ←	9.5 ↖	8.8 ←	10.8* ←	10.1 ↖

beste Teiler: 50.9 (9.), 95.4 (5.), 202.1 (10.)
 Trefferlage: 2.24 mm links, 0.38 mm tief
 Streuwert: 3.14, horizontal: 4.28, vertikal: 1.15

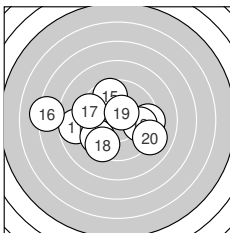

Serie 2: 93.0 (88)

8.8 ←	9.4 →	9.8 →	9.6 ↙	9.6 ↑
7.3 ←	9.4 ↖	9.5 ↙	10.5* ↑	9.1 ↘

beste Teiler: 111.8 (19.), 293.8 (13.), 332.7 (15.)
 Trefferlage: 1.23 mm links, 0.28 mm tief
 Streuwert: 3.32, horizontal: 4.29, vertikal: 1.91



Ergebnis: **0.0** (0)_{DNS}
Serien:
Zähler: 0 0 0 0 0 0 0 0 0 0 0
Innenzehner: 0
Weiteste:
~~beste Teiler~~Schütze ist nicht zum Wettkampf angetreten
Trefferlage: 0.00 mm , 0.00 mm
Streuwert:

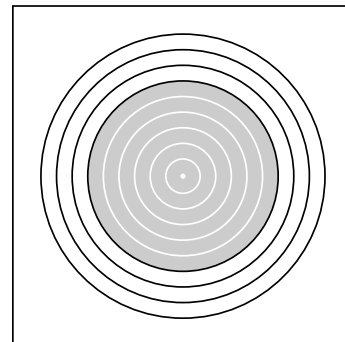

Ergebnis: **192.4** (181)
 Serien: 94.8 97.6
 Zähler: 6 9 5 0 0 0 0 0 0 0 0
 Innenezehner: 6
 Weitesten: 644 (11.), 578 (16.), 568 (2.)
 beste Teiler: 57.2 (13.), 71.0 (17.), 157.5 (4.)
 Trefferlage: 0.17 mm links, 0.79 mm hoch
 Streuwert: 2.65, horizontal: 3.42, vertikal: 1.53

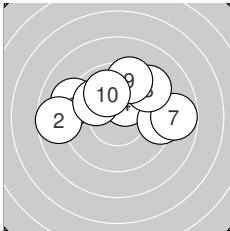
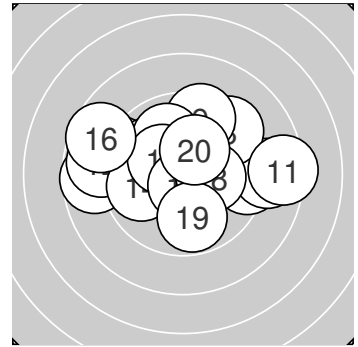

Serie 1: 94.8 (89)

9.2 ↖	8.7 ←	9.9 ↑	10.3* ↗	9.3 →
9.9 ↖	8.8 →	9.3 ↗	9.5 ↑	9.9 ↗

beste Teiler: 157.5 (4.), 251.4 (3.), 252.0 (10.)
 Trefferlage: 0.17 mm rechts, 1.48 mm hoch
 Streuwert: 2.67, horizontal: 3.53, vertikal: 1.34

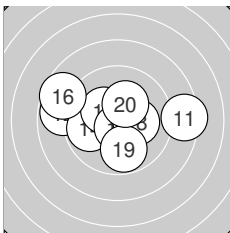

Serie 2: 97.6 (92)

8.4 →	8.8 ←	10.7* ↘	9.8 ←	10.3* ↖
8.6 ↖	10.7* ↓	10.2* →	9.8 ↓	10.3* ↗

beste Teiler: 57.2 (13.), 71.0 (17.), 162.6 (15.)
 Trefferlage: 0.52 mm links, 0.09 mm hoch
 Streuwert: 2.64, horizontal: 3.45, vertikal: 1.43



ÖSB LG 20 ZR

StandNr: 110

Zehentner,, Xaver #70311114

Juniors männlich

Wertung

StartNr: 56

02.03.2024 11:21

SG_Pillersee

Ergebnis: **0.0** (0)_{DNS}
Serien:
Zähler: 0 0 0 0 0 0 0 0 0 0 0
Innenzehner: 0
Weiteste:
~~beste Teiler~~Schütze ist nicht zum Wettkampf angetreten
Trefferlage: 0.00 mm , 0.00 mm
Streuwert:

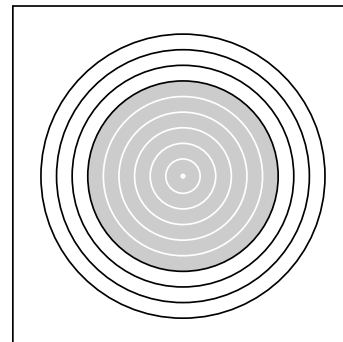

Ergebnis: **190.6** (184)
 Serien: 97.5 93.1
 Zähler: 11 4 3 2 0 0 0 0 0 0 0
 Innenzehner: 8
 Weitesten: 902 (12.), 810 (20.), 733 (1.)
 beste Teiler: 76.1 (4.), 131.2 (5.), 150.6 (17.)
 Trefferlage: 0.31 mm rechts, 0.83 mm tief
 Streuwert: 3.09, horizontal: 3.71, vertikal: 2.29

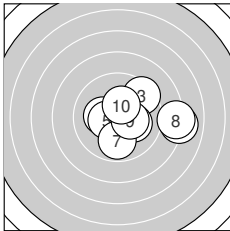
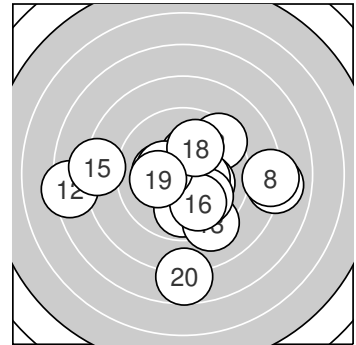

Serie 1: 97.5 (94)

8.0 → 10.2* ← 9.4 ↗ 10.6* → 10.4* ←
 10.2* → 9.9 ↓ 8.2 → 10.3* → 10.3* ↑
 beste Teiler: 76.1 (4.), 131.2 (5.), 151.2 (10.)
 Trefferlage: 1.84 mm rechts, 0.08 mm tief
 Streuwert: 2.40, horizontal: 3.10, vertikal: 1.40

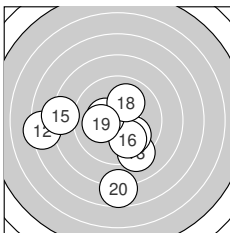

Serie 2: 93.1 (90)

10.3* ↘ 7.3 ← 9.2 ↘ 10.0 ↘ 8.2 ←
 9.9 ↘ 10.4* ← 10.0 ↗ 10.1 ← 7.7 ↓
 beste Teiler: 150.6 (17.), 161.9 (11.), 201.0 (19.)
 Trefferlage: 1.20 mm links, 1.58 mm tief
 Streuwert: 3.33, horizontal: 3.78, vertikal: 2.82



Ergebnis: **204.8** (194)
 Serien: 101.0 103.8
 Zähler: 14 6 0 0 0 0 0 0 0 0 0
 Innenzehner: 14
 Weitest: 411 (7.), 397 (5.), 356 (17.)
 beste Teiler: 13.0 (11.), 25.0 (13.), 38.4 (20.)
 Trefferlage: 0.35 mm links, 0.11 mm tief
 Streuwert: 1.54, horizontal: 1.77, vertikal: 1.27

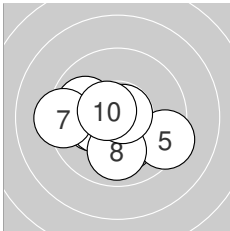
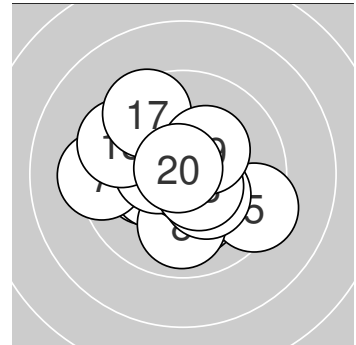

Serie 1: 101.0 (96)

10.2* ←	9.9 ↖	10.2* ↓	10.3* ↓	9.4 →
10.4* ←	9.3 ←	9.9 ↓	10.8* ↗	10.6* ↖

beste Teiler: 47.1 (9.), 94.6 (10.), 149.2 (6.)
 Trefferlage: 0.51 mm links, 0.67 mm tief
 Streuwert: 1.70, horizontal: 2.13, vertikal: 1.13

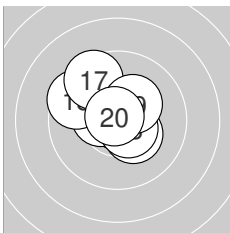

Serie 2: 103.8 (98)

10.9* ↘	10.4* ←	10.9* →	10.6* →	9.6 ↖
10.3* ↘	9.5 ↖	10.5* ↘	10.3* ↗	10.8* ↖

beste Teiler: 13.0 (11.), 25.0 (13.), 38.4 (20.)
 Trefferlage: 0.20 mm links, 0.45 mm hoch
 Streuwert: 1.32, horizontal: 1.43, vertikal: 1.20



Ergebnis: **180.7** (173)
 Serien: 91.7 89.0
 Zähler: 5 8 4 1 2 0 0 0 0 0 0
 Innenzehner: 3
 Weitestе: 1214 (8.), 1163 (18.), 939 (20.)
 beste Teiler: 108.7 (2.), 120.7 (17.), 162.6 (9.)
 Trefferlage: 1.75 mm links, 1.10 mm tief
 Streuwert: 3.85, horizontal: 4.77, vertikal: 2.63

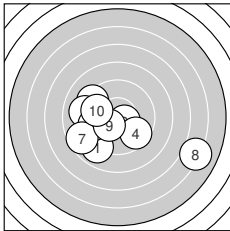
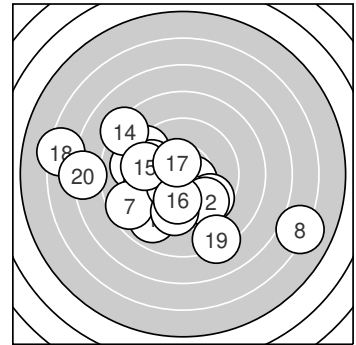

Serie 1: 91.7 (87)

8.9 ↙	10.5* ↘	9.3 ↗	9.6 ↘	9.1 ←
9.6 ←	8.6 ↙	6.1 ↘	10.3* ↙	9.7 ↖

beste Teiler: 108.7 (2.), 162.6 (9.), 307.6 (10.)
 Trefferlage: 0.88 mm links, 1.31 mm tief
 Streuwert: 3.78, horizontal: 4.80, vertikal: 2.36

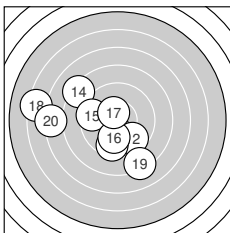

Serie 2: 89.0 (86)

10.0 ↓	9.6 ↘	9.5 ↓	8.2 ↗	9.5 ←
10.0 ↓	10.5* ↖	6.3 ←	8.2 ↘	7.2 ←

beste Teiler: 120.7 (17.), 229.2 (11.), 246.3 (16.)
 Trefferlage: 2.61 mm links, 0.90 mm tief
 Streuwert: 4.02, horizontal: 4.83, vertikal: 3.00



Ergebnis: **193.2** (187)
 Serien: 97.8 95.4
 Zähler: 12 3 5 0 0 0 0 0 0 0
 Innenzehner: 8
 Weitester: 747 (18.), 654 (7.), 632 (2.)
 beste Teiler: 70.2 (5.), 77.7 (1.), 110.0 (3.)
 Trefferlage: 0.52 mm links, 0.41 mm tief
 Streuwert: 2.73, horizontal: 3.56, vertikal: 1.51

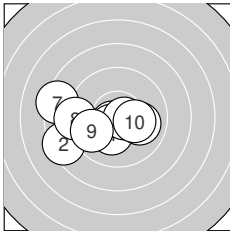
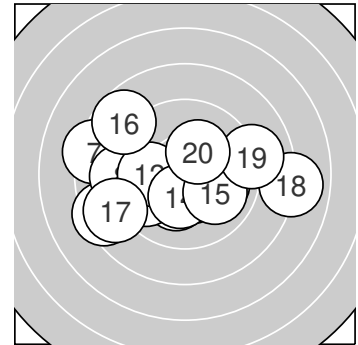

Serie 1: 97.8 (94)

10.6* ↙	8.4 ↙	10.5* ↙	10.2* ↓	10.7* →
10.0 →	8.3 ↖	9.2 ←	9.7 ↙	10.2* →

beste Teiler: 70.2 (5.), 77.7 (1.), 110.0 (3.)
 Trefferlage: 1.62 mm links, 0.71 mm tief
 Streuwert: 2.30, horizontal: 3.05, vertikal: 1.15

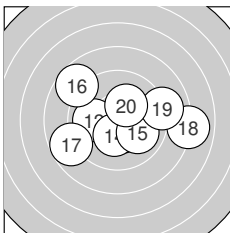

Serie 2: 95.4 (93)

10.1 →	10.0 ←	10.4* ↓	10.3* ↓	10.0 ↘
8.7 ↘	8.7 ↙	8.0 →	9.0 →	10.2* ↗

beste Teiler: 131.5 (13.), 159.6 (14.), 180.0 (20.)
 Trefferlage: 0.57 mm rechts, 0.12 mm tief
 Streuwert: 3.00, horizontal: 3.84, vertikal: 1.82



Ergebnis: **203.6** (194)
 Serien: 102.4 101.2
 Zähler: 15 4 1 0 0 0 0 0 0 0
 Innenzehner: 11
 Weitestе: 573 (14.), 372 (10.), 322 (11.)
 beste Teiler: 43.1 (3.), 62.1 (4.), 62.2 (13.)
 Trefferlage: 0.37 mm rechts, 0.36 mm hoch
 Streuwert: 1.65, horizontal: 2.05, vertikal: 1.12

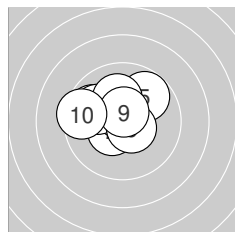
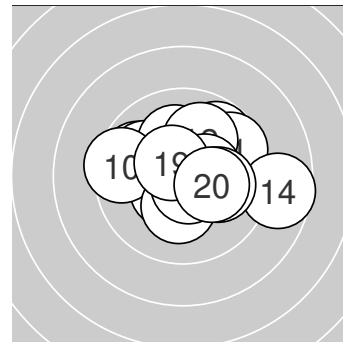

Serie 1: 102.4 (97)

9.8 ↖	10.5* ↙	10.8* ↗	10.7* ↑	9.8 ↗
10.0 ↖	10.1 ↑	10.6* ↘	10.6* ↑	9.5 ←

beste Teiler: 43.1 (3.), 62.1 (4.), 83.7 (9.)
 Trefferlage: 0.69 mm links, 0.73 mm hoch
 Streuwert: 1.39, horizontal: 1.72, vertikal: 0.97

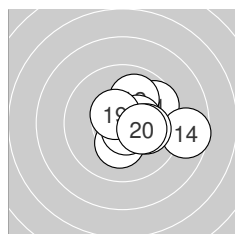

Serie 2: 101.2 (97)

9.7 ↗	10.0 ↑	10.7* ↘	8.7 →	10.2* ↓
10.4* →	10.7* ↘	10.1 →	10.5* ↖	10.2* →

beste Teiler: 62.2 (13.), 68.4 (17.), 103.5 (19.)
 Trefferlage: 1.44 mm rechts, 0.00 mm
 Streuwert: 1.55, horizontal: 1.83, vertikal: 1.20



ÖSB LG 20 ZR

StandNr: 116

Zint,, Niklas #70222081

Juniors männlich

Wertung

StartNr: 62

02.03.2024 11:21

SG_Oberperfuß

Ergebnis: **0.0** (0)_{DNS}
Serien:
Zähler: 0 0 0 0 0 0 0 0 0 0 0
Innenzehner: 0
Weiteste:
~~beste Teiler~~Schütze ist nicht zum Wettkampf angetreten
Trefferlage: 0.00 mm , 0.00 mm
Streuwert:

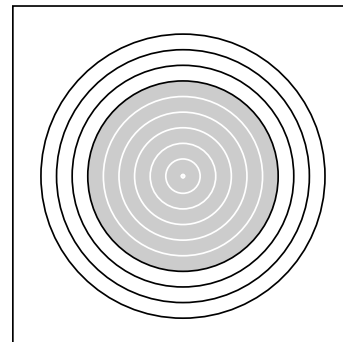

Ergebnis: **195.1** (186)
 Serien: 95.7 99.4
 Zähler: 9 8 3 0 0 0 0 0 0 0 0
 Innenzehner: 6
 Weitester: 607 (20.), 523 (10.), 522 (8.)
 beste Teiler: 63.4 (13.), 89.0 (5.), 99.6 (14.)
 Trefferlage: 0.20 mm links, 0.26 mm hoch
 Streuwert: 2.48, horizontal: 3.26, vertikal: 1.31

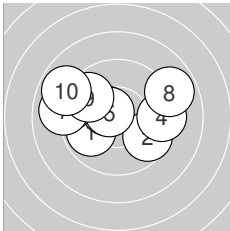
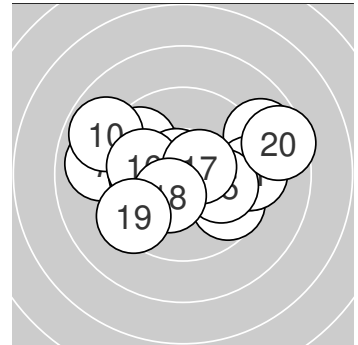

Serie 1: 95.7 (90)

9.9 ↙	9.7 ↘	10.5* ↖	9.4 →	10.6* ↖
9.1 ←	9.0 ←	8.9 →	9.7 ↖	8.9 ↖

beste Teiler: 89.0 (5.), 115.1 (3.), 272.8 (1.)
 Trefferlage: 0.93 mm links, 0.62 mm hoch
 Streuwert: 2.72, horizontal: 3.60, vertikal: 1.38

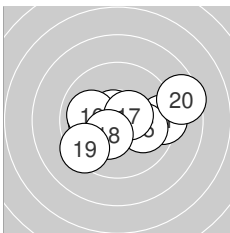

Serie 2: 99.4 (96)

9.3 →	10.1 ←	10.7* ↘	10.6* →	10.0 →
10.0 ←	10.5* →	10.3* ↙	9.4 ↙	8.5 →

beste Teiler: 63.4 (13.), 99.6 (14.), 108.3 (17.)
 Trefferlage: 0.52 mm rechts, 0.08 mm tief
 Streuwert: 2.21, horizontal: 2.88, vertikal: 1.19



Ergebnis: **186.8** (177)
 Serien: 92.0 94.8
 Zähler: 6 8 3 3 0 0 0 0 0 0 0
 Innenezehner: 4
 Weitestе: 889 (11.), 777 (8.), 777 (9.)
 beste Teiler: 50.4 (12.), 79.1 (15.), 81.0 (10.)
 Trefferlage: 0.73 mm rechts, 1.18 mm hoch
 Streuwert: 3.28, horizontal: 4.31, vertikal: 1.71

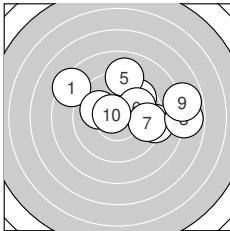
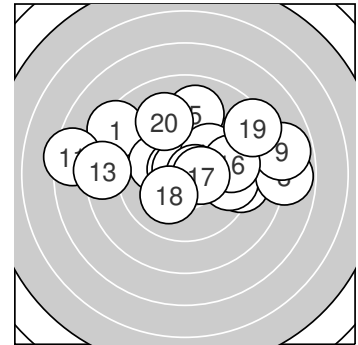

Serie 1: 92.0 (87)

8.4 ↖	9.2 →	9.7 ↗	10.0 ↖	9.1 ↑
9.9 ↗	9.5 →	7.8 →	7.8 →	10.6* ↖

beste Teiler: 81.0 (10.), 233.4 (4.), 254.1 (6.)
 Trefferlage: 2.02 mm rechts, 1.31 mm hoch
 Streuwert: 3.18, horizontal: 4.13, vertikal: 1.77

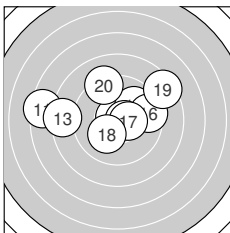

Serie 2: 94.8 (90)

7.4 ←	10.8* ↖	8.4 ←	9.9 ↗	10.6* →
9.5 →	10.5* →	10.1 ↘	8.4 ↗	9.2 ↑

beste Teiler: 50.4 (12.), 79.1 (15.), 125.3 (17.)
 Trefferlage: 0.55 mm links, 1.06 mm hoch
 Streuwert: 3.28, horizontal: 4.31, vertikal: 1.73



Ergebnis: **0.0** (0)_{DNS}
Serien:
Zähler: 0 0 0 0 0 0 0 0 0 0 0
Innenzehner: 0
Weiteste:
~~beste Teiler~~
Trefferlage: 0.00 mm , 0.00 mm
Streuwert:

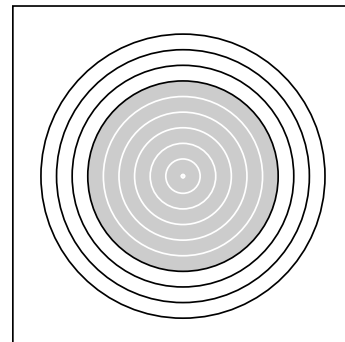

Ergebnis: **193.8** (184)
 Serien: 95.4 98.4
 Zähler: 8 9 2 1 0 0 0 0 0 0 0
 Innenzehner: 7
 Weitester: 779 (2.), 615 (19.), 506 (9.)
 beste Teiler: 67.7 (18.), 103.7 (11.), 127.4 (14.)
 Trefferlage: 0.84 mm rechts, 0.71 mm hoch
 Streuwert: 2.52, horizontal: 3.15, vertikal: 1.66

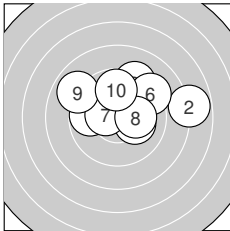
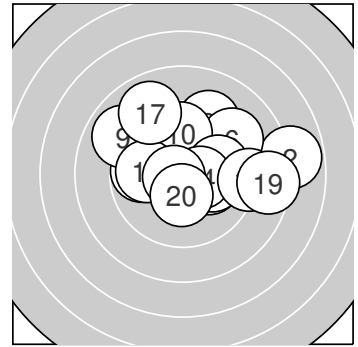

Serie 1: 95.4 (90)

9.8 ←	7.8 →	9.3 ↗	9.8 ←	10.2* →
9.2 ↗	10.4* ←	10.2* →	8.9 ↘	9.8 ↑

beste Teiler: 129.6 (7.), 195.0 (8.), 197.3 (5.)
 Trefferlage: 0.55 mm rechts, 1.35 mm hoch
 Streuwert: 2.74, horizontal: 3.58, vertikal: 1.50

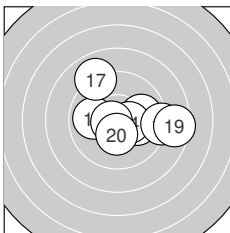

Serie 2: 98.4 (94)

10.5* ↓	10.1 →	9.9 →	10.4* →	9.9 ←
9.1 →	9.0 ↖	10.7* ←	8.5 →	10.3* ↓

beste Teiler: 67.7 (18.), 103.7 (11.), 127.4 (14.)
 Trefferlage: 1.13 mm rechts, 0.07 mm hoch
 Streuwert: 2.31, horizontal: 2.83, vertikal: 1.62



Ergebnis: **197.0** (190)
 Serien: 97.8 99.2
 Zähler: 10 10 0 0 0 0 0 0 0 0
 Innenzehner: 6
 Weitester: 489 (9.), 475 (2.), 439 (18.)
 beste Teiler: 62.5 (14.), 108.4 (5.), 111.6 (4.)
 Trefferlage: 0.68 mm rechts, 0.43 mm hoch
 Streuwert: 2.14, horizontal: 2.66, vertikal: 1.45

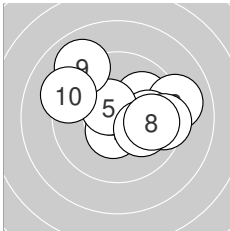
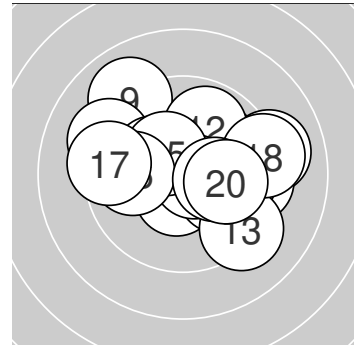

Serie 1: 97.8 (95)

10.0 ↗ 9.1 → 10.0 →
 9.5 → 10.1 ↘ 9.9 →
 beste Teiler: 108.4 (5.), 111.6 (4.), 212.4 (7.)
 Trefferlage: 0.95 mm rechts, 0.64 mm hoch
 Streuwert: 2.26, horizontal: 2.81, vertikal: 1.54

10.5* ↓ 10.5* ↖
 9.0 ↘ 9.2 ↖

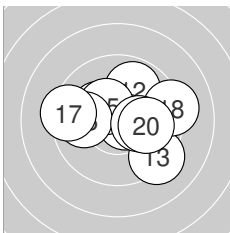

Serie 2: 99.2 (95)

10.2* ↖ 9.9 ↗ 9.2 ↘
 9.9 ← 9.4 ← 9.2 →
 beste Teiler: 62.5 (14.), 142.7 (15.), 172.2 (19.)
 Trefferlage: 0.41 mm rechts, 0.22 mm hoch
 Streuwert: 2.11, horizontal: 2.63, vertikal: 1.39

10.7* → 10.4* ↖
 10.3* → 10.0 →



Ergebnis: **194.5** (187)
 Serien: 98.1 96.4
 Zähler: 10 7 3 0 0 0 0 0 0 0
 Innenzehner: 7
 Weitestе: 691 (14.), 660 (16.), 518 (3.)
 beste Teiler: 68.8 (8.), 111.2 (18.), 153.3 (4.)
 Trefferlage: 0.17 mm links, 1.48 mm hoch
 Streuwert: 2.30, horizontal: 2.85, vertikal: 1.57

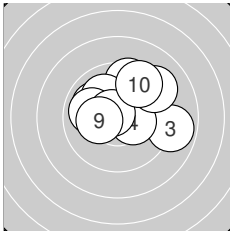
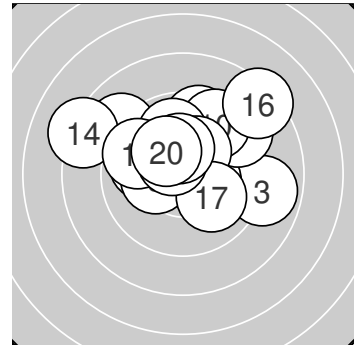

Serie 1: 98.1 (94)

9.5 ↑	10.0 ↘	8.9 →	10.3* →	10.0 ↘
9.9 ←	9.2 ↗	10.7* ↘	10.2* ←	9.4 ↗

beste Teiler: 68.8 (8.), 153.3 (4.), 177.3 (9.)
 Trefferlage: 0.49 mm rechts, 1.16 mm hoch
 Streuwert: 2.13, horizontal: 2.56, vertikal: 1.58

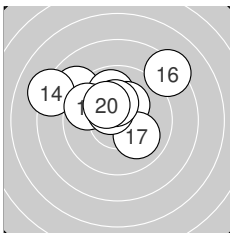

Serie 2: 96.4 (93)

9.0 ↘	9.9 ↑	10.3* ↗	8.2 ↘	9.7 ↘
8.3 ↗	10.0 ↘	10.5* ↘	10.3* ↑	10.2* ↘

beste Teiler: 111.2 (18.), 165.6 (19.), 169.8 (13.)
 Trefferlage: 0.83 mm links, 1.80 mm hoch
 Streuwert: 2.46, horizontal: 3.11, vertikal: 1.56



Ergebnis: **189.5** (182)
 Serien: 95.1 94.4
 Zähler: 7 8 5 0 0 0 0 0 0 0 0
 Innenzehner: 5
 Weitestе: 680 (2.), 662 (17.), 630 (20.)
 beste Teiler: 56.5 (9.), 144.3 (15.), 175.6 (11.)
 Trefferlage: 1.24 mm links, 0.06 mm tief
 Streuwert: 2.84, horizontal: 3.48, vertikal: 2.01

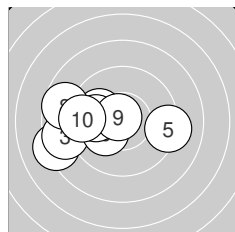
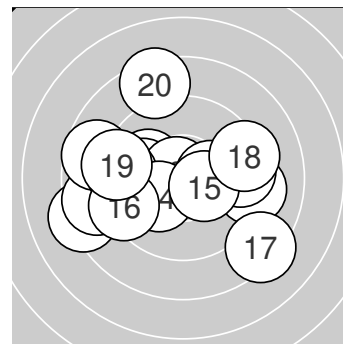

Serie 1: 95.1 (91)

10.1 ↖	8.2 ↙	8.7 ↙	10.0 ↖	9.2 →
10.2* ↙	9.9 ↙	8.7 ↙	10.7* ↖	9.4 ↖

beste Teiler: 56.5 (9.), 193.8 (6.), 218.2 (1.)
 Trefferlage: 2.57 mm links, 0.17 mm tief
 Streuwert: 2.36, horizontal: 3.11, vertikal: 1.20

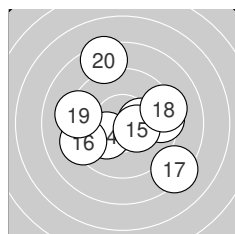

Serie 2: 94.4 (91)

10.3* →	9.5 ↙	9.5 →	10.2* ↙	10.4* ↘
9.3 ↙	8.3 ↘	9.3 →	9.2 ↖	8.4 ↑

beste Teiler: 144.3 (15.), 175.6 (11.), 191.8 (14.)
 Trefferlage: 0.07 mm rechts, 0.04 mm hoch
 Streuwert: 3.09, horizontal: 3.47, vertikal: 2.66



Ergebnis: **184.5** (171)
 Serien: 90.1 94.4
 Zähler: 2 9 7 2 0 0 0 0 0 0
 Innenzehner: 2
 Weitestе: 944 (10.), 868 (17.), 585 (13.)
 beste Teiler: 44.6 (15.), 56.8 (18.), 281.1 (19.)
 Trefferlage: 1.97 mm links, 2.20 mm hoch
 Streuwert: 2.79, horizontal: 3.40, vertikal: 2.00

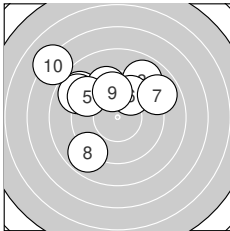
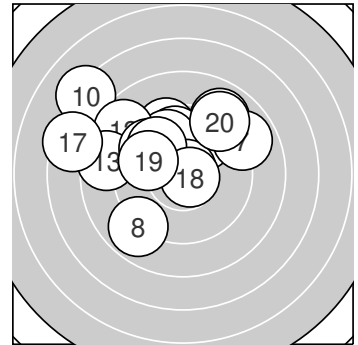

Serie 1: 90.1 (83)

8.9 ↘	9.5 ↗	8.9 ↗
9.8 ↗	8.9 ↗	8.9 ↘

8.9 ↘	9.3 ↘
9.8 ↗	7.2 ↘

beste Teiler: 288.2 (6.), 294.1 (9.), 372.3 (2.)
 Trefferlage: 1.60 mm links, 2.55 mm hoch
 Streuwert: 3.16, horizontal: 3.68, vertikal: 2.54

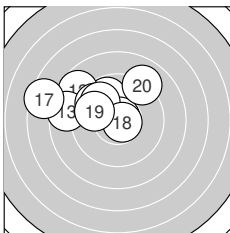

Serie 2: 94.4 (88)

9.8 ↘	8.7 ↘	8.6 ←
9.8 ↘	7.5 ←	10.7* →

9.7 ↘	10.8* ↗
9.8 ↘	9.0 ↗

beste Teiler: 44.6 (15.), 56.8 (18.), 281.1 (19.)
 Trefferlage: 2.34 mm links, 1.86 mm hoch
 Streuwert: 2.48, horizontal: 3.25, vertikal: 1.32



Ergebnis: **197.1** (187)
 Serien: 98.3 98.8
 Zähler: 10 7 3 0 0 0 0 0 0 0
 Innenzehner: 7
 Weitester: 725 (20.), 556 (3.), 516 (1.)
 beste Teiler: 50.9 (6.), 62.0 (14.), 79.6 (8.)
 Trefferlage: 0.08 mm links, 0.95 mm hoch
 Streuwert: 2.26, horizontal: 2.89, vertikal: 1.36

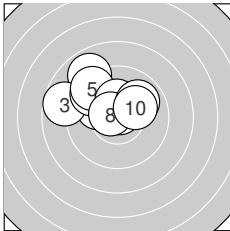
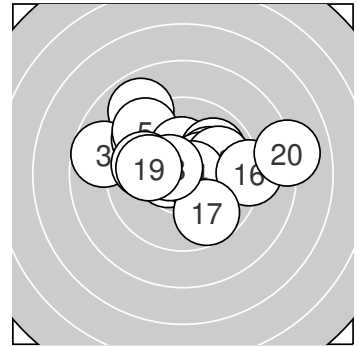

Serie 1: 98.3 (93)

8.9 ↖ 10.1 ↖ 8.7 ← 9.5 ↖ 9.4 ↖
 10.8* ↗ 10.3* ↑ 10.6* ↖ 9.9 ↗ 10.1 ↗
 beste Teiler: 50.9 (6.), 79.6 (8.), 166.2 (7.)
 Trefferlage: 1.22 mm links, 1.70 mm hoch
 Streuwert: 1.85, horizontal: 2.31, vertikal: 1.22

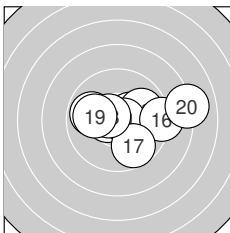

Serie 2: 98.8 (94)

10.4* ↗ 10.5* ← 9.9 → 10.7* → 9.9 ←
 9.1 → 9.7 ↘ 10.5* ↖ 10.0 ← 8.1 →
 beste Teiler: 62.0 (14.), 101.0 (18.), 102.0 (12.)
 Trefferlage: 1.06 mm rechts, 0.20 mm hoch
 Streuwert: 2.30, horizontal: 3.06, vertikal: 1.09



Ergebnis: **203.3** (195)
 Serien: 102.6 100.7
 Zähler: 15 5 0 0 0 0 0 0 0 0
 Innenzehner: 11
 Weitestе: 416 (14.), 380 (16.), 376 (6.)
 beste Teiler: 5.0 (7.), 57.0 (15.), 92.0 (11.)
 Trefferlage: 0.42 mm links, 0.14 mm hoch
 Streuwert: 1.59, horizontal: 2.10, vertikal: 0.78

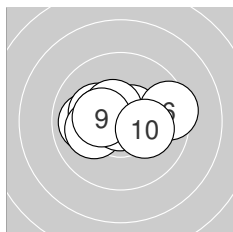
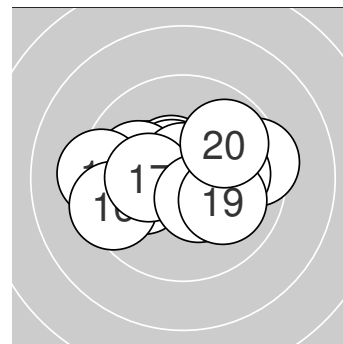

Serie 1: 102.6 (98)

9.9 ←	10.2* ↖	10.4* ←	10.6* ↗	10.1 ←
9.4 →	10.9* ←	10.5* ↖	10.4* ←	10.2* →

beste Teiler: 5.0 (7.), 95.9 (4.), 111.5 (8.)
 Trefferlage: 0.33 mm links, 0.23 mm hoch
 Streuwert: 1.43, horizontal: 1.95, vertikal: 0.54

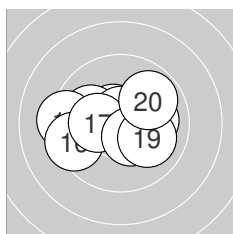

Serie 2: 100.7 (97)

10.6* ↘	10.1 →	10.0 ←	9.3 ←	10.7* ↑
9.4 ←	10.3* ←	10.4* ↘	10.0 →	9.9 ↗

beste Teiler: 57.0 (15.), 92.0 (11.), 129.0 (18.)
 Trefferlage: 0.51 mm links, 0.06 mm hoch
 Streuwert: 1.80, horizontal: 2.35, vertikal: 0.98



Ergebnis: **177.2** (170)
 Serien: 86.0 91.2
 Zähler: 2 9 7 1 1 0 0 0 0 0 0
 Innenzehner: 2
 Weitester: 1008 (4.), 973 (10.), 713 (19.)
 beste Teiler: 51.6 (1.), 140.3 (5.), 281.4 (16.)
 Trefferlage: 0.26 mm links, 1.06 mm tief
 Streuwert: 4.09, horizontal: 5.38, vertikal: 2.11

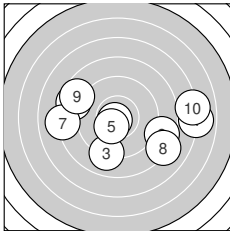
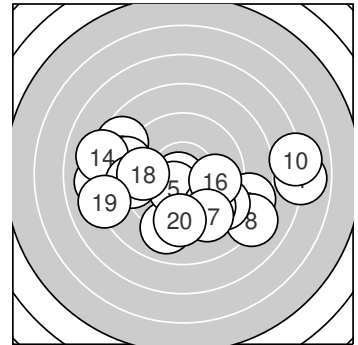

Serie 1: 86.0 (82)

10.7* ↙ 8.5 ↘ 9.0 ↓ 6.9 → 10.4* ↙
 8.6 ← 8.1 ← 8.1 ↘ 8.6 ← 7.1 →
 beste Teiler: 51.6 (1.), 140.3 (5.), 478.5 (3.)
 Trefferlage: 1.07 mm rechts, 0.73 mm tief
 Streuwert: 4.79, horizontal: 6.34, vertikal: 2.36

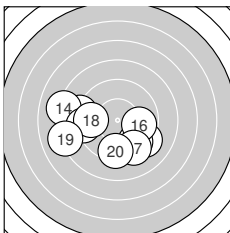

Serie 2: 91.2 (88)

9.2 ↘ 9.5 ↘ 9.0 ← 8.1 ← 9.2 ←
 9.8 → 9.3 ↘ 9.6 ← 8.1 ← 9.4 ↓
 beste Teiler: 281.4 (16.), 342.0 (18.), 357.3 (12.)
 Trefferlage: 1.59 mm links, 1.38 mm tief
 Streuwert: 3.20, horizontal: 4.10, vertikal: 1.91



Ergebnis: **186.9** (180)
 Serien: 93.2 93.7
 Zähler: 6 9 4 1 0 0 0 0 0 0 0
 Innenzehner: 2
 Weitesten: 988 (1.), 750 (17.), 637 (19.)
 beste Teiler: 181.1 (20.), 185.4 (11.), 233.8 (9.)
 Trefferlage: 0.05 mm links, 0.27 mm hoch
 Streuwert: 3.25, horizontal: 4.08, vertikal: 2.11

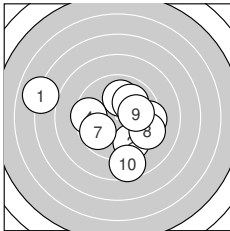
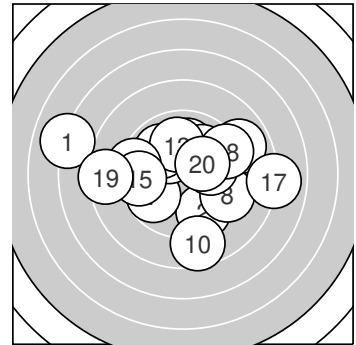

Serie 1: 93.2 (90)

7.0 ← 9.6 ↘ 10.0 ↑ 9.5 ← 9.4 →
 10.0 ↗ 9.8 ↙ 9.3 ↘ 10.0 → 8.6 ↓
 beste Teiler: 233.8 (9.), 237.8 (3.), 241.7 (6.)
 Trefferlage: 0.09 mm links, 0.48 mm tief
 Streuwert: 3.42, horizontal: 4.07, vertikal: 2.63

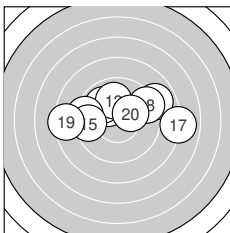

Serie 2: 93.7 (90)

10.2* ↘ 9.9 ↘ 10.0 ↑ 9.3 ← 9.5 ←
 8.9 ↗ 8.0 → 9.3 ↗ 8.4 ← 10.2* ↗
 beste Teiler: 181.1 (20.), 185.4 (11.), 247.8 (13.)
 Trefferlage: 0.01 mm links, 1.03 mm hoch
 Streuwert: 3.15, horizontal: 4.31, vertikal: 1.12



Ergebnis: **197.9** (189)
 Serien: 100.7 97.2
 Zähler: 13 5 1 0 1 0 0 0 0 0
 Innenzehner: 8
 Weitestе: 1037 (16.), 538 (12.), 376 (1.)
 beste Teiler: 27.0 (20.), 40.8 (15.), 102.5 (8.)
 Trefferlage: 0.10 mm rechts, 0.25 mm hoch
 Streuwert: 2.45, horizontal: 3.04, vertikal: 1.66

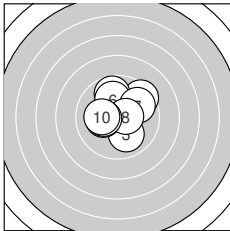
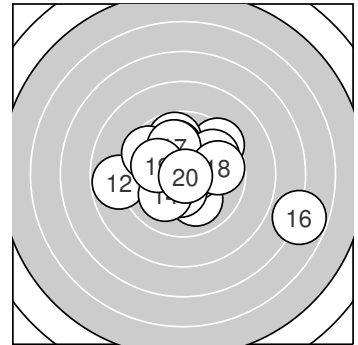

Serie 1: 100.7 (97)

9.4 ↗ 9.8 ↑ 10.0 ↘
 10.0 ↑ 9.8 ↗ 10.5* →
 beste Teiler: 102.5 (8.), 118.2 (4.), 174.5 (9.)
 Trefferlage: 0.17 mm rechts, 0.71 mm hoch
 Streuwert: 1.66, horizontal: 1.78, vertikal: 1.54

10.5* → 10.2* ←
 10.3* ← 10.2* ←

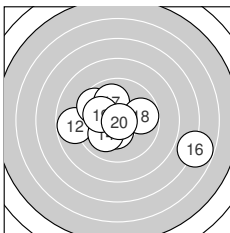

Serie 2: 97.2 (92)

10.4* ↓ 8.8 ← 9.6 ↘
 6.8 → 10.0 ↑ 9.8 →
 beste Teiler: 27.0 (20.), 40.8 (15.), 137.9 (11.)
 Trefferlage: 0.04 mm rechts, 0.20 mm tief
 Streuwert: 3.11, horizontal: 4.04, vertikal: 1.73

10.1 ↙ 10.8* →
 10.1 ← 10.8* ↘

