

Ergebnis: **416.6** (397)
 Serien: 102.8 104.1 104.8 104.9
 Zähler: 37 3 0 0 0 0 0 0 0 0
 Innenzehner: 31
 Weitestе: 283 (9.), 275 (1.), 259 (29.)
 beste Teiler: 35.6 (15.), 37.8 (21.), 47.2 (25.)
 Trefferlage: 0.28 mm links, 0.05 mm hoch
 Streuwert: 1.06, horizontal: 1.02, vertikal: 1.10

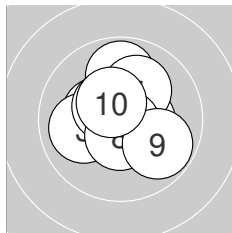
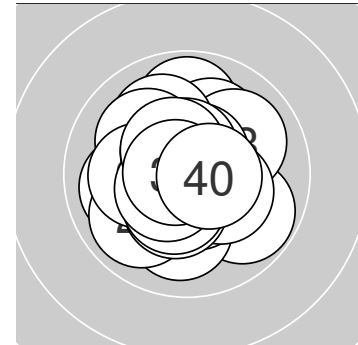

Serie 1: 102.8 (98)

9.9 ↑	10.3* ←	10.0 ←	10.4* →	10.1 ↗
10.8* ↘	10.5* ↘	10.5* ↓	9.8 ↘	10.5* ↘

beste Teiler: 50.4 (6.), 102.1 (8.), 119.5 (7.)
 Trefferlage: 0.03 mm links, 0.32 mm hoch
 Streuwert: 1.35, horizontal: 1.38, vertikal: 1.33

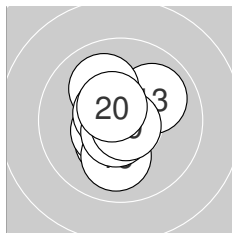

Serie 2: 104.1 (100)

10.3* ↙	10.5* ↙	10.0 ↗	10.0 ↘	10.8* ←
10.0 ↓	10.6* ↘	10.6* ↓	10.8* ↘	10.5* ↘

beste Teiler: 35.6 (15.), 48.0 (19.), 79.8 (18.)
 Trefferlage: 0.26 mm links, 0.06 mm tief
 Streuwert: 1.11, horizontal: 0.89, vertikal: 1.29

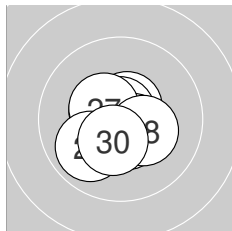

Serie 3: 104.8 (99)

10.8* ←	10.5* ↘	10.6* ↗	10.5* ↓	10.8* ↑
10.6* ↘	10.4* ↘	10.3* ↘	9.9 ↙	10.4* ↓

beste Teiler: 37.8 (21.), 47.2 (25.), 89.0 (23.)
 Trefferlage: 0.19 mm links, 0.29 mm tief
 Streuwert: 0.95, horizontal: 1.00, vertikal: 0.91

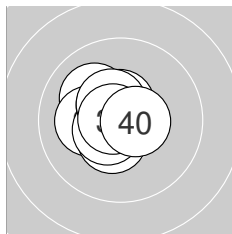

Serie 4: 104.9 (100)

10.6* ↑	10.7* ←	10.1 ↘	10.2* ←	10.4* ↓
10.5* ↘	10.5* ↙	10.5* ↘	10.8* ←	10.6* →

beste Teiler: 49.4 (39.), 62.1 (32.), 95.4 (40.)
 Trefferlage: 0.64 mm links, 0.24 mm hoch
 Streuwert: 0.81, horizontal: 0.80, vertikal: 0.82



Ergebnis: 415.3 (396)
Serien: 101.4 103.9 105.8 104.2
Zähler: 36 4 0 0 0 0 0 0 0 0
Innenzehner: 31
Weiteste: 391 (2.), 315 (10.), 279 (35.)
beste Teiler: 40.6 (25.), 42.9 (17.), 47.3 (21.)
Trefferlage: 0.08 mm rechts, 0.03 mm hoch
Streuwert: 1.16, horizontal: 1.14, vertikal: 1.18

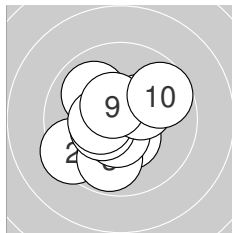
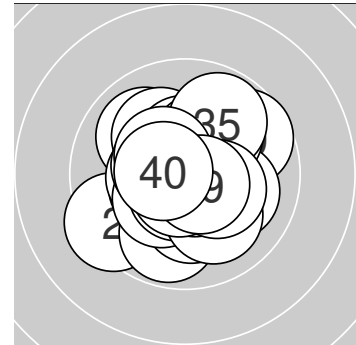

Serie 1: 101.4 (97)

10.4* ↓	9.4 ↙	9.8 ↓	10.5* ↓	10.0 ↘
10.4* ↙	10.4* ←	10.3* ↗	10.5* ↘	9.7 ↗

beste Teiler: 106.5 (4.), 108.7 (9.), 131.3 (1.)
Trefferlage: 0.45 mm links, 0.26 mm tief
Streuwert: 1.61, horizontal: 1.68, vertikal: 1.54

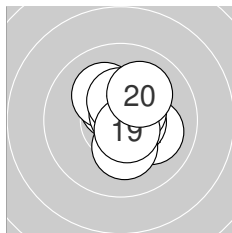

Serie 2: 103.9 (100)

10.1 →	10.5* ↘	10.6* →	10.1 ↘	10.2* ↓
10.5* ↗	10.8* ↑	10.4* ↑	10.6* ↓	10.1 ↗

beste Teiler: 42.9 (17.), 79.3 (19.), 88.9 (13.)
Trefferlage: 0.42 mm rechts, 0.34 mm hoch
Streuwert: 1.05, horizontal: 0.91, vertikal: 1.18

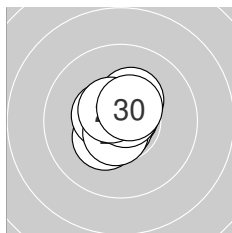

Serie 3: 105.8 (100)

10.8* ↗	10.3* ↙	10.3* ↗	10.5* ↖	10.8* ↓
10.8* ↑	10.6* ↓	10.7* ↗	10.5* ↘	10.5* ↗

beste Teiler: 40.6 (25.), 47.3 (21.), 47.3 (26.)
Trefferlage: 0.12 mm links, 0.24 mm hoch
Streuwert: 0.72, horizontal: 0.66, vertikal: 0.78

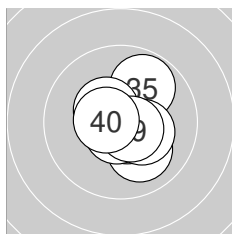

Serie 4: 104.2 (99)

10.3* ↓	10.1 ↓	10.7* ↗	10.7* ↓	9.8 ↗
10.4* ↘	10.7* ↓	10.3* ↘	10.6* ↓	10.6* ←

beste Teiler: 65.9 (37.), 71.5 (33.), 75.0 (34.)
Trefferlage: 0.47 mm rechts, 0.16 mm tief
Streuwert: 1.07, horizontal: 0.93, vertikal: 1.19



Ergebnis: **413.1** (391)
 Serien: 103.1 103.0 103.8 103.2
 Zähler: 31 9 0 0 0 0 0 0 0 0
 Innenzehner: 27
 Weitestе: 359 (32.), 308 (40.), 277 (12.)
 beste Teiler: 27.0 (36.), 44.7 (38.), 53.0 (28.)
 Trefferlage: 0.13 mm links, 0.03 mm hoch
 Streuwert: 1.25, horizontal: 1.32, vertikal: 1.18

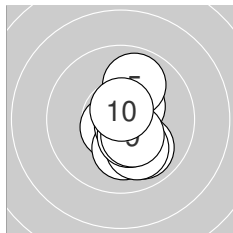
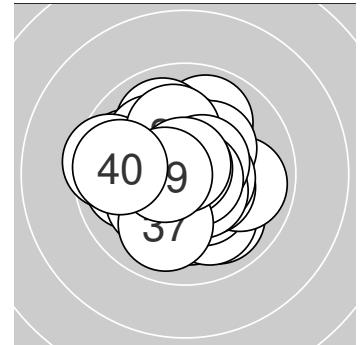

Serie 1: 103.1 (98)

10.6* ↙	10.1 ↓	10.7* ↘	10.4* ↗	9.9 ↑
9.9 ↘	10.0 ↘	10.4* ↘	10.4* ↘	10.7* ↑

beste Teiler: 60.3 (3.), 69.3 (10.), 84.2 (1.)
 Trefferlage: 0.60 mm rechts, 0.53 mm tief
 Streuwert: 1.14, horizontal: 0.62, vertikal: 1.49

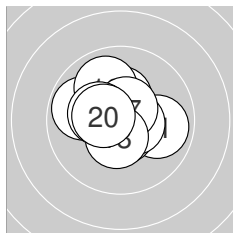

Serie 2: 103.0 (97)

9.9 →	9.8 ←	10.6* ↓	10.6* →	10.3* ↑
9.9 ↑	10.6* ↑	10.5* ↓	10.3* ←	10.5* ←

beste Teiler: 86.6 (13.), 91.7 (17.), 92.8 (14.)
 Trefferlage: 0.26 mm links, 0.36 mm hoch
 Streuwert: 1.28, horizontal: 1.45, vertikal: 1.08

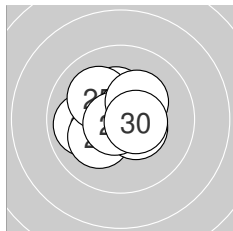

Serie 3: 103.8 (99)

10.5* ↗	10.4* ↑	9.9 ←	10.2* ↙	10.1 ↘
10.5* ↘	10.7* ↗	10.7* ↙	10.3* ↗	10.5* →

beste Teiler: 53.0 (28.), 57.2 (27.), 109.8 (30.)
 Trefferlage: 0.16 mm links, 0.24 mm hoch
 Streuwert: 1.15, horizontal: 1.33, vertikal: 0.95

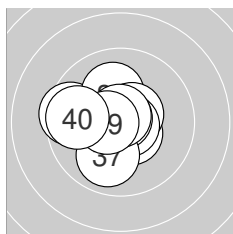

Serie 4: 103.2 (97)

10.5* ↘	9.5 ←	10.1 ↑	10.6* ↗	10.7* ↘
10.8* ↑	9.9 ↓	10.8* ↑	10.6* ←	9.7 ←

beste Teiler: 27.0 (36.), 44.7 (38.), 55.5 (35.)
 Trefferlage: 0.70 mm links, 0.08 mm hoch
 Streuwert: 1.33, horizontal: 1.51, vertikal: 1.11



Ergebnis: **418.3** (400)
 Serien: 103.7 106.3 103.8 104.5
 Zähler: 40 0 0 0 0 0 0 0 0 0
 Innenzehner: 33
 Weitestе: 242 (8.), 228 (22.), 228 (35.)
 beste Teiler: 37.6 (21.), 39.0 (14.), 41.7 (19.)
 Trefferlage: 0.00 mm , 0.01 mm tief
 Streuwert: 1.00, horizontal: 0.85, vertikal: 1.13

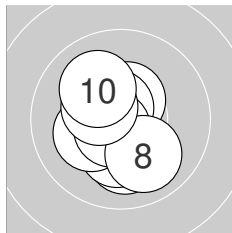
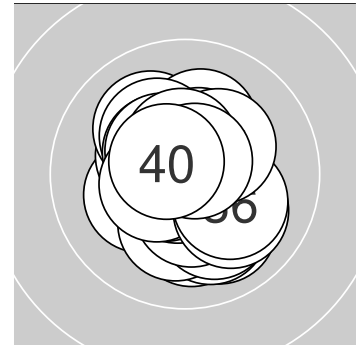

Serie 1: 103.7 (100)

10.5* ↑	10.1 ↓	10.7* ←	10.3* ↓	10.2* ←
10.7* ↘	10.7* ↗	10.0 ↘	10.4* ↖	10.1 ↘

beste Teiler: 64.6 (3.), 72.9 (6.), 74.3 (7.)
 Trefferlage: 0.39 mm links, 0.30 mm tief
 Streuwert: 1.17, horizontal: 0.91, vertikal: 1.38

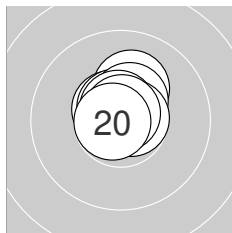

Serie 2: 106.3 (100)

10.2* ↑	10.6* ↘	10.6* ↑	10.8* ↑	10.6* ↘
10.5* ↑	10.7* ↑	10.7* →	10.8* ↑	10.8* ←

beste Teiler: 39.0 (14.), 41.7 (19.), 48.6 (20.)
 Trefferlage: 0.06 mm rechts, 0.66 mm hoch
 Streuwert: 0.49, horizontal: 0.44, vertikal: 0.54

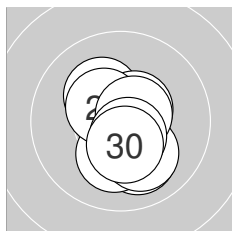

Serie 3: 103.8 (100)

10.8* →	10.0 ↓	10.2* ↘	10.5* ↗	10.2* ↓
10.1 ↓	10.4* ↖	10.6* →	10.6* ↓	10.4* ↓

beste Teiler: 37.6 (21.), 86.3 (28.), 96.6 (29.)
 Trefferlage: 0.23 mm rechts, 0.45 mm tief
 Streuwert: 1.08, horizontal: 0.79, vertikal: 1.31

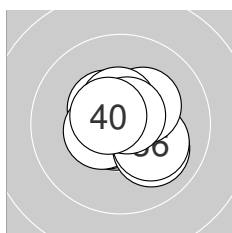

Serie 4: 104.5 (100)

10.5* ↘	10.7* ↗	10.6* ←	10.5* ←	10.0 ↘
10.1 ↘	10.3* ↗	10.5* ↑	10.7* ↗	10.6* ↘

beste Teiler: 52.6 (32.), 63.6 (39.), 85.4 (33.)
 Trefferlage: 0.13 mm rechts, 0.03 mm hoch
 Streuwert: 1.01, horizontal: 1.11, vertikal: 0.90



Ergebnis: **414.5** (398)
 Serien: 102.3 104.5 103.4 104.3
 Zähler: 38 2 0 0 0 0 0 0 0 0
 Innenzehner: 33
 Weitest: 324 (21.), 279 (3.), 243 (2.)
 beste Teiler: 25.4 (24.), 27.0 (36.), 46.3 (20.)
 Trefferlage: 0.01 mm rechts, 0.10 mm hoch
 Streuwert: 1.16, horizontal: 1.21, vertikal: 1.11

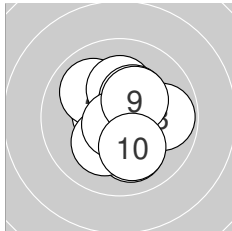
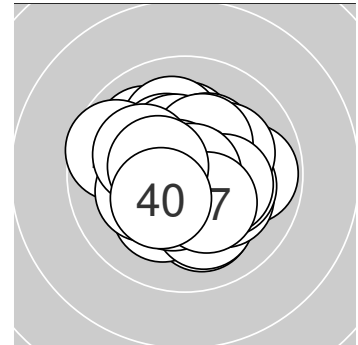

Serie 1: 102.3 (99)

10.6* ←	10.0 ↘	9.8 →	10.2* ↑	10.3* ↗
10.1 ↓	10.2* ↙	10.7* ↘	10.3* ↗	10.1 ↓

beste Teiler: 56.9 (8.), 94.7 (1.), 152.2 (5.)
 Trefferlage: 0.23 mm rechts, 0.00 mm
 Streuwert: 1.41, horizontal: 1.30, vertikal: 1.51

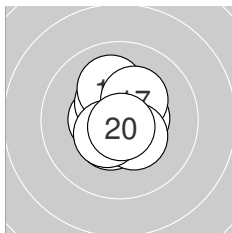

Serie 2: 104.5 (100)

10.5* ←	10.5* ↑	10.5* →	10.4* ↘	10.5* ↙
10.1 ↑	10.3* ↗	10.4* ↘	10.5* ↙	10.8* ↓

beste Teiler: 46.3 (20.), 110.8 (13.), 120.1 (11.)
 Trefferlage: 0.11 mm links, 0.24 mm hoch
 Streuwert: 1.01, horizontal: 0.85, vertikal: 1.14

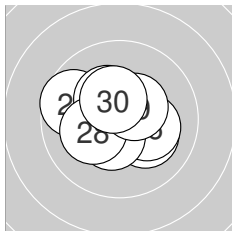

Serie 3: 103.4 (99)

9.7 ←	10.2* ↘	10.3* ↘	10.9* ↗	10.7* ↗
10.2* →	10.4* ↙	10.2* ←	10.4* ↗	10.4* ↑

beste Teiler: 25.4 (24.), 61.7 (25.), 127.5 (27.)
 Trefferlage: 0.13 mm links, 0.15 mm hoch
 Streuwert: 1.28, horizontal: 1.53, vertikal: 0.97

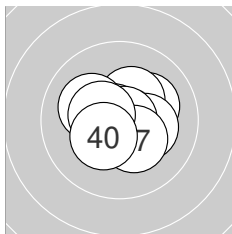

Serie 4: 104.3 (100)

10.7* ↙	10.2* ↗	10.3* ↗	10.3* →	10.8* ↘
10.8* →	10.3* ↘	10.1 ←	10.5* ←	10.3* ↙

beste Teiler: 27.0 (36.), 48.8 (35.), 68.3 (31.)
 Trefferlage: 0.06 mm rechts, 0.02 mm hoch
 Streuwert: 1.07, horizontal: 1.24, vertikal: 0.88



Ergebnis: **412.6** (396)
 Serien: 102.1 104.0 103.4 103.1
 Zähler: 36 4 0 0 0 0 0 0 0 0
 Innenzehner: 29
 Weitestе: 399 (1.), 311 (40.), 275 (6.)
 beste Teiler: 64.5 (24.), 71.4 (17.), 76.5 (12.)
 Trefferlage: 0.56 mm links, 0.21 mm hoch
 Streuwert: 1.18, horizontal: 1.30, vertikal: 1.05

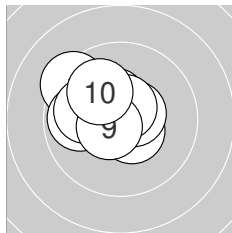
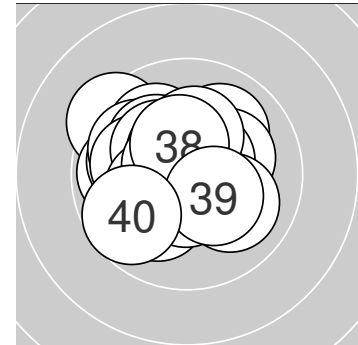

Serie 1: 102.1 (98)

9.4 ↘	10.5* ↘	10.4* ↑	10.6* →	10.1 ←
9.9 ←	10.0 ←	10.6* ↑	10.6* ↙	10.0 ↘

beste Teiler: 84.2 (8.), 91.8 (9.), 94.0 (4.)
 Trefferlage: 1.10 mm links, 0.67 mm hoch
 Streuwert: 1.24, horizontal: 1.46, vertikal: 0.98

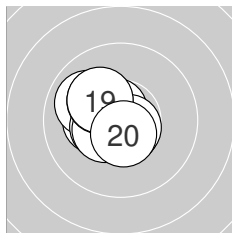

Serie 2: 104.0 (99)

10.3* ←	10.6* ↘	9.9 ↘	10.6* ↓	10.4* ←
10.5* ↙	10.7* ↘	10.2* ↘	10.2* ↘	10.6* ↓

beste Teiler: 71.4 (17.), 76.5 (12.), 80.0 (14.)
 Trefferlage: 0.83 mm links, 0.12 mm hoch
 Streuwert: 0.93, horizontal: 0.95, vertikal: 0.90

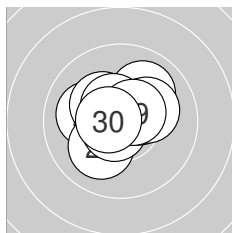

Serie 3: 103.4 (100)

10.1 ←	10.0 ↗	10.1 ↗	10.7* ↗	10.3* ↘
10.5* ↘	10.4* ↗	10.2* →	10.5* ↗	10.6* ←

beste Teiler: 64.5 (24.), 82.4 (30.), 103.2 (29.)
 Trefferlage: 0.11 mm links, 0.43 mm hoch
 Streuwert: 1.18, horizontal: 1.35, vertikal: 0.97

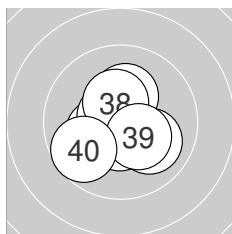

Serie 4: 103.1 (99)

10.3* ↙	10.6* ↘	10.0 ↘	10.5* ↙	10.5* ↓
10.2* ↑	10.6* ↘	10.4* ↑	10.3* ↘	9.7 ↗

beste Teiler: 82.8 (37.), 97.0 (32.), 107.1 (35.)
 Trefferlage: 0.19 mm links, 0.38 mm tief
 Streuwert: 1.24, horizontal: 1.30, vertikal: 1.17



LG 40 ZR

StandNr: 128

Wallner,, Florian #70807099

Senioren_1m

Wertung

StartNr: 114

03.03.2024 13:41

SG_Jenbach-Buch

Ergebnis: **0.0** (0)_{DNS}
Serien:
Zähler: 0 0 0 0 0 0 0 0 0 0 0
Innenzehner: 0
Weiteste:
~~beste Teiler~~
Trefferlage: 0.00 mm , 0.00 mm
Streuwert:

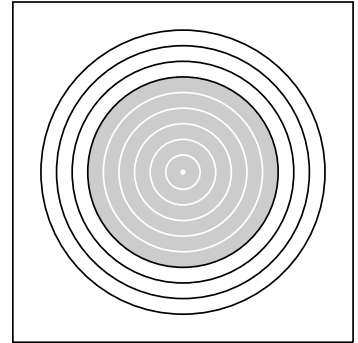

Ergebnis: **413.6** (391)
 Serien: 104.8 97.8 105.8 105.2
 Zähler: 38 1 0 0 0 0 0 0 1 0 0
 Innenzehner: 37
 Weitester: 2051 (20.), 324 (3.), 220 (12.)
 beste Teiler: 33.0 (19.), 34.0 (35.), 35.3 (18.)
 Trefferlage: 0.03 mm rechts, 0.39 mm tief
 Streuwert: 2.46, horizontal: 1.73, vertikal: 3.02

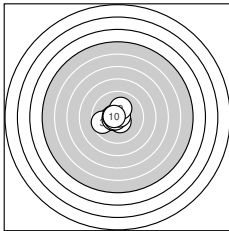
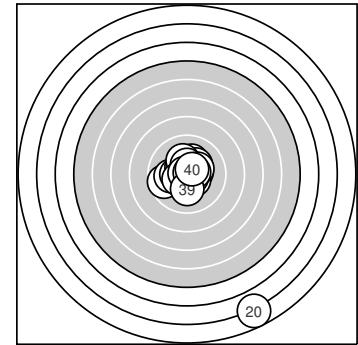

Serie 1: 104.8 (99)

10.7* ↘	10.3* ←	9.7 ←	10.5* ↓	10.6* ←
10.6* ←	10.7* ↗	10.8* ↗	10.2* ↑	10.7* ←

beste Teiler: 46.0 (8.), 55.8 (7.), 60.8 (1.)
 Trefferlage: 0.55 mm links, 0.09 mm tief
 Streuwert: 0.99, horizontal: 1.15, vertikal: 0.80

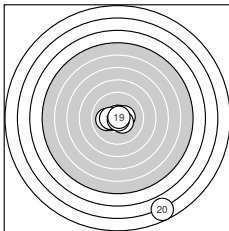

Serie 2: 97.8 (92)

10.8* ↑	10.1 ←	10.4* →	10.5* ↓	10.8* ↘
10.5* ←	10.4* ←	10.8* ↓	10.8* ↗	2.7 ↓

beste Teiler: 33.0 (19.), 35.3 (18.), 41.8 (15.)
 Trefferlage: 0.69 mm rechts, 1.87 mm tief
 Streuwert: 4.67, horizontal: 3.12, vertikal: 5.82

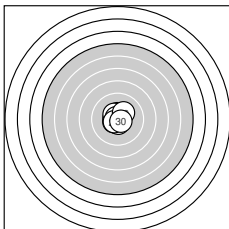

Serie 3: 105.8 (100)

10.7* ↙	10.6* ↗	10.6* ←	10.6* ↓	10.5* ↑
10.5* ↘	10.8* ↘	10.6* ↗	10.3* ↗	10.6* ↘

beste Teiler: 41.0 (27.), 65.3 (21.), 76.4 (23.)
 Trefferlage: 0.14 mm links, 0.10 mm hoch
 Streuwert: 0.73, horizontal: 0.66, vertikal: 0.79

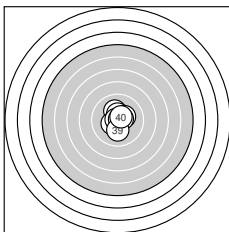

Serie 4: 105.2 (100)

10.2* ↑	10.8* ↑	10.5* ↑	10.4* ←	10.8* ↘
10.8* ↗	10.3* ↗	10.6* →	10.2* ↓	10.6* ↗

beste Teiler: 34.0 (35.), 41.1 (32.), 44.2 (36.)
 Trefferlage: 0.14 mm rechts, 0.28 mm hoch
 Streuwert: 0.90, horizontal: 0.74, vertikal: 1.04



Ergebnis: 410.2 (394)
Serien: 102.8 101.0 102.4 104.0
Zähler: 34 6 0 0 0 0 0 0 0 0 0
Innenzehner: 26
Weiteste: 421 (3.), 364 (18.), 347 (23.)
beste Teiler: 38.0 (7.), 49.0 (2.), 77.4 (17.)
Trefferlage: 0.22 mm links, 0.17 mm hoch
Streuwert: 1.38, horizontal: 1.64, vertikal: 1.05

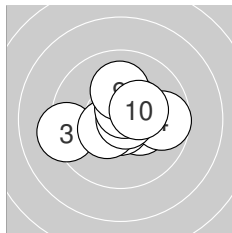
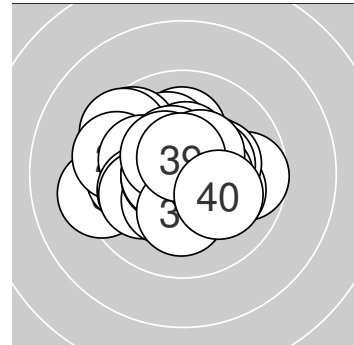

Serie 1: 102.8 (98)

10.3* →	10.8* ↓	9.3 ←	9.7 →	10.5* ↙
10.4* ↗	10.8* →	10.6* ↑	10.1 ↑	10.3* ↘

beste Teiler: 38.0 (7.), 49.0 (2.), 84.7 (8.)
Trefferlage: 0.23 mm rechts, 0.18 mm hoch
Streuwert: 1.50, horizontal: 1.89, vertikal: 0.96

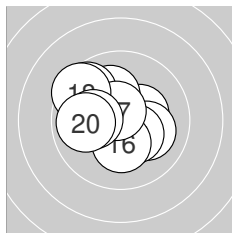

Serie 2: 101.0 (97)

10.4* →	10.1 ↖	9.6 ↘	10.1 →	10.4* ↘
10.3* ↓	10.6* ↖	9.5 ↘	10.1 ←	9.9 ←

beste Teiler: 77.4 (17.), 147.0 (15.), 149.5 (11.)
Trefferlage: 0.68 mm links, 0.36 mm hoch
Streuwert: 1.60, horizontal: 1.81, vertikal: 1.37

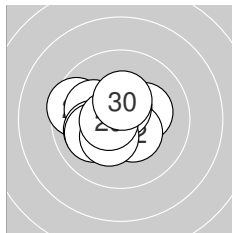

Serie 3: 102.4 (99)

10.2* →	10.4* ↘	9.6 ←	10.6* ↑	10.1 ↖
10.1 ←	10.1 ↙	10.3* ↗	10.6* ←	10.4* ↑

beste Teiler: 84.3 (24.), 89.8 (29.), 136.5 (22.)
Trefferlage: 0.83 mm links, 0.01 mm hoch
Streuwert: 1.31, horizontal: 1.57, vertikal: 0.99

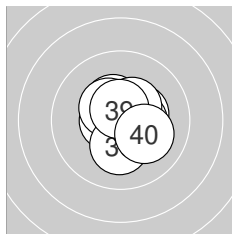

Serie 4: 104.0 (100)

10.4* →	10.5* →	10.6* ←	10.4* ↖	10.4* ↖
10.2* ↓	10.4* →	10.4* ↗	10.6* ↑	10.1 ↘

beste Teiler: 84.4 (39.), 89.1 (33.), 105.2 (32.)
Trefferlage: 0.38 mm rechts, 0.14 mm hoch
Streuwert: 1.00, horizontal: 1.01, vertikal: 0.98



Ergebnis: 416.4 (397)
Serien: 104.1 104.4 104.8 103.1
Zähler: 37 3 0 0 0 0 0 0 0 0 0
Innenzehner: 34
Weiteste: 337 (16.), 280 (32.), 266 (11.)
beste Teiler: 5.8 (28.), 26.6 (13.), 28.0 (12.)
Trefferlage: 0.24 mm rechts, 0.26 mm hoch
Streuwert: 1.06, horizontal: 1.01, vertikal: 1.10

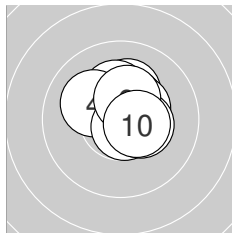
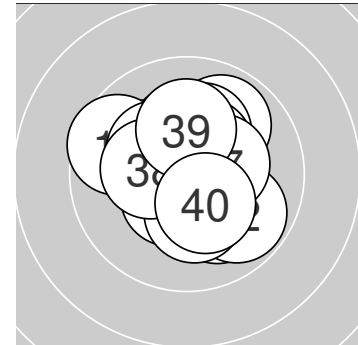

Serie 1: 104.1 (100)

10.2* ↑	10.3* ↑	10.4* ↗	10.1 ↖	10.7* ↘
10.4* ↘	10.7* ↓	10.4* →	10.4* ↑	10.5* →

beste Teiler: 57.2 (7.), 71.4 (5.), 113.3 (10.)
Trefferlage: 0.37 mm rechts, 0.71 mm hoch
Streuwert: 0.89, horizontal: 0.91, vertikal: 0.87

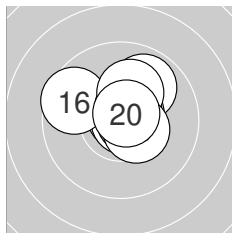

Serie 2: 104.4 (98)

9.9 ↗	10.8* ↑	10.8* →	10.6* ↗	10.7* →
9.6 ↖	10.6* ↗	10.2* ↑	10.5* ↘	10.7* ↗

beste Teiler: 26.6 (13.), 28.0 (12.), 58.8 (20.)
Trefferlage: 0.25 mm rechts, 0.66 mm hoch
Streuwert: 1.09, horizontal: 1.25, vertikal: 0.88

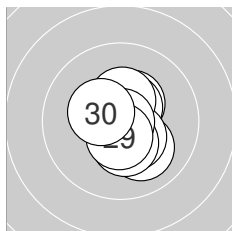

Serie 3: 104.8 (100)

10.4* ↗	10.5* ↗	10.1 ↓	10.8* ↖	10.4* ↓
10.4* ↓	10.4* ↑	10.9* ↓	10.5* ↓	10.4* ↖

beste Teiler: 5.8 (28.), 30.0 (24.), 101.4 (29.)
Trefferlage: 0.23 mm rechts, 0.14 mm tief
Streuwert: 0.96, horizontal: 0.73, vertikal: 1.14

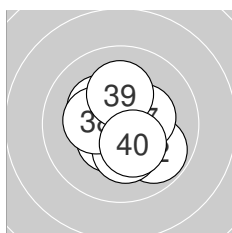

Serie 4: 103.1 (99)

10.6* ↖	9.8 ↘	10.6* ↘	10.3* ↖	10.5* ↗
10.3* ↓	10.3* →	10.3* ←	10.1 ↑	10.3* ↓

beste Teiler: 85.4 (31.), 96.0 (33.), 122.2 (35.)
Trefferlage: 0.13 mm rechts, 0.18 mm tief
Streuwert: 1.25, horizontal: 1.23, vertikal: 1.27



Ergebnis: **395.2** (375)
 Serien: 95.6 98.4 100.1 101.1
 Zähler: 19 18 2 1 0 0 0 0 0 0
 Innenzehner: 14
 Weitester: 798 (16.), 654 (38.), 535 (4.)
 beste Teiler: 10.6 (28.), 62.2 (33.), 70.0 (32.)
 Trefferlage: 0.00 mm , 0.20 mm hoch
 Streuwert: 2.23, horizontal: 2.86, vertikal: 1.33

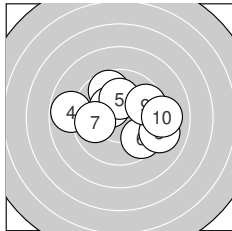
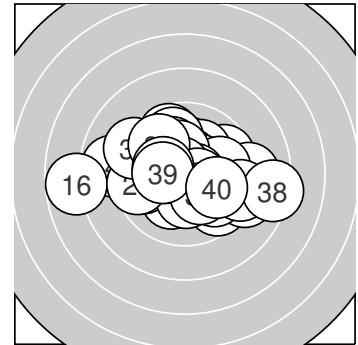

Serie 1: 95.6 (91)

9.3 →	9.7 ↗	10.3* ↘	8.8 ←	10.1 ↑
9.6 ↘	9.9 ←	9.1 →	9.7 →	9.1 →

beste Teiler: 154.1 (3.), 203.0 (5.), 274.1 (7.)
 Trefferlage: 0.80 mm rechts, 0.36 mm hoch
 Streuwert: 2.64, horizontal: 3.38, vertikal: 1.59

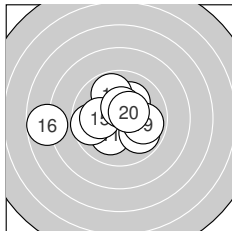

Serie 2: 98.4 (93)

10.1 ↙	10.1 ↗	9.8 ↗	9.7 ←	10.1 ←
7.8 ←	10.5* ↑	9.9 ↘	9.9 →	10.5* ↗

beste Teiler: 121.3 (17.), 122.3 (20.), 203.2 (11.)
 Trefferlage: 0.80 mm links, 0.09 mm hoch
 Streuwert: 2.42, horizontal: 3.10, vertikal: 1.45

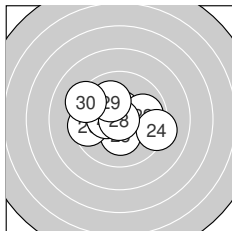

Serie 3: 100.1 (95)

10.6* ↑	9.9 →	10.3* ↓	9.3 →	9.8 ↘
9.5 ←	10.4* ←	10.9* ↙	10.1 ↗	9.3 ↘

beste Teiler: 10.6 (28.), 91.0 (21.), 142.4 (27.)
 Trefferlage: 0.55 mm links, 0.27 mm hoch
 Streuwert: 1.96, horizontal: 2.48, vertikal: 1.24

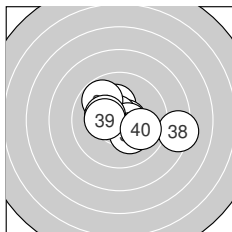

Serie 4: 101.1 (96)

10.3* ↗	10.7* →	10.7* ↘	10.6* →	10.2* ↘
9.8 ↘	10.3* ←	8.3 →	10.3* ←	9.9 →

beste Teiler: 62.2 (33.), 70.0 (32.), 96.5 (34.)
 Trefferlage: 0.55 mm rechts, 0.09 mm hoch
 Streuwert: 1.94, horizontal: 2.48, vertikal: 1.18



Ergebnis: **412.5** (393)
 Serien: 103.5 101.9 102.8 104.3
 Zähler: 33 7 0 0 0 0 0 0 0 0
 Innenzehner: 30
 Weitesten: 412 (11.), 402 (35.), 319 (27.)
 beste Teiler: 5.0 (37.), 42.5 (16.), 43.0 (20.)
 Trefferlage: 0.06 mm rechts, 0.43 mm tief
 Streuwert: 1.29, horizontal: 1.46, vertikal: 1.09

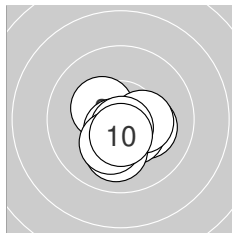
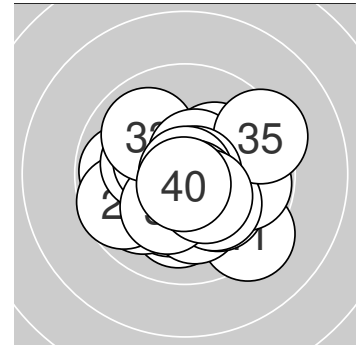

Serie 1: 103.5 (100)

10.2* →	10.2* ↓	10.3* ↖	10.4* ↘	10.3* →
10.6* ↙	10.7* ↓	10.1 ↓	10.2* ↙	10.5* ↓

beste Teiler: 61.6 (7.), 85.8 (6.), 112.0 (10.)
 Trefferlage: 0.12 mm rechts, 0.92 mm tief
 Streuwert: 0.94, horizontal: 1.00, vertikal: 0.89

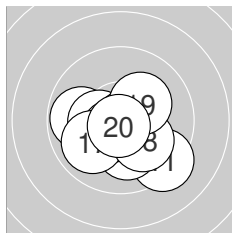

Serie 2: 101.9 (97)

9.3 ↘	10.1 ↓	9.8 ←	10.3* ←	10.6* ↙
10.8* →	9.9 ↙	10.1 ↘	10.2* ↗	10.8* ↓

beste Teiler: 42.5 (16.), 43.0 (20.), 93.6 (15.)
 Trefferlage: 0.01 mm links, 0.78 mm tief
 Streuwert: 1.51, horizontal: 1.77, vertikal: 1.18

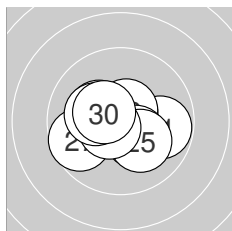

Serie 3: 102.8 (98)

9.8 →	10.7* ↗	10.6* ↗	10.3* ↘	10.2* ↘
10.3* ↖	9.7 ↙	10.6* ↙	10.2* ←	10.4* ↖

beste Teiler: 71.0 (22.), 86.7 (23.), 92.2 (28.)
 Trefferlage: 0.21 mm links, 0.15 mm tief
 Streuwert: 1.38, horizontal: 1.74, vertikal: 0.89

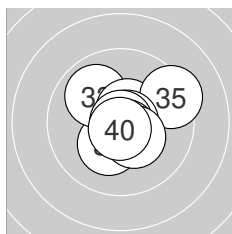

Serie 4: 104.3 (98)

10.2* ↙	10.7* ↗	9.9 ↘	10.6* ↗	9.3 ↗
10.8* →	10.9* ↗	10.7* ↘	10.4* ↘	10.8* ↓

beste Teiler: 5.0 (37.), 46.1 (36.), 48.3 (40.)
 Trefferlage: 0.35 mm rechts, 0.14 mm hoch
 Streuwert: 1.26, horizontal: 1.38, vertikal: 1.14



Ergebnis: 407.8 (391)
Serien: 101.8 103.3 99.9 102.8
Zähler: 31 9 0 0 0 0 0 0 0 0
Innenzehner: 22
Weiteste: 430 (30.), 403 (32.), 381 (25.)
beste Teiler: 9.2 (31.), 19.4 (37.), 31.4 (35.)
Trefferlage: 0.88 mm rechts, 0.11 mm tief
Streuwert: 1.43, horizontal: 1.57, vertikal: 1.27

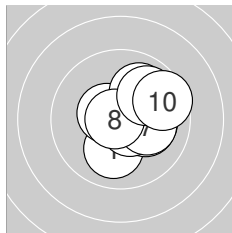
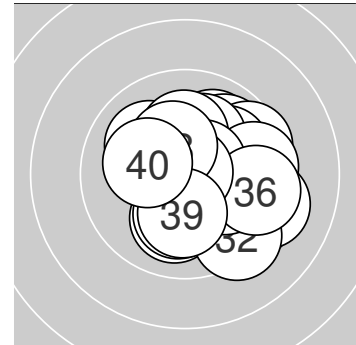

Serie 1: 101.8 (98)

10.0 ↓	10.5* ↖	10.2* →	10.1 →	10.0 ↗
10.6* ↘	10.1 →	10.8* ←	9.9 ↗	9.6 ↘

beste Teiler: 44.0 (8.), 89.0 (6.), 113.3 (2.)
Trefferlage: 1.10 mm rechts, 0.16 mm hoch
Streuwert: 1.33, horizontal: 1.38, vertikal: 1.28

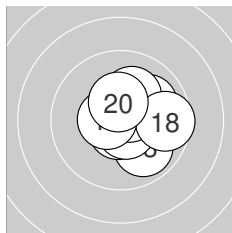

Serie 2: 103.3 (98)

10.8* ←	10.0 ↗	9.9 ↘	10.7* ↓	10.6* ↘
10.6* ↗	10.2* ↗	9.6 →	10.5* ←	10.4* ↑

beste Teiler: 32.9 (11.), 73.2 (14.), 80.2 (15.)
Trefferlage: 0.73 mm rechts, 0.14 mm hoch
Streuwert: 1.23, horizontal: 1.31, vertikal: 1.14

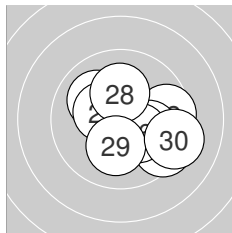

Serie 3: 99.9 (97)

10.7* ↓	9.6 →	10.0 →	10.0 ↖	9.4 ↘
10.3* ↘	10.4* ↖	10.2* ↑	10.1 ↓	9.2 →

beste Teiler: 72.4 (21.), 144.8 (27.), 167.4 (26.)
Trefferlage: 1.06 mm rechts, 0.38 mm tief
Streuwert: 1.77, horizontal: 2.06, vertikal: 1.41

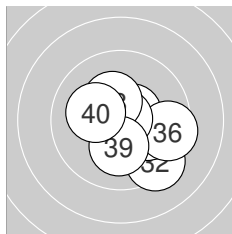

Serie 4: 102.8 (98)

10.9* ↗	9.3 ↘	10.1 →	10.6* ↗	10.8* ↖
9.5 →	10.9* ↗	10.3* ↖	10.2* ↓	10.2* ↖

beste Teiler: 9.2 (31.), 19.4 (37.), 31.4 (35.)
Trefferlage: 0.64 mm rechts, 0.37 mm tief
Streuwert: 1.49, horizontal: 1.63, vertikal: 1.33



Ergebnis: 417.2 (399)
Serien: 103.6 105.7 104.7 103.2
Zähler: 39 1 0 0 0 0 0 0 0 0
Innenzehner: 34
Weiteste: 329 (6.), 228 (35.), 219 (7.)
beste Teiler: 26.9 (26.), 33.5 (18.), 53.7 (15.)
Trefferlage: 0.33 mm rechts, 0.02 mm hoch
Streuwert: 1.01, horizontal: 0.88, vertikal: 1.13

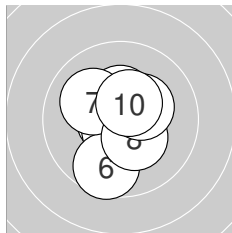
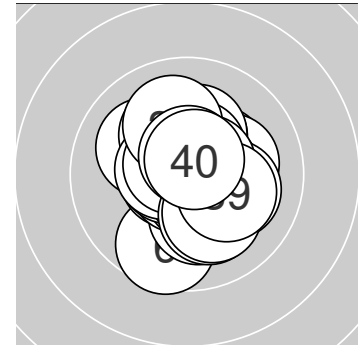

Serie 1: 103.6 (99)

10.4* ↑	10.7* →	10.4* ↘	10.7* ←	10.6* ↙
9.6 ↙	10.1 ↖	10.3* ↘	10.3* →	10.5* ↗

beste Teiler: 65.1 (2.), 73.5 (4.), 87.2 (5.)
Trefferlage: 0.04 mm rechts, 0.16 mm tief
Streuwert: 1.23, horizontal: 1.01, vertikal: 1.41

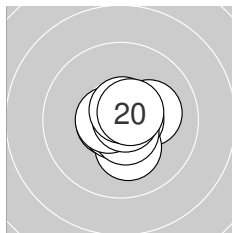

Serie 2: 105.7 (100)

10.2* →	10.6* ←	10.7* →	10.2* ↓	10.7* ↗
10.6* ↓	10.6* ←	10.8* →	10.7* ↑	10.6* ↗

beste Teiler: 33.5 (18.), 53.7 (15.), 67.1 (13.)
Trefferlage: 0.25 mm rechts, 0.12 mm tief
Streuwert: 0.77, horizontal: 0.80, vertikal: 0.74

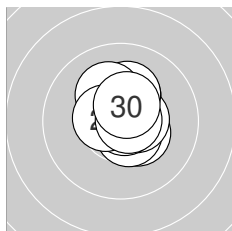

Serie 3: 104.7 (100)

10.4* ↘	10.3* ↑	10.6* ↘	10.5* →	10.2* ↑
10.8* →	10.2* ↖	10.5* ←	10.7* →	10.5* ↑

beste Teiler: 26.9 (26.), 54.5 (29.), 98.7 (23.)
Trefferlage: 0.30 mm rechts, 0.50 mm hoch
Streuwert: 0.87, horizontal: 0.70, vertikal: 1.01

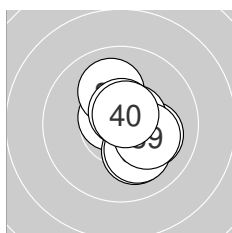

Serie 4: 103.2 (100)

10.6* ↖	10.1 ↓	10.1 →	10.2* ↘	10.0 ↑
10.6* ↑	10.6* ↗	10.1 ↓	10.2* →	10.7* ↗

beste Teiler: 73.7 (40.), 77.4 (31.), 83.2 (36.)
Trefferlage: 0.75 mm rechts, 0.13 mm tief
Streuwert: 1.11, horizontal: 0.95, vertikal: 1.26



Ergebnis: **412.5** (394)
 Serien: 101.7 101.9 104.4 104.5
 Zähler: 34 6 0 0 0 0 0 0 0 0
 Innenzehner: 32
 Weitester: 455 (5.), 436 (15.), 371 (7.)
 beste Teiler: 32.2 (35.), 39.8 (1.), 41.2 (24.)
 Trefferlage: 0.06 mm rechts, 0.11 mm hoch
 Streuwert: 1.33, horizontal: 1.59, vertikal: 1.00

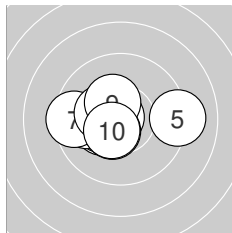
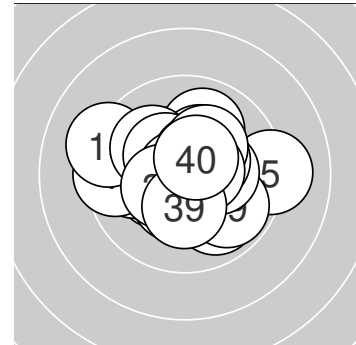

Serie 1: 101.7 (97)

10.8* ↖	10.3* ↙	10.4* ↖	9.9 ←	9.1 →
10.5* ↘	9.5 ←	10.3* ↖	10.4* ↖	10.5* ↘

beste Teiler: 39.8 (1.), 113.8 (10.), 115.1 (6.)
 Trefferlage: 0.85 mm links, 0.09 mm tief
 Streuwert: 1.60, horizontal: 2.16, vertikal: 0.69

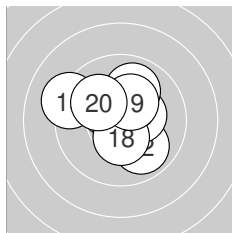

Serie 2: 101.9 (98)

10.4* ↖	9.9 ↘	10.7* ↓	10.5* ↗	9.2 ↖
10.4* →	10.0 ↑	10.4* ↓	10.3* ↗	10.1 ↖

beste Teiler: 74.3 (13.), 120.3 (14.), 134.3 (11.)
 Trefferlage: 0.08 mm links, 0.44 mm hoch
 Streuwert: 1.59, horizontal: 1.76, vertikal: 1.41

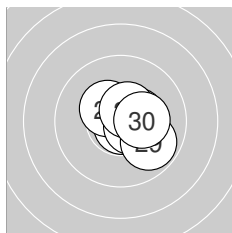

Serie 3: 104.4 (99)

10.4* →	10.4* →	10.7* ↗	10.8* ↓	10.5* →
10.4* ↖	10.6* ↘	10.5* ↗	9.8 ↘	10.3* →

beste Teiler: 41.2 (24.), 67.4 (23.), 98.8 (27.)
 Trefferlage: 0.86 mm rechts, 0.00 mm
 Streuwert: 0.84, horizontal: 0.91, vertikal: 0.77

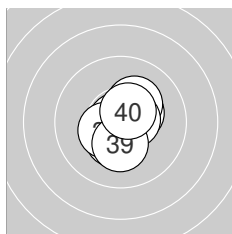

Serie 4: 104.5 (100)

10.6* ↗	10.3* ↗	10.4* ↘	10.4* ↗	10.8* ↖
10.2* ↗	10.6* →	10.4* ↙	10.3* ↓	10.5* ↗

beste Teiler: 32.2 (35.), 77.6 (31.), 94.9 (37.)
 Trefferlage: 0.33 mm rechts, 0.12 mm hoch
 Streuwert: 0.94, horizontal: 0.81, vertikal: 1.05



Ergebnis: 402.5 (386)
Serien: 100.5 100.3 100.6 101.1
Zähler: 28 10 2 0 0 0 0 0 0 0
Innenzehner: 19
Weiteste: 630 (16.), 544 (34.), 442 (8.)
beste Teiler: 14.7 (37.), 58.5 (35.), 66.4 (14.)
Trefferlage: 0.13 mm rechts, 0.20 mm hoch
Streuwert: 1.83, horizontal: 2.00, vertikal: 1.64

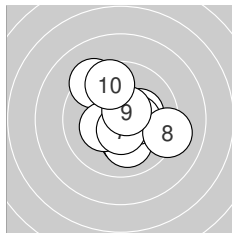
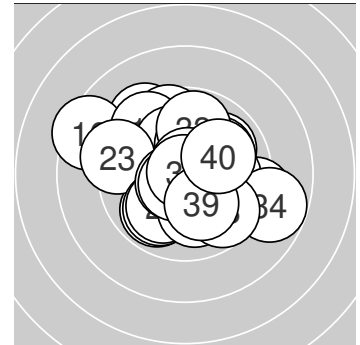

Serie 1: 100.5 (97)

10.2* ↓	10.1 ↓	9.3 ↘	10.3* ↖	10.2* →
10.4* →	10.6* ↓	9.2 →	10.6* ↗	9.6 ↑

beste Teiler: 93.2 (9.), 95.1 (7.), 141.1 (6.)
Trefferlage: 0.40 mm rechts, 0.07 mm hoch
Streuwert: 1.88, horizontal: 1.86, vertikal: 1.89

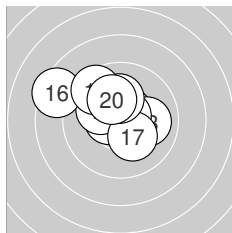

Serie 2: 100.3 (97)

10.6* ↗	10.5* ←	10.0 →	10.7* ↗	10.1 ↖
8.4 ↖	10.2* ↘	10.2* ↑	9.5 ↘	10.1 ↑

beste Teiler: 66.4 (14.), 97.8 (11.), 105.0 (12.)
Trefferlage: 0.72 mm links, 0.96 mm hoch
Streuwert: 1.84, horizontal: 2.25, vertikal: 1.31

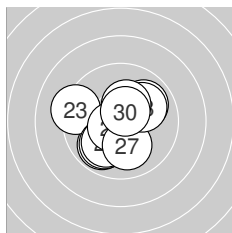

Serie 3: 100.6 (96)

9.9 ↗	9.9 ↖	9.3 ←	9.9 ↖	10.0 ↖
10.6* ↖	10.1 ↓	10.0 ↗	10.3* ↑	10.6* ↑

beste Teiler: 91.5 (26.), 98.4 (30.), 158.1 (29.)
Trefferlage: 0.38 mm links, 0.26 mm tief
Streuwert: 1.77, horizontal: 1.87, vertikal: 1.66

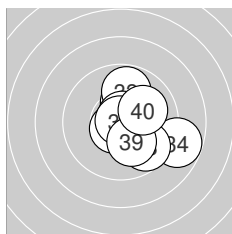

Serie 4: 101.1 (96)

10.2* ↑	10.6* ↖	9.8 ↑	8.8 →	10.7* ↑
10.3* →	10.9* ↘	9.7 ↘	10.1 ↓	10.0 →

beste Teiler: 14.7 (37.), 58.5 (35.), 82.0 (32.)
Trefferlage: 1.23 mm rechts, 0.04 mm hoch
Streuwert: 1.64, horizontal: 1.64, vertikal: 1.64



Ergebnis: **410.1** (391)
 Serien: 102.7 100.4 103.3 103.7
 Zähler: 32 7 1 0 0 0 0 0 0 0
 Innenzehner: 28
 Weitest: 563 (12.), 383 (27.), 370 (13.)
 beste Teiler: 50.2 (8.), 61.0 (16.), 66.7 (32.)
 Trefferlage: 0.17 mm links, 0.06 mm hoch
 Streuwert: 1.45, horizontal: 1.80, vertikal: 0.99

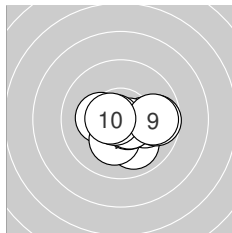
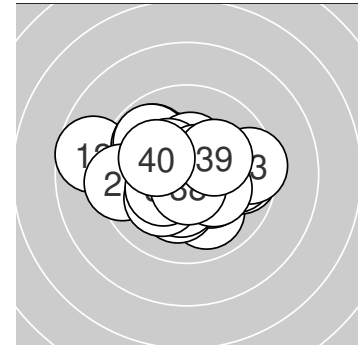

Serie 1: 102.7 (98)

10.0 ↘	10.1 →	10.3* ←	10.2* ↓	9.7 →
10.6* ↘	10.6* ↘	10.8* ←	9.8 →	10.6* ←

beste Teiler: 50.2 (8.), 77.9 (6.), 84.9 (7.)
 Trefferlage: 0.69 mm rechts, 0.50 mm tief
 Streuwert: 1.29, horizontal: 1.64, vertikal: 0.80

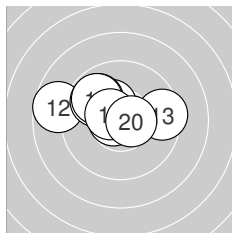

Serie 2: 100.4 (94)

10.6* ↘	8.7 ←	9.5 →	10.3* ↘	9.8 ↘
10.7* ←	9.9 ↘	9.8 ↘	10.5* ↘	10.6* →

beste Teiler: 61.0 (16.), 94.1 (11.), 94.5 (20.)
 Trefferlage: 1.01 mm links, 0.95 mm hoch
 Streuwert: 1.74, horizontal: 2.35, vertikal: 0.74

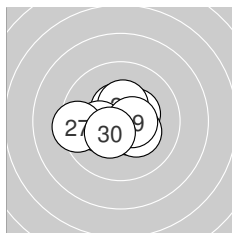

Serie 3: 103.3 (99)

10.6* ↗	10.4* ↗	10.5* ↖	10.4* ↑	10.6* ↘
10.2* ←	9.4 ←	10.3* ↘	10.5* →	10.4* ↗

beste Teiler: 77.1 (21.), 95.1 (25.), 102.3 (29.)
 Trefferlage: 0.20 mm links, 0.00 mm
 Streuwert: 1.30, horizontal: 1.63, vertikal: 0.86

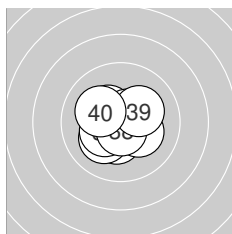

Serie 4: 103.7 (100)

10.4* ↓	10.7* ↘	10.1 ↗	10.4* ↘	10.3* ↗
10.6* ↗	10.2* ↘	10.7* ↓	10.2* ↗	10.1 ↘

beste Teiler: 66.7 (32.), 73.4 (38.), 89.2 (36.)
 Trefferlage: 0.16 mm links, 0.19 mm tief
 Streuwert: 1.13, horizontal: 1.25, vertikal: 1.00



Ergebnis: **409.2** (394)
 Serien: 101.9 101.6 102.4 103.3
 Zähler: 34 6 0 0 0 0 0 0 0 0
 Innenzehner: 23
 Weitest: 319 (30.), 301 (11.), 298 (28.)
 beste Teiler: 35.7 (35.), 63.7 (23.), 76.3 (40.)
 Trefferlage: 0.03 mm links, 0.74 mm tief
 Streuwert: 1.27, horizontal: 1.35, vertikal: 1.18

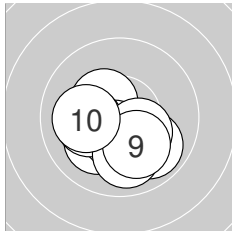
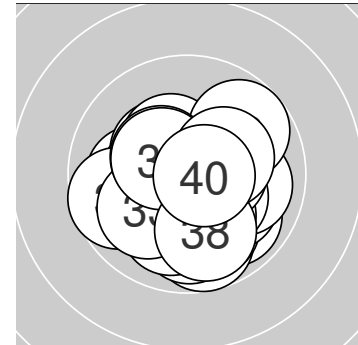

Serie 1: 101.9 (99)

10.1 ↙	10.4* ←	10.4* ↘	10.5* ↓	9.9 ↘
10.1 ←	10.3* ↘	10.0 ↓	10.1 ↓	10.1 ←

beste Teiler: 116.4 (4.), 129.0 (2.), 140.8 (3.)
 Trefferlage: 0.35 mm links, 0.92 mm tief
 Streuwert: 1.27, horizontal: 1.47, vertikal: 1.04

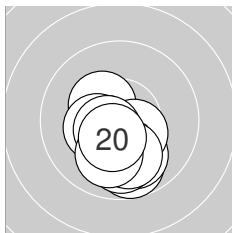

Serie 2: 101.6 (98)

9.7 ↓	10.3* ↘	10.0 ↓	10.3* ←	9.9 ↓
10.4* ↘	10.0 ↓	10.5* ↙	10.0 ↓	10.5* ↓

beste Teiler: 102.8 (18.), 124.6 (20.), 128.1 (16.)
 Trefferlage: 0.13 mm links, 1.44 mm tief
 Streuwert: 1.08, horizontal: 0.91, vertikal: 1.23

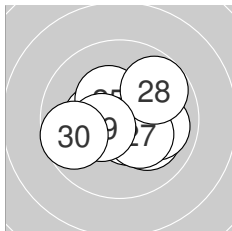

Serie 3: 102.4 (98)

10.1 ↘	10.4* ←	10.7* →	10.6* ↓	10.4* ↘
10.0 →	10.3* ↘	9.8 ↗	10.4* ←	9.7 ←

beste Teiler: 63.7 (23.), 97.0 (24.), 130.1 (29.)
 Trefferlage: 0.26 mm rechts, 0.18 mm tief
 Streuwert: 1.47, horizontal: 1.81, vertikal: 1.03

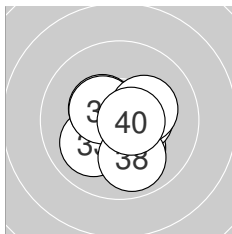

Serie 4: 103.3 (99)

10.2* ↓	10.4* ↙	10.0 ↙	10.4* →	10.8* ↗
10.4* ↘	10.4* ↘	9.9 ↓	10.2* →	10.6* →

beste Teiler: 35.7 (35.), 76.3 (40.), 130.1 (37.)
 Trefferlage: 0.06 mm rechts, 0.43 mm tief
 Streuwert: 1.18, horizontal: 1.19, vertikal: 1.17



Ergebnis: 414.6 (395)
Serien: 104.7 103.5 103.3 103.1
Zähler: 35 5 0 0 0 0 0 0 0 0 0
Innenzehner: 31
Weiteste: 413 (32.), 305 (11.), 301 (14.)
beste Teiler: 38.1 (34.), 47.2 (20.), 56.2 (21.)
Trefferlage: 0.46 mm links, 0.05 mm hoch
Streuwert: 1.15, horizontal: 1.19, vertikal: 1.12

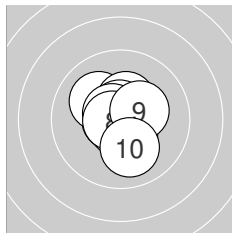
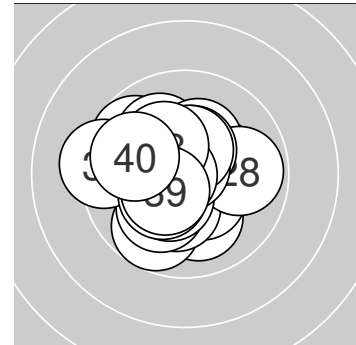

Serie 1: 104.7 (100)

10.7* ←	10.1 ↘	10.4* ↑	10.7* ↓	10.4* ↘
10.7* ↑	10.6* ↘	10.7* ←	10.3* →	10.1 ↓

beste Teiler: 58.1 (4.), 63.9 (8.), 69.2 (1.)
Trefferlage: 0.08 mm links, 0.05 mm hoch
Streuwert: 1.00, horizontal: 0.88, vertikal: 1.11

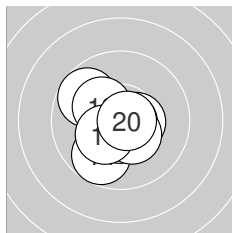

Serie 2: 103.5 (98)

9.7 ↘	10.6* ↙	10.3* ↘	9.7 ↓	10.5* ↓
10.5* →	10.7* →	10.4* ↘	10.3* ↙	10.8* →

beste Teiler: 47.2 (20.), 57.5 (17.), 77.8 (12.)
Trefferlage: 0.43 mm links, 0.38 mm tief
Streuwert: 1.21, horizontal: 1.21, vertikal: 1.21

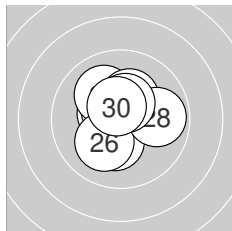

Serie 3: 103.3 (99)

10.7* ↙	10.5* ↘	10.3* ↓	10.5* ↘	10.1 ↘
10.1 ↙	10.3* ↑	9.9 →	10.4* ↑	10.5* ↑

beste Teiler: 56.2 (21.), 102.4 (30.), 104.6 (24.)
Trefferlage: 0.17 mm links, 0.32 mm hoch
Streuwert: 1.22, horizontal: 1.20, vertikal: 1.24

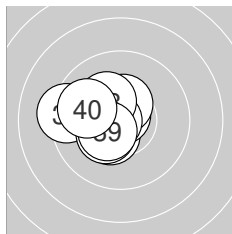

Serie 4: 103.1 (98)

10.6* ↘	9.3 ←	10.4* ↙	10.8* ↑	10.5* ↑
10.7* ←	10.3* ↙	10.2* ↘	10.4* ↙	9.9 ↘

beste Teiler: 38.1 (34.), 62.2 (36.), 99.0 (31.)
Trefferlage: 1.15 mm links, 0.21 mm hoch
Streuwert: 1.12, horizontal: 1.27, vertikal: 0.94



Ergebnis: 406.3 (390)
Serien: 100.4 100.7 102.9 102.3
Zähler: 30 10 0 0 0 0 0 0 0 0 0
Innenzehner: 21
Weiteste: 433 (17.), 394 (25.), 342 (5.)
beste Teiler: 39.0 (33.), 63.0 (26.), 83.6 (9.)
Trefferlage: 0.24 mm links, 0.33 mm tief
Streuwert: 1.52, horizontal: 1.72, vertikal: 1.30

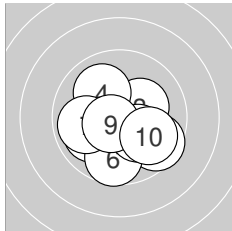
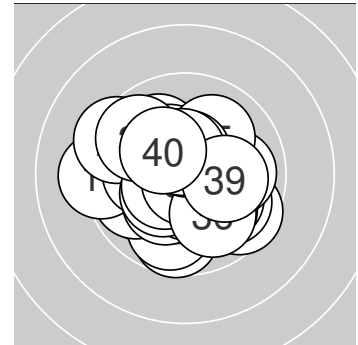

Serie 1: 100.4 (96)

10.3* ←	10.0 ↙	10.2* →	10.0 ↘	9.6 ↘
9.7 ↓	9.9 ←	10.2* ↘	10.6* ↗	9.9 ↘

beste Teiler: 83.6 (9.), 169.8 (1.), 178.4 (3.)
Trefferlage: 0.07 mm links, 0.78 mm tief
Streuwert: 1.69, horizontal: 1.95, vertikal: 1.40

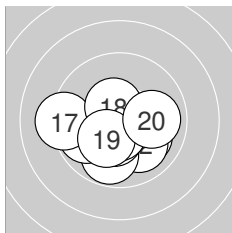

Serie 2: 100.7 (97)

10.1 ↘	10.0 ↘	9.8 ↓	9.8 ←	10.4* ↓
10.6* ↓	9.2 ←	10.5* ↘	10.3* ↗	10.0 →

beste Teiler: 94.7 (16.), 114.1 (18.), 141.9 (15.)
Trefferlage: 0.38 mm links, 0.95 mm tief
Streuwert: 1.63, horizontal: 2.05, vertikal: 1.06

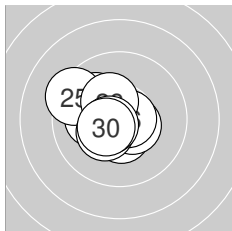

Serie 3: 102.9 (99)

10.5* ↓	10.1 ←	10.5* ↘	10.0 ↘	9.4 ↘
10.7* →	10.3* ↗	10.3* ↘	10.6* ↗	10.5* ↗

beste Teiler: 63.0 (26.), 90.0 (29.), 111.3 (23.)
Trefferlage: 0.94 mm links, 0.08 mm hoch
Streuwert: 1.21, horizontal: 1.34, vertikal: 1.06

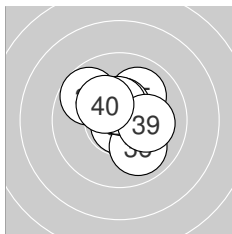

Serie 4: 102.3 (98)

10.3* →	10.2* ↘	10.8* ↓	9.7 ↘	10.0 ↗
9.9 ↘	10.5* ↑	10.5* ↑	10.1 →	10.3* ↘

beste Teiler: 39.0 (33.), 106.9 (37.), 115.9 (38.)
Trefferlage: 0.40 mm rechts, 0.31 mm hoch
Streuwert: 1.37, horizontal: 1.39, vertikal: 1.35



Ergebnis: **412.2** (392)
 Serien: 103.1 102.6 106.2 100.3
 Zähler: 32 8 0 0 0 0 0 0 0 0
 Innenzehner: 28
 Weitester: 483 (37.), 405 (35.), 324 (4.)
 beste Teiler: 12.0 (29.), 57.2 (30.), 64.3 (18.)
 Trefferlage: 0.43 mm links, 0.28 mm hoch
 Streuwert: 1.33, horizontal: 1.41, vertikal: 1.25

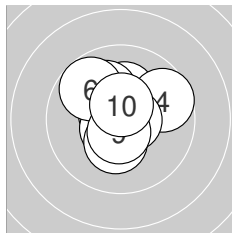
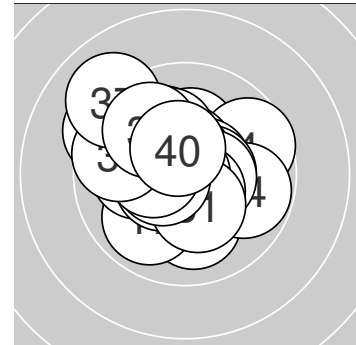

Serie 1: 103.1 (98)

10.6* ↖	10.6* ↙	10.2* ↑	9.7 ↗	10.1 ↘
9.8 ↘	10.7* →	10.3* ↓	10.6* ↓	10.5* ↑

beste Teiler: 68.1 (7.), 89.8 (1.), 90.7 (9.)
 Trefferlage: 0.10 mm links, 0.55 mm hoch
 Streuwert: 1.31, horizontal: 1.32, vertikal: 1.30

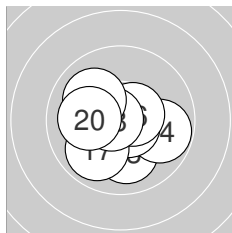

Serie 2: 102.6 (98)

10.5* ↘	10.3* ↘	10.0 ↓	9.8 ↗	10.7* ↘
10.6* ↗	9.9 ↙	10.7* ←	10.0 ↖	10.1 ←

beste Teiler: 64.3 (18.), 67.4 (15.), 95.2 (16.)
 Trefferlage: 0.02 mm rechts, 0.53 mm tief
 Streuwert: 1.37, horizontal: 1.58, vertikal: 1.12

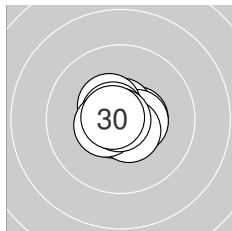

Serie 3: 106.2 (100)

10.6* ↙	10.5* →	10.7* ↑	10.5* →	10.5* ↘
10.7* ↖	10.6* ↘	10.5* ←	10.9* ←	10.7* ←

beste Teiler: 12.0 (29.), 57.2 (30.), 66.0 (26.)
 Trefferlage: 0.08 mm links, 0.02 mm hoch
 Streuwert: 0.67, horizontal: 0.78, vertikal: 0.54

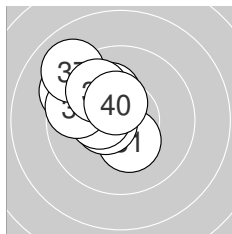

Serie 4: 100.3 (96)

10.3* ↓	10.5* ↖	10.5* ←	10.4* ←	9.3 ↖
9.7 ←	9.0 ↖	10.2* ↖	9.9 ↖	10.5* ↑

beste Teiler: 106.5 (33.), 121.0 (32.), 125.6 (40.)
 Trefferlage: 1.56 mm links, 1.08 mm hoch
 Streuwert: 1.37, horizontal: 1.37, vertikal: 1.38



Ergebnis: **421.0** (399)
 Serien: 105.7 106.3 105.1 103.9
 Zähler: 39 1 0 0 0 0 0 0 0 0
 Innenzehner: 36
 Weitestе: 258 (30.), 236 (34.), 225 (28.)
 beste Teiler: 29.4 (4.), 38.9 (15.), 46.2 (23.)
 Trefferlage: 0.05 mm rechts, 0.08 mm tief
 Streuwert: 0.86, horizontal: 0.95, vertikal: 0.77

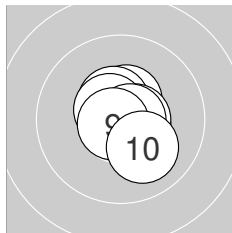
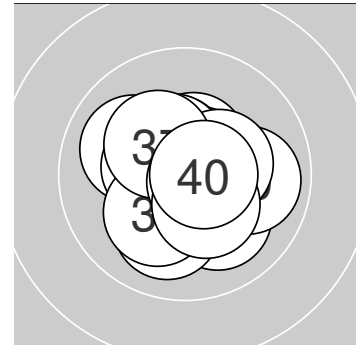

Serie 1: 105.7 (100)

10.6* ↘	10.5* ↑	10.6* ↘	10.8* →	10.5* ↖
10.6* →	10.6* ↘	10.7* →	10.7* ↖	10.1 ↘

beste Teiler: 29.4 (4.), 53.5 (9.), 58.1 (8.)
 Trefferlage: 0.34 mm rechts, 0.03 mm tief
 Streuwert: 0.76, horizontal: 0.67, vertikal: 0.85

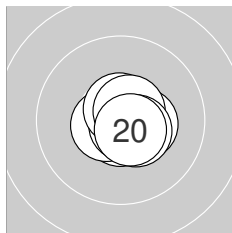

Serie 2: 106.3 (100)

10.7* ↖	10.7* ↓	10.6* ↖	10.7* ↘	10.8* ↘
10.4* →	10.7* ↑	10.6* ↗	10.5* ↘	10.6* ↘

beste Teiler: 38.9 (15.), 56.4 (14.), 63.0 (12.)
 Trefferlage: 0.25 mm rechts, 0.21 mm tief
 Streuwert: 0.58, horizontal: 0.68, vertikal: 0.47

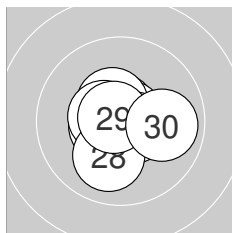

Serie 3: 105.1 (99)

10.7* ↑	10.7* ↗	10.8* ↖	10.5* ↖	10.5* ↖
10.5* ↖	10.6* ↘	10.1 ↓	10.8* ↖	9.9 →

beste Teiler: 46.2 (23.), 49.2 (29.), 54.3 (22.)
 Trefferlage: 0.02 mm links, 0.08 mm tief
 Streuwert: 0.98, horizontal: 1.08, vertikal: 0.87

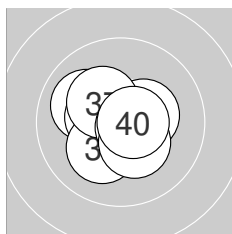

Serie 4: 103.9 (100)

10.4* →	10.3* ↖	10.7* ↖	10.0 ↖	10.4* ↖
10.2* ↖	10.3* ↖	10.7* ↘	10.3* ↘	10.6* →

beste Teiler: 68.6 (33.), 73.3 (38.), 78.0 (40.)
 Trefferlage: 0.36 mm links, 0.01 mm tief
 Streuwert: 1.08, horizontal: 1.21, vertikal: 0.93



Ergebnis: 417.4 (399)
Serien: 103.4 105.7 103.7 104.6
Zähler: 39 1 0 0 0 0 0 0 0 0
Innenzehner: 36
Weiteste: 284 (22.), 205 (1.), 204 (10.)
beste Teiler: 9.8 (38.), 10.4 (15.), 38.0 (18.)
Trefferlage: 0.09 mm rechts, 0.13 mm tief
Streuwert: 1.00, horizontal: 0.89, vertikal: 1.11

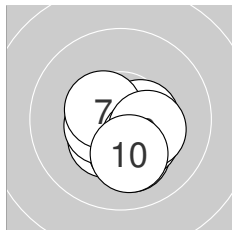
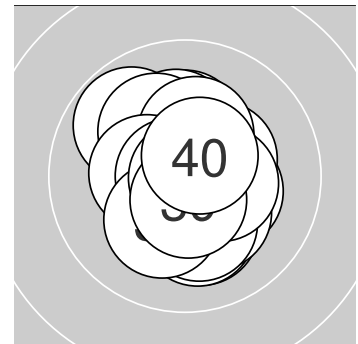

Serie 1: 103.4 (100)

10.1 ↓	10.4* ↙	10.3* ↓	10.5* ←	10.4* ↘
10.5* →	10.5* ↘	10.3* ↘	10.3* →	10.1 ↓

beste Teiler: 109.4 (4.), 114.1 (7.), 115.0 (6.)
Trefferlage: 0.37 mm rechts, 0.89 mm tief
Streuwert: 0.92, horizontal: 0.98, vertikal: 0.85

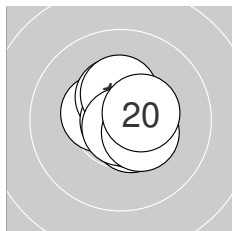

Serie 2: 105.7 (100)

10.7* →	10.4* ←	10.6* ↘	10.4* ↑	10.9* ←
10.3* ↑	10.7* ↘	10.8* ↓	10.4* ↘	10.5* →

beste Teiler: 10.4 (15.), 38.0 (18.), 71.4 (17.)
Trefferlage: 0.24 mm rechts, 0.13 mm hoch
Streuwert: 0.77, horizontal: 0.74, vertikal: 0.80

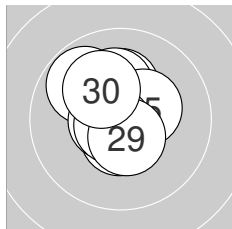

Serie 3: 103.7 (99)

10.2* ↑	9.8 ↘	10.2* ↑	10.7* ←	10.4* ↘
10.5* ↓	10.6* ←	10.7* ↙	10.5* ↓	10.1 ↘

beste Teiler: 54.1 (24.), 56.6 (28.), 79.6 (27.)
Trefferlage: 0.37 mm links, 0.56 mm hoch
Streuwert: 1.06, horizontal: 0.89, vertikal: 1.21

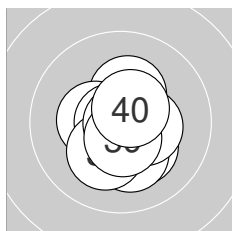

Serie 4: 104.6 (100)

10.3* ↑	10.2* ↘	10.4* ←	10.8* ←	10.2* ↓
10.2* ↙	10.4* →	10.9* ↘	10.6* ↓	10.6* ↗

beste Teiler: 9.8 (38.), 44.0 (34.), 91.9 (39.)
Trefferlage: 0.14 mm rechts, 0.36 mm tief
Streuwert: 0.99, horizontal: 0.87, vertikal: 1.09



Ergebnis: 418.3 (398)
Serien: 105.5 102.8 104.3 105.7
Zähler: 39 0 1 0 0 0 0 0 0 0 0
Innenzehner: 34
Weiteste: 554 (16.), 246 (28.), 227 (26.)
beste Teiler: 34.0 (5.), 36.0 (25.), 39.4 (23.)
Trefferlage: 0.19 mm links, 0.16 mm tief
Streuwert: 1.07, horizontal: 1.18, vertikal: 0.94

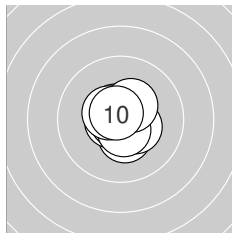
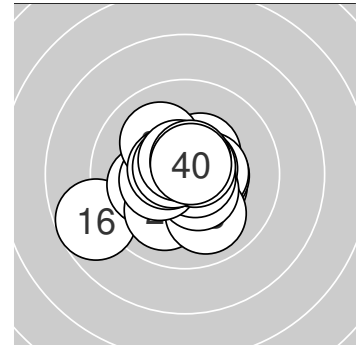

Serie 1: 105.5 (100)

10.5* ↗	10.4* ↓	10.6* ←	10.4* →	10.8* ↙
10.6* ↘	10.6* ↓	10.5* ↖	10.4* ↗	10.7* ↘

beste Teiler: 34.0 (5.), 63.2 (10.), 77.8 (3.)
Trefferlage: 0.04 mm rechts, 0.06 mm hoch
Streuwert: 0.78, horizontal: 0.72, vertikal: 0.84

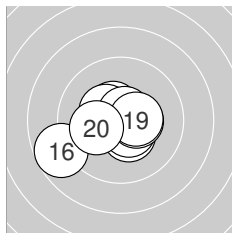

Serie 2: 102.8 (98)

10.5* ↘	10.7* ↓	10.4* ↖	10.4* ↓	10.5* ↘
8.7 ↙	10.7* ↗	10.4* →	10.4* →	10.1 ←

beste Teiler: 57.7 (12.), 65.0 (17.), 107.9 (15.)
Trefferlage: 0.42 mm links, 0.34 mm tief
Streuwert: 1.54, horizontal: 1.91, vertikal: 1.05

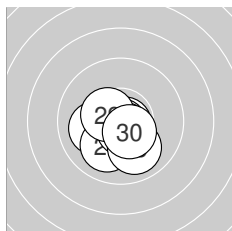

Serie 3: 104.3 (100)

10.6* ↙	10.1 ←	10.8* ↘	10.3* ↓	10.8* ↓
10.0 ↙	10.7* ↓	10.0 ↓	10.5* ↖	10.5* ↘

beste Teiler: 36.0 (25.), 39.4 (23.), 69.8 (27.)
Trefferlage: 0.15 mm links, 0.84 mm tief
Streuwert: 0.92, horizontal: 1.02, vertikal: 0.81

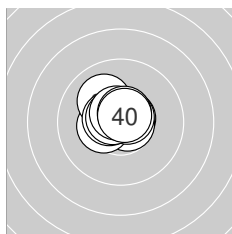

Serie 4: 105.7 (100)

10.7* ↗	10.7* →	10.4* ←	10.7* ↗	10.1 ↘
10.6* ↖	10.6* ↖	10.6* ↘	10.6* ↗	10.7* ↗

beste Teiler: 59.2 (32.), 65.0 (40.), 68.6 (34.)
Trefferlage: 0.23 mm links, 0.47 mm hoch
Streuwert: 0.71, horizontal: 0.82, vertikal: 0.57



Ergebnis: **408.8** (389)
 Serien: 102.2 100.8 101.6 104.2
 Zähler: 30 9 1 0 0 0 0 0 0 0
 Innenzehner: 24
 Weitestе: 506 (19.), 387 (2.), 359 (24.)
 beste Teiler: 34.1 (23.), 46.6 (31.), 63.8 (40.)
 Trefferlage: 0.11 mm links, 0.19 mm hoch
 Streuwert: 1.52, horizontal: 1.43, vertikal: 1.61

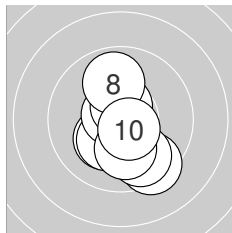
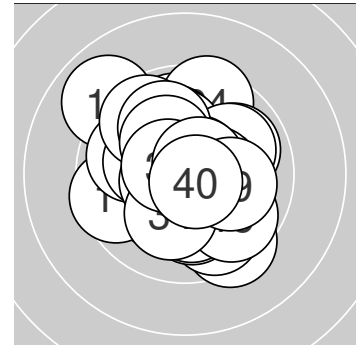

Serie 1: 102.2 (97)

10.2* ↙	9.4 ↘	10.6* ↓	9.8 ↘	10.3* ↙
10.7* ↖	10.6* ↑	9.9 ↑	10.1 ↓	10.6* ↘

beste Teiler: 68.0 (6.), 80.5 (3.), 92.9 (10.)
 Trefferlage: 0.15 mm rechts, 0.84 mm tief
 Streuwert: 1.44, horizontal: 1.05, vertikal: 1.75

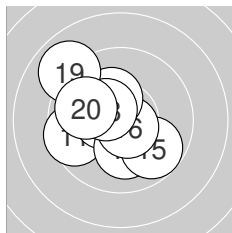

Serie 2: 100.8 (95)

9.6 ←	10.5* ←	10.6* ↘	10.1 ↓	9.8 ↘
10.7* ↘	10.3* ↑	10.4* ↖	8.9 ↖	9.9 ↖

beste Teiler: 70.7 (16.), 98.3 (13.), 121.9 (12.)
 Trefferlage: 0.89 mm links, 0.04 mm hoch
 Streuwert: 1.78, horizontal: 1.87, vertikal: 1.70

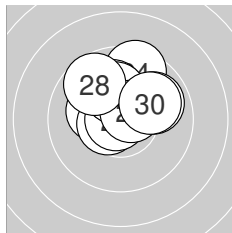

Serie 3: 101.6 (97)

10.2* ↖	10.6* ←	10.8* ←	9.5 ↑	10.1 ↑
10.2* ↑	10.6* ↗	9.7 ↘	9.9 ↗	10.0 ↗

beste Teiler: 34.1 (23.), 93.6 (27.), 97.7 (22.)
 Trefferlage: 0.05 mm rechts, 1.30 mm hoch
 Streuwert: 1.33, horizontal: 1.47, vertikal: 1.18

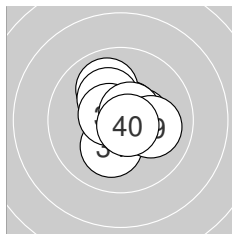

Serie 4: 104.2 (100)

10.8* ↗	10.6* ↗	10.0 ↘	10.2* ↓	10.4* →
10.2* ↘	10.6* ↖	10.6* ↗	10.1 →	10.7* ↘

beste Teiler: 46.6 (31.), 63.8 (40.), 79.9 (32.)
 Trefferlage: 0.22 mm rechts, 0.29 mm hoch
 Streuwert: 1.09, horizontal: 1.06, vertikal: 1.12



Ergebnis: **409.5** (387)
 Serien: 102.2 103.2 100.2 103.9
 Zähler: 27 13 0 0 0 0 0 0 0 0
 Innenezehner: 23
 Weitestе: 456 (24.), 307 (25.), 302 (21.)
 beste Teiler: 28.0 (17.), 38.0 (3.), 56.7 (20.)
 Trefferlage: 0.20 mm links, 0.17 mm hoch
 Streuwert: 1.43, horizontal: 1.73, vertikal: 1.06

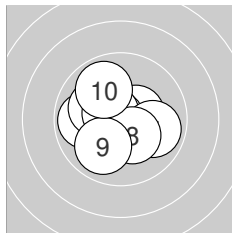
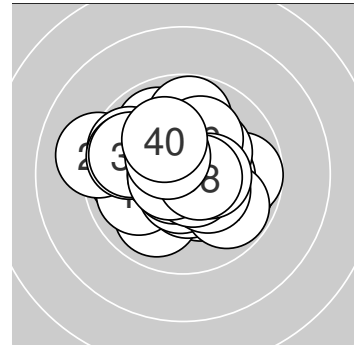

Serie 1: 102.2 (96)

10.4* ↖	10.4* →	10.8* ←	9.9 ←	10.1 ↖
10.6* ↖	9.9 →	10.3* ↘	9.9 ↗	9.9 ↖

beste Teiler: 38.0 (3.), 93.2 (6.), 127.8 (2.)
 Trefferlage: 0.45 mm links, 0.09 mm hoch
 Streuwert: 1.43, horizontal: 1.58, vertikal: 1.26

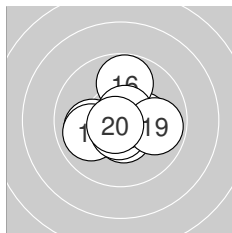

Serie 2: 103.2 (97)

10.5* ↓	10.0 ←	10.3* →	9.9 ←	10.6* ↓
9.8 ↑	10.8* →	10.7* ↗	9.9 →	10.7* ↗

beste Teiler: 28.0 (17.), 56.7 (20.), 60.4 (18.)
 Trefferlage: 0.03 mm rechts, 0.09 mm tief
 Streuwert: 1.35, horizontal: 1.52, vertikal: 1.16

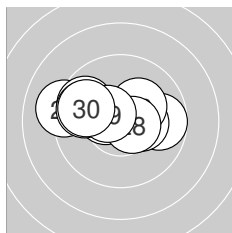

Serie 3: 100.2 (95)

9.7 →	10.3* →	10.5* ←	9.1 ←	9.7 ↖
10.2* ↗	9.8 ↖	10.6* →	10.5* ↖	9.8 ↖

beste Teiler: 96.4 (28.), 117.3 (29.), 124.5 (23.)
 Trefferlage: 0.80 mm links, 0.59 mm hoch
 Streuwert: 1.77, horizontal: 2.43, vertikal: 0.58

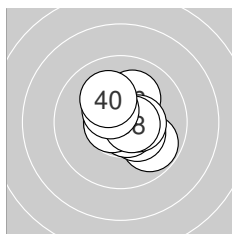

Serie 4: 103.9 (99)

9.8 ↘	10.3* ↘	10.7* ←	10.7* ↘	10.7* ←
10.1 ↗	10.4* →	10.6* →	10.5* ↖	10.1 ↖

beste Teiler: 67.9 (35.), 68.0 (33.), 75.6 (34.)
 Trefferlage: 0.41 mm rechts, 0.11 mm hoch
 Streuwert: 1.13, horizontal: 1.13, vertikal: 1.12



Ergebnis: 403.9 (389)
Serien: 100.9 101.0 101.2 100.8
Zähler: 29 11 0 0 0 0 0 0 0 0
Innenzehner: 17
Weiteste: 409 (39.), 376 (17.), 333 (36.)
beste Teiler: 53.8 (13.), 85.8 (32.), 88.0 (25.)
Trefferlage: 0.56 mm links, 0.20 mm hoch
Streuwert: 1.58, horizontal: 1.74, vertikal: 1.40

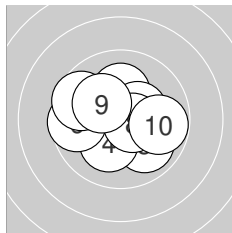
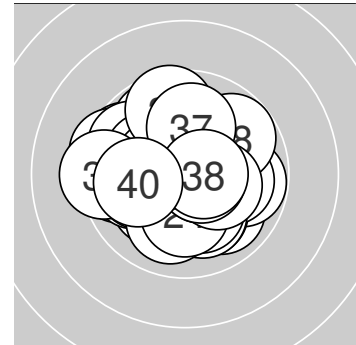

Serie 1: 100.9 (96)

10.4* ↑	10.2* ↑	9.9 ↘	10.2* ↙	10.4* →
9.6 ←	9.6 ↖	10.6* →	10.2* ↘	9.8 →

beste Teiler: 93.9 (8.), 142.6 (5.), 143.4 (1.)
Trefferlage: 0.19 mm links, 0.22 mm hoch
Streuwert: 1.70, horizontal: 2.01, vertikal: 1.33

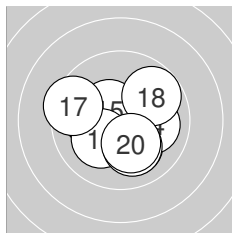

Serie 2: 101.0 (98)

10.1 ←	10.1 ↘	10.7* ↗	10.0 →	10.5* ↘
10.1 ↙	9.4 ↖	9.8 ↗	10.1 ↘	10.2* ↘

beste Teiler: 53.8 (13.), 119.5 (15.), 190.6 (20.)
Trefferlage: 0.04 mm links, 0.29 mm tief
Streuwert: 1.69, horizontal: 1.94, vertikal: 1.38

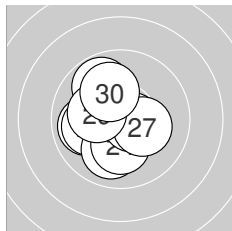

Serie 3: 101.2 (98)

9.9 ←	10.0 ←	10.0 ↓	10.2* ↓	10.6* →
10.1 ↘	10.3* →	9.8 ↘	10.2* ↖	10.1 ↖

beste Teiler: 88.0 (25.), 174.2 (27.), 185.0 (29.)
Trefferlage: 0.80 mm links, 0.08 mm hoch
Streuwert: 1.49, horizontal: 1.33, vertikal: 1.63

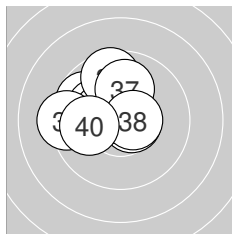

Serie 4: 100.8 (97)

9.7 ↖	10.6* →	10.1 ↖	10.5* ↖	10.4* ↖
9.6 ↑	10.0 ↑	10.6* →	9.3 ←	10.0 ←

beste Teiler: 85.8 (32.), 94.0 (38.), 122.0 (34.)
Trefferlage: 1.20 mm links, 0.82 mm hoch
Streuwert: 1.42, horizontal: 1.61, vertikal: 1.19

