

Ergebnis: 409.7 (393)
Serien: 102.7 102.0 101.2 103.8
Zähler: 34 5 1 0 0 0 0 0 0 0
Innenzehner: 27
Weiteste: 569 (30.), 373 (17.), 359 (5.)
beste Teiler: 29.0 (9.), 49.6 (34.), 71.1 (3.)
Trefferlage: 0.03 mm links, 0.31 mm hoch
Streuwert: 1.45, horizontal: 1.67, vertikal: 1.19

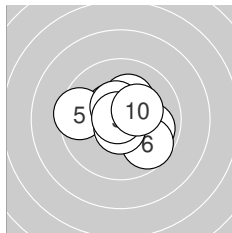
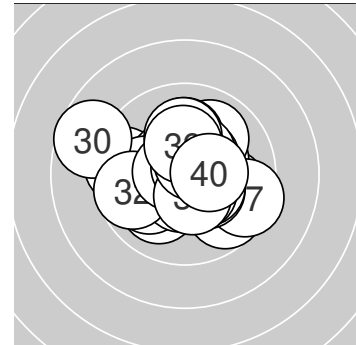

Serie 1: 102.7 (97)

10.2* ↗	9.9 ↘	10.7* ↑	10.5* ↖	9.5 ←
9.7 ↘	10.5* ↗	10.6* ↓	10.8* ↖	10.3* ↗

beste Teiler: 29.0 (9.), 71.1 (3.), 77.3 (8.)
Trefferlage: 0.18 mm rechts, 0.21 mm hoch
Streuwert: 1.46, horizontal: 1.74, vertikal: 1.11

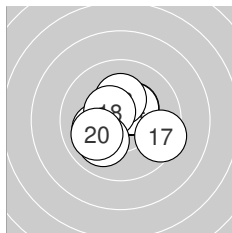

Serie 2: 102.0 (99)

10.5* ↖	10.4* ↗	10.4* ↗	10.4* ↗	10.1 ←
10.2* ↑	9.5 ↘	10.5* ↖	10.0 ↗	10.0 ↗

beste Teiler: 110.0 (11.), 120.4 (18.), 129.4 (12.)
Trefferlage: 0.09 mm links, 0.08 mm hoch
Streuwert: 1.51, horizontal: 1.74, vertikal: 1.24

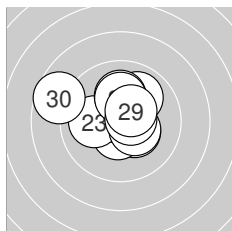

Serie 3: 101.2 (98)

10.3* ↘	10.5* ↓	10.0 ←	10.0 ↗	10.4* ↘
10.1 ↑	10.2* ↑	10.6* →	10.4* ↗	8.7 ↖

beste Teiler: 90.4 (28.), 112.5 (22.), 127.2 (29.)
Trefferlage: 0.21 mm links, 0.64 mm hoch
Streuwert: 1.76, horizontal: 2.10, vertikal: 1.34

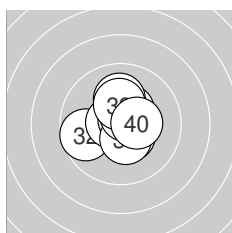

Serie 4: 103.8 (99)

10.5* ↘	9.7 ←	10.6* ←	10.8* ↗	10.4* ↗
10.4* ↘	10.1 ↑	10.6* ↗	10.3* ↑	10.4* →

beste Teiler: 49.6 (34.), 80.4 (33.), 86.6 (38.)
Trefferlage: 0.00 mm , 0.32 mm hoch
Streuwert: 1.19, horizontal: 1.21, vertikal: 1.16



Ergebnis: **402.9** (386)
 Serien: 99.1 103.4 100.1 100.3
 Zähler: 27 12 1 0 0 0 0 0 0 0
 Innenzehner: 18
 Weitestе: 628 (27.), 500 (4.), 449 (9.)
 beste Teiler: 54.1 (18.), 67.2 (16.), 74.6 (3.)
 Trefferlage: 0.12 mm rechts, 0.64 mm tief
 Streuwert: 1.74, horizontal: 2.19, vertikal: 1.11

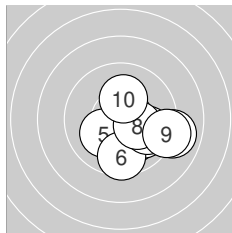
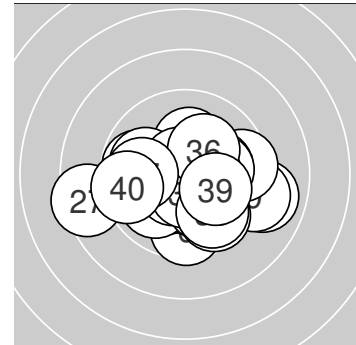

Serie 1: 99.1 (96)

10.1 ↘	10.0 ↘	10.7* ↗	9.0 →	10.1 ✓
9.6 ↓	9.9 ↘	10.3* ↘	9.2 →	10.2* ↑

beste Teiler: 74.6 (3.), 166.6 (8.), 191.7 (10.)
 Trefferlage: 1.59 mm rechts, 0.98 mm tief
 Streuwert: 1.69, horizontal: 1.94, vertikal: 1.40

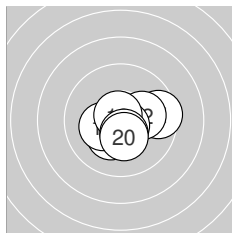

Serie 2: 103.4 (99)

9.5 →	10.1 →	10.5* ↓	10.5* ←	10.3* ✓
10.7* ↘	10.3* ←	10.7* ↘	10.5* ↓	10.3* ↓

beste Teiler: 54.1 (18.), 67.2 (16.), 102.4 (14.)
 Trefferlage: 0.24 mm rechts, 0.53 mm tief
 Streuwert: 1.22, horizontal: 1.52, vertikal: 0.81

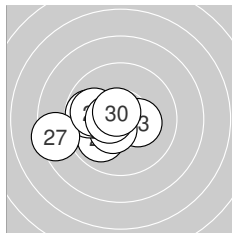

Serie 3: 100.1 (95)

10.0 ←	9.9 ✓	10.3* →	10.5* ✓	10.1 ←
9.8 ←	8.4 ←	9.9 ←	10.5* ←	10.7* ↘

beste Teiler: 75.6 (30.), 104.0 (29.), 119.2 (24.)
 Trefferlage: 1.82 mm links, 0.28 mm tief
 Streuwert: 1.55, horizontal: 1.99, vertikal: 0.91

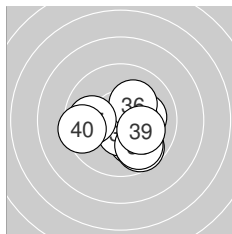

Serie 4: 100.3 (96)

10.1 ↘	9.7 ↘	10.1 →	10.4* →	10.5* ↓
10.2* ↗	9.9 ←	9.8 ↘	10.1 ↘	9.5 ←

beste Teiler: 111.1 (35.), 128.0 (34.), 189.6 (36.)
 Trefferlage: 0.48 mm rechts, 0.78 mm tief
 Streuwert: 1.68, horizontal: 2.00, vertikal: 1.27



Ergebnis: 417.3 (398)
Serien: 103.5 104.8 104.9 104.1
Zähler: 38 2 0 0 0 0 0 0 0 0 0
Innenzehner: 33
Weiteste: 255 (8.), 251 (40.), 226 (6.)
beste Teiler: 24.0 (27.), 36.3 (1.), 43.2 (38.)
Trefferlage: 0.22 mm links, 0.08 mm hoch
Streuwert: 1.02, horizontal: 1.04, vertikal: 1.01

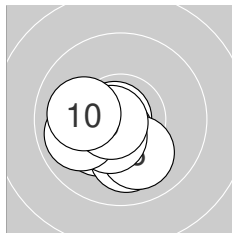
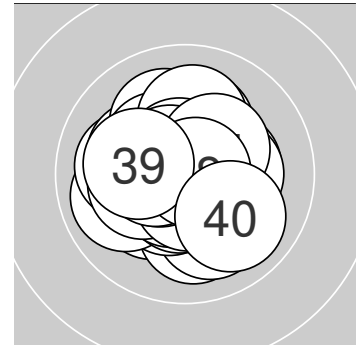

Serie 1: 103.5 (99)

10.8* ←	10.6* ↓	10.2* ↘	10.1 ↓	10.6* ↘
10.0 ↓	10.5* ↘	9.9 ←	10.7* ←	10.1 ←

beste Teiler: 36.3 (1.), 61.0 (9.), 84.8 (5.)
Trefferlage: 0.69 mm links, 0.87 mm tief
Streuwert: 0.94, horizontal: 1.05, vertikal: 0.82

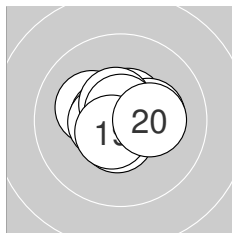

Serie 2: 104.8 (100)

10.2* ↖	10.6* ←	10.6* ↓	10.5* ↑	10.6* ←
10.3* →	10.5* ↑	10.7* ↑	10.6* ↘	10.2* →

beste Teiler: 55.1 (18.), 85.1 (12.), 90.0 (19.)
Trefferlage: 0.06 mm links, 0.19 mm hoch
Streuwert: 0.91, horizontal: 1.11, vertikal: 0.65

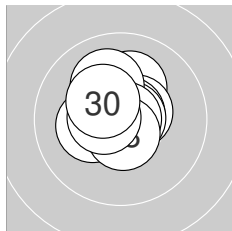

Serie 3: 104.9 (100)

10.2* ↑	10.3* ←	10.5* ↗	10.7* ↗	10.8* →
10.1 ↑	10.9* →	10.6* ↓	10.5* ←	10.3* ↖

beste Teiler: 24.0 (27.), 50.4 (25.), 55.2 (24.)
Trefferlage: 0.17 mm links, 0.47 mm hoch
Streuwert: 0.92, horizontal: 0.89, vertikal: 0.94

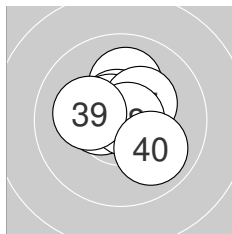

Serie 4: 104.1 (99)

10.4* ↑	10.1 ↑	10.7* ↑	10.5* ←	10.6* ↑
10.6* ↖	10.3* ↗	10.8* →	10.2* ←	9.9 ↓

beste Teiler: 43.2 (38.), 69.3 (33.), 81.3 (36.)
Trefferlage: 0.04 mm rechts, 0.54 mm hoch
Streuwert: 1.05, horizontal: 1.09, vertikal: 1.00



Ergebnis: **396.6** (378)
 Serien: 99.2 97.4 98.7 101.3
 Zähler: 18 22 0 0 0 0 0 0 0 0
 Innenzehner: 11
 Weitester: 475 (17.), 472 (15.), 456 (6.)
 beste Teiler: 77.0 (35.), 85.4 (4.), 88.0 (11.)
 Trefferlage: 0.77 mm rechts, 1.13 mm hoch
 Streuwert: 1.74, horizontal: 2.13, vertikal: 1.24

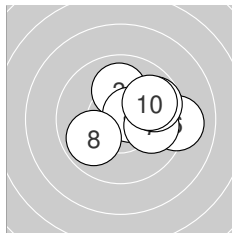
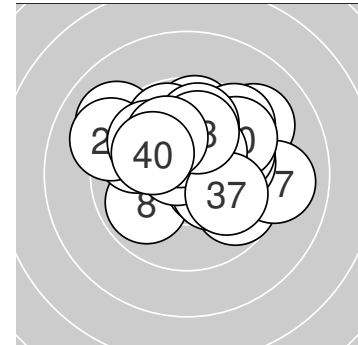

Serie 1: 99.2 (93)

10.5* ↗	9.9 →	10.0 ↑	10.6* ↗	9.7 →
9.1 →	9.9 →	9.9 ↙	9.7 →	9.9 ↗

beste Teiler: 85.4 (4.), 107.6 (1.), 233.3 (3.)
 Trefferlage: 1.67 mm rechts, 0.54 mm hoch
 Streuwert: 1.56, horizontal: 1.92, vertikal: 1.09

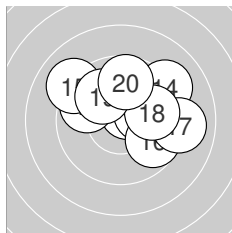

Serie 2: 97.4 (93)

10.6* ↗	9.8 ↖	10.3* →	9.2 ↗	9.1 ↖
9.7 ↘	9.1 →	9.9 →	10.0 ↖	9.7 ↑

beste Teiler: 88.0 (11.), 175.8 (13.), 243.2 (19.)
 Trefferlage: 0.81 mm rechts, 1.14 mm hoch
 Streuwert: 2.24, horizontal: 2.78, vertikal: 1.50

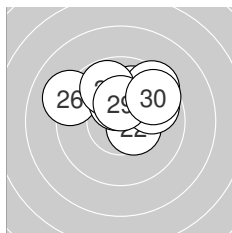

Serie 3: 98.7 (94)

10.0 ↑	10.5* ↘	9.7 ↗	9.5 ↗	9.8 ↗
9.1 ↖	10.3* ↑	9.8 ↘	10.4* ↑	9.6 ↗

beste Teiler: 118.5 (22.), 146.0 (29.), 152.6 (27.)
 Trefferlage: 0.64 mm rechts, 1.74 mm hoch
 Streuwert: 1.65, horizontal: 2.14, vertikal: 0.94

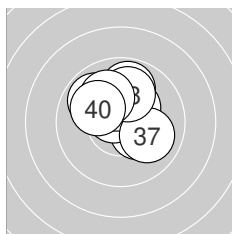

Serie 4: 101.3 (98)

9.8 ↑	9.9 ↖	10.3* ↘	10.3* ↗	10.6* ↖
10.3* ↖	10.0 ↘	10.0 ↑	10.0 ↖	10.1 ↖

beste Teiler: 77.0 (35.), 155.9 (34.), 156.9 (36.)
 Trefferlage: 0.02 mm links, 1.12 mm hoch
 Streuwert: 1.33, horizontal: 1.40, vertikal: 1.25



Ergebnis: **404.3** (387)
 Serien: 104.7 101.1 99.5 99.0
 Zähler: 27 13 0 0 0 0 0 0 0 0
 Innenzehner: 21
 Weitestе: 483 (32.), 444 (29.), 403 (16.)
 beste Teiler: 17.0 (22.), 31.7 (13.), 60.1 (6.)
 Trefferlage: 0.46 mm rechts, 0.50 mm hoch
 Streuwert: 1.68, horizontal: 1.99, vertikal: 1.30

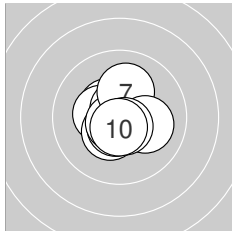
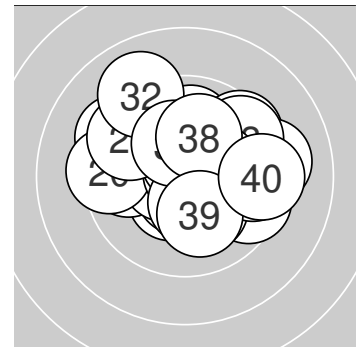

Serie 1: 104.7 (100)

10.5* ↘	10.4* ←	10.7* ↑	10.4* ↙	10.6* ↓
10.7* ↗	10.1 ↑	10.1 →	10.6* ↘	10.6* ↓

beste Teiler: 60.1 (6.), 65.4 (3.), 78.3 (10.)
 Trefferlage: 0.11 mm links, 0.07 mm tief
 Streuwert: 0.96, horizontal: 0.94, vertikal: 0.97

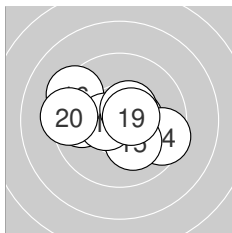

Serie 2: 101.1 (96)

10.5* →	9.8 ←	10.8* ←	9.5 →	10.2* ↘
9.3 ↘	10.5* ←	10.5* ↗	10.6* →	9.4 ←

beste Teiler: 31.7 (13.), 94.2 (19.), 106.6 (17.)
 Trefferlage: 0.46 mm links, 0.05 mm hoch
 Streuwert: 1.82, horizontal: 2.37, vertikal: 1.02

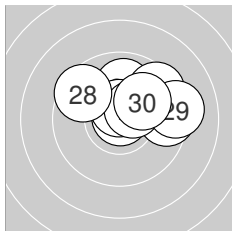

Serie 3: 99.5 (95)

10.0 ↗	10.9* ↑	9.9 ↑	9.5 →	10.6* ↑
10.4* ↗	9.5 ↗	9.5 ↘	9.2 →	10.0 ↗

beste Teiler: 17.0 (22.), 86.1 (25.), 128.6 (26.)
 Trefferlage: 1.23 mm rechts, 1.27 mm hoch
 Streuwert: 1.60, horizontal: 2.10, vertikal: 0.86

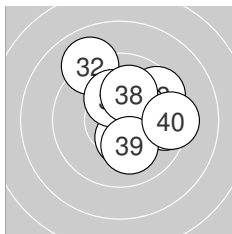

Serie 4: 99.0 (96)

9.5 →	9.0 ↘	9.6 ↗	10.5* ↗	10.4* ↓
10.2* →	10.2* ↑	10.1 ↑	10.1 ↓	9.4 →

beste Teiler: 102.5 (34.), 139.4 (35.), 179.2 (36.)
 Trefferlage: 1.18 mm rechts, 0.76 mm hoch
 Streuwert: 1.87, horizontal: 1.92, vertikal: 1.81



Ergebnis: **414.0** (397)
 Serien: 103.6 104.4 104.4 101.6
 Zähler: 37 3 0 0 0 0 0 0 0 0
 Innenzehner: 29
 Weitester: 350 (40.), 346 (32.), 258 (36.)
 beste Teiler: 54.6 (18.), 55.8 (13.), 56.2 (30.)
 Trefferlage: 0.24 mm rechts, 0.23 mm hoch
 Streuwert: 1.18, horizontal: 1.26, vertikal: 1.10

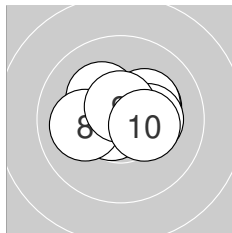
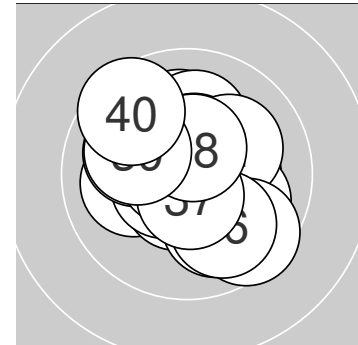

Serie 1: 103.6 (100)

10.3* ↗	10.4* ↖	10.5* →	10.2* ↖	10.7* ↙
10.2* ↗	10.3* →	10.1 ←	10.6* ↑	10.3* →

beste Teiler: 64.6 (5.), 79.0 (9.), 115.9 (3.)
 Trefferlage: 0.20 mm rechts, 0.32 mm hoch
 Streuwert: 1.13, horizontal: 1.46, vertikal: 0.64

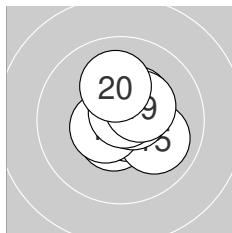

Serie 2: 104.4 (100)

10.5* ↙	10.4* ↗	10.7* ↘	10.5* →	10.0 ↘
10.5* ↙	10.6* ↗	10.7* ↑	10.4* ↗	10.1 ↑

beste Teiler: 54.6 (18.), 55.8 (13.), 86.3 (17.)
 Trefferlage: 0.52 mm rechts, 0.21 mm hoch
 Streuwert: 0.96, horizontal: 0.92, vertikal: 1.00

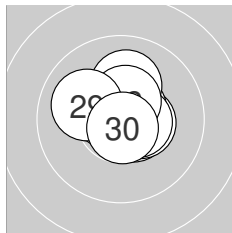

Serie 3: 104.4 (100)

10.2* ↖	10.6* ↘	10.5* →	10.6* ↗	10.5* →
10.1 ↑	10.7* ↖	10.5* ↑	10.0 ↖	10.7* ↓

beste Teiler: 56.2 (30.), 68.4 (27.), 89.1 (24.)
 Trefferlage: 0.00 mm, 0.44 mm hoch
 Streuwert: 0.99, horizontal: 1.13, vertikal: 0.83

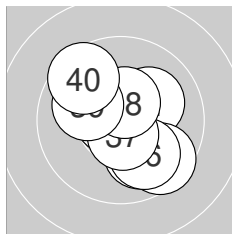

Serie 4: 101.6 (97)

10.1 ↗	9.6 ↘	10.0 ↘	10.6* ↑	10.7* ←
9.9 ↘	10.6* ↓	10.5* ↑	10.0 ↖	9.6 ↘

beste Teiler: 63.7 (35.), 91.0 (37.), 98.7 (34.)
 Trefferlage: 0.24 mm rechts, 0.06 mm tief
 Streuwert: 1.65, horizontal: 1.58, vertikal: 1.72



Ergebnis: **406.8** (390)
 Serien: 102.5 102.1 101.6 100.6
 Zähler: 30 10 0 0 0 0 0 0 0 0 0
 Innenzehner: 25
 Weitestе: 424 (32.), 407 (36.), 402 (18.)
 beste Teiler: 45.5 (24.), 55.1 (33.), 58.1 (5.)
 Trefferlage: 0.10 mm rechts, 0.20 mm tief
 Streuwert: 1.58, horizontal: 1.95, vertikal: 1.10

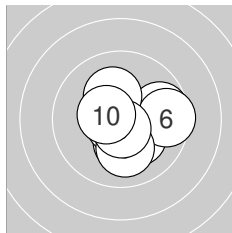
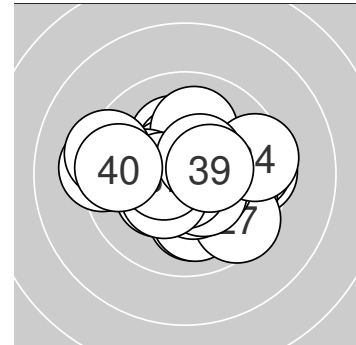

Serie 1: 102.5 (98)

10.7* ↓	10.2* ↓	9.7 →	10.2* ↘	10.7* ↙
9.5 →	10.2* ↑	10.1 ↓	10.7* ↓	10.5* ↖

beste Teiler: 58.1 (5.), 69.0 (1.), 73.5 (9.)
 Trefferlage: 0.62 mm rechts, 0.42 mm tief
 Streuwert: 1.37, horizontal: 1.53, vertikal: 1.19

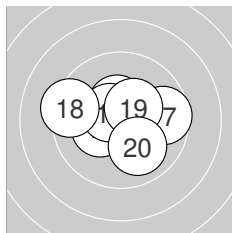

Serie 2: 102.1 (98)

10.6* ↘	10.4* ←	10.5* ↑	10.3* ←	10.5* ↗
10.5* ↖	9.6 →	9.3 ←	10.4* ↗	10.0 ↓

beste Teiler: 84.0 (11.), 101.2 (16.), 123.0 (15.)
 Trefferlage: 0.07 mm links, 0.18 mm hoch
 Streuwert: 1.56, horizontal: 1.97, vertikal: 0.98

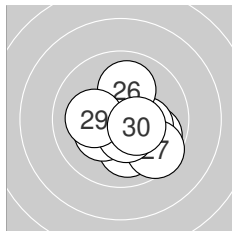

Serie 3: 101.6 (98)

9.8 ↘	10.0 ↓	10.2* →	10.8* ←	10.3* ↙
10.0 ↑	9.5 ↘	10.5* ↓	10.1 ←	10.4* ↘

beste Teiler: 45.5 (24.), 117.1 (28.), 133.9 (30.)
 Trefferlage: 0.58 mm rechts, 0.66 mm tief
 Streuwert: 1.43, horizontal: 1.55, vertikal: 1.30

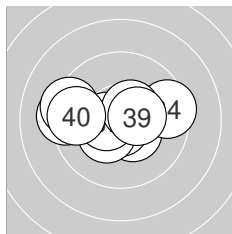

Serie 4: 100.6 (96)

10.4* ↘	9.3 ←	10.7* ↓	9.5 →	10.4* ↙
9.3 ←	10.5* ←	10.5* ↗	10.4* →	9.6 ←

beste Teiler: 55.1 (33.), 108.4 (37.), 113.9 (38.)
 Trefferlage: 0.72 mm links, 0.10 mm hoch
 Streuwert: 1.87, horizontal: 2.54, vertikal: 0.75



Ergebnis: 413.8 (395)
Serien: 103.2 103.6 102.8 104.2
Zähler: 35 5 0 0 0 0 0 0 0 0 0
Innenzehner: 31
Weiteste: 304 (16.), 269 (39.), 268 (25.)
beste Teiler: 47.0 (9.), 47.0 (13.), 48.8 (40.)
Trefferlage: 0.14 mm rechts, 0.05 mm hoch
Streuwert: 1.18, horizontal: 1.31, vertikal: 1.03

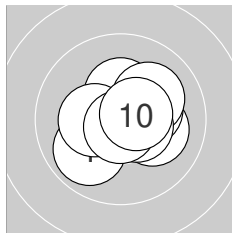
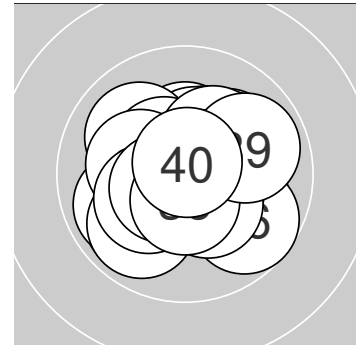

Serie 1: 103.2 (99)

9.9 ↙	10.3* ↗	10.1 →	10.3* ↗	10.3* ↑
10.1 ↗	10.3* ←	10.5* →	10.8* ↓	10.6* ↗

beste Teiler: 47.0 (9.), 100.2 (10.), 106.4 (8.)
Trefferlage: 0.49 mm rechts, 0.11 mm hoch
Streuwert: 1.19, horizontal: 1.35, vertikal: 1.00

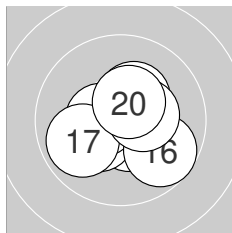

Serie 2: 103.6 (98)

10.5* ↘	10.7* ←	10.8* →	10.3* ↙	10.5* ←
9.7 ↘	9.9 ↙	10.3* ↗	10.4* →	10.5* ↗

beste Teiler: 47.0 (13.), 70.3 (12.), 104.4 (11.)
Trefferlage: 0.05 mm rechts, 0.21 mm tief
Streuwert: 1.24, horizontal: 1.43, vertikal: 1.02

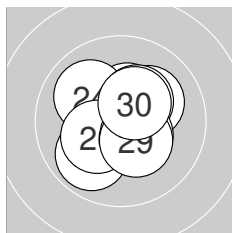

Serie 3: 102.8 (99)

10.1 ↗	10.4* ↑	10.7* ↓	10.0 ↘	9.9 ↙
10.3* ↙	10.3* ↗	10.4* ↘	10.3* ↘	10.4* ↗

beste Teiler: 58.0 (23.), 129.7 (28.), 138.8 (22.)
Trefferlage: 0.07 mm rechts, 0.07 mm hoch
Streuwert: 1.31, horizontal: 1.30, vertikal: 1.31

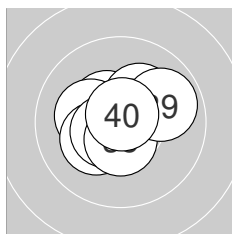

Serie 4: 104.2 (99)

10.5* ↘	10.2* ←	10.7* ↗	10.2* ↗	10.2* ↙
10.7* ↗	10.5* ↙	10.5* ↓	9.9 ↗	10.8* ↑

beste Teiler: 48.8 (40.), 67.6 (33.), 72.4 (36.)
Trefferlage: 0.03 mm links, 0.25 mm hoch
Streuwert: 1.09, horizontal: 1.29, vertikal: 0.85



Ergebnis: 404.9 (388)
Serien: 102.9 99.9 102.1 100.0
Zähler: 28 12 0 0 0 0 0 0 0 0
Innenzehner: 21
Weiteste: 391 (37.), 388 (12.), 348 (22.)
beste Teiler: 61.6 (8.), 83.5 (21.), 86.9 (10.)
Trefferlage: 0.54 mm rechts, 0.18 mm tief
Streuwert: 1.58, horizontal: 1.62, vertikal: 1.53

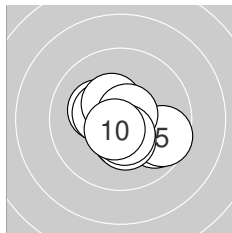
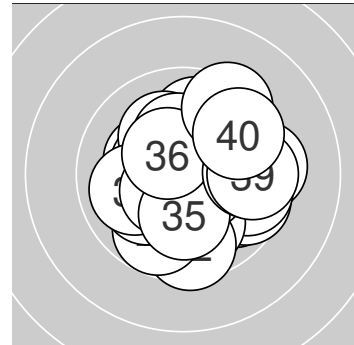

Serie 1: 102.9 (98)

9.8 ↘	10.2* ↖	10.4* ↖	10.4* ↖	9.6 ↘
10.4* ↓	10.3* ↓	10.7* ↗	10.5* ↓	10.6* ↘

beste Teiler: 61.6 (8.), 86.9 (10.), 118.8 (9.)
Trefferlage: 0.28 mm rechts, 0.46 mm tief
Streuwert: 1.29, horizontal: 1.52, vertikal: 1.01

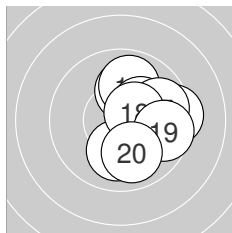

Serie 2: 99.9 (96)

10.1 ↑	9.4 →	9.9 ↑	10.3* ↓	10.2* ↗
10.1 ↓	9.8 →	10.5* ↗	9.6 →	10.0 ↓

beste Teiler: 116.8 (18.), 151.3 (14.), 177.7 (15.)
Trefferlage: 1.48 mm rechts, 0.09 mm hoch
Streuwert: 1.53, horizontal: 1.35, vertikal: 1.70

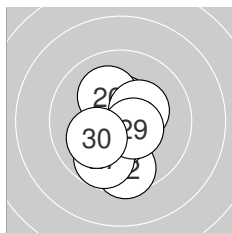

Serie 3: 102.1 (98)

10.6* ↘	9.6 ↓	10.5* ↑	10.5* ↓	10.1 ↘
10.1 ↖	9.8 ↘	10.3* ↗	10.5* ↘	10.1 ↘

beste Teiler: 83.5 (21.), 107.5 (29.), 113.4 (23.)
Trefferlage: 0.16 mm links, 0.76 mm tief
Streuwert: 1.41, horizontal: 1.04, vertikal: 1.70

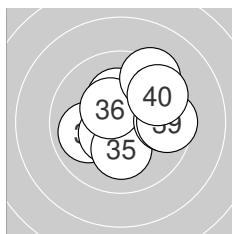

Serie 4: 100.0 (96)

10.3* ↖	10.0 ↖	10.3* ↑	10.5* ↘	10.2* ↓
10.4* ↖	9.4 ↗	9.7 →	9.6 →	9.6 ↗

beste Teiler: 118.8 (34.), 127.2 (36.), 169.5 (31.)
Trefferlage: 0.57 mm rechts, 0.39 mm hoch
Streuwert: 1.87, horizontal: 2.12, vertikal: 1.58



Ergebnis: **403.8** (384)
 Serien: 100.6 103.2 99.5 100.5
 Zähler: 24 16 0 0 0 0 0 0 0 0
 Innenzehner: 21
 Weitest: 395 (3.), 375 (5.), 357 (33.)
 beste Teiler: 56.7 (4.), 86.0 (17.), 94.8 (31.)
 Trefferlage: 0.54 mm links, 0.68 mm tief
 Streuwert: 1.52, horizontal: 1.68, vertikal: 1.34

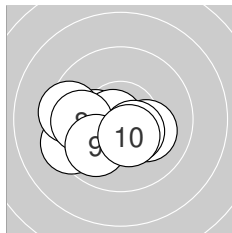
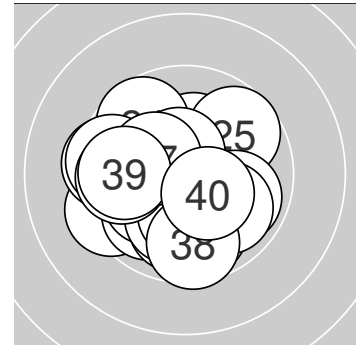

Serie 1: 100.6 (96)

10.2* ←	10.2* ←	9.4 ←	10.7* ←	9.5 ←
10.1 ↘	10.4* ↘	9.8 ←	9.9 ↗	10.4* ↘

beste Teiler: 56.7 (4.), 128.7 (7.), 133.2 (10.)
 Trefferlage: 1.26 mm links, 0.68 mm tief
 Streuwert: 1.46, horizontal: 1.92, vertikal: 0.77

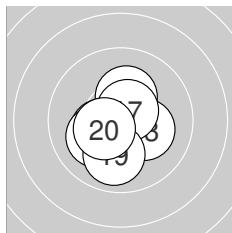

Serie 2: 103.2 (99)

10.5* ↓	10.3* ↑	10.2* ↘	10.5* ←	10.4* ↗
10.3* ←	10.6* ↗	10.1 ←	9.9 ↓	10.4* ↗

beste Teiler: 86.0 (17.), 106.1 (11.), 116.9 (14.)
 Trefferlage: 0.42 mm links, 0.58 mm tief
 Streuwert: 1.09, horizontal: 1.07, vertikal: 1.11

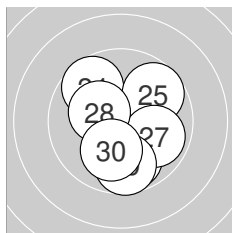

Serie 3: 99.5 (94)

10.2* →	9.9 ↓	9.8 ↓	9.7 ↘	9.7 ↗
10.2* ↓	9.9 ↘	10.3* ←	9.7 ↓	10.1 ↓

beste Teiler: 167.9 (28.), 179.3 (21.), 199.7 (26.)
 Trefferlage: 0.34 mm rechts, 0.82 mm tief
 Streuwert: 1.80, horizontal: 1.55, vertikal: 2.01

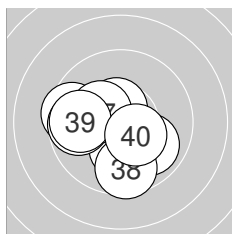

Serie 4: 100.5 (95)

10.6* ↙	10.2* ↓	9.5 ←	9.7 ←	10.5* ↑
9.9 ↘	10.3* ←	9.6 ↓	9.8 ←	10.4* ↘

beste Teiler: 94.8 (31.), 101.5 (35.), 144.0 (40.)
 Trefferlage: 0.82 mm links, 0.63 mm tief
 Streuwert: 1.63, horizontal: 1.86, vertikal: 1.36



Ergebnis: 408.9 (391)
Serien: 102.1 101.9 102.9 102.0
Zähler: 31 9 0 0 0 0 0 0 0 0 0
Innenzehner: 23
Weiteste: 422 (40.), 377 (11.), 308 (22.)
beste Teiler: 33.8 (34.), 35.9 (15.), 51.2 (28.)
Trefferlage: 0.02 mm links, 0.27 mm hoch
Streuwert: 1.44, horizontal: 1.62, vertikal: 1.24

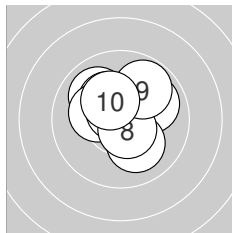
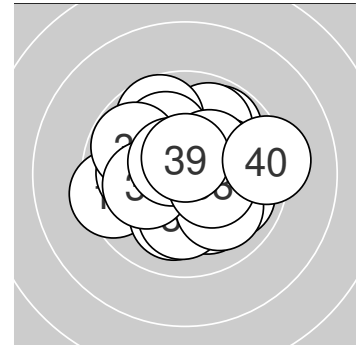

Serie 1: 102.1 (98)

10.0 ↘	10.2* ↗	10.3* ↘	10.2* ↖	10.7* ↘
9.9 ↗	10.1 ↘	10.6* ↘	9.8 ↗	10.3* ↘

beste Teiler: 72.9 (5.), 90.6 (8.), 163.8 (10.)
Trefferlage: 0.17 mm rechts, 0.74 mm hoch
Streuwert: 1.36, horizontal: 1.50, vertikal: 1.22

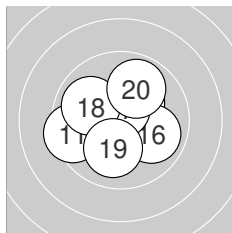

Serie 2: 101.9 (96)

9.4 ←	10.5* ↖	10.5* ↘	10.3* ↗	10.8* →
9.9 →	10.6* ↑	9.9 ↖	10.1 ↓	9.9 ↗

beste Teiler: 35.9 (15.), 88.0 (17.), 119.4 (13.)
Trefferlage: 0.18 mm links, 0.12 mm hoch
Streuwert: 1.59, horizontal: 1.78, vertikal: 1.38

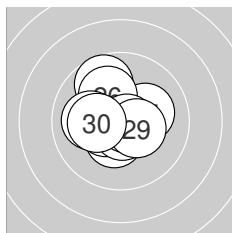

Serie 3: 102.9 (99)

10.4* ↓	9.7 ↘	10.5* ←	10.7* ↓	10.2* →
10.1 ↘	10.0 ←	10.7* →	10.4* →	10.2* ←

beste Teiler: 51.2 (28.), 75.1 (24.), 122.0 (23.)
Trefferlage: 0.42 mm links, 0.21 mm hoch
Streuwert: 1.30, horizontal: 1.33, vertikal: 1.27

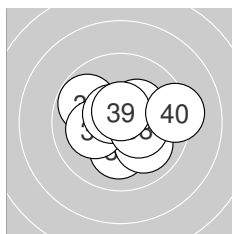

Serie 4: 102.0 (98)

10.1 ↓	9.8 ↖	10.0 ↘	10.8* ↗	10.1 ←
10.6* ↘	10.3* ↗	10.4* →	10.6* ↑	9.3 →

beste Teiler: 33.8 (34.), 83.0 (39.), 91.2 (36.)
Trefferlage: 0.35 mm rechts, 0.00 mm
Streuwert: 1.59, horizontal: 1.92, vertikal: 1.17



Ergebnis: 420.5 (400)
Serien: 104.5 104.7 105.8 105.5
Zähler: 40 0 0 0 0 0 0 0 0 0 0
Innenzehner: 37
Weiteste: 217 (15.), 208 (9.), 204 (4.)
beste Teiler: 7.0 (34.), 27.4 (37.), 60.4 (27.)
Trefferlage: 0.01 mm rechts, 0.06 mm hoch
Streuwert: 0.86, horizontal: 0.83, vertikal: 0.88

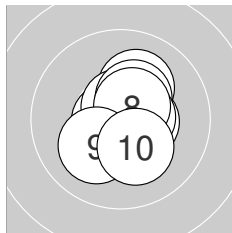
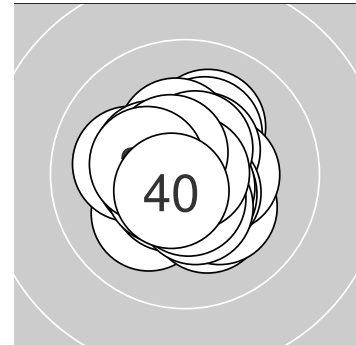

Serie 1: 104.5 (100)

10.5* →	10.7* ←	10.7* ↓	10.1 ↗	10.7* ↑
10.4* ↗	10.6* →	10.5* ↗	10.1 ↖	10.2* ↘

beste Teiler: 63.7 (2.), 69.1 (3.), 71.3 (5.)
Trefferlage: 0.32 mm rechts, 0.06 mm hoch
Streuwert: 0.99, horizontal: 0.83, vertikal: 1.13

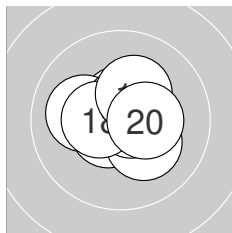

Serie 2: 104.7 (100)

10.6* ↖	10.6* ↑	10.2* ↘	10.7* ↑	10.1 ←
10.7* →	10.6* ↑	10.5* ←	10.3* ↗	10.4* →

beste Teiler: 63.0 (16.), 71.0 (14.), 79.0 (17.)
Trefferlage: 0.02 mm rechts, 0.25 mm hoch
Streuwert: 0.98, horizontal: 1.13, vertikal: 0.80

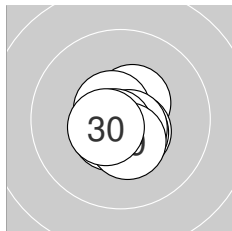

Serie 3: 105.8 (100)

10.5* ↗	10.6* ↓	10.5* ↘	10.6* ↖	10.6* ↘
10.7* ↘	10.7* ↖	10.6* ↖	10.4* ↓	10.6* ↖

beste Teiler: 60.4 (27.), 70.7 (26.), 77.9 (24.)
Trefferlage: 0.04 mm rechts, 0.43 mm tief
Streuwert: 0.64, horizontal: 0.59, vertikal: 0.68

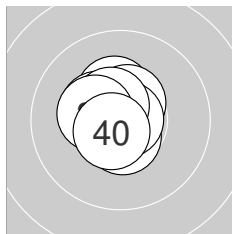

Serie 4: 105.5 (100)

10.6* ↑	10.3* ↑	10.5* ↗	10.9* ←	10.4* ↖
10.6* ↓	10.8* →	10.5* ↘	10.3* ←	10.6* ↖

beste Teiler: 7.0 (34.), 27.4 (37.), 83.8 (40.)
Trefferlage: 0.36 mm links, 0.37 mm hoch
Streuwert: 0.70, horizontal: 0.63, vertikal: 0.77



Ergebnis: **422.5** (400)
 Serien: 105.7 105.5 105.9 105.4
 Zähler: 40 0 0 0 0 0 0 0 0 0
 Innenzehner: 39
 Weitestе: 204 (13.), 185 (30.), 166 (1.)
 beste Teiler: 21.5 (28.), 38.3 (17.), 42.0 (21.)
 Trefferlage: 0.12 mm rechts, 0.01 mm tief
 Streuwert: 0.76, horizontal: 0.80, vertikal: 0.72

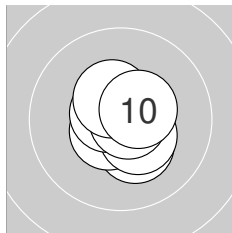
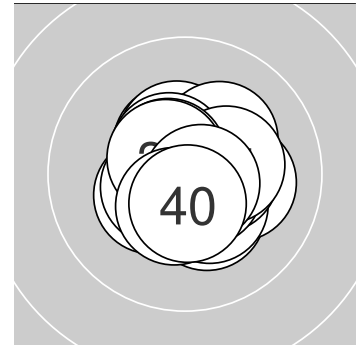

Serie 1: 105.7 (100)

10.3* ↘	10.7* ↘	10.7* ↗	10.7* ↖	10.6* ↗
10.4* ↘	10.6* ↖	10.8* →	10.4* ↖	10.5* ↗

beste Teiler: 44.1 (8.), 55.9 (3.), 75.1 (4.)
 Trefferlage: 0.09 mm rechts, 0.15 mm tief
 Streuwert: 0.76, horizontal: 0.74, vertikal: 0.79

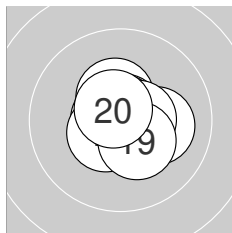

Serie 2: 105.5 (100)

10.6* ↘	10.4* ↑	10.1 →	10.7* ←	10.5* ↗
10.8* ↗	10.8* ↑	10.6* →	10.4* ↘	10.6* ↖

beste Teiler: 38.3 (17.), 44.7 (16.), 62.5 (14.)
 Trefferlage: 0.28 mm rechts, 0.03 mm hoch
 Streuwert: 0.81, horizontal: 0.90, vertikal: 0.71

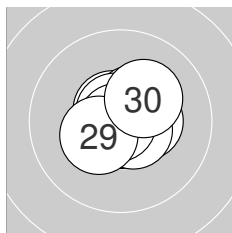

Serie 3: 105.9 (100)

10.8* ↖	10.6* ↖	10.5* ↗	10.4* →	10.8* ↓
10.7* ↖	10.6* ↘	10.9* ←	10.4* ↗	10.2* ↗

beste Teiler: 21.5 (28.), 42.0 (21.), 47.0 (25.)
 Trefferlage: 0.16 mm rechts, 0.19 mm hoch
 Streuwert: 0.76, horizontal: 0.83, vertikal: 0.68

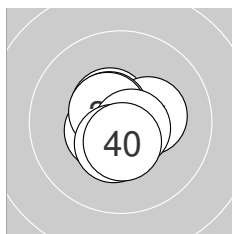

Serie 4: 105.4 (100)

10.7* →	10.5* ↖	10.6* ↓	10.5* ↗	10.3* →
10.6* ↖	10.6* ↖	10.7* ↘	10.4* ↓	10.5* ↓

beste Teiler: 71.1 (38.), 75.3 (31.), 88.3 (33.)
 Trefferlage: 0.05 mm links, 0.14 mm tief
 Streuwert: 0.79, horizontal: 0.81, vertikal: 0.77



Ergebnis: **409.0** (395)
Serien: 102.7 101.2 102.2 102.9
Zähler: 35 5 0 0 0 0 0 0 0 0
Innenzehner: 24
Weiteste: 494 (14.), 277 (23.), 277 (40.)
beste Teiler: 40.4 (16.), 47.2 (29.), 55.3 (15.)
Trefferlage: 0.43 mm rechts, 0.00 mm
Streuwert: 1.38, horizontal: 1.47, vertikal: 1.28

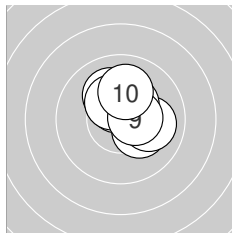
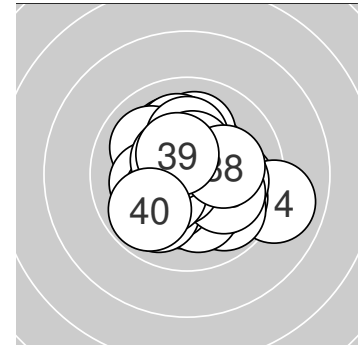

Serie 1: 102.7 (100)

10.3* ↗	10.3* ↘	10.2* ↘	10.1 ↘	10.5* ↗
10.0 →	10.4* ↗	10.3* ↘	10.5* →	10.1 ↗

beste Teiler: 118.1 (5.), 119.6 (9.), 150.4 (7.)
Trefferlage: 0.43 mm rechts, 0.96 mm hoch
Streuwert: 1.04, horizontal: 1.06, vertikal: 1.02

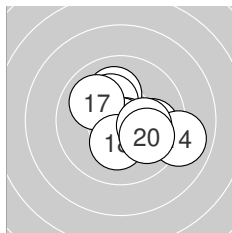

Serie 2: 101.2 (98)

9.9 →	10.1 ↗	10.3* ↘	9.0 →	10.7* ↘
10.8* ↓	10.0 ↘	10.2* ↓	10.2* →	10.0 ↘

beste Teiler: 40.4 (16.), 55.3 (15.), 171.7 (13.)
Trefferlage: 0.80 mm rechts, 0.12 mm tief
Streuwert: 1.70, horizontal: 1.98, vertikal: 1.35

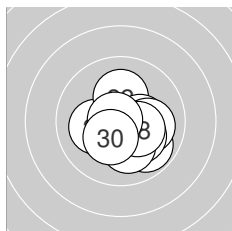

Serie 3: 102.2 (99)

10.1 ←	10.2* ↑	9.8 ↘	10.3* →	10.1 →
10.2* ↘	10.1 ↓	10.3* ↘	10.8* ←	10.3* ↘

beste Teiler: 47.2 (29.), 151.2 (28.), 153.1 (30.)
Trefferlage: 0.60 mm rechts, 0.58 mm tief
Streuwert: 1.27, horizontal: 1.37, vertikal: 1.15

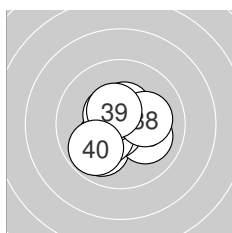

Serie 4: 102.9 (98)

9.9 ↘	10.5* ↗	10.1 ↘	10.5* ↑	10.7* ↘
10.3* ↘	10.5* ↘	10.1 →	10.5* ↘	9.8 ↘

beste Teiler: 66.8 (35.), 111.1 (37.), 119.8 (39.)
Trefferlage: 0.10 mm links, 0.25 mm tief
Streuwert: 1.31, horizontal: 1.41, vertikal: 1.19



Ergebnis: 414.5 (395)
Serien: 104.5 103.7 102.3 104.0
Zähler: 36 3 1 0 0 0 0 0 0 0
Innenzehner: 34
Weiteste: 511 (15.), 388 (21.), 348 (25.)
beste Teiler: 0.0 (29.), 17.4 (16.), 46.3 (8.)
Trefferlage: 0.04 mm rechts, 0.30 mm hoch
Streuwert: 1.24, horizontal: 1.10, vertikal: 1.38

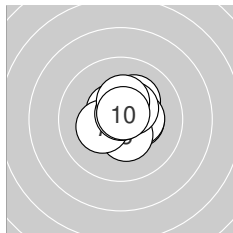
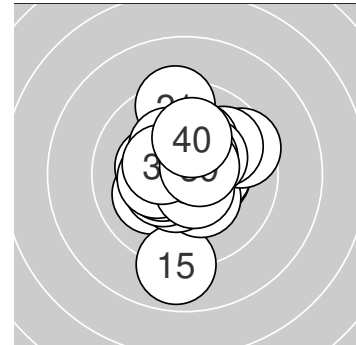

Serie 1: 104.5 (100)

10.2* ↗	10.4* →	10.4* →	10.6* ↖	10.4* ↓
10.4* ↗	10.3* ↖	10.8* ↑	10.3* ↑	10.7* ↑

beste Teiler: 46.3 (8.), 55.5 (10.), 99.9 (4.)
Trefferlage: 0.37 mm rechts, 0.36 mm hoch
Streuwert: 0.92, horizontal: 0.95, vertikal: 0.90

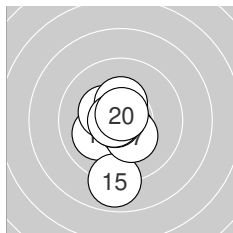

Serie 2: 103.7 (98)

10.1 ↖	10.3* ↖	10.4* ↑	10.6* ↓	8.9 ↓
10.9* ↖	10.3* ↓	10.8* ←	10.7* ←	10.7* ↑

beste Teiler: 17.4 (16.), 46.3 (18.), 51.7 (20.)
Trefferlage: 0.33 mm links, 0.56 mm tief
Streuwert: 1.40, horizontal: 0.82, vertikal: 1.80

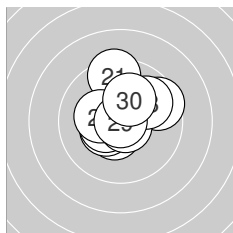

Serie 3: 102.3 (97)

9.4 ↑	10.5* ↓	10.4* ↖	10.4* ←	9.6 →
10.3* ←	10.7* ↓	9.9 ↗	10.9* →	10.2* ↑

beste Teiler: 0.0 (29.), 57.9 (27.), 114.4 (22.)
Trefferlage: 0.12 mm rechts, 0.65 mm hoch
Streuwert: 1.53, horizontal: 1.55, vertikal: 1.51

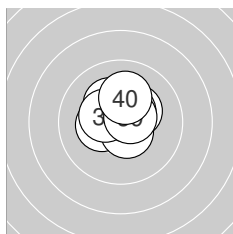

Serie 4: 104.0 (100)

10.2* ↖	10.3* ←	10.6* ↑	10.3* ↗	10.4* ↑
10.6* ↓	10.5* ↗	10.4* ↖	10.6* ↗	10.1 ↑

beste Teiler: 92.5 (39.), 96.7 (36.), 97.7 (33.)
Trefferlage: 0.02 mm rechts, 0.75 mm hoch
Streuwert: 0.90, horizontal: 0.97, vertikal: 0.83



Ergebnis: **414.8** (395)
 Serien: 102.0 105.1 102.8 104.9
 Zähler: 35 5 0 0 0 0 0 0 0 0
 Innenzehner: 29
 Weitester: 370 (4.), 347 (29.), 322 (27.)
 beste Teiler: 16.1 (7.), 33.0 (14.), 40.0 (11.)
 Trefferlage: 0.21 mm links, 0.31 mm tief
 Streuwert: 1.21, horizontal: 1.19, vertikal: 1.22

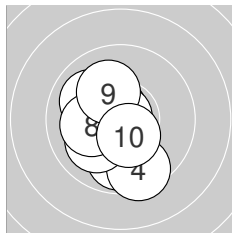
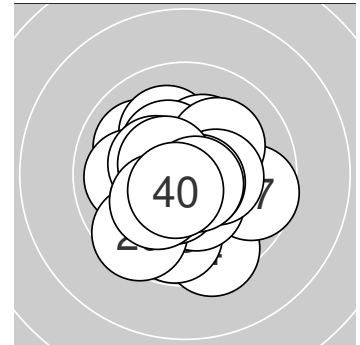

Serie 1: 102.0 (98)

10.5* ↖	10.6* ↖	9.9 ↓	9.5 ↓	10.0 ↗
10.0 ↖	10.9* ↑	10.1 ←	10.1 ↖	10.4* ↘

beste Teiler: 16.1 (7.), 81.6 (2.), 116.3 (1.)
 Trefferlage: 0.64 mm links, 0.47 mm tief
 Streuwert: 1.45, horizontal: 1.10, vertikal: 1.74

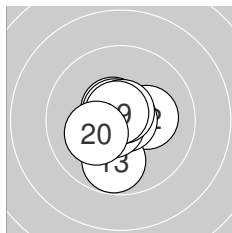

Serie 2: 105.1 (99)

10.8* ↑	10.2* →	9.8 ↓	10.8* →	10.6* ↖
10.6* ↖	10.7* ↗	10.7* ↑	10.7* ↖	10.2* ↗

beste Teiler: 33.0 (14.), 40.0 (11.), 57.7 (19.)
 Trefferlage: 0.17 mm links, 0.09 mm tief
 Streuwert: 1.00, horizontal: 0.89, vertikal: 1.10

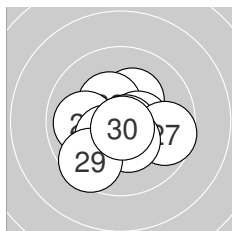

Serie 3: 102.8 (98)

10.3* ↗	10.4* ↖	10.0 ←	10.4* ↗	10.5* →
10.7* ↘	9.7 →	10.4* ↘	9.6 ↗	10.8* ↘

beste Teiler: 50.6 (30.), 53.1 (26.), 123.6 (25.)
 Trefferlage: 0.01 mm links, 0.45 mm tief
 Streuwert: 1.45, horizontal: 1.65, vertikal: 1.22

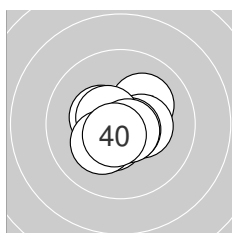

Serie 4: 104.9 (100)

10.5* ↙	10.4* ↖	10.8* ↓	10.1 ↗	10.4* →
10.7* ↘	10.5* ↖	10.7* ↘	10.2* ↗	10.6* ↙

beste Teiler: 41.4 (33.), 68.6 (38.), 69.3 (36.)
 Trefferlage: 0.04 mm links, 0.21 mm tief
 Streuwert: 0.93, horizontal: 1.05, vertikal: 0.79



Ergebnis: **414.8** (396)
 Serien: 102.9 105.0 103.9 103.0
 Zähler: 36 4 0 0 0 0 0 0 0 0
 Innenzehner: 34
 Weitester: 309 (27.), 293 (8.), 275 (34.)
 beste Teiler: 13.0 (14.), 32.0 (35.), 36.2 (17.)
 Trefferlage: 0.03 mm rechts, 0.40 mm tief
 Streuwert: 1.13, horizontal: 1.01, vertikal: 1.23

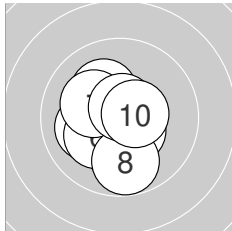
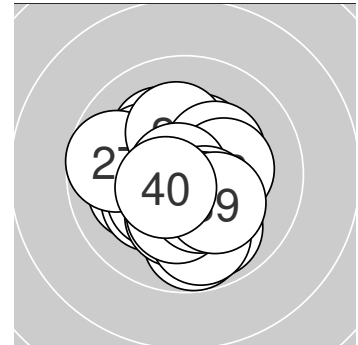

Serie 1: 102.9 (99)

10.6* →	10.1 ↓	10.5* ↘	10.2* ↖	10.1 ←
10.2* ↗	10.2* ↖	9.8 ↓	10.7* ↑	10.5* →

beste Teiler: 68.1 (9.), 78.1 (1.), 105.5 (10.)
 Trefferlage: 0.31 mm links, 0.43 mm tief
 Streuwert: 1.28, horizontal: 1.16, vertikal: 1.39

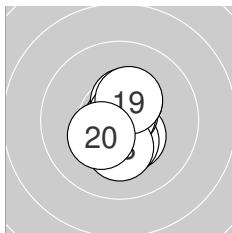

Serie 2: 105.0 (100)

10.4* ↗	10.4* ↘	10.4* ↓	10.9* ←	10.5* ↑
10.7* ↗	10.8* ↗	10.2* ↓	10.4* ↗	10.3* ↗

beste Teiler: 13.0 (14.), 36.2 (17.), 54.6 (16.)
 Trefferlage: 0.18 mm rechts, 0.07 mm tief
 Streuwert: 0.92, horizontal: 0.57, vertikal: 1.17

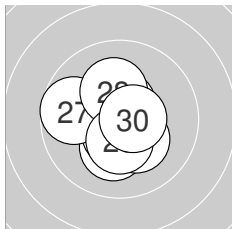

Serie 3: 103.9 (99)

10.5* ←	10.8* ↖	10.2* ↓	10.3* ↘	10.6* ↑
10.6* ↓	9.7 ←	10.2* ↑	10.4* ↓	10.6* →

beste Teiler: 44.8 (22.), 89.0 (30.), 97.3 (25.)
 Trefferlage: 0.34 mm links, 0.17 mm tief
 Streuwert: 1.17, horizontal: 1.15, vertikal: 1.18

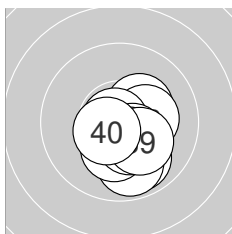

Serie 4: 103.0 (98)

10.3* ↗	9.9 ↓	10.3* →	9.9 ↓	10.8* ←
10.4* ↘	10.3* ↓	10.4* ↘	10.2* ↘	10.5* ↗

beste Teiler: 32.0 (35.), 103.4 (40.), 131.8 (36.)
 Trefferlage: 0.62 mm rechts, 0.95 mm tief
 Streuwert: 1.01, horizontal: 0.86, vertikal: 1.15



Ergebnis: 416.4 (399)
Serien: 105.7 103.8 103.5 103.4
Zähler: 39 1 0 0 0 0 0 0 0 0 0
Innenzehner: 36
Weiteste: 290 (29.), 226 (37.), 224 (22.)
beste Teiler: 33.1 (6.), 41.9 (28.), 49.5 (36.)
Trefferlage: 0.43 mm rechts, 0.05 mm tief
Streuwert: 1.01, horizontal: 0.97, vertikal: 1.06

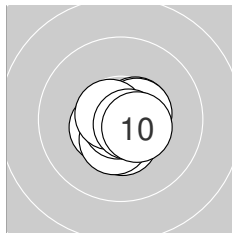
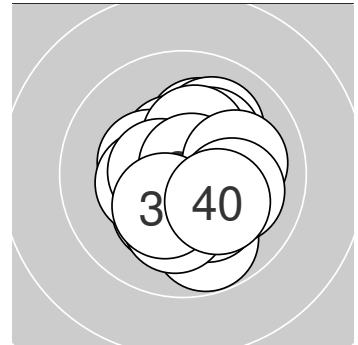

Serie 1: 105.7 (100)

10.5* ↖	10.4* ↓	10.5* →	10.7* ↘	10.4* ↓
10.8* ↙	10.5* →	10.7* ↖	10.7* ↘	10.5* ↘

beste Teiler: 33.1 (6.), 59.3 (9.), 61.2 (4.)
Trefferlage: 0.18 mm rechts, 0.35 mm tief
Streuwert: 0.68, horizontal: 0.74, vertikal: 0.62

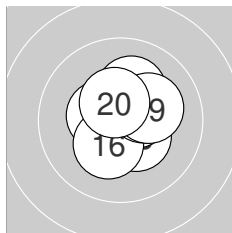

Serie 2: 103.8 (100)

10.5* ↑	10.4* ↗	10.4* ↘	10.5* ↖	10.5* ↗
10.3* ↙	10.3* ↗	10.2* ↑	10.2* →	10.5* ↑

beste Teiler: 104.2 (11.), 107.7 (15.), 118.5 (20.)
Trefferlage: 0.44 mm rechts, 0.49 mm hoch
Streuwert: 1.00, horizontal: 0.99, vertikal: 1.02

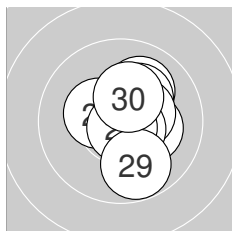

Serie 3: 103.5 (99)

10.4* ↖	10.1 ↗	10.7* ↗	10.2* →	10.2* ↗
10.4* →	10.6* ↘	10.8* ↓	9.8 ↓	10.3* ↑

beste Teiler: 41.9 (28.), 70.0 (23.), 81.8 (27.)
Trefferlage: 0.66 mm rechts, 0.22 mm hoch
Streuwert: 1.14, horizontal: 0.87, vertikal: 1.35

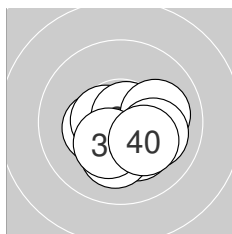

Serie 4: 103.4 (100)

10.3* ↖	10.7* →	10.6* ←	10.2* ↘	10.2* ↓
10.8* ↗	10.0 →	10.3* ↙	10.1 →	10.2* ↘

beste Teiler: 49.5 (36.), 74.6 (32.), 96.6 (33.)
Trefferlage: 0.43 mm rechts, 0.60 mm tief
Streuwert: 1.10, horizontal: 1.29, vertikal: 0.86



Ergebnis: **416.4** (395)
 Serien: 104.0 102.4 105.4 104.6
 Zähler: 36 3 1 0 0 0 0 0 0 0
 Innenzehner: 35
 Weitestе: 505 (12.), 365 (4.), 287 (15.)
 beste Teiler: 5.8 (10.), 26.1 (28.), 28.4 (27.)
 Trefferlage: 0.12 mm links, 0.21 mm hoch
 Streuwert: 1.18, horizontal: 1.39, vertikal: 0.91

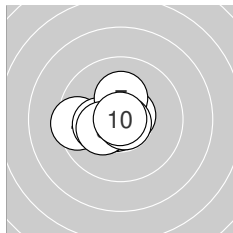
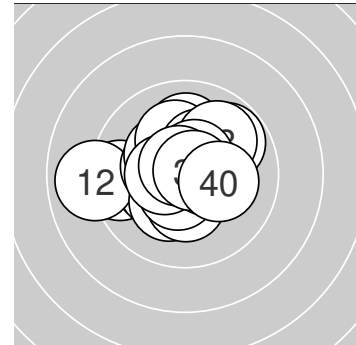

Serie 1: 104.0 (99)

10.7* ↙	10.5* ↙	10.6* →	9.5 ←	10.3* ↙
10.2* ←	10.2* ↑	10.3* ↙	10.8* ↘	10.9* ↘

beste Teiler: 5.8 (10.), 46.6 (9.), 60.9 (1.)
 Trefferlage: 0.86 mm links, 0.13 mm tief
 Streuwert: 1.05, horizontal: 1.29, vertikal: 0.74

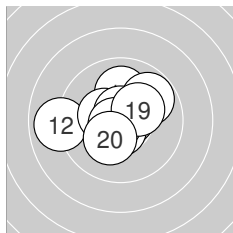

Serie 2: 102.4 (97)

10.0 ↑	8.9 ←	10.7* →	10.4* ←	9.8 ↗
10.6* ↓	10.7* ↑	10.7* ↙	10.3* →	10.3* ↙

beste Teiler: 60.2 (18.), 63.0 (17.), 64.5 (13.)
 Trefferlage: 0.34 mm links, 0.32 mm hoch
 Streuwert: 1.61, horizontal: 1.97, vertikal: 1.15

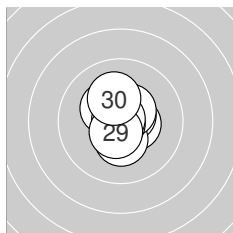

Serie 3: 105.4 (100)

10.3* ↘	10.5* →	10.6* ↗	10.3* ↓	10.8* ↑
10.5* ↗	10.8* ↙	10.8* ↘	10.6* ↙	10.2* ↑

beste Teiler: 26.1 (28.), 28.4 (27.), 50.6 (25.)
 Trefferlage: 0.03 mm rechts, 0.21 mm hoch
 Streuwert: 0.86, horizontal: 0.69, vertikal: 0.99

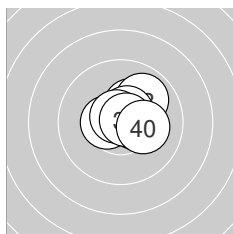

Serie 4: 104.6 (99)

10.3* ↗	10.3* →	9.9 ↗	10.8* ↗	10.5* ←
10.5* →	10.6* ↗	10.7* ↘	10.8* →	10.2* →

beste Teiler: 47.7 (34.), 50.1 (39.), 58.6 (38.)
 Trefferlage: 0.70 mm rechts, 0.46 mm hoch
 Streuwert: 0.85, horizontal: 0.96, vertikal: 0.71



Ergebnis: 413.5 (395)
Serien: 100.9 103.8 104.2 104.6
Zähler: 35 5 0 0 0 0 0 0 0 0 0
Innenzehner: 30
Weiteste: 377 (4.), 361 (8.), 340 (12.)
beste Teiler: 42.4 (40.), 47.4 (13.), 51.2 (24.)
Trefferlage: 0.28 mm links, 0.05 mm hoch
Streuwert: 1.24, horizontal: 1.37, vertikal: 1.10

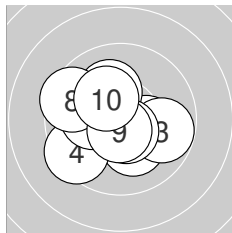
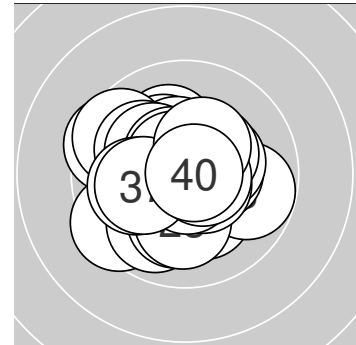

Serie 1: 100.9 (97)

10.2* →	10.2* ↓	9.8 →	9.4 ↙	10.1 ↗
10.6* ↓	10.2* ←	9.5 ↖	10.6* ↓	10.3* ↗

beste Teiler: 76.4 (9.), 90.8 (6.), 173.9 (10.)
Trefferlage: 0.43 mm links, 0.20 mm tief
Streuwert: 1.72, horizontal: 2.00, vertikal: 1.38

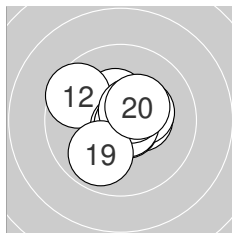

Serie 2: 103.8 (98)

10.4* ↗	9.6 ↖	10.8* ↓	10.4* →	10.7* ↘
10.3* →	10.7* ↘	10.6* ↗	9.9 ↙	10.4* ↗

beste Teiler: 47.4 (13.), 51.4 (17.), 56.5 (15.)
Trefferlage: 0.09 mm rechts, 0.18 mm hoch
Streuwert: 1.26, horizontal: 1.37, vertikal: 1.14

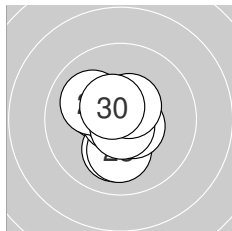

Serie 3: 104.2 (100)

10.3* ↖	10.1 ↓	10.1 ↓	10.7* ←	10.6* ↖
10.6* →	10.1 ↖	10.7* ↓	10.5* ↗	10.5* ↖

beste Teiler: 51.2 (24.), 53.1 (28.), 78.5 (25.)
Trefferlage: 0.40 mm links, 0.08 mm tief
Streuwert: 1.04, horizontal: 0.84, vertikal: 1.21

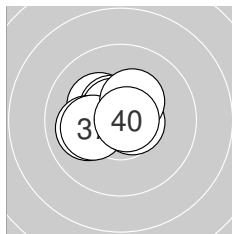

Serie 4: 104.6 (100)

10.2* ↖	10.7* ↑	10.5* ↖	10.6* ↖	10.7* →
10.0 ←	10.2* ←	10.6* →	10.3* ↗	10.8* →

beste Teiler: 42.4 (40.), 69.0 (35.), 73.7 (32.)
Trefferlage: 0.38 mm links, 0.34 mm hoch
Streuwert: 0.94, horizontal: 1.16, vertikal: 0.66



Ergebnis: 401.5 (384)
Serien: 98.9 101.2 99.3 102.1
Zähler: 24 16 0 0 0 0 0 0 0 0
Innenzehner: 15
Weiteste: 403 (3.), 391 (23.), 385 (21.)
beste Teiler: 66.8 (14.), 73.8 (33.), 79.7 (26.)
Trefferlage: 0.13 mm rechts, 0.59 mm tief
Streuwert: 1.72, horizontal: 1.75, vertikal: 1.70

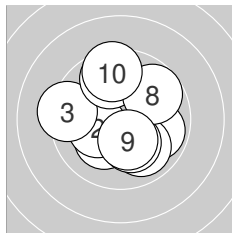
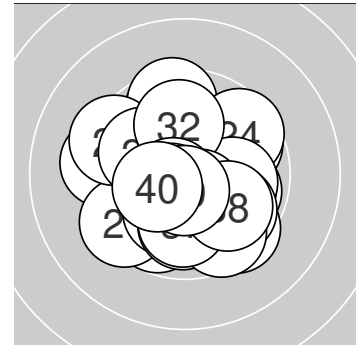

Serie 1: 98.9 (94)

10.2* ↙	10.2* ↖	9.3 ←	9.9 →	9.7 ↑
9.9 ↘	10.2* ↗	9.7 ↗	10.3* ↓	9.5 ↑

beste Teiler: 164.1 (9.), 182.2 (2.), 192.0 (7.)
Trefferlage: 0.05 mm links, 0.07 mm hoch
Streuwert: 2.05, horizontal: 2.03, vertikal: 2.07

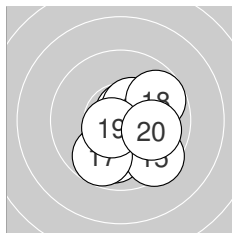

Serie 2: 101.2 (97)

10.0 ↓	10.5* ↘	10.0 ↓	10.7* ↗	9.5 ↘
10.4* ↗	9.8 ↙	9.7 ↗	10.6* ↖	10.0 →

beste Teiler: 66.8 (14.), 87.9 (19.), 122.8 (12.)
Trefferlage: 0.61 mm rechts, 0.90 mm tief
Streuwert: 1.53, horizontal: 1.50, vertikal: 1.56

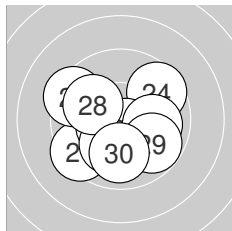

Serie 3: 99.3 (95)

9.4 ↖	10.5* ↖	9.4 ↖	9.6 ↗	10.1 ↙
10.6* ↘	10.0 →	10.0 ↖	9.8 ↘	9.9 ↓

beste Teiler: 79.7 (26.), 122.5 (22.), 204.0 (25.)
Trefferlage: 0.28 mm links, 0.53 mm tief
Streuwert: 1.98, horizontal: 2.25, vertikal: 1.66

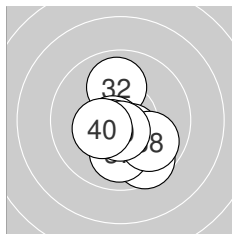

Serie 4: 102.1 (98)

10.0 ↘	10.0 ↑	10.7* ↖	9.6 ↓	10.5* ↘
10.5* ↖	10.0 ↓	9.9 ↘	10.6* ↓	10.3* ↖

beste Teiler: 73.8 (33.), 82.0 (39.), 101.8 (36.)
Trefferlage: 0.28 mm rechts, 1.01 mm tief
Streuwert: 1.33, horizontal: 1.16, vertikal: 1.48



Ergebnis: 410.5 (393)
Serien: 100.8 103.3 103.4 103.0
Zähler: 33 7 0 0 0 0 0 0 0 0
Innenzehner: 26
Weiteste: 406 (6.), 363 (13.), 346 (38.)
beste Teiler: 4.4 (11.), 10.1 (17.), 22.2 (20.)
Trefferlage: 0.04 mm rechts, 0.25 mm hoch
Streuwert: 1.41, horizontal: 1.30, vertikal: 1.51

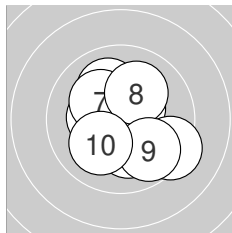
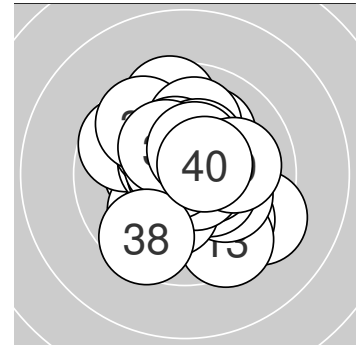

Serie 1: 100.8 (98)

10.5* ↗	10.3* ↓	10.3* ←	10.2* ↓	10.0 ↖
9.3 ↘	10.2* ↘	10.1 ↗	9.8 ↘	10.1 ↗

beste Teiler: 120.1 (1.), 159.6 (3.), 174.3 (2.)
Trefferlage: 0.33 mm rechts, 0.33 mm tief
Streuwert: 1.70, horizontal: 1.67, vertikal: 1.73

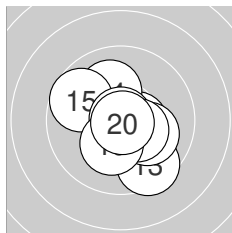

Serie 2: 103.3 (98)

10.9* ↗	10.5* →	9.5 ↓	10.1 ↖	9.7 ↘
10.1 ↘	10.9* ↑	10.4* ↘	10.3* ↓	10.9* ↘

beste Teiler: 4.4 (11.), 10.1 (17.), 22.2 (20.)
Trefferlage: 0.21 mm rechts, 0.32 mm tief
Streuwert: 1.43, horizontal: 1.42, vertikal: 1.44

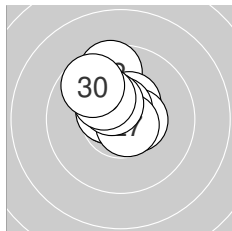

Serie 3: 103.4 (98)

10.6* ↘	9.6 ↑	10.4* ↗	10.5* →	10.7* ↑
10.5* ↘	10.7* ↘	10.5* ↘	10.2* ↘	9.7 ↘

beste Teiler: 62.4 (27.), 74.0 (25.), 91.5 (21.)
Trefferlage: 0.39 mm links, 1.06 mm hoch
Streuwert: 1.03, horizontal: 0.93, vertikal: 1.11

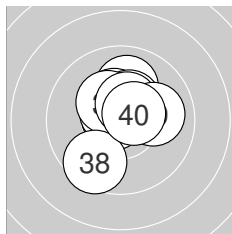

Serie 4: 103.0 (99)

10.7* ←	10.0 ↑	10.6* ↘	10.4* ↖	10.4* ↗
10.3* ↘	10.5* ↑	9.6 ↗	10.0 →	10.5* ↗

beste Teiler: 52.3 (31.), 83.8 (33.), 104.2 (40.)
Trefferlage: 0.03 mm rechts, 0.60 mm hoch
Streuwert: 1.29, horizontal: 1.15, vertikal: 1.41

