

Ergebnis: **413.6** (395)
 Serien: 102.2 103.7 103.5 104.2
 Zähler: 35 5 0 0 0 0 0 0 0 0
 Innenzehner: 29
 Weitest: 333 (18.), 311 (3.), 295 (8.)
 beste Teiler: 44.0 (13.), 61.0 (16.), 67.0 (24.)
 Trefferlage: 0.07 mm rechts, 0.28 mm tief
 Streuwert: 1.19, horizontal: 1.24, vertikal: 1.14

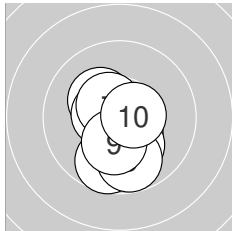
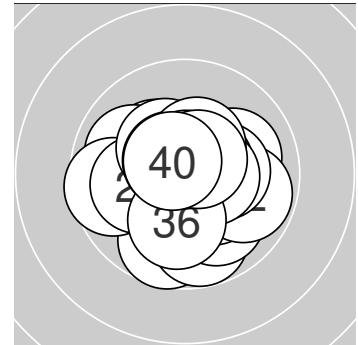

Serie 1: 102.2 (98)

10.1 ↓	10.2* ↖	9.7 ↓	10.5* ←	10.4* ↘
10.1 ↓	10.5* ↖	9.8 ↓	10.3* ↓	10.6* →

beste Teiler: 96.0 (10.), 110.0 (4.), 111.1 (7.)
 Trefferlage: 0.07 mm links, 1.02 mm tief
 Streuwert: 1.24, horizontal: 0.88, vertikal: 1.52

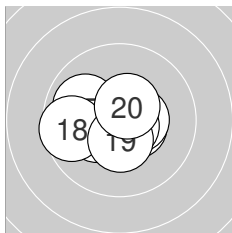

Serie 2: 103.7 (98)

10.3* ←	10.5* ↘	10.8* ↓	10.5* →	10.5* ←
10.7* ↘	9.9 ↖	9.6 ←	10.4* ↓	10.5* ↗

beste Teiler: 44.0 (13.), 61.0 (16.), 109.1 (20.)
 Trefferlage: 0.50 mm links, 0.16 mm tief
 Streuwert: 1.17, horizontal: 1.50, vertikal: 0.71

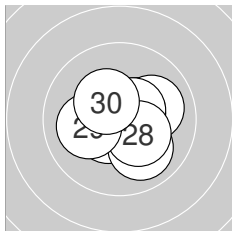

Serie 3: 103.5 (100)

10.5* ↗	10.5* ↗	10.0 →	10.7* ↘	10.0 ↘
10.5* ↗	10.5* ↖	10.3* ↘	10.1 ←	10.4* ↖

beste Teiler: 67.0 (24.), 108.4 (26.), 111.0 (21.)
 Trefferlage: 0.27 mm rechts, 0.07 mm tief
 Streuwert: 1.19, horizontal: 1.36, vertikal: 1.00

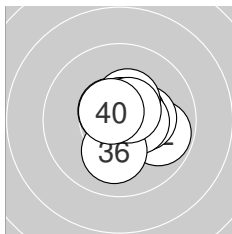

Serie 4: 104.2 (99)

10.6* ↖	9.8 ↘	10.3* →	10.6* ↗	10.5* →
10.1 ↓	10.4* ↗	10.7* ↑	10.6* ↗	10.6* ↖

beste Teiler: 67.2 (38.), 82.7 (40.), 87.6 (31.)
 Trefferlage: 0.60 mm rechts, 0.13 mm hoch
 Streuwert: 1.01, horizontal: 1.05, vertikal: 0.97



LG 40 ZR

StandNr: 102

Obholzer,, Sylvia #70803032

Senioren_2w

Wertung

StartNr: 183

03.03.2024 16:24

SG_Eben

Ergebnis: **0.0** (0)_{DNS}
Serien:
Zähler: 0 0 0 0 0 0 0 0 0 0 0
Innenzehner: 0
Weiteste:
~~beste Teiler~~
Trefferlage: 0.00 mm , 0.00 mm
Streuwert:

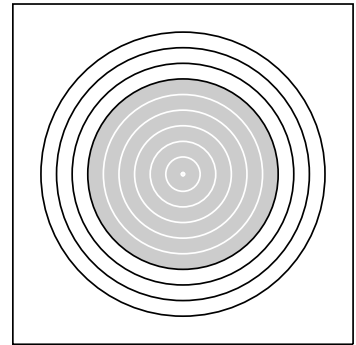

Ergebnis: 414.9 (393)
Serien: 104.5 102.6 105.1 102.7
Zähler: 34 5 1 0 0 0 0 0 0 0
Innenzehner: 29
Weiteste: 571 (14.), 301 (34.), 286 (33.)
beste Teiler: 23.3 (25.), 38.1 (26.), 41.1 (28.)
Trefferlage: 0.45 mm links, 0.82 mm tief
Streuwert: 1.10, horizontal: 1.17, vertikal: 1.03

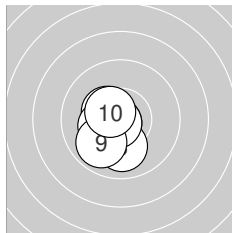
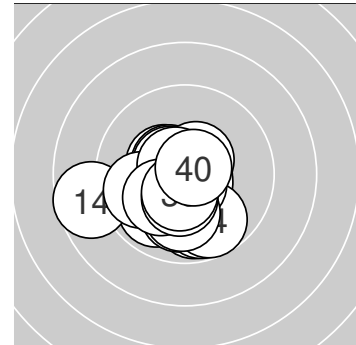

Serie 1: 104.5 (99)

10.4* ↘	10.8* ↙	10.4* ↙	10.7* ↙	10.3* ↙
10.0 ↓	10.7* ↙	10.8* ↙	9.9 ↙	10.5* ↘

beste Teiler: 50.3 (2.), 50.9 (8.), 64.0 (7.)
Trefferlage: 0.81 mm links, 0.57 mm tief
Streuwert: 0.80, horizontal: 0.58, vertikal: 0.98

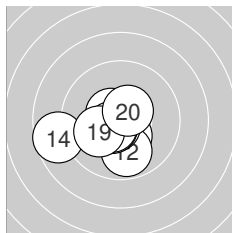

Serie 2: 102.6 (97)

10.4* ↓	9.8 ↓	10.8* ←	8.7 ←	10.7* ↙
10.5* ↘	10.5* ↙	10.6* ↙	10.1 ←	10.5* ↗

beste Teiler: 42.0 (13.), 75.0 (15.), 97.8 (18.)
Trefferlage: 0.90 mm links, 0.70 mm tief
Streuwert: 1.47, horizontal: 1.80, vertikal: 1.04

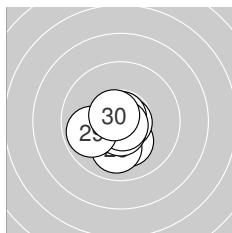

Serie 3: 105.1 (99)

10.2* ↓	10.6* ↙	10.0 ↓	10.7* →	10.9* ↘
10.8* ↑	10.6* ↓	10.8* ↓	9.9 ←	10.6* ↘

beste Teiler: 23.3 (25.), 38.1 (26.), 41.1 (28.)
Trefferlage: 0.31 mm links, 0.56 mm tief
Streuwert: 0.92, horizontal: 0.91, vertikal: 0.92

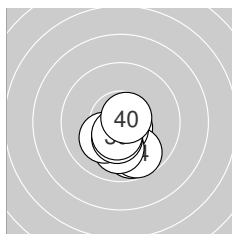

Serie 4: 102.7 (98)

10.0 ↓	10.7* ↘	9.8 ↓	9.7 ↓	10.7* ↓
10.0 ↓	10.2* ↙	10.4* ↓	10.5* ↓	10.7* ↗

beste Teiler: 62.8 (40.), 64.5 (35.), 75.1 (32.)
Trefferlage: 0.20 mm rechts, 1.45 mm tief
Streuwert: 0.92, horizontal: 0.79, vertikal: 1.04



Ergebnis: **414.1** (396)
 Serien: 102.8 104.7 102.7 103.9
 Zähler: 36 4 0 0 0 0 0 0 0 0
 Innenzehner: 28
 Weitest: 337 (29.), 294 (25.), 272 (1.)
 beste Teiler: 13.0 (30.), 18.2 (27.), 22.8 (12.)
 Trefferlage: 0.79 mm links, 0.04 mm tief
 Streuwert: 1.07, horizontal: 1.13, vertikal: 1.00

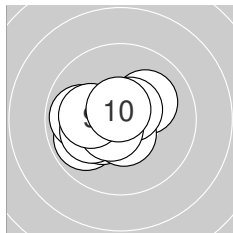
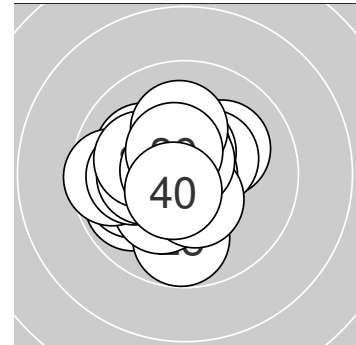

Serie 1: 102.8 (98)

9.9 ↙	10.3* ↙	10.1 ↗	10.5* ↓	9.9 ←
10.1 ←	10.6* ↗	10.6* ↘	10.1 ←	10.7* ↑

beste Teiler: 69.6 (10.), 94.0 (7.), 94.0 (8.)
 Trefferlage: 0.86 mm links, 0.17 mm tief
 Streuwert: 1.20, horizontal: 1.46, vertikal: 0.86

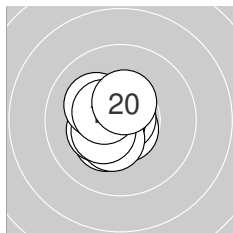

Serie 2: 104.7 (100)

10.7* ↓	10.9* ↗	10.3* ↘	10.3* ←	10.7* ←
10.4* ↓	10.4* ↙	10.2* ↖	10.4* ↖	10.4* ↑

beste Teiler: 22.8 (12.), 57.9 (15.), 73.5 (11.)
 Trefferlage: 0.68 mm links, 0.18 mm tief
 Streuwert: 0.84, horizontal: 0.75, vertikal: 0.91

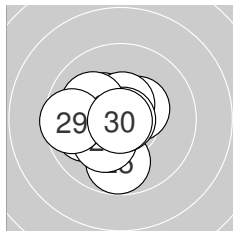

Serie 3: 102.7 (98)

10.3* ↖	10.0 ←	10.4* ↗	10.5* ↑	9.8 ↓
10.2* ↙	10.9* →	10.1 ↖	9.6 ←	10.9* ↓

beste Teiler: 13.0 (30.), 18.2 (27.), 103.6 (24.)
 Trefferlage: 0.87 mm links, 0.16 mm tief
 Streuwert: 1.33, horizontal: 1.38, vertikal: 1.27

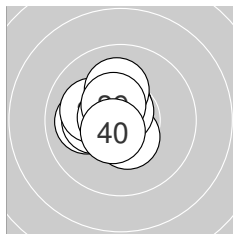

Serie 4: 103.9 (100)

10.5* ↓	10.0 ←	10.2* ←	10.6* ↑	10.1 ↖
10.7* ↑	10.6* ↖	10.1 ↑	10.5* ↖	10.6* ↙

beste Teiler: 62.2 (36.), 78.1 (37.), 94.0 (40.)
 Trefferlage: 0.77 mm links, 0.35 mm hoch
 Streuwert: 0.95, horizontal: 0.95, vertikal: 0.95



Ergebnis: **410.8** (392)
 Serien: 102.9 103.0 101.3 103.6
 Zähler: 33 6 1 0 0 0 0 0 0 0
 Innenzehner: 27
 Weitester: 639 (27.), 287 (19.), 282 (16.)
 beste Teiler: 27.1 (7.), 37.3 (23.), 40.6 (5.)
 Trefferlage: 0.25 mm links, 0.20 mm tief
 Streuwert: 1.40, horizontal: 1.60, vertikal: 1.18

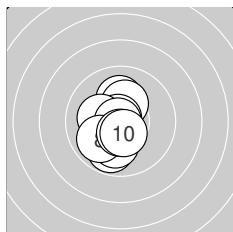
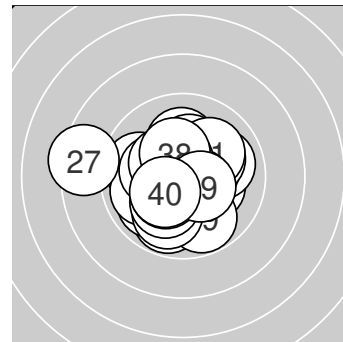

Serie 1: 102.9 (98)

10.1 ↑	9.8 ↓	10.0 ↓	10.3* ↑	10.8* ↖
10.2* ←	10.8* ←	9.9 ↗	10.5* ↓	10.5* ↓

beste Teiler: 27.1 (7.), 40.6 (5.), 110.1 (9.)
 Trefferlage: 0.53 mm links, 0.43 mm tief
 Streuwert: 1.27, horizontal: 0.83, vertikal: 1.59

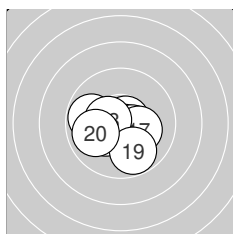

Serie 2: 103.0 (97)

10.6* ↘	10.7* ↗	10.3* ↖	10.7* ↘	10.5* ↘
9.8 ←	10.2* ↘	10.5* ←	9.8 ↓	9.9 ↖

beste Teiler: 58.8 (12.), 59.5 (14.), 95.1 (11.)
 Trefferlage: 0.21 mm links, 0.53 mm tief
 Streuwert: 1.29, horizontal: 1.59, vertikal: 0.90

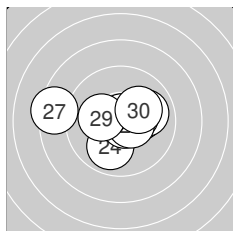

Serie 3: 101.3 (97)

10.2* →	10.0 →	10.8* ↑	9.9 ↓	10.4* →
10.8* ↘	8.4 ←	10.5* →	10.2* ←	10.1 ↗

beste Teiler: 37.3 (23.), 50.3 (26.), 102.7 (28.)
 Trefferlage: 0.03 mm links, 0.14 mm hoch
 Streuwert: 1.94, horizontal: 2.56, vertikal: 1.00

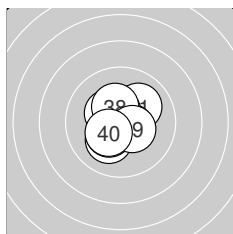

Serie 4: 103.6 (100)

10.1 ↗	10.7* ↖	10.1 ↓	10.5* ↘	10.5* ↑
10.4* ↖	10.3* ↗	10.3* ↑	10.4* ↘	10.3* ↖

beste Teiler: 65.1 (32.), 104.0 (35.), 106.9 (34.)
 Trefferlage: 0.22 mm links, 0.01 mm hoch
 Streuwert: 1.11, horizontal: 1.07, vertikal: 1.15



Ergebnis: 413.3 (394)
Serien: 103.7 102.8 104.3 102.5
Zähler: 34 6 0 0 0 0 0 0 0 0 0
Innenzehner: 29
Weiteste: 476 (38.), 338 (40.), 289 (16.)
beste Teiler: 12.6 (28.), 26.4 (7.), 38.8 (37.)
Trefferlage: 0.22 mm links, 0.50 mm tief
Streuwert: 1.23, horizontal: 1.39, vertikal: 1.05

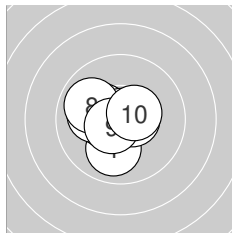
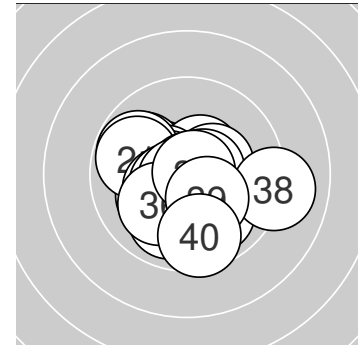

Serie 1: 103.7 (99)

10.0 ↓	10.5* ↖	10.3* ↖	10.4* ←	10.6* →
10.1 ←	10.8* ↑	9.9 ↖	10.6* ↗	10.5* ↗

beste Teiler: 26.4 (7.), 88.4 (9.), 95.0 (5.)
Trefferlage: 0.75 mm links, 0.03 mm hoch
Streuwert: 1.07, horizontal: 1.17, vertikal: 0.95

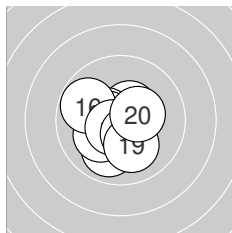

Serie 2: 102.8 (98)

10.5* ↗	10.4* ↖	9.9 ↓	10.5* ←	10.2* ↗
9.8 ↖	10.6* ↗	10.4* ↘	10.1 ↓	10.4* ↗

beste Teiler: 87.0 (17.), 105.5 (14.), 119.2 (11.)
Trefferlage: 0.45 mm links, 0.40 mm tief
Streuwert: 1.25, horizontal: 1.29, vertikal: 1.22

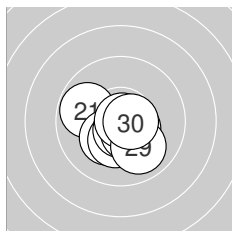

Serie 3: 104.3 (99)

9.8 ↖	10.7* ↓	10.3* ↗	10.5* ↘	10.3* ↓
10.7* ↓	10.5* ↘	10.9* →	10.0 ↘	10.6* →

beste Teiler: 12.6 (28.), 51.4 (22.), 72.0 (26.)
Trefferlage: 0.00 mm , 0.67 mm tief
Streuwert: 1.03, horizontal: 1.19, vertikal: 0.85

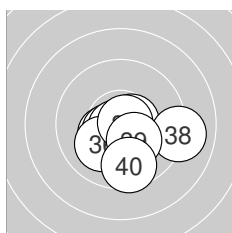

Serie 4: 102.5 (98)

10.4* ↗	10.5* ↗	10.6* →	10.4* ↓	10.8* ↗
10.1 ↗	10.8* →	9.0 →	10.3* ↘	9.6 ↓

beste Teiler: 38.8 (37.), 50.8 (35.), 90.0 (33.)
Trefferlage: 0.32 mm rechts, 0.97 mm tief
Streuwert: 1.45, horizontal: 1.78, vertikal: 1.02



Ergebnis: **417.8** (398)
 Serien: 102.8 105.1 106.0 103.9
 Zähler: 38 2 0 0 0 0 0 0 0 0
 Innenzehner: 34
 Weitester: 407 (4.), 317 (36.), 245 (10.)
 beste Teiler: 18.3 (2.), 23.2 (19.), 27.6 (33.)
 Trefferlage: 0.18 mm rechts, 0.08 mm hoch
 Streuwert: 1.06, horizontal: 0.99, vertikal: 1.13

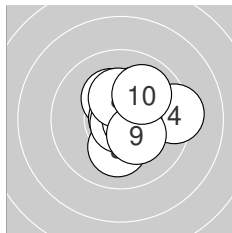
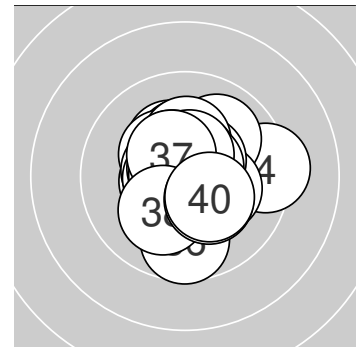

Serie 1: 102.8 (99)

10.3* ↖	10.9* ↖	10.1 ↓	9.3 →	10.8* ↓
10.6* →	10.2* ↗	10.3* ↑	10.3* ↘	10.0 ↗

beste Teiler: 18.3 (2.), 29.6 (5.), 86.4 (6.)
 Trefferlage: 0.73 mm rechts, 0.35 mm hoch
 Streuwert: 1.36, horizontal: 1.39, vertikal: 1.33

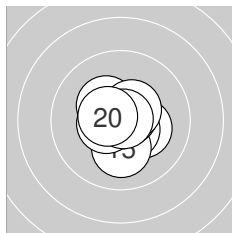

Serie 2: 105.1 (100)

10.3* ↖	10.7* →	10.3* →	10.6* ↘	10.1 ↓
10.5* ←	10.7* ↗	10.5* ↗	10.9* →	10.5* ↖

beste Teiler: 23.2 (19.), 63.2 (17.), 74.6 (12.)
 Trefferlage: 0.15 mm rechts, 0.12 mm tief
 Streuwert: 0.91, horizontal: 0.93, vertikal: 0.89

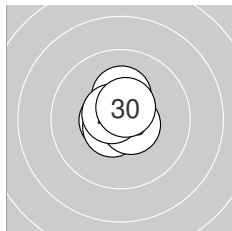

Serie 3: 106.0 (100)

10.6* ↑	10.8* ↑	10.7* ↖	10.7* ↖	10.2* ↑
10.6* ←	10.6* ↗	10.6* ↘	10.6* ↖	10.6* ↗

beste Teiler: 49.0 (22.), 63.1 (23.), 73.8 (24.)
 Trefferlage: 0.19 mm links, 0.42 mm hoch
 Streuwert: 0.62, horizontal: 0.52, vertikal: 0.70

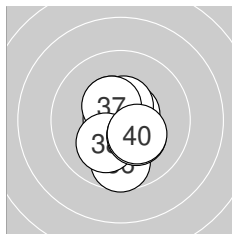

Serie 4: 103.9 (99)

10.5* ↖	10.7* ←	10.8* →	10.6* ↗	10.5* ↑
9.7 ↓	10.4* ↖	10.1 ↗	10.3* ↘	10.3* ↘

beste Teiler: 27.6 (33.), 58.3 (32.), 85.1 (34.)
 Trefferlage: 0.06 mm rechts, 0.34 mm tief
 Streuwert: 1.15, horizontal: 0.82, vertikal: 1.41



Ergebnis: **409.0** (391)
Serien: 101.5 102.9 102.5 102.1
Zähler: 31 9 0 0 0 0 0 0 0 0
Innenzehner: 25
Weiteste: 340 (5.), 335 (1.), 307 (34.)
beste Teiler: 68.8 (40.), 71.8 (35.), 72.1 (3.)
Trefferlage: 0.13 mm rechts, 0.08 mm tief
Streuwert: 1.42, horizontal: 1.56, vertikal: 1.26

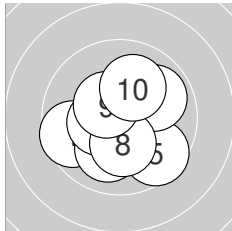
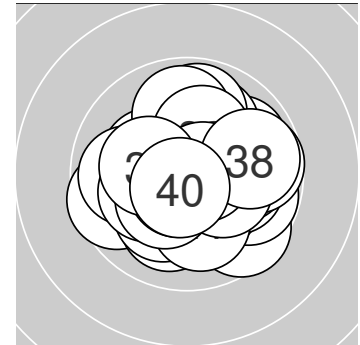

Serie 1: 101.5 (97)

9.6 ←	10.0 ↓	10.7* ↗	10.5* ↓	9.6 ↘
9.9 ↗	10.4* ←	10.2* ↓	10.5* ↖	10.1 ↑

beste Teiler: 72.1 (3.), 108.7 (4.), 121.6 (9.)
Trefferlage: 0.08 mm rechts, 0.41 mm tief
Streuwert: 1.60, horizontal: 1.70, vertikal: 1.50

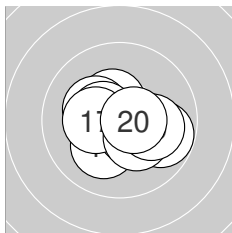

Serie 2: 102.9 (99)

10.2* ↓	10.4* ↖	9.8 →	10.2* ↖	10.5* ↖
10.5* ↘	10.3* ←	10.3* ↘	10.1 →	10.6* →

beste Teiler: 95.0 (20.), 112.4 (16.), 117.9 (15.)
Trefferlage: 0.18 mm rechts, 0.27 mm tief
Streuwert: 1.29, horizontal: 1.58, vertikal: 0.91

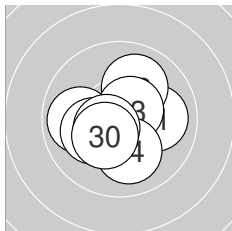

Serie 3: 102.5 (99)

10.0 →	10.0 ↑	10.6* ↗	10.1 ↓	10.4* ←
10.4* ↖	9.9 ←	10.2* ←	10.5* ↖	10.4* ↖

beste Teiler: 96.3 (23.), 105.3 (29.), 140.1 (26.)
Trefferlage: 0.39 mm links, 0.34 mm tief
Streuwert: 1.35, horizontal: 1.52, vertikal: 1.15

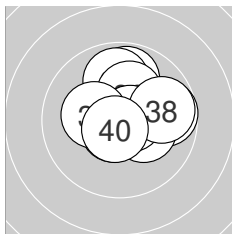

Serie 4: 102.1 (96)

9.8 ↑	9.9 ↑	10.2* ↑	9.7 →	10.7* ↓
10.3* ↘	10.7* →	9.8 →	10.3* ←	10.7* ↓

beste Teiler: 68.8 (40.), 71.8 (35.), 72.6 (37.)
Trefferlage: 0.66 mm rechts, 0.69 mm hoch
Streuwert: 1.38, horizontal: 1.49, vertikal: 1.27



Ergebnis: 415.8 (396)
Serien: 103.4 104.1 105.3 103.0
Zähler: 36 4 0 0 0 0 0 0 0 0 0
Innenzehner: 33
Weiteste: 368 (34.), 335 (2.), 280 (32.)
beste Teiler: 14.7 (4.), 34.3 (36.), 37.8 (21.)
Trefferlage: 0.32 mm rechts, 0.14 mm tief
Streuwert: 1.12, horizontal: 1.07, vertikal: 1.16

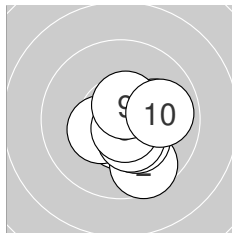
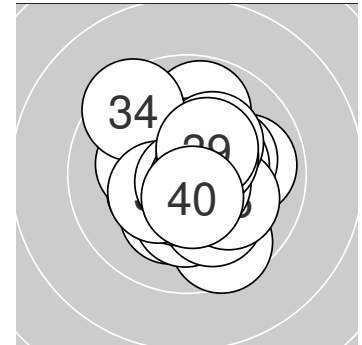

Serie 1: 103.4 (98)

10.5* ↓	9.6 ↓	10.3* ↘	10.9* ↗	10.4* ↙
10.1 →	10.4* ↘	10.7* ↘	10.6* ↗	9.9 →

beste Teiler: 14.7 (4.), 66.6 (8.), 98.6 (9.)
Trefferlage: 0.73 mm rechts, 0.60 mm tief
Streuwert: 1.15, horizontal: 1.15, vertikal: 1.14

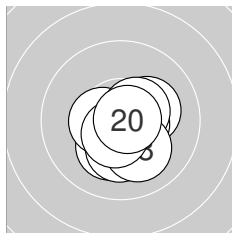

Serie 2: 104.1 (100)

10.2* →	10.2* ↓	10.5* ↘	10.5* ←	10.5* →
10.5* ↗	10.2* ↓	10.1 ↓	10.6* ↓	10.8* →

beste Teiler: 45.2 (20.), 96.9 (19.), 102.3 (15.)
Trefferlage: 0.36 mm rechts, 0.63 mm tief
Streuwert: 0.94, horizontal: 0.92, vertikal: 0.96

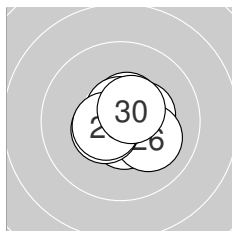

Serie 3: 105.3 (100)

10.8* ←	10.6* ↓	10.6* →	10.5* ↗	10.4* →
10.1 ↘	10.5* ↙	10.7* ↑	10.6* ←	10.5* ↗

beste Teiler: 37.8 (21.), 69.3 (28.), 82.2 (23.)
Trefferlage: 0.29 mm rechts, 0.02 mm tief
Streuwert: 0.83, horizontal: 0.94, vertikal: 0.72

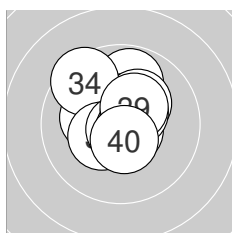

Serie 4: 103.0 (98)

10.2* ←	9.8 ↑	10.2* ↗	9.5 ↓	10.4* ↙
10.8* ↓	10.7* ↘	10.5* ↗	10.4* ↗	10.5* ↓

beste Teiler: 34.3 (36.), 70.2 (37.), 104.7 (40.)
Trefferlage: 0.11 mm links, 0.67 mm hoch
Streuwert: 1.30, horizontal: 1.24, vertikal: 1.37



Ergebnis: **412.2** (394)
 Serien: 102.4 103.5 102.0 104.3
 Zähler: 34 6 0 0 0 0 0 0 0 0
 Innenzehner: 27
 Weitester: 406 (6.), 339 (7.), 294 (20.)
 beste Teiler: 25.0 (37.), 40.2 (19.), 41.0 (36.)
 Trefferlage: 0.68 mm links, 0.03 mm hoch
 Streuwert: 1.25, horizontal: 1.15, vertikal: 1.34

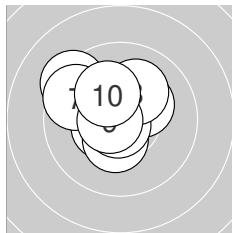
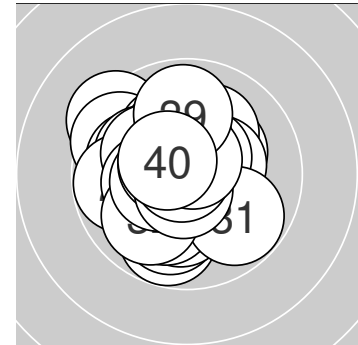

Serie 1: 102.4 (98)

10.5* ↙	10.4* ↓	10.5* ↘	10.3* ↗	10.8* ↓
9.3 ↘	9.6 ↘	10.1 ↗	10.7* ←	10.2* ↖

beste Teiler: 43.8 (5.), 73.4 (9.), 119.5 (3.)
 Trefferlage: 0.79 mm links, 0.70 mm hoch
 Streuwert: 1.37, horizontal: 1.49, vertikal: 1.24

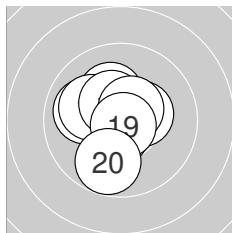

Serie 2: 103.5 (99)

10.6* ↓	10.2* ↖	10.0 ↖	10.7* ↓	10.4* →
10.1 ↖	10.4* ↖	10.5* ↗	10.8* ↘	9.8 ↓

beste Teiler: 40.2 (19.), 63.0 (14.), 96.7 (11.)
 Trefferlage: 0.49 mm links, 0.09 mm hoch
 Streuwert: 1.21, horizontal: 1.12, vertikal: 1.30

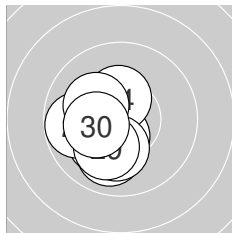

Serie 3: 102.0 (99)

10.0 ↓	10.4* ↖	10.5* ↓	10.4* ↑	10.1 ↖
10.2* ↓	9.8 ←	10.2* ↖	10.1 ↓	10.3* ←

beste Teiler: 120.6 (23.), 140.0 (22.), 142.6 (24.)
 Trefferlage: 1.13 mm links, 0.66 mm tief
 Streuwert: 1.11, horizontal: 0.85, vertikal: 1.31

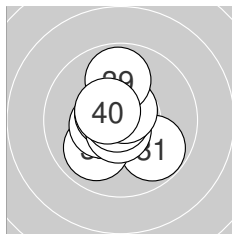

Serie 4: 104.3 (98)

9.8 ↘	10.0 ↖	10.4* ←	10.6* ↖	10.7* ↓
10.8* ↖	10.9* ←	10.7* ↗	9.9 ↑	10.5* ↖

beste Teiler: 25.0 (37.), 41.0 (36.), 69.8 (35.)
 Trefferlage: 0.31 mm links, 0.00 mm
 Streuwert: 1.21, horizontal: 1.05, vertikal: 1.35

