

Ergebnis: **385.9** (367)
 Serien: 97.8 94.1 95.6 98.4
 Zähler: 13 21 6 0 0 0 0 0 0 0
 Innenzehner: 11
 Weitestе: 617 (11.), 615 (27.), 594 (20.)
 beste Teiler: 79.6 (35.), 97.1 (26.), 106.3 (3.)
 Trefferlage: 0.85 mm rechts, 0.56 mm hoch
 Streuwert: 2.48, horizontal: 2.79, vertikal: 2.12

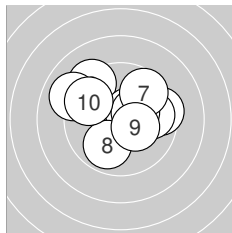
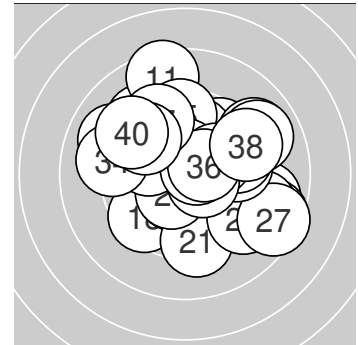

Serie 1: 97.8 (93)

9.5 →	9.3 ↘	10.5* ↗	9.8 →	10.3* ↗
9.0 ↖	9.6 ↗	9.9 ↘	10.3* ↘	9.6 ↖

beste Teiler: 106.3 (3.), 151.2 (5.), 154.3 (9.)
 Trefferlage: 0.09 mm rechts, 0.89 mm hoch
 Streuwert: 2.24, horizontal: 2.72, vertikal: 1.63

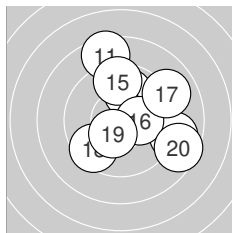

Serie 2: 94.1 (89)

8.5 ↑	9.5 →	9.9 ↑	8.9 →	9.5 ↑
10.3* →	9.0 ↗	9.5 ↘	10.4* ↘	8.6 ↘

beste Teiler: 144.2 (19.), 175.0 (16.), 261.5 (13.)
 Trefferlage: 1.53 mm rechts, 0.81 mm hoch
 Streuwert: 2.84, horizontal: 2.80, vertikal: 2.87

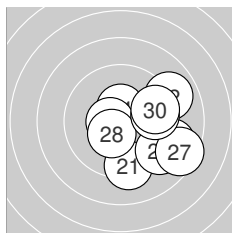

Serie 3: 95.6 (90)

9.3 ↓	8.9 →	8.9 →	10.5* ↑	9.2 ↘
10.6* ←	8.5 ↘	10.4* ↘	9.7 →	9.6 →

beste Teiler: 97.1 (26.), 119.0 (24.), 141.2 (28.)
 Trefferlage: 2.35 mm rechts, 0.77 mm tief
 Streuwert: 2.26, horizontal: 2.40, vertikal: 2.10

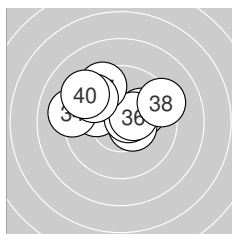

Serie 4: 98.4 (95)

10.1 ↗	10.5* ↘	10.0 ↖	9.1 ←	10.6* ↗
10.4* ↗	9.5 ↖	9.3 ↗	9.6 ↖	9.3 ↖

beste Teiler: 79.6 (35.), 119.4 (32.), 129.7 (36.)
 Trefferlage: 0.54 mm links, 1.30 mm hoch
 Streuwert: 2.04, horizontal: 2.65, vertikal: 1.15



Ergebnis: **390.0** (369)
 Serien: 98.2 93.7 97.8 100.3
 Zähler: 17 18 4 0 0 1 0 0 0 0 0
 Innenzehner: 14
 Weitester: 1304 (19.), 550 (11.), 536 (6.)
 beste Teiler: 9.0 (18.), 61.8 (28.), 112.6 (31.)
 Trefferlage: 0.07 mm rechts, 0.58 mm hoch
 Streuwert: 2.57, horizontal: 2.99, vertikal: 2.08

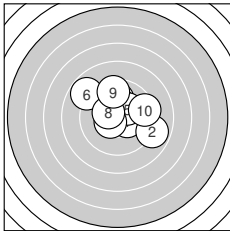
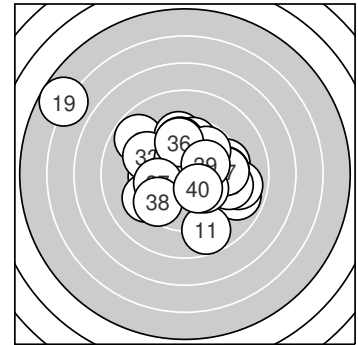

Serie 1: 98.2 (93)

10.4* ↘ 8.9 ↘ 9.9 ↑ 10.2* ↑ 10.2* ↗
 8.8 ↘ 10.5* ↗ 10.4* ↘ 9.5 ↑ 9.4 ↗
 beste Teiler: 120.6 (7.), 143.1 (8.), 145.0 (1.)
 Trefferlage: 0.41 mm rechts, 1.07 mm hoch
 Streuwert: 2.22, horizontal: 2.58, vertikal: 1.79

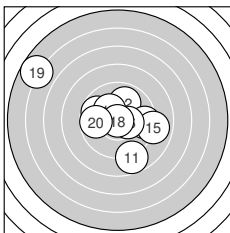

Serie 2: 93.7 (87)

8.8 ↓ 9.9 ↑ 9.4 → 9.7 ↘ 8.9 →
 10.4* → 10.2* ↘ 10.9* ↓ 5.7 ↘ 9.8 ←
 beste Teiler: 9.0 (18.), 144.5 (16.), 179.2 (17.)
 Trefferlage: 0.51 mm links, 0.44 mm hoch
 Streuwert: 3.84, horizontal: 4.55, vertikal: 2.97

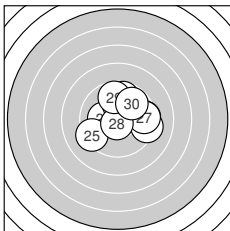

Serie 3: 97.8 (93)

10.2* ← 9.5 → 9.3 → 10.1 ↑ 9.3 ↗
 9.7 ↑ 9.5 → 10.7* ↓ 9.7 ↑ 9.8 ↗
 beste Teiler: 61.8 (28.), 192.4 (21.), 201.4 (24.)
 Trefferlage: 0.82 mm rechts, 0.70 mm hoch
 Streuwert: 2.18, horizontal: 2.53, vertikal: 1.77

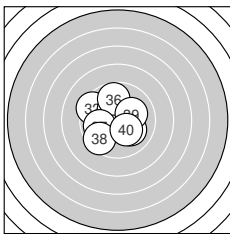

Serie 4: 100.3 (96)

10.5* ↓ 9.4 ↘ 10.5* ↑ 10.3* ↘ 10.1 ↘
 9.8 ↑ 9.9 ← 9.5 ↗ 10.1 ↗ 10.2* ↘
 beste Teiler: 112.6 (31.), 120.0 (33.), 160.4 (34.)
 Trefferlage: 0.44 mm links, 0.12 mm hoch
 Streuwert: 1.81, horizontal: 1.88, vertikal: 1.74



Ergebnis: **400.3** (380)
 Serien: 95.9 100.9 102.7 100.8
 Zähler: 23 15 1 1 0 0 0 0 0 0
 Innenzehner: 19
 Weitester: 803 (7.), 527 (18.), 492 (8.)
 beste Teiler: 42.4 (21.), 44.4 (29.), 52.4 (12.)
 Trefferlage: 1.04 mm links, 0.00 mm
 Streuwert: 1.89, horizontal: 2.13, vertikal: 1.60

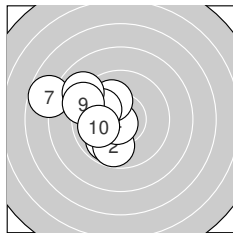
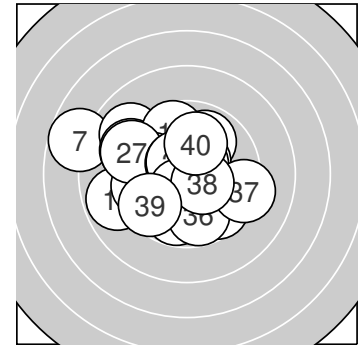

Serie 1: 95.9 (92)

9.9 ↙	9.8 ↓	9.5 ↘	10.7* ↙	10.1 ↖
10.0 ↖	7.7 ↖	9.0 ↖	9.2 ↖	10.0 ←

beste Teiler: 58.8 (4.), 219.6 (5.), 236.5 (6.)
 Trefferlage: 2.68 mm links, 0.56 mm hoch
 Streuwert: 2.09, horizontal: 2.17, vertikal: 2.01

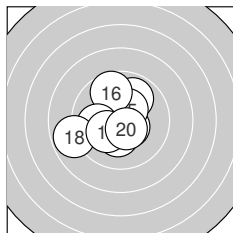

Serie 2: 100.9 (95)

9.9 ↗	10.7* ↓	10.3* ↓	10.5* ↘	10.4* ↗
9.7 ↖	9.9 ←	8.8 ←	10.2* ↙	10.5* ↘

beste Teiler: 52.4 (12.), 110.3 (20.), 113.2 (14.)
 Trefferlage: 0.68 mm links, 0.08 mm tief
 Streuwert: 1.79, horizontal: 1.91, vertikal: 1.66

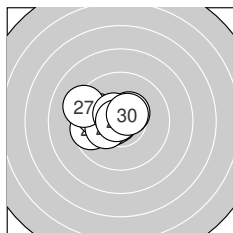

Serie 3: 102.7 (97)

10.8* ←	10.6* ←	9.6 ←	9.9 ↖	10.3* ←
10.4* ↗	9.3 ↖	10.5* ↘	10.8* ↖	10.5* ↗

beste Teiler: 42.4 (21.), 44.4 (29.), 96.5 (22.)
 Trefferlage: 1.21 mm links, 0.29 mm hoch
 Streuwert: 1.26, horizontal: 1.60, vertikal: 0.78

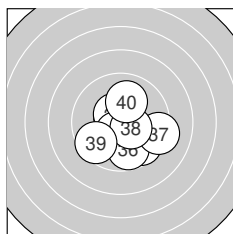

Serie 4: 100.8 (96)

10.6* ↘	9.7 ↘	10.5* ↘	10.4* ↓	10.5* ↓
9.8 ↓	9.3 →	10.4* ↘	9.6 ↙	10.0 ↑

beste Teiler: 81.8 (31.), 109.0 (33.), 122.7 (35.)
 Trefferlage: 0.39 mm rechts, 0.81 mm tief
 Streuwert: 1.72, horizontal: 1.84, vertikal: 1.59



Ergebnis: **388.2** (374)
 Serien: 98.4 96.9 100.3 92.6
 Zähler: 21 13 5 1 0 0 0 0 0 0
 Innenzehner: 12
 Weitester: 861 (31.), 721 (38.), 610 (39.)
 beste Teiler: 31.2 (23.), 73.4 (29.), 75.6 (16.)
 Trefferlage: 0.35 mm rechts, 0.04 mm tief
 Streuwert: 2.62, horizontal: 3.06, vertikal: 2.08

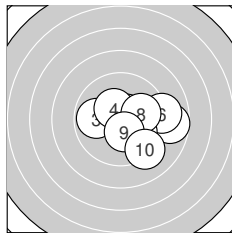
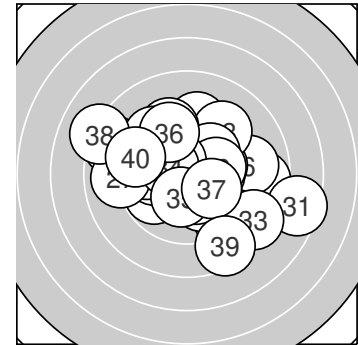

Serie 1: 98.4 (95)

8.7 → 10.6* ↗ 9.9 ← 10.4* ↖ 10.1 →
 9.1 → 10.0 ↘ 10.0 → 10.4* ↓ 9.2 ↘
 beste Teiler: 84.8 (2.), 142.3 (4.), 147.8 (9.)
 Trefferlage: 1.66 mm rechts, 0.43 mm tief
 Streuwert: 1.98, horizontal: 2.44, vertikal: 1.38

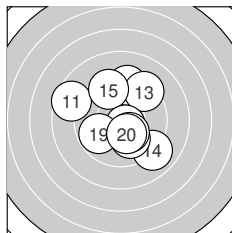

Serie 2: 96.9 (93)

8.6 ↖ 9.4 ↑ 9.3 ↗ 9.0 ↘ 9.5 ↖
 10.7* ↘ 10.0 ↘ 10.3* ↘ 9.8 ↖ 10.3* ↘
 beste Teiler: 75.6 (16.), 166.5 (20.), 169.2 (18.)
 Trefferlage: 0.08 mm rechts, 0.24 mm hoch
 Streuwert: 2.65, horizontal: 2.62, vertikal: 2.68

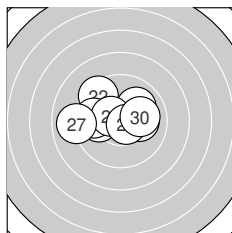

Serie 3: 100.3 (97)

10.0 ← 9.4 ↖ 10.8* → 9.7 ← 10.0 ↗
 10.5* ↖ 9.0 ← 10.1 → 10.7* ↘ 10.1 →
 beste Teiler: 31.2 (23.), 73.4 (29.), 122.0 (26.)
 Trefferlage: 0.70 mm links, 0.51 mm hoch
 Streuwert: 1.88, horizontal: 2.47, vertikal: 0.99

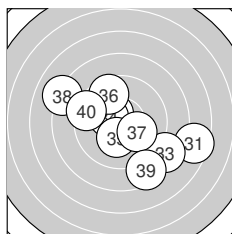

Serie 4: 92.6 (89)

7.5 → 10.4* ↖ 8.5 ↘ 10.4* ↖ 10.2* ↓
 9.6 ↖ 10.1 ↘ 8.1 ↖ 8.5 ↘ 9.3 ↖
 beste Teiler: 126.5 (32.), 146.5 (34.), 178.0 (35.)
 Trefferlage: 0.36 mm rechts, 0.50 mm tief
 Streuwert: 3.62, horizontal: 4.30, vertikal: 2.79



Ergebnis: 398.4 (381)
Serien: 100.3 98.6 98.1 101.4
Zähler: 21 19 0 0 0 0 0 0 0 0 0
Innenzehner: 17
Weiteste: 499 (16.), 487 (29.), 483 (25.)
beste Teiler: 10.2 (9.), 57.8 (40.), 62.2 (1.)
Trefferlage: 0.66 mm links, 0.63 mm hoch
Streuwert: 1.91, horizontal: 2.24, vertikal: 1.51

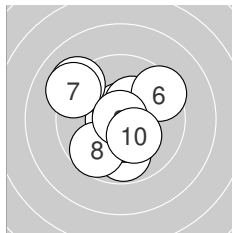
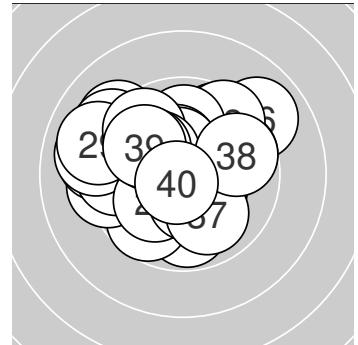

Serie 1: 100.3 (95)

10.7* ←	9.8 ↓	10.7* ↑	10.3* ↗	9.2 ↘
9.5 ↗	9.2 ↘	9.7 ↘	10.9* ↘	10.3* ↘

beste Teiler: 10.2 (9.), 62.2 (1.), 72.0 (3.)
Trefferlage: 0.45 mm links, 0.27 mm hoch
Streuwert: 2.05, horizontal: 2.12, vertikal: 1.97

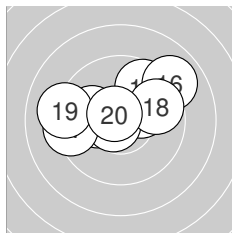

Serie 2: 98.6 (95)

10.2* ↗	10.2* ←	10.0 ←	10.7* ←	9.7 ↗
9.0 ↗	9.3 ←	9.7 →	9.1 ←	10.7* ↘

beste Teiler: 67.1 (14.), 72.1 (20.), 183.8 (11.)
Trefferlage: 0.35 mm links, 0.84 mm hoch
Streuwert: 2.21, horizontal: 2.89, vertikal: 1.19

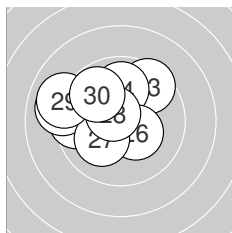

Serie 3: 98.1 (94)

10.4* ↗	9.5 ←	9.5 ↗	9.9 ↑	9.0 ←
10.3* ↘	10.1 ↗	10.6* ↘	9.0 ←	9.8 ↘

beste Teiler: 87.6 (28.), 138.9 (21.), 153.0 (26.)
Trefferlage: 1.46 mm links, 0.79 mm hoch
Streuwert: 1.96, horizontal: 2.32, vertikal: 1.52

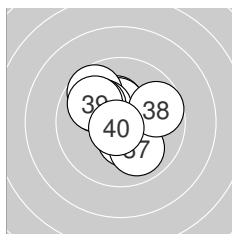

Serie 4: 101.4 (97)

10.3* ↑	10.4* ↓	10.4* ↑	9.7 ↘	10.2* ↘
10.1 ↘	10.0 ↓	9.7 →	9.9 ↘	10.7* ↗

beste Teiler: 57.8 (40.), 139.4 (33.), 142.6 (32.)
Trefferlage: 0.37 mm links, 0.64 mm hoch
Streuwert: 1.52, horizontal: 1.59, vertikal: 1.45



Ergebnis: **399.6** (386)
 Serien: 102.0 99.6 97.6 100.4
 Zähler: 29 8 3 0 0 0 0 0 0 0
 Innenzehner: 17
 Weitester: 563 (21.), 561 (24.), 522 (26.)
 beste Teiler: 43.0 (8.), 44.9 (25.), 82.0 (6.)
 Trefferlage: 0.11 mm links, 0.89 mm hoch
 Streuwert: 1.88, horizontal: 2.27, vertikal: 1.38

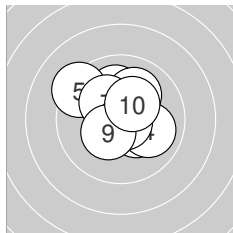
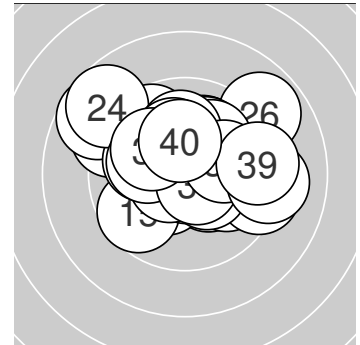

Serie 1: 102.0 (99)

10.1 ↑	10.0 ↗	10.3* ↘	10.0 →	9.3 ↘
10.6* ↙	10.2* ↘	10.8* ↘	10.4* ↙	10.3* ↗

beste Teiler: 43.0 (8.), 82.0 (6.), 145.7 (9.)
 Trefferlage: 0.05 mm links, 0.54 mm hoch
 Streuwert: 1.51, horizontal: 1.60, vertikal: 1.42

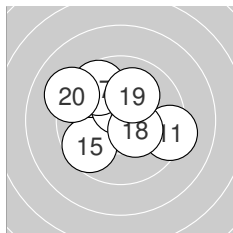

Serie 2: 99.6 (96)

9.3 →	10.0 ↘	10.5* ↘	10.2* ←	9.7 ↙
10.5* ↑	9.7 ↘	10.4* ↘	10.1 ↗	9.2 ↘

beste Teiler: 110.3 (16.), 120.1 (13.), 142.5 (18.)
 Trefferlage: 0.65 mm links, 0.57 mm hoch
 Streuwert: 1.95, horizontal: 2.27, vertikal: 1.57

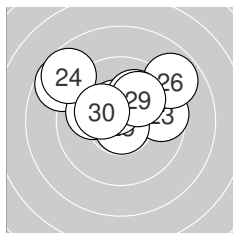

Serie 3: 97.6 (93)

8.7 ↘	10.0 ↖	9.6 →	8.7 ↘	10.8* ↓
8.9 ↗	10.5* ↑	10.1 ↗	10.0 ↗	10.3* ↘

beste Teiler: 44.9 (25.), 120.3 (27.), 171.3 (30.)
 Trefferlage: 0.31 mm links, 1.65 mm hoch
 Streuwert: 2.28, horizontal: 2.94, vertikal: 1.34

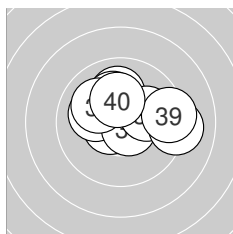

Serie 4: 100.4 (98)

10.0 ↑	10.2* ↑	10.6* ←	10.1 ↖	10.6* ↘
10.1 ↘	10.1 →	9.1 →	9.4 →	10.2* ↑

beste Teiler: 83.6 (35.), 92.1 (33.), 183.0 (40.)
 Trefferlage: 0.54 mm rechts, 0.80 mm hoch
 Streuwert: 1.77, horizontal: 2.28, vertikal: 1.03



Ergebnis: 390.3 (371)
Serien: 95.9 95.8 99.8 98.8
Zähler: 16 19 5 0 0 0 0 0 0 0
Innenzehner: 14
Weiteste: 699 (18.), 642 (34.), 618 (2.)
beste Teiler: 64.1 (39.), 73.6 (17.), 75.7 (13.)
Trefferlage: 0.78 mm links, 0.88 mm hoch
Streuwert: 2.29, horizontal: 2.70, vertikal: 1.80

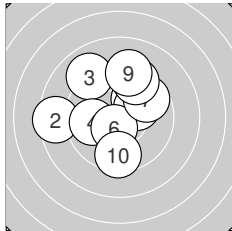
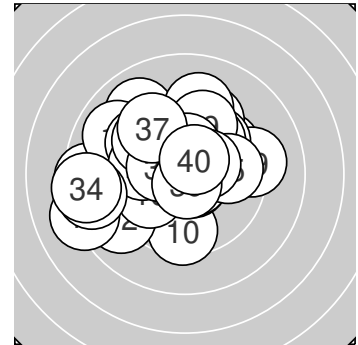

Serie 1: 95.9 (92)

10.0 ↗	8.5 ←	9.0 ↘	9.9 ←	10.2* ↗
10.5* ↘	9.7 ↗	9.4 ↗	9.2 ↑	9.5 ↓

beste Teiler: 115.3 (6.), 191.7 (5.), 226.1 (1.)
Trefferlage: 0.42 mm links, 1.08 mm hoch
Streuwert: 2.61, horizontal: 2.73, vertikal: 2.49

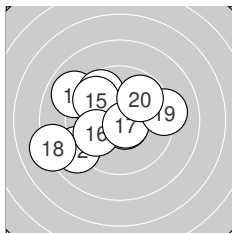

Serie 2: 95.8 (90)

8.9 ↘	9.0 ↙	10.7* ↘	9.7 ↘	9.7 ↘
9.9 ↙	10.7* ↘	8.2 ←	9.2 →	9.8 ↗

beste Teiler: 73.6 (17.), 75.7 (13.), 256.4 (16.)
Trefferlage: 1.39 mm links, 0.22 mm hoch
Streuwert: 2.73, horizontal: 3.25, vertikal: 2.08

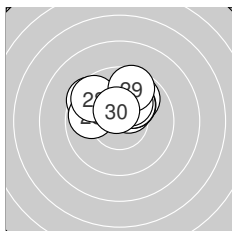

Serie 3: 99.8 (95)

9.9 ↗	10.4* ↗	9.5 ↘	10.2* ↗	9.8 ←
10.2* ↗	10.1 ↗	9.6 ↘	9.6 ↑	10.5* ↑

beste Teiler: 110.4 (30.), 139.4 (22.), 197.4 (26.)
Trefferlage: 0.12 mm links, 1.71 mm hoch
Streuwert: 1.40, horizontal: 1.84, vertikal: 0.73

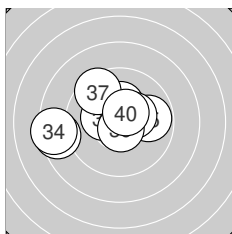

Serie 4: 98.8 (94)

10.4* ↘	8.5 ←	10.3* ↑	8.4 ←	9.8 →
10.3* ←	9.5 ↘	10.4* ↗	10.7* ↓	10.5* ↗

beste Teiler: 64.1 (39.), 110.6 (40.), 137.6 (31.)
Trefferlage: 1.18 mm links, 0.53 mm hoch
Streuwert: 2.29, horizontal: 2.98, vertikal: 1.27



Ergebnis: 385.8 (368)
Serien: 96.5 96.5 97.0 95.8
Zähler: 13 22 5 0 0 0 0 0 0 0 0
Innenzehner: 8
Weiteste: 698 (9.), 642 (23.), 561 (20.)
beste Teiler: 87.0 (1.), 93.1 (21.), 95.2 (7.)
Trefferlage: 0.25 mm rechts, 0.83 mm hoch
Streuwert: 2.49, horizontal: 2.85, vertikal: 2.08

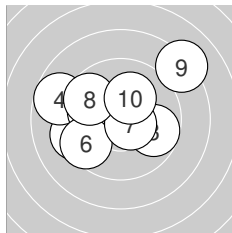
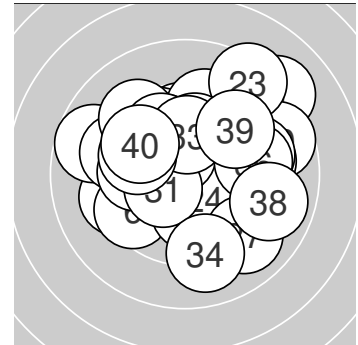

Serie 1: 96.5 (92)

10.6* ↖ 9.3 ↙ 9.7 →
 9.5 ↙ 10.6* ↘ 9.7 ↘
beste Teiler: 87.0 (1.), 95.2 (7.), 200.9 (10.)
Trefferlage: 0.78 mm links, 0.65 mm hoch
Streuwert: 2.69, horizontal: 3.26, vertikal: 1.95

8.7 ↖ 10.0 ↖
 8.2 ↗ 10.2* ↗

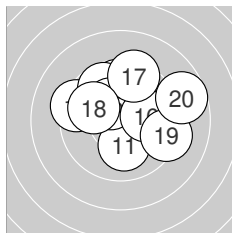

Serie 2: 96.5 (92)

10.1 ↓ 9.7 ↑ 9.3 ↖
 10.1 → 9.4 ↑ 9.9 ↖
beste Teiler: 164.9 (15.), 216.0 (11.), 224.0 (16.)
Trefferlage: 0.41 mm rechts, 1.21 mm hoch
Streuwert: 2.38, horizontal: 2.81, vertikal: 1.86

9.7 ↖ 10.3* ↖
 9.3 → 8.7 →

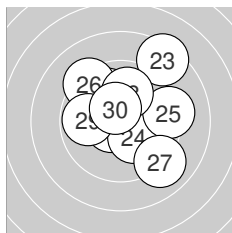

Serie 3: 97.0 (93)

10.6* ↖ 9.9 ↖ 8.4 ↗
 9.3 ↖ 9.0 ↘ 10.0 ↑
beste Teiler: 93.1 (21.), 119.7 (30.), 179.9 (24.)
Trefferlage: 0.49 mm rechts, 0.99 mm hoch
Streuwert: 2.52, horizontal: 2.55, vertikal: 2.49

10.2* ↘ 9.3 →
 9.8 ← 10.5* ↖

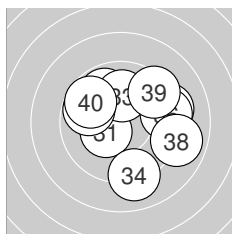

Serie 4: 95.8 (91)

10.4* ↖ 9.8 ↖ 10.0 ↑
 9.4 → 9.8 ↖ 8.9 →
beste Teiler: 149.7 (31.), 227.3 (33.), 277.7 (32.)
Trefferlage: 0.90 mm rechts, 0.49 mm hoch
Streuwert: 2.58, horizontal: 2.88, vertikal: 2.24

9.1 ↓ 9.3 →
 9.4 ↗ 9.7 ↖



Ergebnis: **386.2** (370)
 Serien: 95.6 96.6 97.5 96.5
 Zähler: 14 23 2 1 0 0 0 0 0 0
 Innenzehner: 7
 Weitester: 825 (34.), 560 (3.), 535 (15.)
 beste Teiler: 87.7 (10.), 113.0 (13.), 129.3 (20.)
 Trefferlage: 0.28 mm rechts, 0.19 mm hoch
 Streuwert: 2.53, horizontal: 2.93, vertikal: 2.04

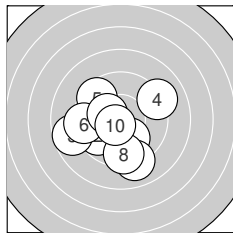
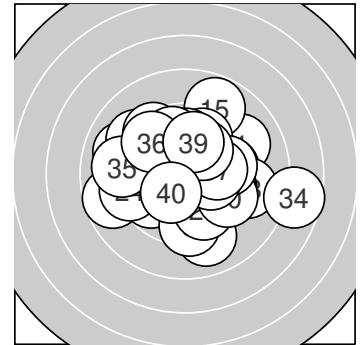

Serie 1: 95.6 (92)

10.0 ↘ 9.7 ↙ 8.7 ↙ 9.1 ↗ 9.5 ↘
 9.3 ← 9.0 ↘ 9.4 ↓ 10.3* ↖ 10.6* ↙
 beste Teiler: 87.7 (10.), 158.7 (9.), 233.0 (1.)
 Trefferlage: 0.96 mm links, 0.98 mm tief
 Streuwert: 2.57, horizontal: 2.82, vertikal: 2.30

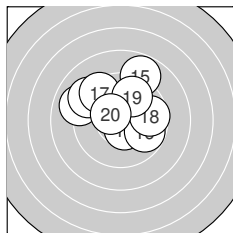

Serie 2: 96.6 (92)

9.0 ↖ 10.0 → 10.5* ↓ 9.2 ↖ 8.8 ↗
 9.8 → 9.4 ↖ 9.7 → 9.8 ↗ 10.4* ↖
 beste Teiler: 113.0 (13.), 129.3 (20.), 238.8 (12.)
 Trefferlage: 0.04 mm rechts, 1.28 mm hoch
 Streuwert: 2.43, horizontal: 2.78, vertikal: 2.01

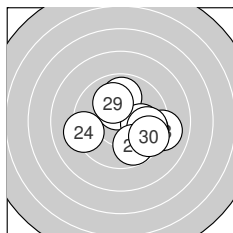

Serie 3: 97.5 (93)

10.4* ↖ 9.9 ↑ 9.1 → 9.3 ← 9.7 →
 10.0 → 9.7 → 9.8 ↘ 10.1 ↖ 9.5 ↘
 beste Teiler: 133.5 (21.), 218.7 (29.), 226.2 (26.)
 Trefferlage: 1.21 mm rechts, 0.25 mm tief
 Streuwert: 2.16, horizontal: 2.55, vertikal: 1.68

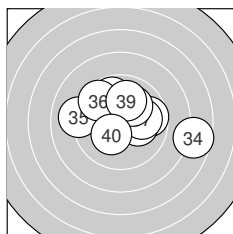

Serie 4: 96.5 (93)

9.7 → 10.2* → 9.8 ↖ 7.7 → 9.1 ←
 9.6 ↖ 10.0 → 10.1 ↗ 10.0 ↑ 10.3* ↙
 beste Teiler: 171.4 (40.), 196.1 (32.), 221.8 (38.)
 Trefferlage: 0.83 mm rechts, 0.73 mm hoch
 Streuwert: 2.70, horizontal: 3.48, vertikal: 1.58



Ergebnis: 397.8 (380)
Serien: 98.1 100.1 101.9 97.7
Zähler: 23 14 3 0 0 0 0 0 0 0 0
Innenzehner: 17
Weiteste: 612 (6.), 550 (27.), 538 (14.)
beste Teiler: 27.6 (21.), 33.6 (13.), 39.1 (26.)
Trefferlage: 0.59 mm rechts, 0.21 mm tief
Streuwert: 2.03, horizontal: 2.37, vertikal: 1.60

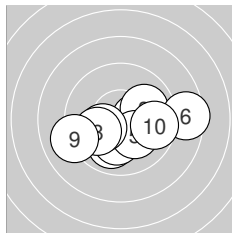
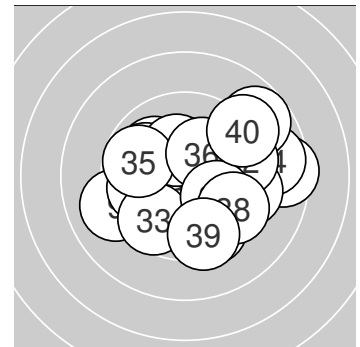

Serie 1: 98.1 (95)

9.9 ↙	10.4* →	10.0 →	10.1 ↓	10.2* ↘
8.5 →	10.2* ↙	10.0 ↙	9.1 ↙	9.7 →

beste Teiler: 143.4 (2.), 185.1 (7.), 196.0 (5.)
Trefferlage: 0.48 mm rechts, 0.86 mm tief
Streuwert: 2.26, horizontal: 3.00, vertikal: 1.10

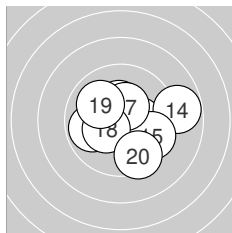

Serie 2: 100.1 (95)

10.3* →	10.4* ↑	10.8* →	8.8 →	9.7 ↘
9.9 ↙	10.4* ↑	10.3* ↙	10.0 ↘	9.5 ↘

beste Teiler: 33.6 (13.), 135.3 (17.), 148.8 (12.)
Trefferlage: 0.62 mm rechts, 0.09 mm tief
Streuwert: 1.99, horizontal: 2.37, vertikal: 1.52

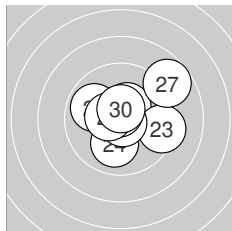

Serie 3: 101.9 (96)

10.8* ←	10.4* ↑	9.4 →	10.0 ↓	9.9 ↙
10.8* ↘	8.8 ↗	10.7* ↑	10.5* ←	10.6* ↑

beste Teiler: 27.6 (21.), 39.1 (26.), 59.2 (28.)
Trefferlage: 0.45 mm rechts, 0.39 mm hoch
Streuwert: 1.82, horizontal: 2.11, vertikal: 1.47

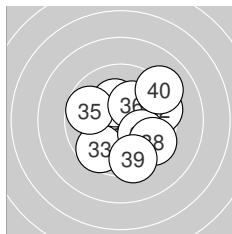

Serie 4: 97.7 (94)

10.4* ↙	9.5 →	9.6 ↙	10.3* ↑	9.7 ↙
10.2* ↗	10.0 ↘	9.5 ↘	9.4 ↓	9.1 ↗

beste Teiler: 140.3 (31.), 170.4 (34.), 177.2 (36.)
Trefferlage: 0.82 mm rechts, 0.29 mm tief
Streuwert: 2.21, horizontal: 2.30, vertikal: 2.13



Ergebnis: 392.1 (374)
Serien: 99.0 97.3 96.6 99.2
Zähler: 19 17 3 1 0 0 0 0 0 0
Innenzehner: 12
Weiteste: 786 (36.), 686 (19.), 587 (40.)
beste Teiler: 29.6 (35.), 30.8 (38.), 37.1 (11.)
Trefferlage: 0.04 mm links, 0.07 mm hoch
Streuwert: 2.42, horizontal: 2.43, vertikal: 2.41

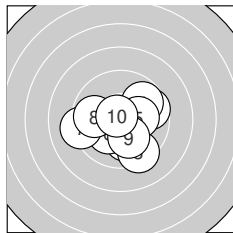
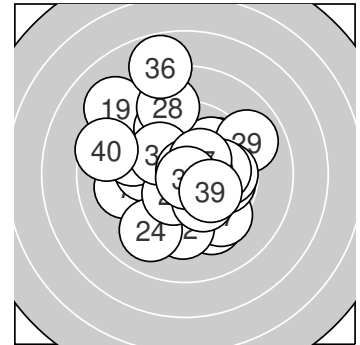

Serie 1: 99.0 (95)

10.0 ↓	9.6 →	9.4 ↓	9.8 ↗	10.2* →
10.2* ↖	9.2 ←	9.8 ←	10.1 ↓	10.7* ↖

beste Teiler: 53.2 (10.), 190.9 (5.), 196.9 (6.)
Trefferlage: 0.18 mm rechts, 0.63 mm tief
Streuwert: 2.05, horizontal: 2.37, vertikal: 1.65

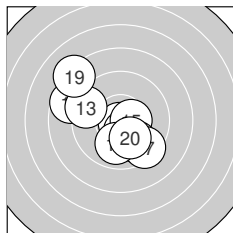

Serie 2: 97.3 (92)

10.8* ↖	8.7 ↖	9.4 ↖	10.5* ↓	10.5* →
9.8 ↘	9.4 ↘	9.9 ↓	8.2 ↖	10.1 ↓

beste Teiler: 37.1 (11.), 113.0 (15.), 121.4 (14.)
Trefferlage: 0.78 mm links, 0.31 mm tief
Streuwert: 2.64, horizontal: 2.86, vertikal: 2.41

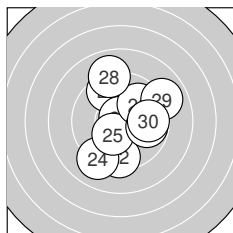

Serie 3: 96.6 (92)

9.5 ↖	9.4 ↓	10.8* ↑	9.1 ↖	10.3* ↖
9.9 ↗	9.8 →	9.0 ↑	9.0 ↗	9.8 →

beste Teiler: 41.7 (23.), 162.7 (25.), 261.6 (26.)
Trefferlage: 0.59 mm rechts, 0.28 mm hoch
Streuwert: 2.59, horizontal: 2.27, vertikal: 2.88

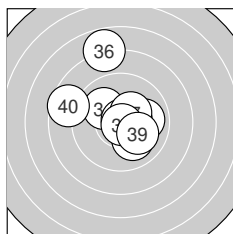

Serie 4: 99.2 (95)

10.7* ↗	10.0 ↓	10.0 →	10.0 ↖	10.8* ↗
7.8 ↑	10.4* ↗	10.8* ↓	10.1 ↘	8.6 ↖

beste Teiler: 29.6 (35.), 30.8 (38.), 57.3 (31.)
Trefferlage: 0.17 mm links, 0.94 mm hoch
Streuwert: 2.49, horizontal: 2.36, vertikal: 2.61



Ergebnis: 387.2 (372)
Serien: 96.7 96.2 100.6 93.7
Zähler: 19 17 2 1 1 0 0 0 0 0 0
Innenzehner: 13
Weiteste: 1019 (39.), 819 (12.), 638 (22.)
beste Teiler: 36.1 (27.), 64.0 (21.), 87.0 (30.)
Trefferlage: 0.60 mm links, 0.56 mm hoch
Streuwert: 2.63, horizontal: 2.93, vertikal: 2.29

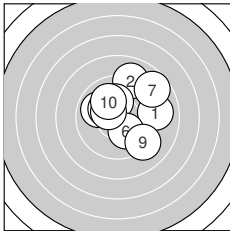
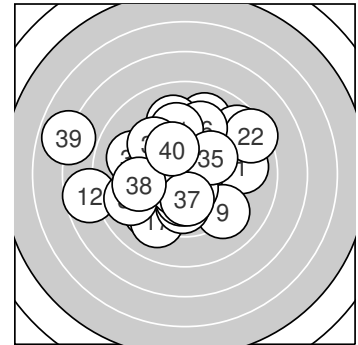

Serie 1: 96.7 (94)

9.0 → 9.0 ↑ 9.9 ↖
 10.1 ↘ 8.7 ↗ 10.4* ↖
beste Teiler: 134.1 (8.), 182.0 (5.), 195.7 (4.)
Trefferlage: 0.85 mm rechts, 1.04 mm hoch
Streuwert: 2.40, horizontal: 2.55, vertikal: 2.25

10.2* ↑ 10.2* ↖
 9.2 ↘ 10.0 ↖

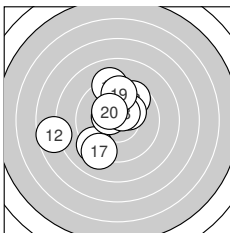

Serie 2: 96.2 (92)

9.2 ↑ 7.7 ← 9.6 ↗
 10.5* ↖ 9.1 ↘ 10.5* ↗
beste Teiler: 107.9 (18.), 113.8 (16.), 150.0 (20.)
Trefferlage: 1.23 mm links, 0.50 mm hoch
Streuwert: 2.76, horizontal: 2.82, vertikal: 2.70

10.3* ↗ 9.3 ↘
 9.6 ↑ 10.4* ↖

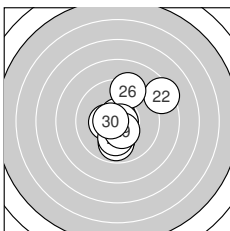

Serie 3: 100.6 (96)

10.7* ↑ 8.4 ↗ 10.0 ↓
 9.3 ↑ 10.8* → 10.1 ↓
beste Teiler: 36.1 (27.), 64.0 (21.), 87.0 (30.)
Trefferlage: 0.48 mm rechts, 0.07 mm tief
Streuwert: 2.06, horizontal: 1.91, vertikal: 2.20

9.9 ↓ 10.4* ←
 10.4* ↘ 10.6* ←

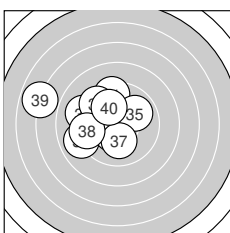

Serie 4: 93.7 (90)

9.4 ↑ 9.1 ↖ 9.0 ←
 9.5 ↖ 10.1 ↓ 9.4 ←
beste Teiler: 138.0 (34.), 208.7 (37.), 236.5 (40.)
Trefferlage: 2.51 mm links, 0.80 mm hoch
Streuwert: 2.80, horizontal: 3.31, vertikal: 2.16

10.4* ↘ 9.9 ↗
 6.9 ↖ 10.0 ↖



Ergebnis: 393.7 (376)
Serien: 96.2 98.1 98.7 100.7
Zähler: 23 12 3 2 0 0 0 0 0 0
Innenzehner: 15
Weiteste: 865 (2.), 753 (10.), 679 (12.)
beste Teiler: 6.7 (31.), 40.3 (7.), 69.3 (33.)
Trefferlage: 1.15 mm rechts, 0.53 mm hoch
Streuwert: 2.25, horizontal: 2.76, vertikal: 1.58

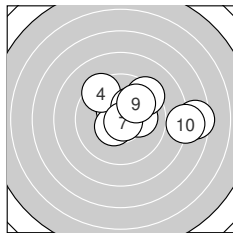
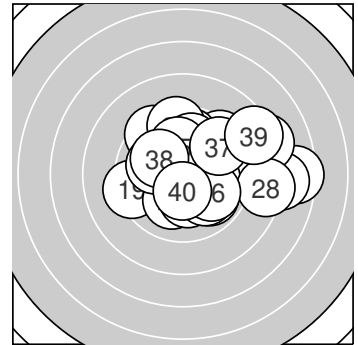

Serie 1: 96.2 (91)

10.5* ↘ 7.5 → 10.5* ↙ 9.4 ↘ 10.2* ↗
 10.1 → 10.8* ↘ 9.4 ↗ 9.9 ↗ 7.9 →

beste Teiler: 40.3 (7.), 113.8 (3.), 115.9 (1.)
Trefferlage: 2.07 mm rechts, 0.85 mm hoch
Streuwert: 2.67, horizontal: 3.52, vertikal: 1.37

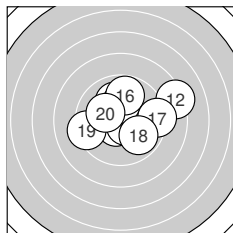

Serie 2: 98.1 (94)

10.6* ↙ 8.2 → 10.6* ↘ 10.0 ↑ 10.2* ↑
 9.8 ↑ 9.3 → 9.9 ↘ 9.3 ← 10.2* ↖

beste Teiler: 88.5 (13.), 93.4 (11.), 188.0 (15.)
Trefferlage: 0.68 mm rechts, 0.61 mm hoch
Streuwert: 2.39, horizontal: 2.94, vertikal: 1.66

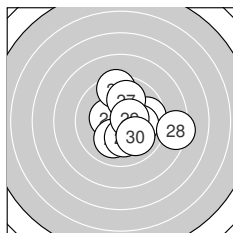

Serie 3: 98.7 (95)

10.4* ← 9.4 ↑ 9.7 → 10.1 → 10.1 ↙
 10.2* ↓ 9.9 ↑ 8.4 → 10.5* → 10.0 ↘

beste Teiler: 108.8 (29.), 143.8 (21.), 192.5 (26.)
Trefferlage: 1.26 mm rechts, 0.04 mm hoch
Streuwert: 2.10, horizontal: 2.28, vertikal: 1.90

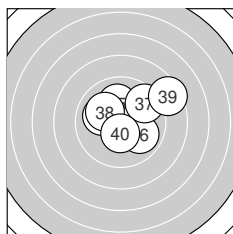

Serie 4: 100.7 (96)

10.9* ↗ 10.6* ↘ 10.7* ↖ 10.0 ← 10.1 ↑
 9.9 ↘ 9.5 ↗ 10.1 ↖ 8.5 ↗ 10.4* ↓

beste Teiler: 6.7 (31.), 69.3 (33.), 79.2 (32.)
Trefferlage: 0.60 mm rechts, 0.63 mm hoch
Streuwert: 1.95, horizontal: 2.30, vertikal: 1.51



Ergebnis: 391.7 (373)
Serien: 98.3 96.8 99.1 97.5
Zähler: 19 17 2 2 0 0 0 0 0 0
Innenzehner: 14
Weiteste: 796 (14.), 769 (1.), 567 (39.)
beste Teiler: 28.6 (30.), 42.2 (5.), 83.1 (22.)
Trefferlage: 1.05 mm links, 0.68 mm hoch
Streuwert: 2.25, horizontal: 2.47, vertikal: 2.01

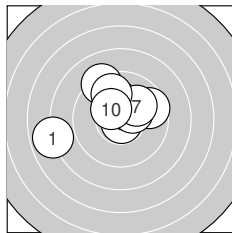
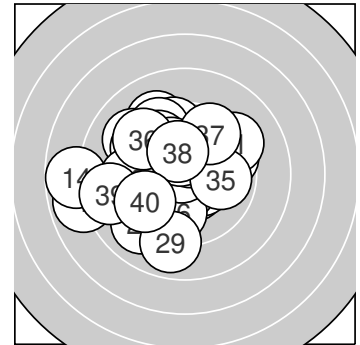

Serie 1: 98.3 (94)

7.9 ← 9.6 → 10.2* ↑
 10.4* → 10.0 ↗ 9.2 ↘
beste Teiler: 42.2 (5.), 150.3 (6.), 152.8 (10.)
Trefferlage: 0.60 mm links, 1.26 mm hoch
Streuwert: 2.32, horizontal: 2.85, vertikal: 1.63

10.1 ↑ 10.8* ↓
 9.8 ↘ 10.3* ↘

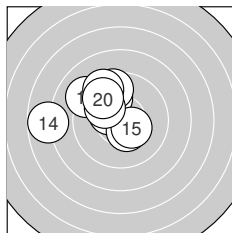

Serie 2: 96.8 (92)

10.4* ↘ 9.9 ↘ 10.4* ↓
 9.1 ↘ 9.6 ↑ 10.1 ↘
beste Teiler: 136.5 (13.), 139.5 (11.), 145.3 (15.)
Trefferlage: 1.84 mm links, 1.38 mm hoch
Streuwert: 2.17, horizontal: 2.56, vertikal: 1.70

7.8 ← 10.4* ↘
 9.4 ↘ 9.7 ↘

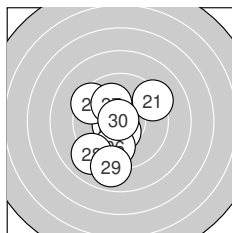

Serie 3: 99.1 (94)

9.3 ↗ 10.6* ← 10.6* ← 9.5 ↘ 10.5* ↓
 9.8 ↓ 10.1 ↘ 9.0 ↗ 8.9 ↓ 10.8* ↘

beste Teiler: 28.6 (30.), 83.1 (22.), 96.6 (23.)
Trefferlage: 0.74 mm links, 0.69 mm tief
Streuwert: 2.18, horizontal: 1.87, vertikal: 2.46

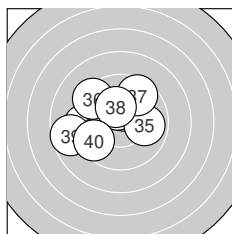

Serie 4: 97.5 (93)

10.0 ↗ 9.3 ← 10.4* ↑ 10.4* ↑ 9.9 →
 9.4 ↘ 9.6 ↗ 10.3* ↑ 8.7 ← 9.5 ↗

beste Teiler: 131.6 (33.), 140.9 (34.), 174.2 (38.)
Trefferlage: 1.03 mm links, 0.78 mm hoch
Streuwert: 2.26, horizontal: 2.70, vertikal: 1.71

