

Ergebnis: 414.5 (394)
Serien: 104.6 103.2 102.5 104.2
Zähler: 35 4 1 0 0 0 0 0 0 0 0
Innenzehner: 32
Weiteste: 582 (21.), 270 (15.), 264 (17.)
beste Teiler: 31.0 (8.), 43.6 (27.), 47.5 (40.)
Trefferlage: 0.09 mm links, 0.09 mm tief
Streuwert: 1.25, horizontal: 1.28, vertikal: 1.23

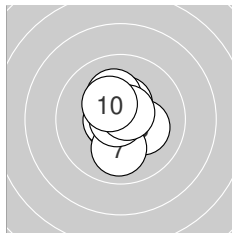
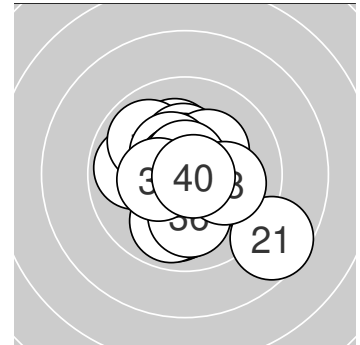

Serie 1: 104.6 (100)

10.7* ←	10.4* ↑	10.6* ←	10.2* ↑	10.2* →
10.7* ↑	10.0 ↓	10.8* ←	10.7* ↗	10.3* ↘

beste Teiler: 31.0 (8.), 62.1 (6.), 71.3 (1.)
Trefferlage: 0.07 mm links, 0.21 mm hoch
Streuwert: 1.01, horizontal: 0.79, vertikal: 1.19

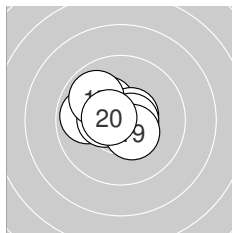

Serie 2: 103.2 (98)

10.3* ↘	10.2* ←	10.3* ←	10.6* →	9.9 ←
10.4* ←	9.9 ↘	10.6* →	10.4* ↘	10.6* ←

beste Teiler: 84.2 (18.), 91.7 (14.), 95.5 (20.)
Trefferlage: 0.86 mm links, 0.38 mm hoch
Streuwert: 1.05, horizontal: 1.29, vertikal: 0.74

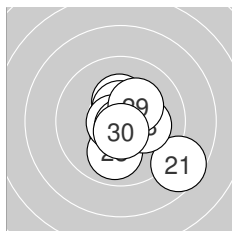

Serie 3: 102.5 (97)

8.6 ↘	10.6* ↓	9.9 ↓	10.3* ↑	10.5* ↑
10.7* ←	10.8* ↓	10.2* →	10.3* ↗	10.6* ↓

beste Teiler: 43.6 (27.), 54.9 (26.), 80.7 (22.)
Trefferlage: 0.64 mm rechts, 0.45 mm tief
Streuwert: 1.60, horizontal: 1.62, vertikal: 1.59

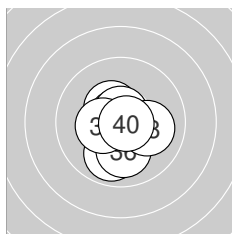

Serie 4: 104.2 (99)

10.4* ↘	10.6* ↗	10.7* ↘	10.5* ↓	9.9 ↓
10.1 ↓	10.7* ↑	10.1 →	10.4* ←	10.8* →

beste Teiler: 47.5 (40.), 51.7 (33.), 66.0 (37.)
Trefferlage: 0.10 mm links, 0.51 mm tief
Streuwert: 1.07, horizontal: 0.96, vertikal: 1.17



Ergebnis: 409.4 (390)
Serien: 100.4 101.7 103.8 103.5
Zähler: 31 8 1 0 0 0 0 0 0 0
Innenzehner: 28
Weiteste: 636 (1.), 428 (19.), 378 (8.)
beste Teiler: 28.6 (11.), 45.1 (39.), 49.2 (34.)
Trefferlage: 0.17 mm links, 0.39 mm hoch
Streuwert: 1.52, horizontal: 1.42, vertikal: 1.61

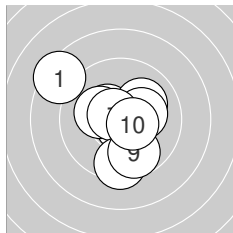
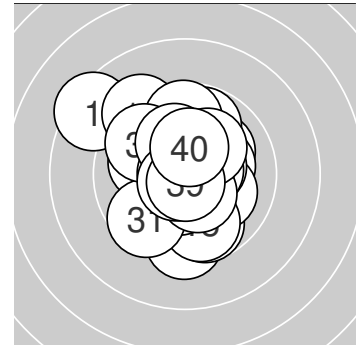

Serie 1: 100.4 (96)

8.4 ↘	10.4* ↘	10.8* ↓	10.1 ↗	10.2* ←
10.2* →	10.7* ↘	9.4 ↓	9.7 ↓	10.5* →

beste Teiler: 50.3 (3.), 74.6 (7.), 110.4 (10.)
Trefferlage: 0.29 mm links, 0.03 mm tief
Streuwert: 2.09, horizontal: 2.11, vertikal: 2.07

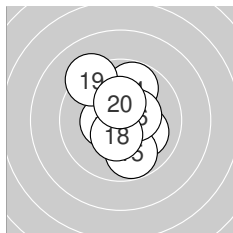

Serie 2: 101.7 (97)

10.8* ↘	10.1 ↘	10.4* ↗	9.8 ↗	9.8 ↓
10.4* →	10.5* ←	10.4* ↓	9.2 ↘	10.3* ↑

beste Teiler: 28.6 (11.), 125.6 (17.), 129.8 (18.)
Trefferlage: 0.17 mm rechts, 0.39 mm hoch
Streuwert: 1.62, horizontal: 1.30, vertikal: 1.89

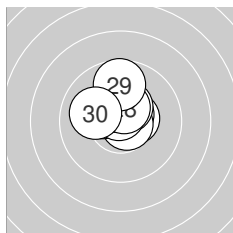

Serie 3: 103.8 (99)

10.5* →	10.6* ↗	10.7* ↘	10.4* ↗	10.3* ↘
10.7* ↑	10.4* ↘	10.5* ↑	9.7 ↑	10.0 ←

beste Teiler: 59.5 (23.), 59.6 (26.), 84.8 (22.)
Trefferlage: 0.15 mm links, 0.94 mm hoch
Streuwert: 0.97, horizontal: 1.03, vertikal: 0.90

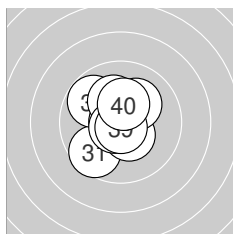

Serie 4: 103.5 (98)

9.6 ↗	10.7* ↘	9.8 ↘	10.8* ←	10.4* ↘
10.2* ↘	10.7* ↗	10.2* ↗	10.8* ↓	10.3* ↑

beste Teiler: 45.1 (39.), 49.2 (34.), 65.1 (37.)
Trefferlage: 0.43 mm links, 0.26 mm hoch
Streuwert: 1.30, horizontal: 1.15, vertikal: 1.44



Ergebnis: **413.6** (396)
 Serien: 103.0 103.1 103.2 104.3
 Zähler: 36 4 0 0 0 0 0 0 0 0
 Innenzehner: 33
 Weitester: 388 (3.), 382 (19.), 346 (6.)
 beste Teiler: 31.2 (7.), 33.6 (2.), 42.0 (1.)
 Trefferlage: 0.83 mm links, 0.35 mm tief
 Streuwert: 1.07, horizontal: 1.06, vertikal: 1.08

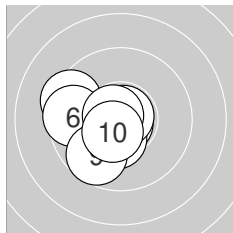
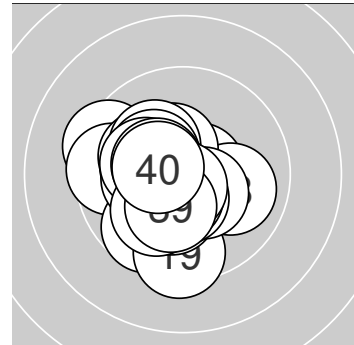

Serie 1: 103.0 (97)

10.8* ↖	10.8* ↓	9.4 ↖	10.4* ↓	10.3* ↗
9.6 ←	10.8* ↗	10.7* ↖	9.7 ↗	10.5* ↗

beste Teiler: 31.2 (7.), 33.6 (2.), 42.0 (1.)
 Trefferlage: 1.16 mm links, 0.40 mm tief
 Streuwert: 1.26, horizontal: 1.39, vertikal: 1.12

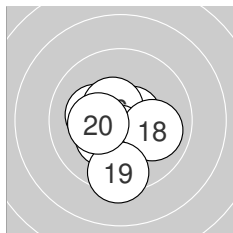

Serie 2: 103.1 (99)

10.3* ↗	10.6* →	10.8* ←	10.5* ←	10.2* ←
10.5* ↖	10.5* ↓	10.0 →	9.4 ↓	10.3* ←

beste Teiler: 44.1 (13.), 80.3 (12.), 107.9 (16.)
 Trefferlage: 0.39 mm links, 0.54 mm tief
 Streuwert: 1.28, horizontal: 1.22, vertikal: 1.33

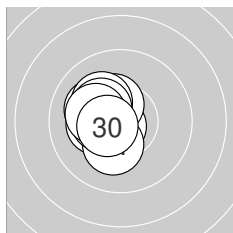

Serie 3: 103.2 (100)

10.7* ↗	10.1 ↖	10.2* ←	10.2* ↓	10.4* ↖
10.2* ↖	10.3* ↖	10.4* ←	10.2* ←	10.5* ←

beste Teiler: 52.3 (21.), 103.1 (30.), 133.9 (25.)
 Trefferlage: 1.21 mm links, 0.22 mm hoch
 Streuwert: 0.78, horizontal: 0.57, vertikal: 0.94

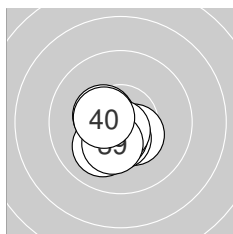

Serie 4: 104.3 (100)

10.4* ↖	10.5* ←	10.5* ↓	10.4* ↖	10.5* ↓
10.5* ↗	10.1 ↗	10.7* ↓	10.3* ↓	10.4* ←

beste Teiler: 62.5 (38.), 101.8 (36.), 107.6 (32.)
 Trefferlage: 0.55 mm links, 0.68 mm tief
 Streuwert: 0.76, horizontal: 0.72, vertikal: 0.79



Ergebnis: **418.5** (398)
 Serien: 104.6 103.7 105.5 104.7
 Zähler: 38 2 0 0 0 0 0 0 0 0
 Innenzehner: 32
 Weitester: 288 (18.), 257 (32.), 247 (16.)
 beste Teiler: 8.5 (13.), 17.0 (11.), 41.4 (33.)
 Trefferlage: 0.12 mm rechts, 0.01 mm hoch
 Streuwert: 1.02, horizontal: 1.02, vertikal: 1.02

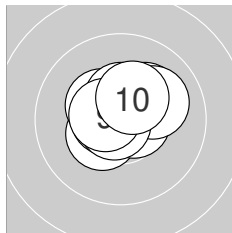
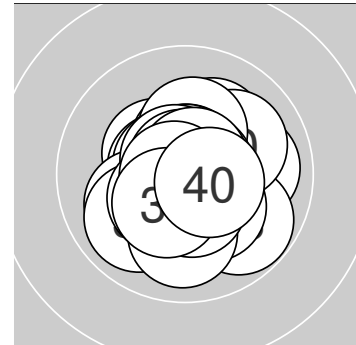

Serie 1: 104.6 (100)

10.4* ↙	10.6* ←	10.4* ↘	10.6* →	10.2* ↗
10.5* ↑	10.1 ↗	10.8* ↘	10.6* ←	10.4* ↗

beste Teiler: 45.4 (8.), 80.0 (2.), 82.2 (4.)
 Trefferlage: 0.06 mm rechts, 0.46 mm hoch
 Streuwert: 0.96, horizontal: 1.13, vertikal: 0.77

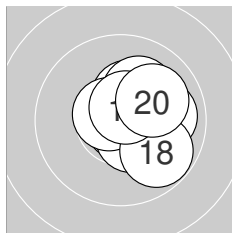

Serie 2: 103.7 (99)

10.9* ↓	10.3* ↑	10.9* ↑	10.5* ↓	10.1 ↗
10.0 →	10.6* ↘	9.8 ↘	10.6* ↑	10.0 ↗

beste Teiler: 8.5 (13.), 17.0 (11.), 80.0 (17.)
 Trefferlage: 0.84 mm rechts, 0.28 mm hoch
 Streuwert: 1.08, horizontal: 1.05, vertikal: 1.10

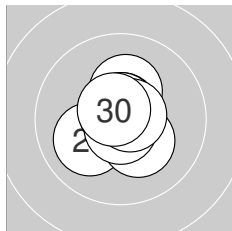

Serie 3: 105.5 (100)

10.3* ↑	10.6* ↙	10.1 ↙	10.7* ↘	10.7* ↑
10.7* ↑	10.3* ↘	10.7* ↓	10.7* →	10.7* ↘

beste Teiler: 51.2 (24.), 52.0 (28.), 61.0 (26.)
 Trefferlage: 0.12 mm links, 0.05 mm hoch
 Streuwert: 0.88, horizontal: 0.80, vertikal: 0.95

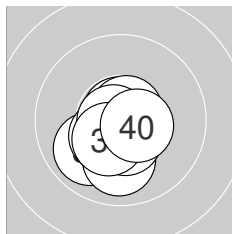

Serie 4: 104.7 (99)

10.7* ↙	9.9 ↙	10.8* ↑	10.7* ↗	10.0 ↓
10.4* ↙	10.8* ←	10.5* ↓	10.4* ↙	10.5* →

beste Teiler: 41.4 (33.), 44.7 (37.), 59.4 (34.)
 Trefferlage: 0.29 mm links, 0.74 mm tief
 Streuwert: 0.86, horizontal: 0.79, vertikal: 0.92



Ergebnis: 416.1 (396)
Serien: 104.5 104.4 102.9 104.3
Zähler: 36 4 0 0 0 0 0 0 0 0 0
Innenzehner: 33
Weiteste: 305 (11.), 273 (34.), 269 (24.)
beste Teiler: 38.1 (33.), 51.7 (5.), 54.1 (17.)
Trefferlage: 0.24 mm rechts, 0.49 mm tief
Streuwert: 1.02, horizontal: 1.08, vertikal: 0.96

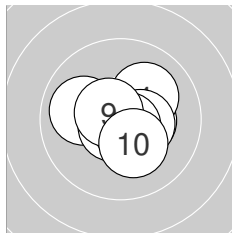
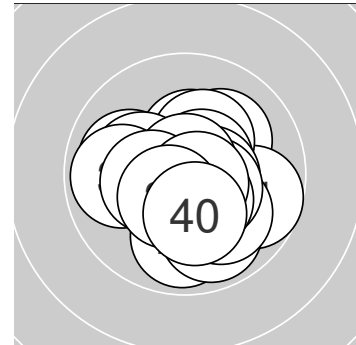

Serie 1: 104.5 (100)

10.4* →	10.7* ↗	10.0 ←	10.1 ↗	10.7* ←
10.7* ↘	10.4* →	10.7* ↘	10.6* ↖	10.2* ↘

beste Teiler: 51.7 (5.), 60.4 (8.), 71.4 (6.)
Trefferlage: 0.18 mm rechts, 0.01 mm tief
Streuwert: 1.04, horizontal: 1.23, vertikal: 0.80

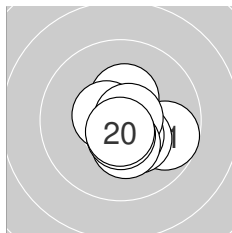

Serie 2: 104.4 (99)

9.7 →	10.4* ↑	10.3* ↘	10.6* ←	10.6* ↘
10.5* ↘	10.7* →	10.3* ↓	10.6* ↓	10.7* ↓

beste Teiler: 54.1 (17.), 75.1 (20.), 88.0 (15.)
Trefferlage: 0.50 mm rechts, 0.53 mm tief
Streuwert: 0.94, horizontal: 0.98, vertikal: 0.90

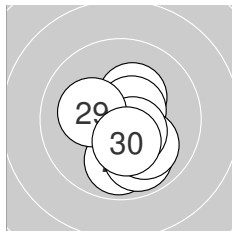

Serie 3: 102.9 (98)

10.6* ↓	9.9 ↓	10.3* ↗	9.9 ↓	10.5* ↘
10.6* ↗	10.0 ↘	10.5* ↘	10.2* ←	10.4* ↘

beste Teiler: 91.2 (21.), 91.8 (26.), 111.2 (25.)
Trefferlage: 0.38 mm rechts, 0.84 mm tief
Streuwert: 1.15, horizontal: 0.94, vertikal: 1.33

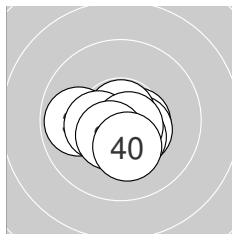

Serie 4: 104.3 (99)

10.5* →	10.4* ↘	10.8* ↑	9.9 ←	10.5* ↘
10.4* ↘	10.4* ←	10.7* ↘	10.5* ↗	10.2* ↘

beste Teiler: 38.1 (33.), 65.6 (38.), 102.8 (35.)
Trefferlage: 0.07 mm links, 0.60 mm tief
Streuwert: 0.96, horizontal: 1.21, vertikal: 0.61



Ergebnis: **413.0** (397)
 Serien: 104.0 102.5 104.0 102.5
 Zähler: 37 3 0 0 0 0 0 0 0 0
 Innenzehner: 29
 Weitester: 492 (19.), 282 (12.), 255 (36.)
 beste Teiler: 17.0 (15.), 57.0 (20.), 67.9 (28.)
 Trefferlage: 0.35 mm rechts, 0.03 mm hoch
 Streuwert: 1.25, horizontal: 1.40, vertikal: 1.09

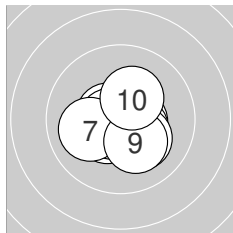
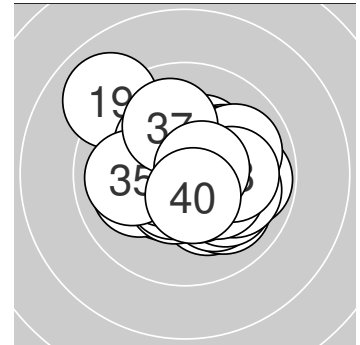

Serie 1: 104.0 (100)

10.5* →	10.4* ↙	10.6* ←	10.6* ↙	10.7* ←
10.4* ↘	10.1 ←	10.2* ↘	10.2* ↘	10.3* ↗

beste Teiler: 74.3 (5.), 87.3 (4.), 94.2 (3.)
 Trefferlage: 0.00 mm , 0.41 mm tief
 Streuwert: 1.06, horizontal: 1.22, vertikal: 0.88

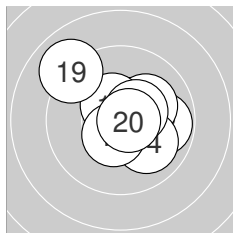

Serie 2: 102.5 (98)

10.5* ↗	9.8 →	10.1 ↗	10.0 ↘	10.9* ↖
10.5* ↖	10.5* ↙	10.5* ↗	9.0 ↖	10.7* →

beste Teiler: 17.0 (15.), 57.0 (20.), 102.6 (11.)
 Trefferlage: 0.40 mm rechts, 0.42 mm hoch
 Streuwert: 1.57, horizontal: 1.75, vertikal: 1.37

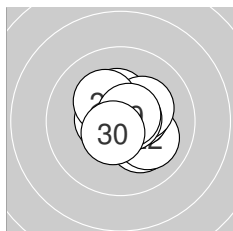

Serie 3: 104.0 (100)

10.2* ↘	10.1 ↘	10.5* ←	10.4* ↑	10.4* →
10.2* ↗	10.2* ↖	10.7* →	10.7* ↗	10.6* ↙

beste Teiler: 67.9 (28.), 71.6 (29.), 98.1 (30.)
 Trefferlage: 0.43 mm rechts, 0.15 mm hoch
 Streuwert: 1.05, horizontal: 1.09, vertikal: 1.01

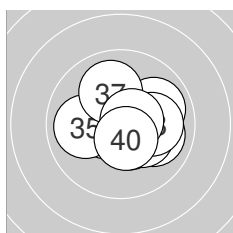

Serie 4: 102.5 (99)

10.5* ↘	10.0 ↘	10.6* ←	10.3* ↘	10.0 ←
9.9 ↗	10.0 ↑	10.1 →	10.6* →	10.5* ↘

beste Teiler: 82.8 (39.), 95.5 (33.), 107.9 (40.)
 Trefferlage: 0.59 mm rechts, 0.03 mm tief
 Streuwert: 1.34, horizontal: 1.59, vertikal: 1.03



Ergebnis: 416.7 (396)
Serien: 104.1 103.6 104.3 104.7
Zähler: 36 4 0 0 0 0 0 0 0 0
Innenzehner: 34
Weiteste: 399 (20.), 274 (25.), 258 (39.)
beste Teiler: 21.0 (5.), 36.0 (7.), 39.6 (13.)
Trefferlage: 0.09 mm rechts, 0.24 mm hoch
Streuwert: 1.10, horizontal: 1.36, vertikal: 0.75

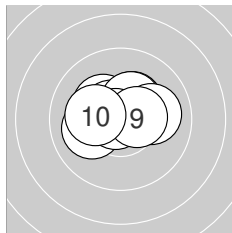
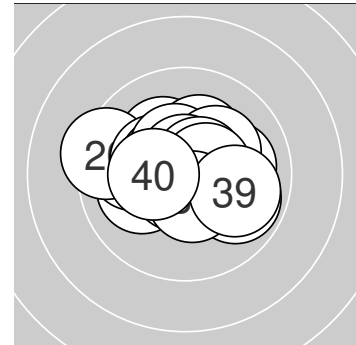

Serie 1: 104.1 (100)

10.1 ←	10.3* ↗	10.3* ↘	10.6* ↘	10.9* ↑
10.4* ↗	10.8* ←	10.0 →	10.5* →	10.2* ←

beste Teiler: 21.0 (5.), 36.0 (7.), 94.1 (4.)
Trefferlage: 0.12 mm links, 0.46 mm hoch
Streuwert: 1.09, horizontal: 1.41, vertikal: 0.61

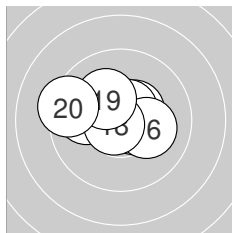

Serie 2: 103.6 (98)

10.5* ↗	10.8* →	10.8* ↗	10.5* →	10.6* ↗
10.2* →	9.9 ←	10.7* ↘	10.2* ↘	9.4 ←

beste Teiler: 39.6 (13.), 42.2 (12.), 57.6 (18.)
Trefferlage: 0.28 mm links, 0.35 mm hoch
Streuwert: 1.33, horizontal: 1.76, vertikal: 0.68

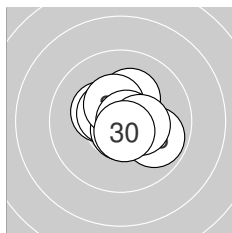

Serie 3: 104.3 (99)

10.5* ↗	10.3* ↘	10.2* ↗	10.5* ↘	9.9 →
10.7* ↓	10.4* ↗	10.8* →	10.4* →	10.6* ↓

beste Teiler: 42.1 (28.), 63.0 (26.), 79.1 (30.)
Trefferlage: 0.32 mm rechts, 0.19 mm hoch
Streuwert: 1.03, horizontal: 1.15, vertikal: 0.90

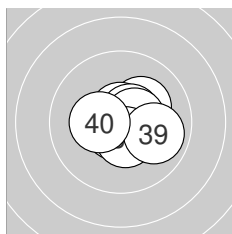

Serie 4: 104.7 (99)

10.8* ↗	10.2* ↗	10.7* ↑	10.6* ↗	10.7* ↘
10.5* ↓	10.5* →	10.5* ↓	9.9 →	10.3* ←

beste Teiler: 44.5 (31.), 68.2 (35.), 69.1 (33.)
Trefferlage: 0.48 mm rechts, 0.05 mm tief
Streuwert: 0.94, horizontal: 1.08, vertikal: 0.78



Ergebnis: 423.3 (399)
Serien: 106.4 105.4 106.3 105.2
Zähler: 39 1 0 0 0 0 0 0 0 0
Innenzehner: 38
Weiteste: 421 (16.), 221 (36.), 133 (28.)
beste Teiler: 17.8 (12.), 26.3 (30.), 26.9 (10.)
Trefferlage: 0.04 mm rechts, 0.14 mm hoch
Streuwert: 0.81, horizontal: 0.83, vertikal: 0.79

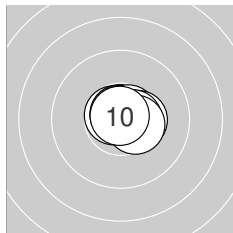
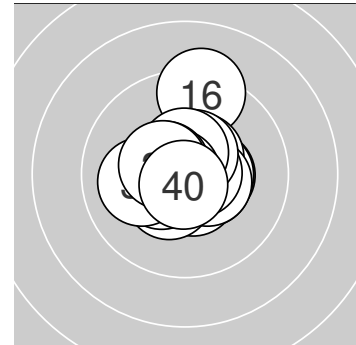

Serie 1: 106.4 (100)

10.7* ↖	10.8* ↑	10.6* →	10.8* ↑	10.5* →
10.7* ↗	10.4* →	10.6* →	10.5* →	10.8* ↑

beste Teiler: 26.9 (10.), 34.0 (4.), 39.0 (2.)
Trefferlage: 0.52 mm rechts, 0.08 mm hoch
Streuwert: 0.49, horizontal: 0.64, vertikal: 0.28

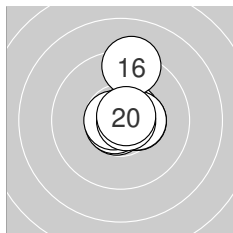

Serie 2: 105.4 (99)

10.6* ↗	10.9* ↑	10.5* →	10.5* →	10.7* ↘
9.3 ↑	10.7* ↙	10.7* ←	10.8* →	10.7* ↗

beste Teiler: 17.8 (12.), 42.5 (19.), 51.4 (15.)
Trefferlage: 0.36 mm rechts, 0.42 mm hoch
Streuwert: 1.05, horizontal: 0.66, vertikal: 1.33

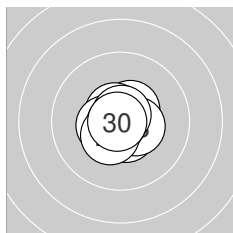

Serie 3: 106.3 (100)

10.5* ↗	10.6* ↓	10.5* →	10.6* ↖	10.8* ←
10.5* ←	10.8* ↙	10.4* ↘	10.8* ↑	10.8* ←

beste Teiler: 26.3 (30.), 33.3 (25.), 37.1 (27.)
Trefferlage: 0.09 mm links, 0.08 mm tief
Streuwert: 0.66, horizontal: 0.70, vertikal: 0.63

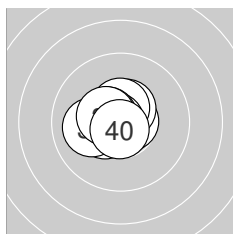

Serie 4: 105.2 (100)

10.4* ←	10.7* →	10.5* ↑	10.5* ←	10.5* ↑
10.1 ←	10.8* ←	10.5* ↖	10.5* ↖	10.7* ↓

beste Teiler: 46.0 (37.), 54.5 (40.), 65.2 (32.)
Trefferlage: 0.61 mm links, 0.16 mm hoch
Streuwert: 0.74, horizontal: 0.87, vertikal: 0.59



Ergebnis: **413.5** (394)
 Serien: 103.4 104.7 102.1 103.3
 Zähler: 34 6 0 0 0 0 0 0 0 0
 Innenzehner: 31
 Weitesten: 365 (1.), 354 (22.), 320 (25.)
 beste Teiler: 32.5 (17.), 34.0 (19.), 54.3 (32.)
 Trefferlage: 0.18 mm rechts, 0.00 mm
 Streuwert: 1.25, horizontal: 1.54, vertikal: 0.87

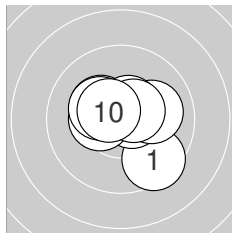
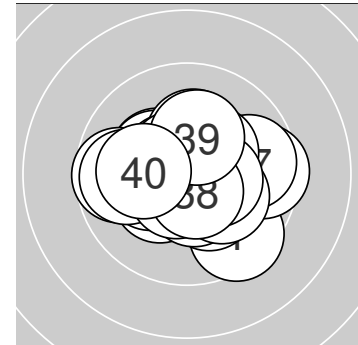

Serie 1: 103.4 (99)

9.5 ↘	10.7* ↗	10.3* ↖	10.6* →	10.4* ←
10.1 →	10.5* ↗	10.5* ↗	10.3* ↖	10.5* ↖

beste Teiler: 56.6 (2.), 82.0 (4.), 102.0 (7.)
 Trefferlage: 0.19 mm rechts, 0.21 mm hoch
 Streuwert: 1.28, horizontal: 1.44, vertikal: 1.10

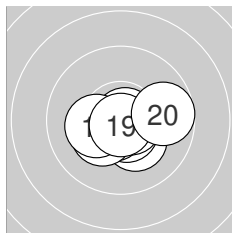

Serie 2: 104.7 (99)

10.6* ↘	10.3* ↘	10.6* ↘	10.6* ↗	10.7* →
10.3* ↗	10.8* →	10.3* ←	10.8* ↓	9.7 →

beste Teiler: 32.5 (17.), 34.0 (19.), 71.4 (15.)
 Trefferlage: 0.24 mm rechts, 0.50 mm tief
 Streuwert: 0.99, horizontal: 1.30, vertikal: 0.53

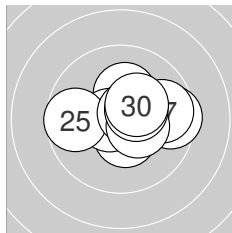

Serie 3: 102.1 (97)

10.2* ↑	9.5 →	10.5* ↓	10.6* ←	9.7 ←
10.7* ↗	9.8 →	10.4* ↘	10.4* ↗	10.3* ↗

beste Teiler: 73.6 (26.), 77.3 (24.), 122.8 (23.)
 Trefferlage: 0.72 mm rechts, 0.28 mm hoch
 Streuwert: 1.44, horizontal: 1.87, vertikal: 0.82

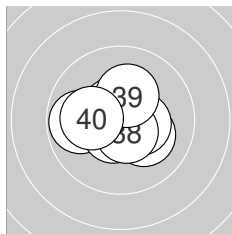

Serie 4: 103.3 (99)

10.6* ↘	10.7* ↑	10.2* ↘	10.1 ←	10.4* →
9.8 ←	10.6* ↗	10.6* ↘	10.2* ↑	10.1 ←

beste Teiler: 54.3 (32.), 91.2 (38.), 92.9 (31.)
 Trefferlage: 0.40 mm links, 0.02 mm hoch
 Streuwert: 1.22, horizontal: 1.50, vertikal: 0.84



Ergebnis: **385.8** (363)
 Serien: 97.0 92.2 98.9 97.7
 Zähler: 11 24 3 1 1 0 0 0 0 0 0
 Innenzehner: 10
 Weitester: 1069 (14.), 788 (11.), 728 (10.)
 beste Teiler: 55.9 (27.), 66.4 (40.), 106.7 (33.)
 Trefferlage: 1.36 mm rechts, 0.34 mm tief
 Streuwert: 2.54, horizontal: 3.00, vertikal: 1.96

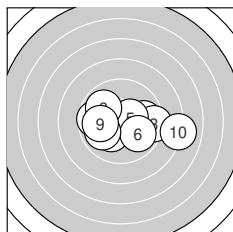
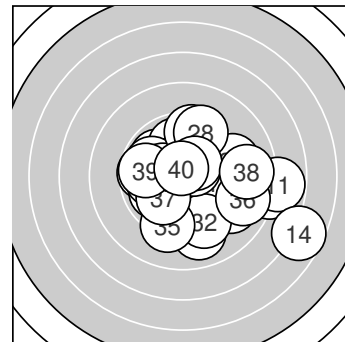

Serie 1: 97.0 (91)

10.2* ↙	9.8 →	9.3 →	9.7 ←	10.4* →
9.9 ↘	9.9 ↙	9.9 ↘	9.9 ←	8.0 →

beste Teiler: 128.5 (5.), 192.2 (1.), 254.6 (9.)
 Trefferlage: 0.62 mm rechts, 0.35 mm tief
 Streuwert: 2.55, horizontal: 3.44, vertikal: 1.07

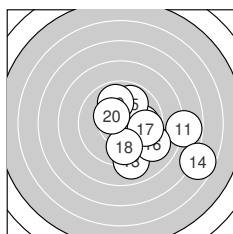

Serie 2: 92.2 (86)

7.8 →	9.9 →	9.0 ↓	6.7 →	9.9 ↑
9.1 ↘	9.7 →	9.8 ↓	9.9 ↑	10.4* ↘

beste Teiler: 143.6 (20.), 259.0 (12.), 264.6 (19.)
 Trefferlage: 2.82 mm rechts, 1.01 mm tief
 Streuwert: 3.10, horizontal: 3.50, vertikal: 2.64

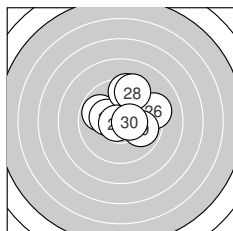

Serie 3: 98.9 (93)

9.8 ↖	9.7 →	10.3* ←	9.9 →	9.5 ↑
9.2 →	10.7* ↙	9.4 ↑	9.9 →	10.5* →

beste Teiler: 55.9 (27.), 111.5 (30.), 173.7 (23.)
 Trefferlage: 1.05 mm rechts, 0.86 mm hoch
 Streuwert: 1.88, horizontal: 2.12, vertikal: 1.62

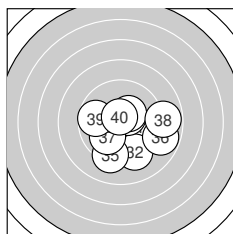

Serie 4: 97.7 (93)

10.2* →	9.3 ↓	10.5* ↗	10.4* ↗	9.3 ↓
8.8 →	10.0 ↙	8.8 →	9.7 ←	10.7* ↑

beste Teiler: 66.4 (40.), 106.7 (33.), 144.3 (34.)
 Trefferlage: 0.96 mm rechts, 0.88 mm tief
 Streuwert: 2.32, horizontal: 2.70, vertikal: 1.87



Ergebnis: **411.2** (393)
 Serien: 100.5 104.8 103.3 102.6
 Zähler: 33 7 0 0 0 0 0 0 0 0 0
 Innenzehner: 30
 Weitestе: 401 (5.), 377 (3.), 363 (10.)
 beste Teiler: 21.0 (20.), 65.6 (32.), 67.1 (12.)
 Trefferlage: 0.41 mm links, 0.62 mm tief
 Streuwert: 1.27, horizontal: 1.51, vertikal: 0.96

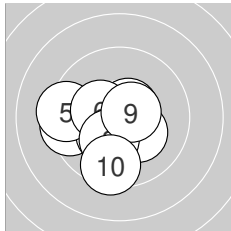
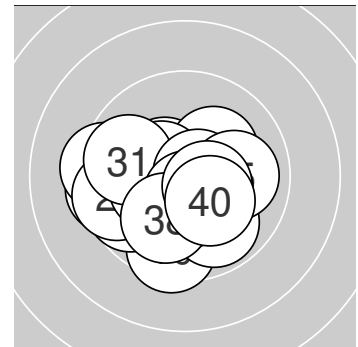

Serie 1: 100.5 (97)

10.1 ←	10.6* ↗	9.4 ←	10.3* ↙	9.3 ←
10.3* ↖	10.2* ↘	10.2* ↙	10.6* →	9.5 ↓

beste Teiler: 92.6 (2.), 94.0 (9.), 152.5 (6.)
 Trefferlage: 1.08 mm links, 0.61 mm tief
 Streuwert: 1.59, horizontal: 1.81, vertikal: 1.34

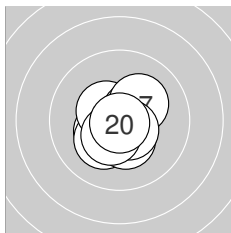

Serie 2: 104.8 (100)

10.4* ↙	10.7* ↓	10.2* ↗	10.5* ↘	10.5* ↗
10.4* ↓	10.2* ↗	10.6* ↘	10.4* ↙	10.9* ↓

beste Teiler: 21.0 (20.), 67.1 (12.), 99.7 (18.)
 Trefferlage: 0.05 mm links, 0.38 mm tief
 Streuwert: 0.93, horizontal: 0.93, vertikal: 0.94

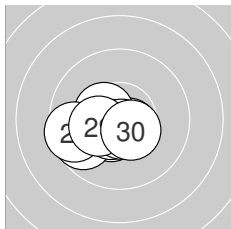

Serie 3: 103.3 (98)

10.5* ↙	10.6* ←	10.6* ↘	9.7 ←	10.4* ↖
10.6* ↙	9.5 ←	10.6* ↓	10.3* ←	10.5* ↘

beste Teiler: 76.4 (28.), 91.9 (23.), 99.4 (26.)
 Trefferlage: 0.94 mm links, 0.66 mm tief
 Streuwert: 1.03, horizontal: 1.36, vertikal: 0.53

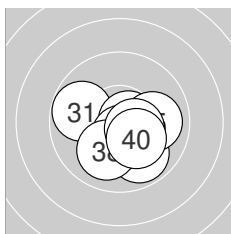

Serie 4: 102.6 (98)

9.8 ←	10.7* →	9.9 ↘	10.4* ↓	10.0 →
10.6* ↓	10.4* ↘	10.0 ↙	10.5* ↘	10.3* ↘

beste Teiler: 65.6 (32.), 98.3 (36.), 121.3 (39.)
 Trefferlage: 0.43 mm rechts, 0.82 mm tief
 Streuwert: 1.25, horizontal: 1.48, vertikal: 0.98



Ergebnis: **419.1** (397)
 Serien: 105.0 104.3 104.9 104.9
 Zähler: 37 3 0 0 0 0 0 0 0 0 0
 Innenzehner: 35
 Weitestе: 285 (19.), 272 (35.), 263 (10.)
 beste Teiler: 37.6 (38.), 43.2 (34.), 44.0 (12.)
 Trefferlage: 0.64 mm rechts, 0.05 mm tief
 Streuwert: 0.86, horizontal: 0.77, vertikal: 0.95

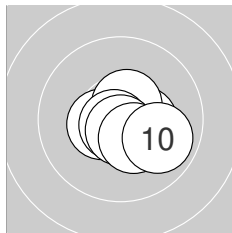
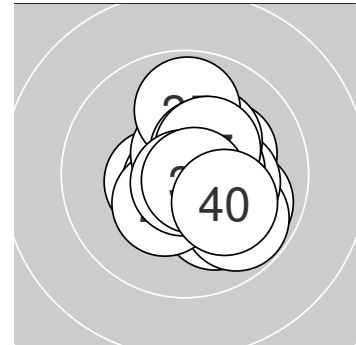

Serie 1: 105.0 (99)

10.6* ←	10.5* ←	10.4* →	10.5* ↘	10.7* ↘
10.6* ↑	10.7* ↙	10.7* ↓	10.4* ↘	9.9 ↘

beste Teiler: 54.5 (7.), 59.0 (5.), 70.0 (8.)
 Trefferlage: 0.40 mm rechts, 0.41 mm tief
 Streuwert: 0.87, horizontal: 1.07, vertikal: 0.60

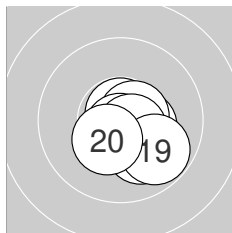

Serie 2: 104.3 (99)

10.4* →	10.8* ↑	10.6* →	10.2* ↓	10.7* ↓
10.1 ↘	10.7* ↓	10.6* ↘	9.8 ↘	10.4* ↙

beste Teiler: 44.0 (12.), 54.2 (17.), 75.5 (15.)
 Trefferlage: 0.67 mm rechts, 0.79 mm tief
 Streuwert: 0.83, horizontal: 0.86, vertikal: 0.81

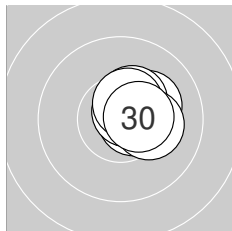

Serie 3: 104.9 (100)

10.6* →	10.2* ↗	10.5* ↗	10.6* ↗	10.7* ↗
10.4* ↗	10.7* ↗	10.5* ↗	10.2* →	10.5* →

beste Teiler: 63.8 (27.), 67.2 (25.), 79.3 (24.)
 Trefferlage: 0.91 mm rechts, 0.46 mm hoch
 Streuwert: 0.48, horizontal: 0.49, vertikal: 0.47

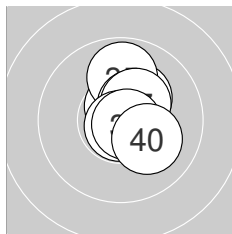

Serie 4: 104.9 (99)

10.6* ↑	10.7* →	10.3* ↗	10.8* →	9.9 ↑
10.5* ↗	10.4* ↗	10.8* ↓	10.8* ↘	10.1 ↘

beste Teiler: 37.6 (38.), 43.2 (34.), 48.2 (39.)
 Trefferlage: 0.59 mm rechts, 0.52 mm hoch
 Streuwert: 0.87, horizontal: 0.55, vertikal: 1.11



Ergebnis: 416.6 (396)
Serien: 104.7 103.0 104.0 104.9
Zähler: 36 4 0 0 0 0 0 0 0 0 0
Innenzehner: 33
Weiteste: 347 (16.), 277 (25.), 270 (31.)
beste Teiler: 1.4 (38.), 37.3 (27.), 38.0 (10.)
Trefferlage: 0.50 mm links, 0.59 mm hoch
Streuwert: 0.96, horizontal: 1.02, vertikal: 0.89

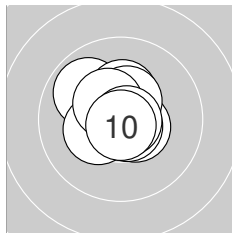
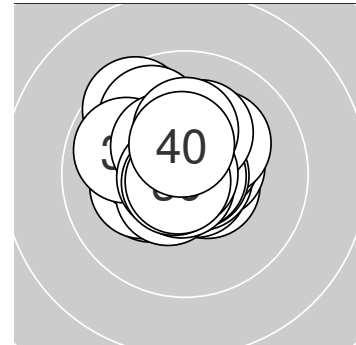

Serie 1: 104.7 (99)

10.5* ↘	10.5* ←	9.9 ↘	10.3* ↑	10.3* ↙
10.7* ↘	10.5* ↑	10.4* ↘	10.8* →	10.8* ↓

beste Teiler: 38.0 (10.), 40.5 (9.), 62.9 (6.)
Trefferlage: 0.31 mm links, 0.33 mm hoch
Streuwert: 0.95, horizontal: 0.98, vertikal: 0.92

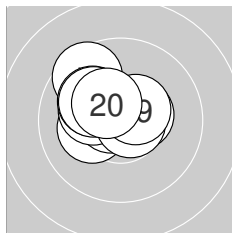

Serie 2: 103.0 (99)

10.2* ←	10.5* →	10.7* ←	10.2* ←	10.7* →
9.6 ↘	10.1 ↘	10.1 ↘	10.5* →	10.4* ↘

beste Teiler: 62.8 (13.), 64.7 (15.), 117.6 (19.)
Trefferlage: 0.79 mm links, 0.74 mm hoch
Streuwert: 1.10, horizontal: 1.27, vertikal: 0.91

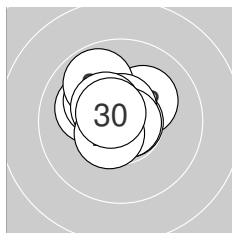

Serie 3: 104.0 (99)

10.1 ↘	10.2* ↗	10.8* →	10.2* ↘	9.8 ↘
10.6* ↑	10.8* →	10.4* ↘	10.5* ↗	10.6* ↘

beste Teiler: 37.3 (27.), 48.3 (23.), 79.3 (26.)
Trefferlage: 0.47 mm links, 0.70 mm hoch
Streuwert: 0.97, horizontal: 1.04, vertikal: 0.89

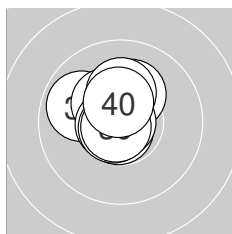

Serie 4: 104.9 (99)

9.9 ↘	10.2* ↑	10.8* ↓	10.3* ↘	10.7* ←
10.2* ↑	10.7* ↙	10.9* ↗	10.8* ↙	10.4* ↑

beste Teiler: 1.4 (38.), 42.4 (39.), 49.0 (33.)
Trefferlage: 0.44 mm links, 0.58 mm hoch
Streuwert: 0.89, horizontal: 0.84, vertikal: 0.93



LG 40 ZR

StandNr: 140

Tamerle,, Anton #70110020

Senioren_3fm

Wertung

StartNr: 80

03.03.2024 11:42

SG_Nassereith

Ergebnis: **412.0** (394)
 Serien: 100.7 104.2 103.6 103.5
 Zähler: 36 3 0 1 0 0 0 0 0 0
 Innenzehner: 34
 Weitester: 803 (3.), 497 (15.), 356 (36.)
 beste Teiler: 26.4 (8.), 44.4 (1.), 53.8 (9.)
 Trefferlage: 0.59 mm rechts, 0.02 mm tief
 Streuwert: 1.45, horizontal: 1.75, vertikal: 1.07

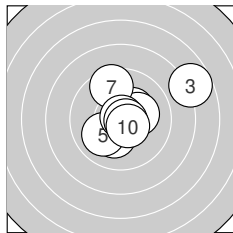
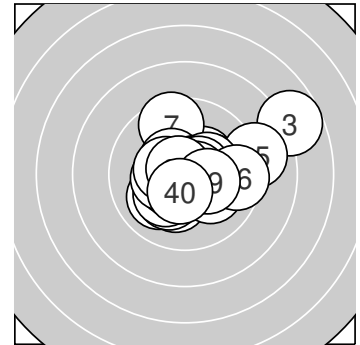

Serie 1: 100.7 (96)

10.8* →	10.3* ↗	7.7 →	10.2* ↓	10.0 ↙
10.2* →	9.5 ↑	10.8* ↗	10.7* →	10.5* ↘

beste Teiler: 26.4 (8.), 44.4 (1.), 53.8 (9.)
 Trefferlage: 0.86 mm rechts, 0.46 mm hoch
 Streuwert: 2.16, horizontal: 2.47, vertikal: 1.80

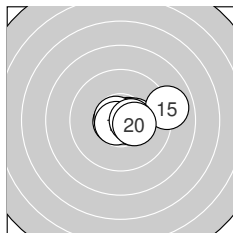

Serie 2: 104.2 (99)

10.6* →	10.7* →	10.5* →	10.4* →	9.0 →
10.7* ←	10.7* ↖	10.7* ↙	10.5* →	10.4* →

beste Teiler: 54.6 (18.), 55.0 (17.), 56.2 (12.)
 Trefferlage: 0.95 mm rechts, 0.04 mm hoch
 Streuwert: 1.16, horizontal: 1.56, vertikal: 0.48

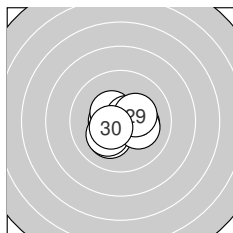

Serie 3: 103.6 (100)

10.2* ↙	10.5* ←	10.2* →	10.4* ↖	10.5* →
10.6* ↗	10.2* ↙	10.2* →	10.3* →	10.5* ↙

beste Teiler: 79.4 (26.), 106.6 (25.), 109.0 (22.)
 Trefferlage: 0.14 mm rechts, 0.28 mm tief
 Streuwert: 1.11, horizontal: 1.34, vertikal: 0.81

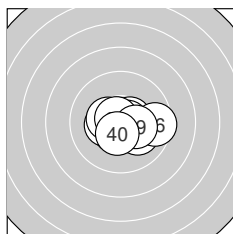

Serie 4: 103.5 (99)

10.5* ↙	10.1 ↘	10.5* →	10.7* →	10.3* ←
9.5 →	10.4* ←	10.7* ↖	10.3* →	10.5* ↓

beste Teiler: 58.1 (38.), 69.0 (34.), 101.5 (33.)
 Trefferlage: 0.42 mm rechts, 0.31 mm tief
 Streuwert: 1.20, horizontal: 1.58, vertikal: 0.61

