

Ergebnis: **419.8** (400)
 Serien: 104.8 105.3 105.5 104.2
 Zähler: 40 0 0 0 0 0 0 0 0 0
 Innenzehner: 38
 Weitestе: 234 (38.), 218 (13.), 172 (40.)
 beste Teiler: 15.0 (15.), 21.0 (25.), 21.2 (24.)
 Trefferlage: 0.42 mm rechts, 0.05 mm hoch
 Streuwert: 0.85, horizontal: 0.74, vertikal: 0.95

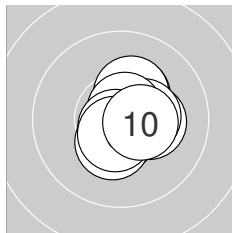
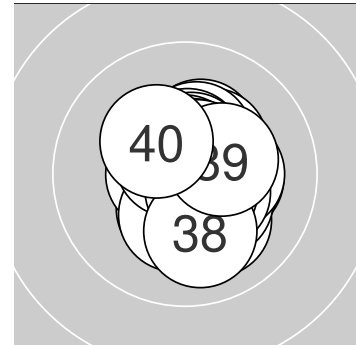

Serie 1: 104.8 (100)

10.3* →	10.3* ↗	10.6* ↓	10.3* ↗	10.4* ↓
10.4* →	10.7* ↗	10.7* ↘	10.6* ↓	10.5* →

beste Teiler: 55.7 (8.), 60.4 (7.), 93.6 (3.)
 Trefferlage: 0.46 mm rechts, 0.03 mm tief
 Streuwert: 0.87, horizontal: 0.77, vertikal: 0.97

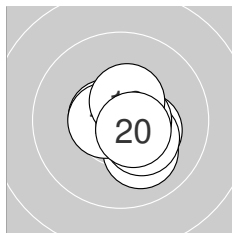

Serie 2: 105.3 (100)

10.8* ←	10.3* ↘	10.1 ↘	10.3* ↘	10.9* ↑
10.6* ←	10.6* →	10.6* ←	10.5* ↑	10.6* ↘

beste Teiler: 15.0 (15.), 45.7 (11.), 79.0 (17.)
 Trefferlage: 0.35 mm rechts, 0.25 mm tief
 Streuwert: 0.84, horizontal: 0.87, vertikal: 0.80

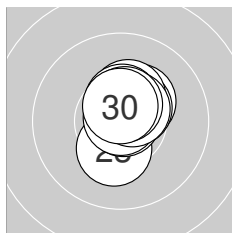

Serie 3: 105.5 (100)

10.3* ↗	10.5* ↗	10.3* ↓	10.9* ↗	10.9* ↑
10.4* ↑	10.5* ↑	10.6* ↗	10.5* ↑	10.6* ↑

beste Teiler: 21.0 (25.), 21.2 (24.), 90.0 (30.)
 Trefferlage: 0.31 mm rechts, 0.58 mm hoch
 Streuwert: 0.69, horizontal: 0.44, vertikal: 0.88

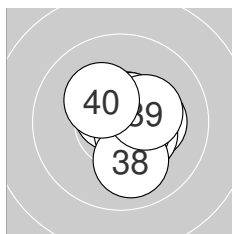

Serie 4: 104.2 (100)

10.7* ↘	10.6* ↑	10.6* ↗	10.3* →	10.4* ↘
10.4* ↘	10.6* ↘	10.0 ↓	10.3* →	10.3* ↘

beste Teiler: 74.9 (31.), 80.7 (32.), 85.7 (33.)
 Trefferlage: 0.57 mm rechts, 0.05 mm tief
 Streuwert: 0.97, horizontal: 0.87, vertikal: 1.06



Ergebnis: 411.7 (395)
Serien: 103.4 101.6 102.6 104.1
Zähler: 35 5 0 0 0 0 0 0 0 0
Innenzehner: 26
Weiteste: 346 (26.), 329 (20.), 292 (19.)
beste Teiler: 9.8 (31.), 12.5 (1.), 33.6 (33.)
Trefferlage: 0.10 mm links, 0.19 mm hoch
Streuwert: 1.30, horizontal: 1.42, vertikal: 1.17

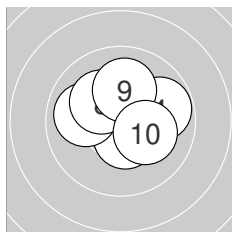
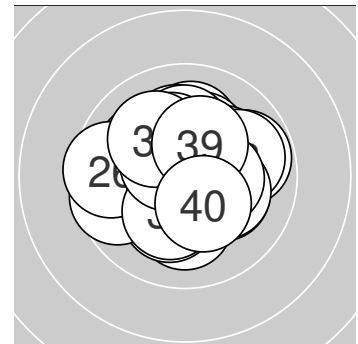

Serie 1: 103.4 (99)

10.9* ↙	10.3* ↘	10.6* ↘	9.8 →	10.8* ←
10.5* ↓	10.0 ←	10.2* ↘	10.1 ↑	10.2* ↘

beste Teiler: 12.5 (1.), 38.0 (5.), 96.2 (3.)
Trefferlage: 0.16 mm rechts, 0.30 mm hoch
Streuwert: 1.30, horizontal: 1.53, vertikal: 1.01

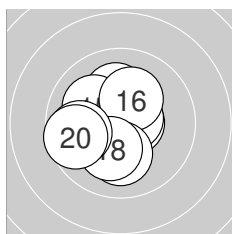

Serie 2: 101.6 (98)

10.6* →	10.1 ↑	10.6* ↘	10.3* ↙	10.1 ↘
10.2* ↗	10.1 ↓	10.2* ↙	9.8 ←	9.6 ←

beste Teiler: 82.7 (13.), 83.0 (11.), 156.1 (14.)
Trefferlage: 0.73 mm links, 0.17 mm tief
Streuwert: 1.45, horizontal: 1.46, vertikal: 1.45

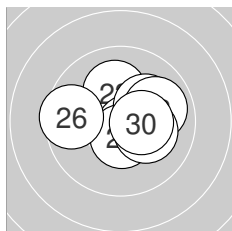

Serie 3: 102.6 (98)

10.5* ↘	10.6* ↘	10.1 ↑	10.7* ↘	10.5* ↓
9.6 ←	10.1 ↗	9.9 →	10.2* ↘	10.4* →

beste Teiler: 69.0 (24.), 76.2 (22.), 107.3 (25.)
Trefferlage: 0.46 mm rechts, 0.19 mm hoch
Streuwert: 1.37, horizontal: 1.70, vertikal: 0.93

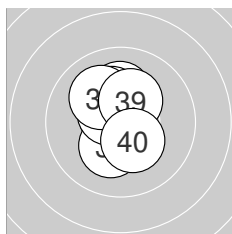

Serie 4: 104.1 (100)

10.9* ↙	10.7* ↘	10.8* ↙	10.2* ↙	10.1 ↑
10.5* ↘	10.2* ↑	10.1 ↘	10.3* ↗	10.3* ↘

beste Teiler: 9.8 (31.), 33.6 (33.), 70.6 (32.)
Trefferlage: 0.30 mm links, 0.46 mm hoch
Streuwert: 1.03, horizontal: 0.68, vertikal: 1.28



Ergebnis: **407.7** (390)
Serien: 103.3 102.8 102.8 98.8
Zähler: 30 10 0 0 0 0 0 0 0 0
Innenzehner: 22
Weiteste: 477 (32.), 460 (39.), 365 (35.)
beste Teiler: 26.9 (20.), 31.3 (17.), 36.0 (10.)
Trefferlage: 0.47 mm rechts, 0.08 mm hoch
Streuwert: 1.52, horizontal: 1.46, vertikal: 1.58

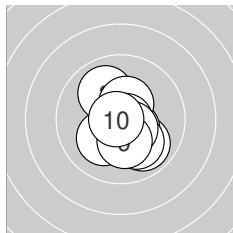
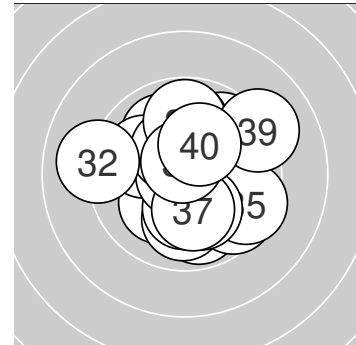

Serie 1: 103.3 (99)

10.1 ↙	10.0 ↘	9.9 ↘	10.5* ↘	10.4* ↑
10.1 ↘	10.8* ↘	10.5* ↘	10.2* ↓	10.8* ←

beste Teiler: 36.0 (10.), 41.4 (7.), 110.3 (8.)
Trefferlage: 0.30 mm rechts, 0.53 mm tief
Streuwert: 1.21, horizontal: 1.02, vertikal: 1.37

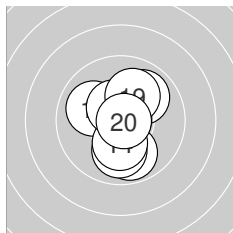

Serie 2: 102.8 (98)

10.0 ↖	9.9 ↓	10.0 ↓	10.2* ↓	9.9 ↗
10.6* ↑	10.8* ↗	10.5* ↘	10.1 ↑	10.8* ↘

beste Teiler: 26.9 (20.), 31.3 (17.), 89.2 (16.)
Trefferlage: 0.10 mm rechts, 0.01 mm tief
Streuwert: 1.42, horizontal: 1.04, vertikal: 1.72

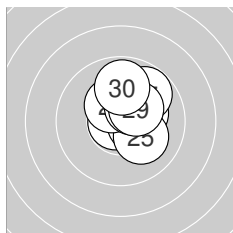

Serie 3: 102.8 (98)

10.2* ↗	10.4* ↘	10.8* ←	10.5* ↗	10.1 ↘
10.4* ↘	9.8 ↗	10.4* ↗	10.3* ↗	9.9 ↑

beste Teiler: 42.9 (23.), 119.3 (24.), 141.9 (22.)
Trefferlage: 0.70 mm rechts, 0.87 mm hoch
Streuwert: 1.10, horizontal: 1.01, vertikal: 1.18

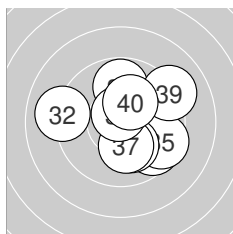

Serie 4: 98.8 (95)

9.8 ↑	9.0 ←	10.6* ↘	9.6 ↘	9.5 ↘
10.1 ↘	10.2* ↓	10.7* ↑	9.1 ↗	10.2* ↑

beste Teiler: 69.6 (38.), 81.0 (33.), 179.3 (40.)
Trefferlage: 0.77 mm rechts, 0.02 mm hoch
Streuwert: 2.15, horizontal: 2.40, vertikal: 1.87



Ergebnis: 405.1 (388)
Serien: 100.8 101.9 101.2 101.2
Zähler: 28 12 0 0 0 0 0 0 0 0
Innenzehner: 23
Weiteste: 496 (9.), 481 (2.), 457 (22.)
beste Teiler: 13.0 (1.), 47.0 (11.), 50.8 (39.)
Trefferlage: 0.36 mm links, 0.11 mm hoch
Streuwert: 1.72, horizontal: 2.07, vertikal: 1.27

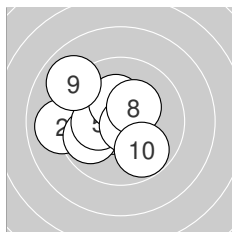
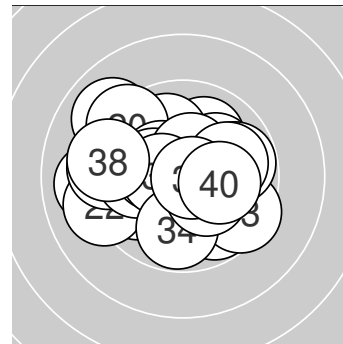

Serie 1: 100.8 (96)

10.9* →	9.0 ←	10.7* ↗	9.9 ←	10.2* ←
10.3* ↑	10.7* ↘	10.3* ↗	9.0 ↘	9.8 ↘

beste Teiler: 13.0 (1.), 59.9 (7.), 69.4 (3.)
Trefferlage: 1.04 mm links, 0.09 mm hoch
Streuwert: 1.86, horizontal: 2.14, vertikal: 1.53

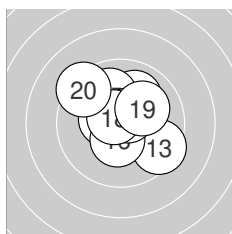

Serie 2: 101.9 (98)

10.8* ←	10.5* ←	9.5 ↘	10.0 ↗	10.0 ↑
10.4* ↓	10.6* ↗	10.7* ↘	10.1 ↗	9.3 ↘

beste Teiler: 47.0 (11.), 72.1 (18.), 85.6 (17.)
Trefferlage: 0.02 mm rechts, 0.64 mm hoch
Streuwert: 1.62, horizontal: 1.72, vertikal: 1.52

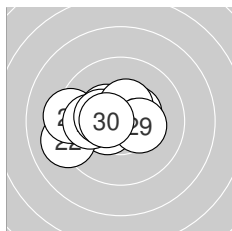

Serie 3: 101.2 (98)

10.5* ←	9.1 ←	9.3 ←	10.4* ↗	10.4* ↘
10.0 ←	10.3* ←	10.4* ↑	10.3* →	10.5* ←

beste Teiler: 116.2 (30.), 118.1 (21.), 128.4 (28.)
Trefferlage: 1.27 mm links, 0.10 mm hoch
Streuwert: 1.51, horizontal: 1.98, vertikal: 0.78

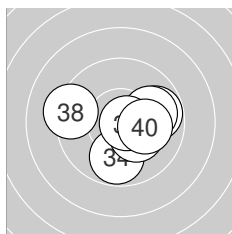

Serie 4: 101.2 (96)

10.5* ↘	10.3* ↘	10.4* ↘	9.8 ↓	10.3* ↘
9.8 →	9.9 →	9.3 ←	10.8* →	10.1 →

beste Teiler: 50.8 (39.), 110.9 (31.), 140.9 (33.)
Trefferlage: 0.83 mm rechts, 0.38 mm tief
Streuwert: 1.58, horizontal: 1.95, vertikal: 1.09



AR 40

StandNr: 133

Hechenbichler,, Clemens #70412090

Männer

Wertung

StartNr: 131

08.03.2025 13:54

SG_Kundl / SG Kundl 4

Ergebnis: **0.0** (0)_{DNS}
Serien:
Zähler: 0 0 0 0 0 0 0 0 0 0 0
Innenzehner: 0
Weiteste:
~~beste Teiler~~Schütze ist nicht zum Wettkampf angetreten
Trefferlage: 0.00 mm , 0.00 mm
Streuwert:

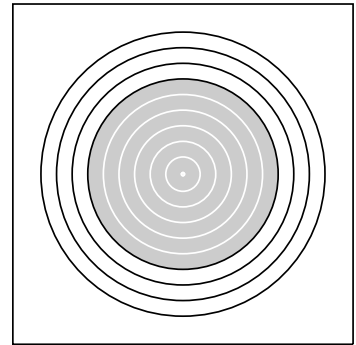

Ergebnis: 422.4 (399)
Serien: 104.7 106.6 106.0 105.1
Zähler: 39 1 0 0 0 0 0 0 0 0
Innenzehner: 39
Weiteste: 305 (3.), 200 (31.), 195 (15.)
beste Teiler: 7.6 (19.), 10.1 (36.), 29.5 (13.)
Trefferlage: 0.01 mm links, 0.14 mm hoch
Streuwert: 0.80, horizontal: 0.93, vertikal: 0.65

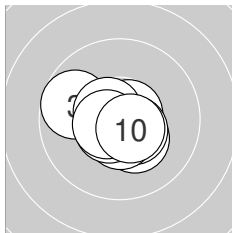
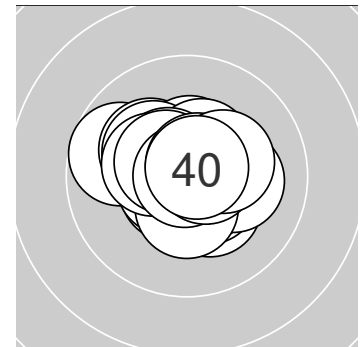

Serie 1: 104.7 (99)

10.7* ↗	10.6* ↓	9.7 ←	10.6* ↖	10.3* ↘
10.5* ↘	10.5* ↓	10.6* ↗	10.6* ←	10.6* ↘

beste Teiler: 65.8 (1.), 77.3 (2.), 89.3 (9.)
Trefferlage: 0.23 mm links, 0.34 mm tief
Streuwert: 0.97, horizontal: 1.17, vertikal: 0.71

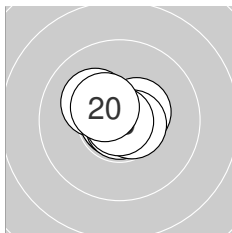

Serie 2: 106.6 (100)

10.8* ↖	10.8* ↗	10.8* ←	10.5* ↗	10.2* ↖
10.8* ←	10.8* ↓	10.6* →	10.9* ↓	10.4* ↖

beste Teiler: 7.6 (19.), 29.5 (13.), 30.0 (17.)
Trefferlage: 0.13 mm links, 0.25 mm hoch
Streuwert: 0.65, horizontal: 0.79, vertikal: 0.49

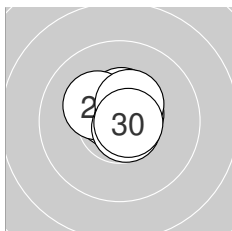

Serie 3: 106.0 (100)

10.8* ↗	10.7* ↑	10.8* →	10.6* ↖	10.5* ↑
10.2* ↖	10.6* ↗	10.4* ↗	10.7* ↘	10.7* →

beste Teiler: 41.1 (23.), 43.8 (21.), 52.0 (22.)
Trefferlage: 0.11 mm rechts, 0.45 mm hoch
Streuwert: 0.61, horizontal: 0.66, vertikal: 0.56

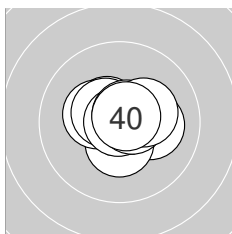

Serie 4: 105.1 (100)

10.2* →	10.4* ↓	10.5* ↖	10.3* ←	10.5* ↖
10.9* ←	10.6* →	10.7* ↗	10.3* →	10.7* ↗

beste Teiler: 10.1 (36.), 57.3 (40.), 67.2 (38.)
Trefferlage: 0.19 mm rechts, 0.20 mm hoch
Streuwert: 0.89, horizontal: 1.09, vertikal: 0.61



Ergebnis: 418.3 (399)
Serien: 103.8 105.1 105.4 104.0
Zähler: 39 1 0 0 0 0 0 0 0 0 0
Innenzehner: 38
Weiteste: 272 (2.), 202 (22.), 194 (5.)
beste Teiler: 18.9 (29.), 21.0 (13.), 34.1 (9.)
Trefferlage: 0.30 mm links, 0.18 mm hoch
Streuwert: 0.96, horizontal: 0.74, vertikal: 1.13

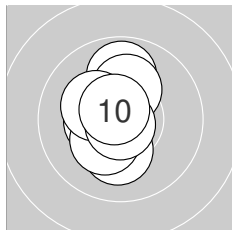
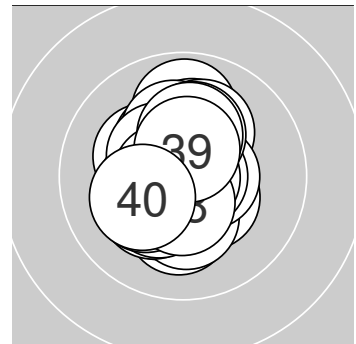

Serie 1: 103.8 (99)

10.6* ←	9.9 ↑	10.2* ↑	10.4* ←	10.2* ↓
10.5* ↙	10.3* ↙	10.2* ↘	10.8* ↓	10.7* ↘

beste Teiler: 34.1 (9.), 73.7 (10.), 77.5 (1.)
Trefferlage: 0.56 mm links, 0.13 mm hoch
Streuwert: 1.10, horizontal: 0.64, vertikal: 1.42

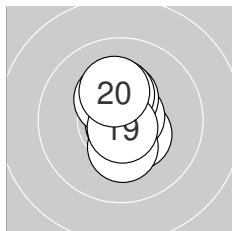

Serie 2: 105.1 (100)

10.8* ↘	10.4* ↘	10.9* ↓	10.7* →	10.4* ↑
10.3* ↑	10.3* ↓	10.3* ↘	10.8* ↓	10.2* ↑

beste Teiler: 21.0 (13.), 39.9 (11.), 49.4 (19.)
Trefferlage: 0.11 mm rechts, 0.28 mm hoch
Streuwert: 0.91, horizontal: 0.48, vertikal: 1.20

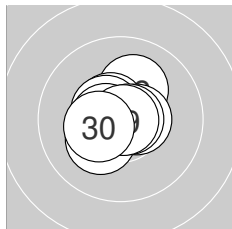

Serie 3: 105.4 (100)

10.8* →	10.1 ↑	10.6* ↘	10.5* ↘	10.2* ↙
10.6* ←	10.5* →	10.8* →	10.9* →	10.4* ←

beste Teiler: 18.9 (29.), 39.8 (21.), 50.0 (28.)
Trefferlage: 0.23 mm links, 0.14 mm hoch
Streuwert: 0.85, horizontal: 0.89, vertikal: 0.81

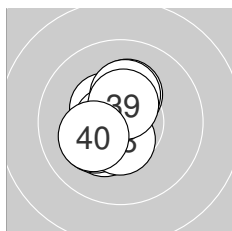

Serie 4: 104.0 (100)

10.2* ↑	10.7* ↘	10.4* ↘	10.3* ↙	10.3* ↑
10.7* ←	10.2* ↙	10.5* ↓	10.5* ↑	10.2* ↙

beste Teiler: 53.1 (32.), 74.0 (36.), 112.0 (38.)
Trefferlage: 0.54 mm links, 0.17 mm hoch
Streuwert: 1.00, horizontal: 0.78, vertikal: 1.18



AR 40

StandNr: 136

Hintner,, Patrick #70403010

Männer

Wertung

StartNr: 134

08.03.2025 13:24

SG_Brandenberg / Brandenburg 1

Ergebnis: **405.6** (386)
 Serien: 99.8 102.5 103.4 99.9
 Zähler: 26 14 0 0 0 0 0 0 0 0
 Innenzehner: 21
 Weitest: 444 (1.), 410 (33.), 383 (31.)
 beste Teiler: 2.2 (27.), 62.9 (36.), 71.3 (24.)
 Trefferlage: 0.38 mm rechts, 0.03 mm hoch
 Streuwert: 1.60, horizontal: 1.75, vertikal: 1.44

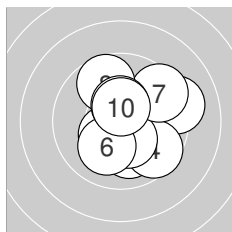
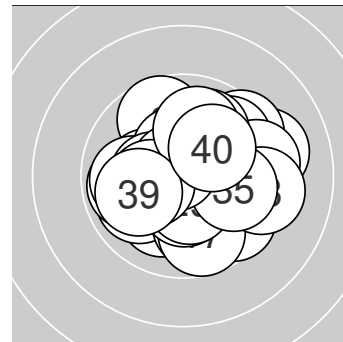
**Serie 1: 99.8 (96)**

9.2 →	10.4* ↖	10.0 ↓	9.6 ↘	10.4* ↓
10.1 ↙	9.5 ↗	9.7 ↕	10.4* ↑	10.5* ↑

beste Teiler: 111.0 (10.), 126.0 (9.), 144.2 (2.)
 Trefferlage: 0.78 mm rechts, 0.01 mm hoch
 Streuwert: 1.90, horizontal: 1.88, vertikal: 1.93

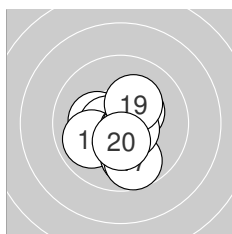
**Serie 2: 102.5 (97)**

10.2* ←	10.6* ←	10.4* ↗	9.9 ↖	10.6* ↘
9.9 ↓	9.7 ↓	10.6* ↘	10.2* ↗	10.4* ↓

beste Teiler: 82.7 (15.), 88.5 (18.), 98.9 (12.)
 Trefferlage: 0.01 mm rechts, 0.66 mm tief
 Streuwert: 1.32, horizontal: 1.24, vertikal: 1.39

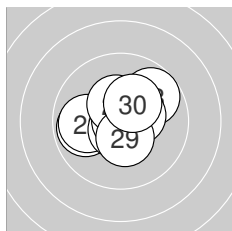
**Serie 3: 103.4 (97)**

9.9 ←	9.9 ←	9.8 ↗	10.7* ↙	10.7* ↗
10.4* →	10.9* ↗	10.4* ↑	10.4* ↓	10.3* ↗

beste Teiler: 2.2 (27.), 71.3 (24.), 75.5 (25.)
 Trefferlage: 0.06 mm links, 0.31 mm hoch
 Streuwert: 1.32, horizontal: 1.57, vertikal: 1.01

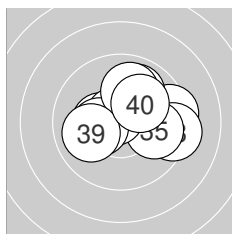
**Serie 4: 99.9 (96)**

9.4 →	9.9 ↗	9.3 →	10.3* ←	9.9 →
10.7* ↘	10.3* ←	10.0 ↑	10.0 ←	10.1 ↗

beste Teiler: 62.9 (36.), 151.0 (34.), 167.1 (37.)
 Trefferlage: 0.79 mm rechts, 0.46 mm hoch
 Streuwert: 1.80, horizontal: 2.25, vertikal: 1.20



Ergebnis: 417.9 (398)
Serien: 103.7 104.3 103.9 106.0
Zähler: 38 2 0 0 0 0 0 0 0 0 0
Innenzehner: 32
Weiteste: 323 (22.), 297 (7.), 247 (38.)
beste Teiler: 5.0 (18.), 19.4 (32.), 23.7 (35.)
Trefferlage: 0.20 mm links, 0.28 mm tief
Streuwert: 1.02, horizontal: 1.20, vertikal: 0.80

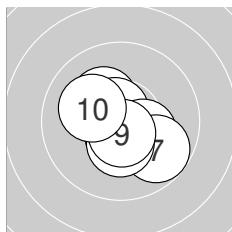
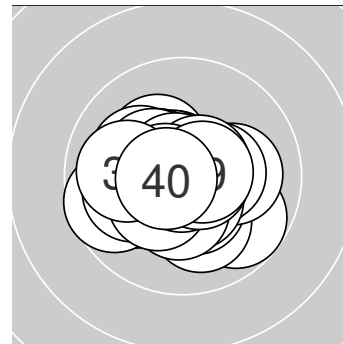

Serie 1: 103.7 (99)

10.4* ↖	10.2* ↖	10.7* ↖	10.3* →	10.6* ↓
10.6* ↓	9.8 ↘	10.4* ↓	10.6* ↓	10.1 ↖

beste Teiler: 74.7 (3.), 79.4 (9.), 90.0 (5.)
Trefferlage: 0.07 mm links, 0.32 mm tief
Streuwert: 1.18, horizontal: 1.25, vertikal: 1.10

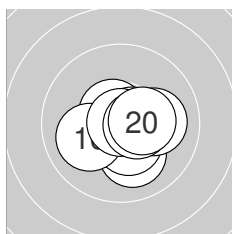

Serie 2: 104.3 (100)

10.1 ↓	10.6* ↖	10.5* ↗	10.7* →	10.4* ↓
10.1 ↖	10.1 →	10.9* ↑	10.5* →	10.4* →

beste Teiler: 5.0 (18.), 74.5 (14.), 85.4 (12.)
Trefferlage: 0.34 mm rechts, 0.38 mm tief
Streuwert: 1.03, horizontal: 1.21, vertikal: 0.81

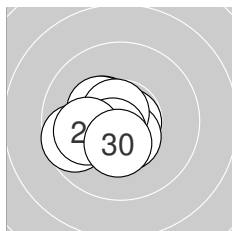

Serie 3: 103.9 (99)

10.5* ↗	9.7 ↖	10.4* ↖	10.8* →	10.3* ↖
10.5* ↓	10.7* ↖	10.6* ↗	10.0 ↖	10.4* ↓

beste Teiler: 47.6 (24.), 65.1 (27.), 88.6 (28.)
Trefferlage: 0.86 mm links, 0.37 mm tief
Streuwert: 0.97, horizontal: 1.11, vertikal: 0.81

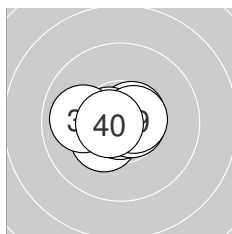

Serie 4: 106.0 (100)

10.6* ↗	10.9* →	10.7* →	10.3* ↗	10.9* ↓
10.7* →	10.6* ↖	10.0 ↖	10.6* →	10.7* ↖

beste Teiler: 19.4 (32.), 23.7 (35.), 51.2 (33.)
Trefferlage: 0.21 mm links, 0.06 mm tief
Streuwert: 0.80, horizontal: 1.06, vertikal: 0.40



Ergebnis: 414.1 (396)
Serien: 104.6 101.6 104.1 103.8
Zähler: 36 4 0 0 0 0 0 0 0 0 0
Innenzehner: 28
Weiteste: 286 (18.), 282 (39.), 273 (11.)
beste Teiler: 10.0 (3.), 28.0 (37.), 32.6 (28.)
Trefferlage: 0.17 mm links, 0.02 mm hoch
Streuwert: 1.20, horizontal: 1.33, vertikal: 1.04

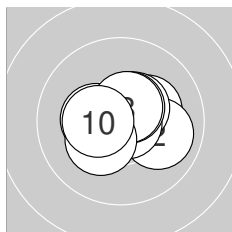
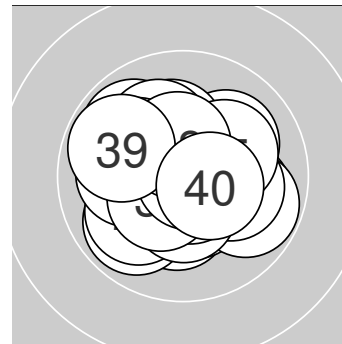

Serie 1: 104.6 (100)

10.3* →	10.0 →	10.9* ↘	10.5* ↗	10.8* →
10.3* ←	10.5* ↗	10.6* ↗	10.3* ↖	10.4* ←

beste Teiler: 10.0 (3.), 37.0 (5.), 95.3 (8.)
Trefferlage: 0.17 mm rechts, 0.13 mm hoch
Streuwert: 1.04, horizontal: 1.29, vertikal: 0.70

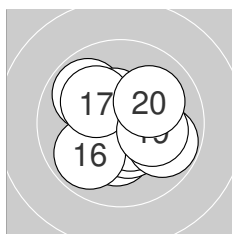

Serie 2: 101.6 (97)

9.9 ↘	10.4* ↑	10.3* ↓	10.4* ↓	10.6* ↘
9.9 ↖	10.1 ↘	9.8 →	10.1 →	10.1 ↗

beste Teiler: 98.0 (15.), 128.0 (12.), 130.1 (14.)
Trefferlage: 0.13 mm rechts, 0.14 mm tief
Streuwert: 1.55, horizontal: 1.67, vertikal: 1.42

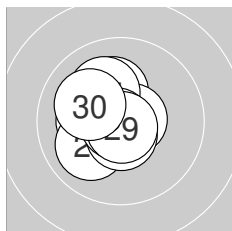

Serie 3: 104.1 (100)

10.6* ←	10.2* ↑	10.7* →	10.2* ←	10.0 ↖
10.6* ↓	10.1 ↘	10.8* ↖	10.8* ↓	10.1 ↘

beste Teiler: 32.6 (28.), 39.6 (29.), 69.0 (23.)
Trefferlage: 0.75 mm links, 0.18 mm hoch
Streuwert: 0.99, horizontal: 0.91, vertikal: 1.07

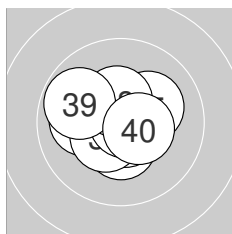

Serie 4: 103.8 (99)

10.1 ←	10.5* ↓	10.4* ↓	10.7* ↓	10.2* ↗
10.4* ↖	10.8* →	10.4* ↑	9.8 ↘	10.5* →

beste Teiler: 28.0 (37.), 66.1 (34.), 116.5 (32.)
Trefferlage: 0.26 mm links, 0.09 mm tief
Streuwert: 1.17, horizontal: 1.35, vertikal: 0.96



AR 40

StandNr: 139

Eberharter,, Stefan #70817185**Männer**

Wertung

SG_Zell_am_Ziller / SG Zell am Ziller 1

StartNr: 137

08.03.2025 13:29

Ergebnis: **414.4** (395)
 Serien: 105.0 101.6 104.2 103.6
 Zähler: 35 5 0 0 0 0 0 0 0 0
 Innenzehner: 33
 Weitester: 430 (12.), 341 (15.), 292 (13.)
 beste Teiler: 31.0 (30.), 32.6 (36.), 50.2 (26.)
 Trefferlage: 0.09 mm links, 0.40 mm hoch
 Streuwert: 1.20, horizontal: 1.15, vertikal: 1.24

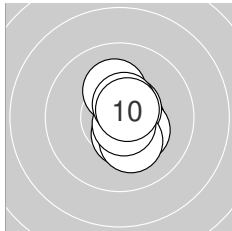
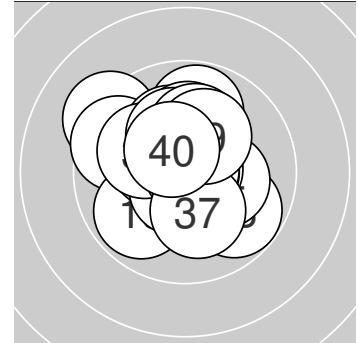
**Serie 1: 105.0 (100)**

10.2* ↑	10.6* →	10.5* ↓	10.7* →	10.3* ↘
10.6* ↗	10.2* ↓	10.7* ↘	10.6* ↑	10.6* ↗

beste Teiler: 55.7 (4.), 57.1 (8.), 77.0 (10.)
 Trefferlage: 0.53 mm rechts, 0.04 mm tief
 Streuwert: 0.82, horizontal: 0.46, vertikal: 1.07

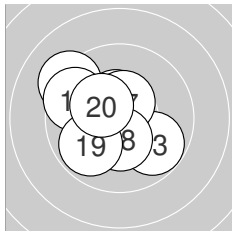
**Serie 2: 101.6 (96)**

10.5* ↑	9.2 ↘	9.8 ↘	10.8* ↘	9.6 ↘
10.6* ↓	10.5* ↑	10.4* ↓	9.9 ↗	10.3* ↘

beste Teiler: 50.9 (14.), 79.1 (16.), 114.9 (17.)
 Trefferlage: 0.80 mm links, 0.16 mm hoch
 Streuwert: 1.63, horizontal: 1.74, vertikal: 1.52

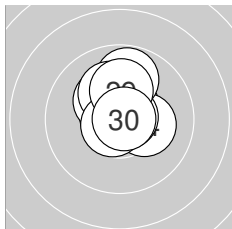
**Serie 3: 104.2 (99)**

10.7* ↖	10.3* ↖	10.6* ↗	10.2* →	9.8 ↑
10.8* →	10.2* ↑	10.7* ↗	10.1 ↑	10.8* →

beste Teiler: 31.0 (30.), 50.2 (26.), 61.6 (21.)
 Trefferlage: 0.09 mm rechts, 0.82 mm hoch
 Streuwert: 0.98, horizontal: 0.82, vertikal: 1.11

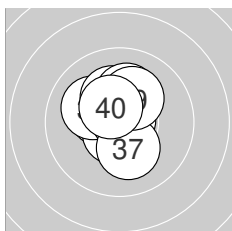
**Serie 4: 103.6 (100)**

10.4* ↖	10.6* ↘	10.4* ↑	10.1 ↖	10.2* ↑
10.8* →	10.2* ↓	10.2* ↑	10.2* ↑	10.5* ↖

beste Teiler: 32.6 (36.), 83.6 (32.), 123.6 (40.)
 Trefferlage: 0.21 mm links, 0.67 mm hoch
 Streuwert: 1.05, horizontal: 0.90, vertikal: 1.19



Ergebnis: 414.0 (396)
Serien: 105.0 103.8 104.2 101.0
Zähler: 36 4 0 0 0 0 0 0 0 0
Innenzehner: 31
Weiteste: 421 (27.), 403 (35.), 289 (39.)
beste Teiler: 41.1 (9.), 45.6 (21.), 46.8 (29.)
Trefferlage: 0.12 mm links, 0.05 mm hoch
Streuwert: 1.24, horizontal: 1.45, vertikal: 0.98

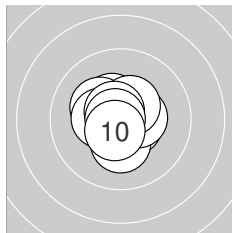
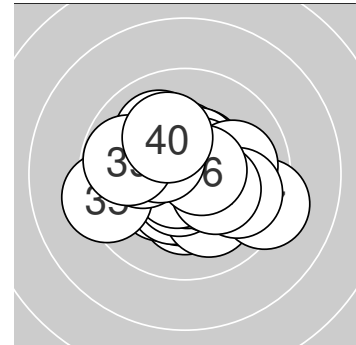

Serie 1: 105.0 (100)

10.4* ↖	10.2* ↖	10.6* ➤	10.3* ↓	10.5* ➔
10.5* ↗	10.4* ←	10.7* ↖	10.8* ←	10.6* ↙

beste Teiler: 41.1 (9.), 74.6 (8.), 94.3 (10.)
Trefferlage: 0.21 mm links, 0.08 mm hoch
Streuwert: 0.92, horizontal: 0.93, vertikal: 0.91

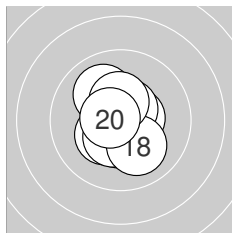

Serie 2: 103.8 (100)

10.5* ↖	10.5* ➔	10.6* ↗	10.4* ↓	10.0 ↖
10.3* ↗	10.4* ↙	10.1 ↘	10.4* ↑	10.6* ←

beste Teiler: 80.8 (20.), 97.6 (13.), 108.1 (12.)
Trefferlage: 0.20 mm links, 0.00 mm
Streuwert: 1.11, horizontal: 0.88, vertikal: 1.30

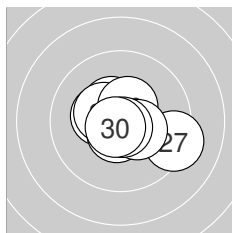

Serie 3: 104.2 (99)

10.8* ↓	10.3* ←	10.6* ↙	10.4* ↖	10.4* ↖
10.5* ↗	9.3 ➤	10.4* ➤	10.8* ↓	10.7* ↙

beste Teiler: 45.6 (21.), 46.8 (29.), 58.7 (30.)
Trefferlage: 0.18 mm rechts, 0.10 mm tief
Streuwert: 1.25, horizontal: 1.55, vertikal: 0.86

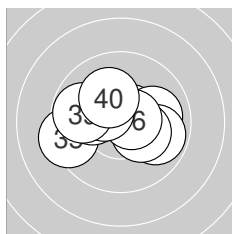

Serie 4: 101.0 (97)

10.6* ↗	10.0 ➔	9.8 ➤	10.3* ➤	9.3 ←
10.6* ➔	10.1 ←	10.4* ↖	9.8 ←	10.1 ↖

beste Teiler: 85.3 (36.), 91.2 (31.), 148.3 (38.)
Trefferlage: 0.28 mm links, 0.22 mm hoch
Streuwert: 1.70, horizontal: 2.23, vertikal: 0.92



Ergebnis: **417.7** (400)
 Serien: 104.3 103.5 104.3 105.6
 Zähler: 40 0 0 0 0 0 0 0 0 0 0
 Innenzehner: 34
 Weitester: 242 (11.), 234 (40.), 228 (30.)
 beste Teiler: 22.6 (39.), 46.2 (25.), 48.8 (5.)
 Trefferlage: 0.26 mm links, 0.02 mm hoch
 Streuwert: 0.98, horizontal: 1.06, vertikal: 0.90

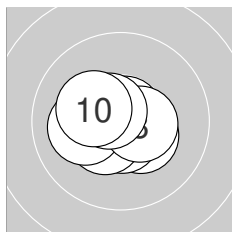
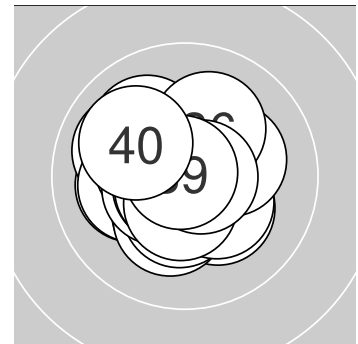

Serie 1: 104.3 (100)

10.4* ↘	10.6* ↓	10.3* ↖	10.3* ←	10.8* ↗
10.4* ↗	10.1 ←	10.5* →	10.6* ↘	10.3* ↖

beste Teiler: 48.8 (5.), 83.4 (2.), 90.6 (9.)
 Trefferlage: 0.57 mm links, 0.07 mm tief
 Streuwert: 0.96, horizontal: 1.19, vertikal: 0.64

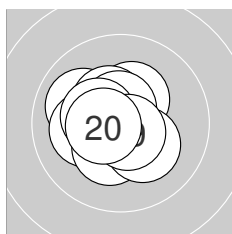

Serie 2: 103.5 (100)

10.0 ↖	10.1 ←	10.3* ↗	10.3* ↘	10.4* ↖
10.6* ↑	10.2* ↘	10.4* ↖	10.7* ↘	10.5* ←

beste Teiler: 68.4 (19.), 85.8 (16.), 103.4 (20.)
 Trefferlage: 0.56 mm links, 0.10 mm hoch
 Streuwert: 1.07, horizontal: 1.14, vertikal: 1.01

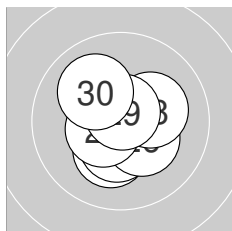

Serie 3: 104.3 (100)

10.5* ↘	10.2* ↓	10.7* ↘	10.4* ↓	10.8* →
10.3* ↘	10.5* ↖	10.2* →	10.7* ↑	10.0 ↖

beste Teiler: 46.2 (25.), 54.9 (29.), 74.0 (23.)
 Trefferlage: 0.18 mm rechts, 0.25 mm tief
 Streuwert: 1.02, horizontal: 1.03, vertikal: 1.02

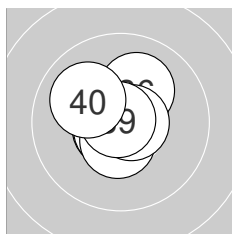

Serie 4: 105.6 (100)

10.7* ↖	10.7* ↑	10.7* ↑	10.7* ↖	10.6* ↗
10.1 ↗	10.5* ↓	10.7* →	10.9* ↖	10.0 ↖

beste Teiler: 22.6 (39.), 63.0 (38.), 66.9 (32.)
 Trefferlage: 0.12 mm links, 0.34 mm hoch
 Streuwert: 0.85, horizontal: 0.81, vertikal: 0.89



Ergebnis: **415.6** (397)
 Serien: 103.8 104.6 103.9 103.3
 Zähler: 37 3 0 0 0 0 0 0 0 0
 Innenzehner: 34
 Weitesten: 311 (17.), 281 (3.), 279 (25.)
 beste Teiler: 55.4 (12.), 56.9 (39.), 60.2 (35.)
 Trefferlage: 0.48 mm links, 0.32 mm tief
 Streuwert: 1.01, horizontal: 1.08, vertikal: 0.94

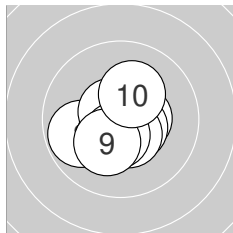
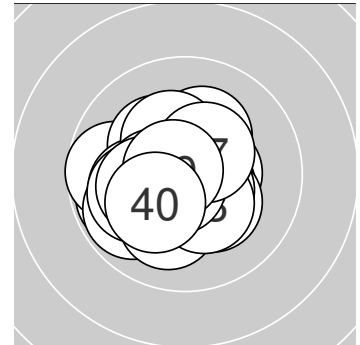

Serie 1: 103.8 (99)

10.5* →	10.6* ↘	9.8 ←	10.5* ↘	10.4* ✓
10.6* ↖	10.5* ↘	10.5* ↓	10.2* ✓	10.2* ↗

beste Teiler: 79.5 (6.), 80.9 (2.), 106.3 (4.)
 Trefferlage: 0.13 mm links, 0.48 mm tief
 Streuwert: 1.07, horizontal: 1.15, vertikal: 0.98

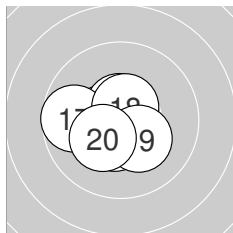

Serie 2: 104.6 (99)

10.7* ↑	10.7* ✓	10.5* ↓	10.5* ←	10.7* ✓
10.6* ↑	9.7 ←	10.6* ↑	10.3* ↘	10.3* ✓

beste Teiler: 55.4 (12.), 69.2 (15.), 74.6 (11.)
 Trefferlage: 0.52 mm links, 0.16 mm tief
 Streuwert: 1.01, horizontal: 1.14, vertikal: 0.85

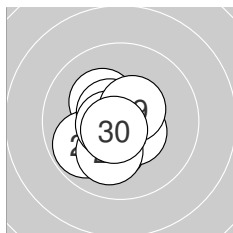

Serie 3: 103.9 (99)

10.7* →	10.2* ↓	10.2* ↖	10.5* ↘	9.8 ✓
10.6* ↖	10.1 ↓	10.6* ←	10.5* ↗	10.7* ✓

beste Teiler: 64.8 (21.), 72.8 (30.), 80.7 (28.)
 Trefferlage: 0.44 mm links, 0.38 mm tief
 Streuwert: 1.06, horizontal: 0.98, vertikal: 1.13

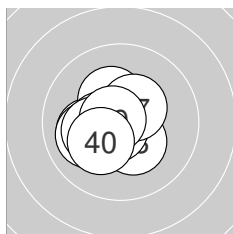

Serie 4: 103.3 (100)

10.1 ←	10.3* ↖	10.3* ↘	10.0 ←	10.7* ✓
10.4* ←	10.4* ↗	10.2* ←	10.7* ←	10.2* ✓

beste Teiler: 56.9 (39.), 60.2 (35.), 130.2 (37.)
 Trefferlage: 0.84 mm links, 0.26 mm tief
 Streuwert: 1.00, horizontal: 1.08, vertikal: 0.91



Ergebnis: **415.8** (397)
 Serien: 103.7 103.3 105.2 103.6
 Zähler: 37 3 0 0 0 0 0 0 0 0 0
 Innenzehner: 34
 Weitestе: 413 (37.), 329 (34.), 282 (16.)
 beste Teiler: 2.0 (26.), 12.0 (40.), 25.0 (33.)
 Trefferlage: 0.14 mm links, 0.00 mm
 Streuwert: 1.15, horizontal: 1.36, vertikal: 0.87

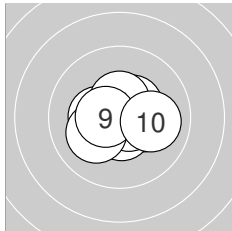
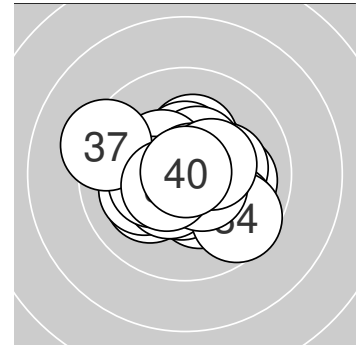

Serie 1: 103.7 (100)

10.4* ↗	10.3* →	10.3* ←	10.6* ↓	10.7* →
10.3* ←	10.5* ↑	10.1 ↗	10.5* ←	10.0 →

beste Teiler: 73.1 (5.), 97.1 (4.), 103.0 (9.)
 Trefferlage: 0.00 mm , 0.13 mm tief
 Streuwert: 1.13, horizontal: 1.42, vertikal: 0.72

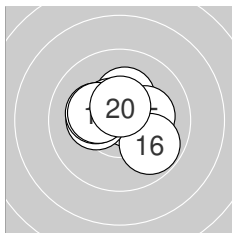

Serie 2: 103.3 (99)

10.5* ↘	10.3* ↑	10.5* ↘	10.7* →	10.2* →
9.8 ↘	10.3* ←	10.2* ←	10.3* ←	10.5* ↑

beste Teiler: 71.8 (14.), 101.1 (20.), 106.4 (13.)
 Trefferlage: 0.15 mm links, 0.41 mm hoch
 Streuwert: 1.20, horizontal: 1.45, vertikal: 0.89

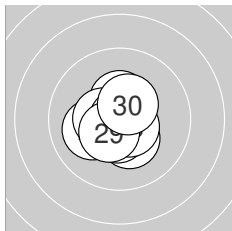

Serie 3: 105.2 (100)

10.8* →	10.1 ←	10.3* ↓	10.4* ↑	10.5* ←
10.9* ↓	10.6* ↓	10.6* ↘	10.5* ↗	10.5* ↗

beste Teiler: 2.0 (26.), 43.9 (21.), 88.2 (28.)
 Trefferlage: 0.16 mm links, 0.20 mm tief
 Streuwert: 0.90, horizontal: 0.91, vertikal: 0.90

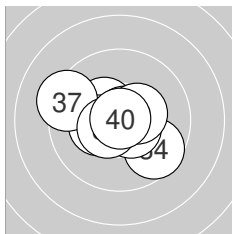

Serie 4: 103.6 (98)

10.4* ↘	10.3* ←	10.9* ↓	9.6 ↘	10.8* ↗
10.5* ↘	9.3 ↘	10.5* ↗	10.4* →	10.9* ↑

beste Teiler: 12.0 (40.), 25.0 (33.), 44.4 (35.)
 Trefferlage: 0.23 mm links, 0.06 mm tief
 Streuwert: 1.42, horizontal: 1.76, vertikal: 0.97



AR 40

StandNr: 144

Fuchs,, Manfred jun. #70406038**Männer**

Wertung

StartNr: 142

08.03.2025 13:25

SG_Bruckhäusl

Ergebnis: **416.7** (399)
 Serien: 104.2 105.2 103.4 103.9
 Zähler: 39 1 0 0 0 0 0 0 0 0
 Innenzehner: 37
 Weitestе: 261 (38.), 224 (36.), 203 (9.)
 beste Teiler: 11.0 (18.), 34.1 (20.), 47.7 (39.)
 Trefferlage: 0.30 mm links, 0.10 mm tief
 Streuwert: 1.01, horizontal: 0.94, vertikal: 1.07

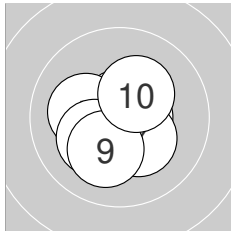
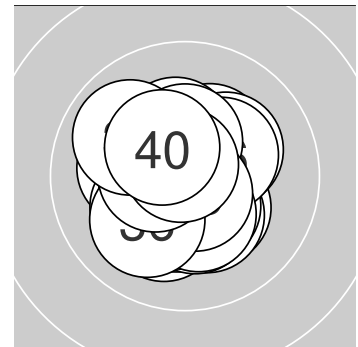
**Serie 1: 104.2 (100)**

10.6* ←	10.6* ↙	10.7* ↑	10.6* ↓	10.2* ←
10.6* →	10.3* ↘	10.2* ↗	10.1 ↙	10.3* ↗

beste Teiler: 56.0 (3.), 85.8 (4.), 87.0 (1.)
 Trefferlage: 0.23 mm links, 0.36 mm tief
 Streuwert: 1.02, horizontal: 1.07, vertikal: 0.98

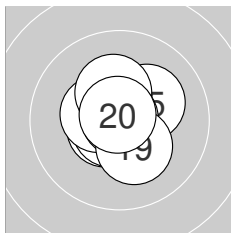
**Serie 2: 105.2 (100)**

10.5* ↑	10.6* ↙	10.5* ↗	10.7* ↙	10.2* ↗
10.4* ←	10.3* ↑	10.9* ↑	10.3* ↓	10.8* ↑

beste Teiler: 11.0 (18.), 34.1 (20.), 71.4 (14.)
 Trefferlage: 0.00 mm, 0.29 mm hoch
 Streuwert: 0.90, horizontal: 0.86, vertikal: 0.93

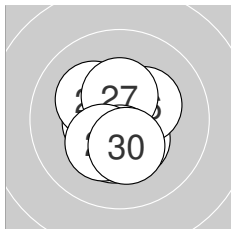
**Serie 3: 103.4 (100)**

10.4* ↓	10.5* ←	10.3* ↘	10.3* ↓	10.2* ↘
10.3* ↗	10.4* ↑	10.4* ↓	10.3* ↙	10.3* ↓

beste Teiler: 113.1 (22.), 135.0 (27.), 136.0 (21.)
 Trefferlage: 0.26 mm links, 0.29 mm tief
 Streuwert: 1.10, horizontal: 0.95, vertikal: 1.24

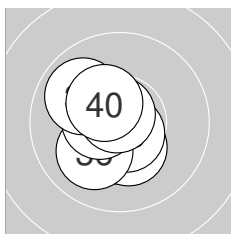
**Serie 4: 103.9 (99)**

10.4* ↓	10.6* ↘	10.3* ↓	10.3* ↘	10.6* ↓
10.1 ↙	10.5* ←	9.9 ↘	10.8* ↑	10.4* ↘

beste Teiler: 47.7 (39.), 78.3 (35.), 97.2 (32.)
 Trefferlage: 0.72 mm links, 0.07 mm tief
 Streuwert: 1.03, horizontal: 0.87, vertikal: 1.16



Ergebnis: 418.4 (399)
Serien: 105.3 105.5 103.5 104.1
Zähler: 39 1 0 0 0 0 0 0 0 0 0
Innenzehner: 35
Weiteste: 255 (22.), 243 (8.), 240 (1.)
beste Teiler: 7.0 (17.), 30.5 (9.), 48.0 (5.)
Trefferlage: 0.01 mm links, 0.07 mm hoch
Streuwert: 0.96, horizontal: 0.85, vertikal: 1.06

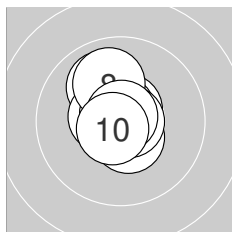
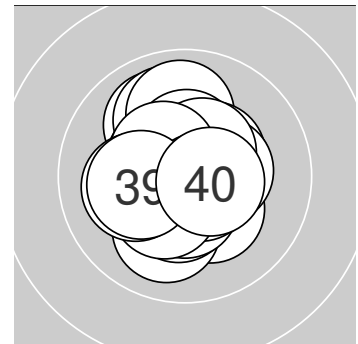

Serie 1: 105.3 (100)

10.0 ↘	10.6* ↗	10.7* ↑	10.5* ↘	10.8* →
10.5* ←	10.7* ↘	10.0 ↑	10.8* ↑	10.7* ↗

beste Teiler: 30.5 (9.), 48.0 (5.), 58.3 (7.)
Trefferlage: 0.23 mm links, 0.54 mm hoch
Streuwert: 0.84, horizontal: 0.60, vertikal: 1.03

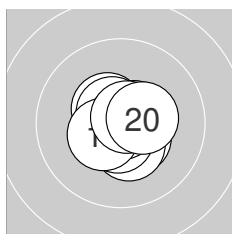

Serie 2: 105.5 (100)

10.5* ↘	10.4* ↘	10.4* ↘	10.6* ↘	10.6* ↓
10.6* ↗	10.9* →	10.4* ↗	10.7* ↗	10.4* →

beste Teiler: 7.0 (17.), 53.7 (19.), 82.4 (14.)
Trefferlage: 0.14 mm rechts, 0.11 mm tief
Streuwert: 0.78, horizontal: 0.79, vertikal: 0.77

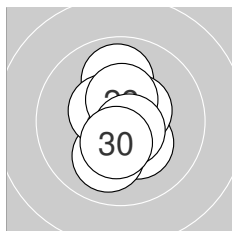

Serie 3: 103.5 (99)

10.4* ↘	9.9 ↑	10.5* ↑	10.3* ↘	10.0 ↓
10.5* ↘	10.5* ↗	10.4* ↑	10.6* ↘	10.4* ↓

beste Teiler: 76.4 (29.), 101.0 (23.), 116.2 (27.)
Trefferlage: 0.10 mm rechts, 0.04 mm tief
Streuwert: 1.17, horizontal: 0.70, vertikal: 1.50

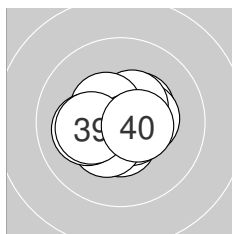

Serie 4: 104.1 (100)

10.4* ↗	10.4* →	10.5* ↗	10.5* ↘	10.5* ↓
10.6* ↘	10.4* ↗	10.1 ←	10.2* ←	10.5* →

beste Teiler: 77.4 (36.), 107.4 (40.), 115.0 (35.)
Trefferlage: 0.07 mm links, 0.09 mm tief
Streuwert: 1.05, horizontal: 1.26, vertikal: 0.80



AR 40

StandNr: 146

Egger,, Hannes #70401069

Männer

Wertung

StartNr: 144

08.03.2025 13:29

SG_Angerberg / SG Angerberg 1

Ergebnis: **419.0** (399)
 Serien: 105.1 105.6 103.5 104.8
 Zähler: 39 1 0 0 0 0 0 0 0 0
 Innenzehner: 35
 Weitestе: 264 (24.), 235 (21.), 224 (15.)
 beste Teiler: 2.8 (29.), 22.8 (11.), 23.3 (17.)
 Trefferlage: 0.06 mm rechts, 0.18 mm tief
 Streuwert: 0.98, horizontal: 1.02, vertikal: 0.94

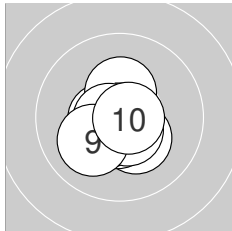
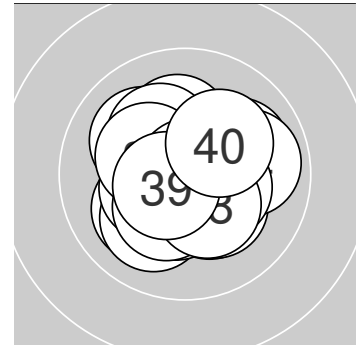
**Serie 1: 105.1 (100)**

10.3* ↘	10.6* ←	10.6* ↓	10.7* ↙	10.3* ↑
10.5* ↗	10.7* ←	10.6* ↘	10.1 ↗	10.7* →

beste Teiler: 56.3 (10.), 69.2 (7.), 71.5 (4.)
 Trefferlage: 0.24 mm links, 0.47 mm tief
 Streuwert: 0.83, horizontal: 0.81, vertikal: 0.86

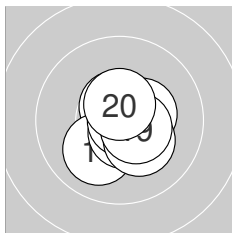
**Serie 2: 105.6 (100)**

10.9* ↘	10.6* ↑	10.8* ↘	10.4* →	10.1 ↗
10.6* ↓	10.9* →	10.2* ↘	10.5* ↘	10.6* ↑

beste Teiler: 22.8 (11.), 23.3 (17.), 45.2 (13.)
 Trefferlage: 0.30 mm rechts, 0.25 mm tief
 Streuwert: 0.84, horizontal: 0.78, vertikal: 0.88

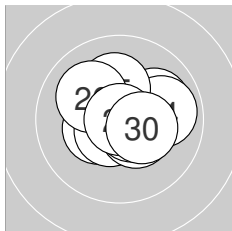
**Serie 3: 103.5 (99)**

10.0 →	10.4* ←	10.6* ↗	9.9 →	10.2* ↑
10.1 ↖	10.4* ↘	10.6* ↘	10.9* ↘	10.4* →

beste Teiler: 2.8 (29.), 86.4 (28.), 93.7 (23.)
 Trefferlage: 0.39 mm rechts, 0.16 mm hoch
 Streuwert: 1.23, horizontal: 1.44, vertikal: 0.97

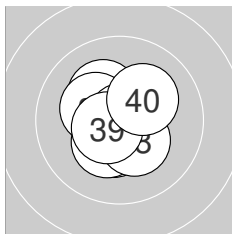
**Serie 4: 104.8 (100)**

10.2* ↘	10.8* ↓	10.4* ↓	10.3* ↖	10.9* →
10.3* ↗	10.8* ↓	10.3* ↘	10.6* ↗	10.2* ↗

beste Teiler: 23.7 (35.), 33.1 (32.), 50.0 (37.)
 Trefferlage: 0.20 mm links, 0.15 mm tief
 Streuwert: 0.98, horizontal: 0.90, vertikal: 1.06



AR 40

StandNr: 147

Fuchs,, Tobias #70313124**Männer**

Wertung

StartNr: 145

08.03.2025 13:20

SG_Westendorf

Ergebnis: **407.3** (388)
 Serien: 102.7 99.7 102.4 102.5
 Zähler: 28 12 0 0 0 0 0 0 0 0
 Innenzehner: 25
 Weitestе: 404 (34.), 400 (11.), 390 (1.)
 beste Teiler: 35.3 (8.), 36.3 (33.), 67.4 (23.)
 Trefferlage: 0.07 mm rechts, 0.05 mm hoch
 Streuwert: 1.57, horizontal: 1.67, vertikal: 1.47

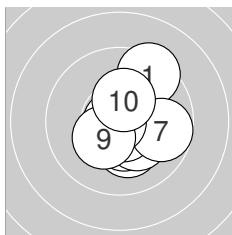
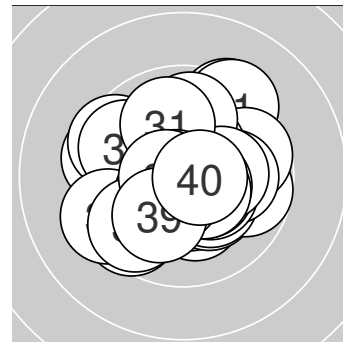
**Serie 1: 102.7 (98)**

9.4 ↗	10.2* ↓	10.4* ↓	10.7* ↗	10.2* ↘
10.7* ↓	9.7 →	10.8* ←	10.3* ↙	10.3* ↑

beste Teiler: 35.3 (8.), 70.2 (6.), 71.6 (4.)
 Trefferlage: 0.67 mm rechts, 0.13 mm tief
 Streuwert: 1.38, horizontal: 1.16, vertikal: 1.56

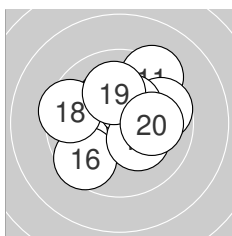
**Serie 2: 99.7 (96)**

9.4 ↗	10.3* ↖	9.7 →	10.4* →	10.4* ↗
9.6 ↙	10.3* ↘	9.5 ←	10.1 ↑	10.0 →

beste Teiler: 132.0 (14.), 144.9 (15.), 171.4 (12.)
 Trefferlage: 0.36 mm rechts, 0.62 mm hoch
 Streuwert: 1.91, horizontal: 2.14, vertikal: 1.64

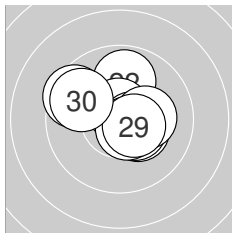
**Serie 3: 102.4 (97)**

10.3* ↘	9.9 ↑	10.7* ↑	9.5 ↖	10.4* ↘
10.6* →	10.2* →	10.6* ↓	10.5* →	9.7 ↖

beste Teiler: 67.4 (23.), 84.6 (28.), 96.4 (26.)
 Trefferlage: 0.10 mm rechts, 0.35 mm hoch
 Streuwert: 1.47, horizontal: 1.70, vertikal: 1.18

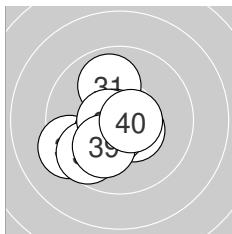
**Serie 4: 102.5 (97)**

9.9 ↑	10.5* ↘	10.8* ←	9.3 ↙	10.4* ↙
9.7 ↙	10.6* ↙	10.6* ←	10.1 ↙	10.6* →

beste Teiler: 36.3 (33.), 80.1 (38.), 80.3 (40.)
 Trefferlage: 0.85 mm links, 0.62 mm tief
 Streuwert: 1.34, horizontal: 1.33, vertikal: 1.35



Ergebnis: **411.4** (397)
 Serien: 103.4 103.3 102.5 102.2
 Zähler: 37 3 0 0 0 0 0 0 0 0
 Innenzehner: 27
 Weitester: 391 (15.), 260 (39.), 254 (8.)
 beste Teiler: 16.1 (18.), 43.2 (5.), 61.8 (34.)
 Trefferlage: 0.22 mm links, 0.00 mm
 Streuwert: 1.30, horizontal: 1.50, vertikal: 1.07

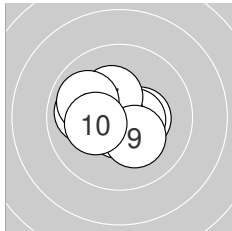
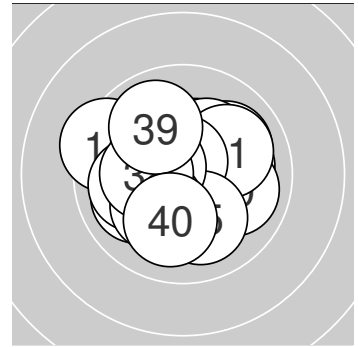

Serie 1: 103.4 (99)

10.7* ↓	10.0 ←	10.4* →	10.5* →	10.8* ←
10.4* ←	10.3* ↑	9.9 ↖	10.2* ↘	10.2* ←

beste Teiler: 43.2 (5.), 72.0 (1.), 108.6 (4.)
 Trefferlage: 0.52 mm links, 0.04 mm hoch
 Streuwert: 1.16, horizontal: 1.42, vertikal: 0.84

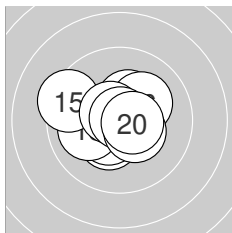

Serie 2: 103.3 (99)

10.3* ↙	10.5* ↘	10.0 ←	10.4* ↑	9.4 ←
10.2* ↗	10.6* ↖	10.9* ↑	10.4* ↘	10.6* →

beste Teiler: 16.1 (18.), 85.1 (17.), 93.7 (20.)
 Trefferlage: 0.38 mm links, 0.07 mm hoch
 Streuwert: 1.35, horizontal: 1.61, vertikal: 1.02

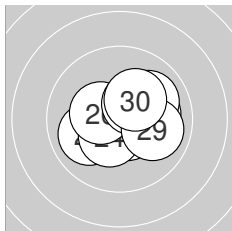

Serie 3: 102.5 (100)

10.0 ←	10.6* ↘	10.1 →	10.4* ↙	10.4* ↗
10.4* ←	10.4* ↗	10.0 ↗	10.0 →	10.2* ↗

beste Teiler: 92.6 (22.), 135.9 (25.), 139.0 (24.)
 Trefferlage: 0.61 mm rechts, 0.15 mm hoch
 Streuwert: 1.30, horizontal: 1.55, vertikal: 1.00

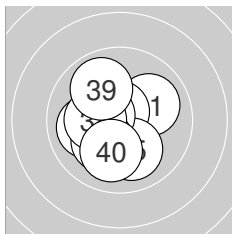

Serie 4: 102.2 (99)

10.0 ↗	10.0 ←	10.5* ↙	10.7* ↑	10.1 ↓
10.5* ←	10.2* ↘	10.3* ←	9.9 ↖	10.0 ↓

beste Teiler: 61.8 (34.), 117.6 (33.), 118.9 (36.)
 Trefferlage: 0.60 mm links, 0.30 mm tief
 Streuwert: 1.37, horizontal: 1.29, vertikal: 1.44

