

Ergebnis: **191.2** (181)
 Serien: 96.1 95.1
 Zähler: 7 8 4 1 0 0 0 0 0 0
 Innenzehner: 6
 Weitester: 877 (15.), 615 (12.), 596 (7.)
 beste Teiler: 61.8 (5.), 100.5 (17.), 126.8 (8.)
 Trefferkreis: 18.84 mm
 Trefferlage: 1.06 mm rechts, 0.16 mm hoch

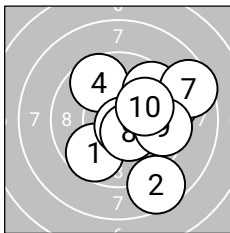
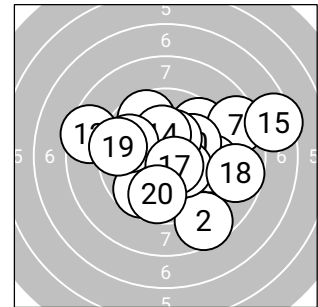

Serie 1: 96.1 (91)

9.7 ↙	8.6 ↘	9.3 →	9.7 ↖	10.7* ↘
9.6 ↗	8.6 →	10.4* ↘	9.5 →	10.0 →

beste Teiler: 61.8 (5.), 126.8 (8.), 228.9 (10.)
 Trefferkreis: 13.89 mm
 Trefferlage: 1.83 mm rechts, 0.02 mm hoch

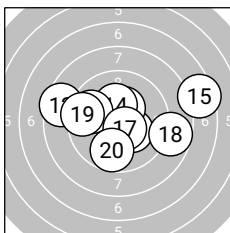

Serie 2: 95.1 (90)

10.3* ↘	8.5 ←	10.4* ↗	10.3* ↑	7.4 →
9.8 ←	10.6* ↘	8.7 →	9.4 ←	9.7 ↓

beste Teiler: 100.5 (17.), 146.3 (13.), 168.4 (11.)
 Trefferkreis: 18.83 mm
 Trefferlage: 0.29 mm rechts, 0.30 mm hoch



Ergebnis: **192.3** (184)
 Serien: 96.2 96.1
 Zähler: 7 10 3 0 0 0 0 0 0 0 0
 Innenzehner: 5
 Weitester: 733 (14.), 650 (4.), 542 (8.)
 beste Teiler: 113.5 (12.), 119.4 (7.), 122.0 (17.)
 Trefferkreis: 17.49 mm
 Trefferlage: 0.21 mm links, 0.00 mm

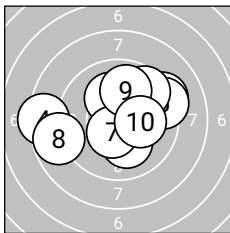
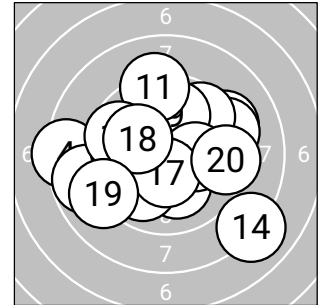

Serie 1: 96.2 (92)

10.1 ↘	9.2 ↗	10.2* ↖	8.4 ←	9.3 →
9.6 ↗	10.5* ↘	8.8 ←	9.9 ↑	10.2* →

beste Teiler: 119.4 (7.), 192.8 (10.), 199.6 (3.)
 Trefferkreis: 14.99 mm
 Trefferlage: 0.03 mm rechts, 0.52 mm hoch

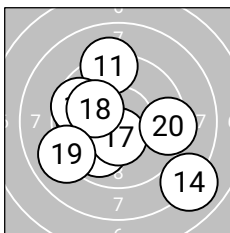

Serie 2: 96.1 (92)

9.2 ↑	10.5* ↘	9.9 ↘	8.0 ↘	9.9 ←
9.6 ←	10.5* ↓	10.1 ←	9.0 ←	9.4 →

beste Teiler: 113.5 (12.), 122.0 (17.), 208.0 (18.)
 Trefferkreis: 15.86 mm
 Trefferlage: 0.47 mm links, 0.52 mm tief



Ergebnis: **195.6 (185)**
 Serien: 96.6 99.0
 Zähler: 7 11 2 0 0 0 0 0 0 0 0
 Innenzehner: 5
 Weitester: 603 (2.), 535 (10.), 466 (7.)
 beste Teiler: 52.6 (1.), 97.2 (3.), 129.8 (13.)
 Trefferkreis: 15.24 mm
 Trefferlage: 0.23 mm links, 0.32 mm tief

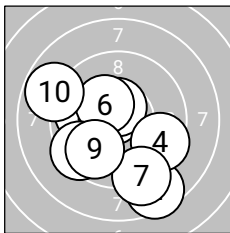
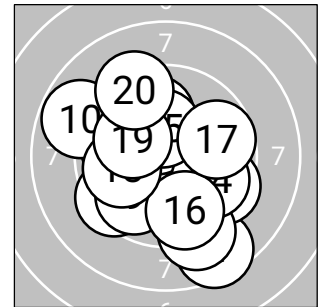

Serie 1: 96.6 (91)

10.7*↖	8.5↘	10.6*↑	9.5↘	9.9↖
10.3*↖	9.1↘	9.4↖	9.8↖	8.8↖

beste Teiler: 52.6 (1.), 97.2 (3.), 157.2 (6.)
 Trefferkreis: 15.24 mm
 Trefferlage: 0.60 mm links, 1.09 mm tief

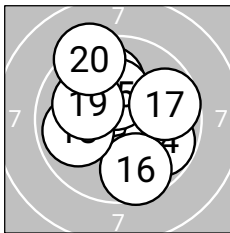

Serie 2: 99.0 (94)

10.0↑	9.9↘	10.4*↖	9.8↘	10.3*↑
9.6↘	9.7↗	9.9↖	10.1↖	9.3↖

beste Teiler: 129.8 (13.), 160.2 (15.), 214.2 (19.)
 Trefferkreis: 12.00 mm
 Trefferlage: 0.14 mm rechts, 0.44 mm hoch



Ergebnis: **197.4** (186)
 Serien: 96.5 100.9
 Zähler: 8 10 2 0 0 0 0 0 0 0
 Innenzehner: 6
 Weitester: 618 (2.), 551 (6.), 450 (9.)
 beste Teiler: 37.1 (10.), 66.0 (20.), 142.8 (19.)
 Trefferkreis: 13.89 mm
 Trefferlage: 0.72 mm rechts, 0.77 mm hoch

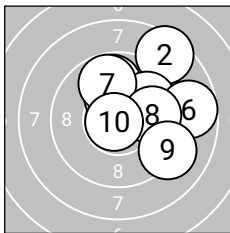
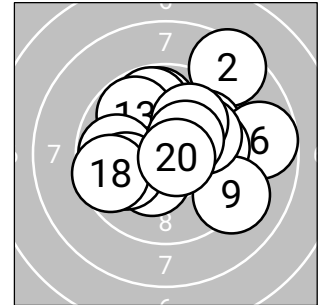

Serie 1: 96.5 (90)

9.6→	8.5↗	9.8↑	10.3*↑	9.9↗
8.7→	9.8↑	9.9→	9.2↘	10.8*↖

beste Teiler: 37.1 (10.), 174.4 (4.), 266.3 (8.)
 Trefferkreis: 12.19 mm
 Trefferlage: 1.91 mm rechts, 1.21 mm hoch

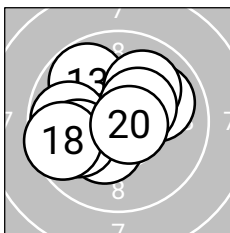

Serie 2: 100.9 (96)

10.4*↗	10.0↗	9.8↘	10.3*↘	9.8←
9.9↖	10.0↗	9.6←	10.4*↗	10.7*→

beste Teiler: 66.0 (20.), 142.8 (19.), 143.1 (11.)
 Trefferkreis: 10.34 mm
 Trefferlage: 0.45 mm links, 0.33 mm hoch



Ergebnis: **407.8** (386)
 Serien: 102.1 97.8 104.7 103.2
 Zähler: 27 12 1 0 0 0 0 0 0 0
 Innenzehner: 25
 Weitester: 672 (20.), 406 (11.), 358 (36.)
 beste Teiler: 4.4 (31.), 27.0 (25.), 37.0 (39.)
 Trefferkreis: 14.51 mm
 Trefferlage: 0.16 mm rechts, 0.11 mm tief

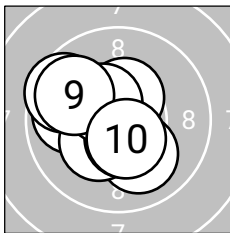
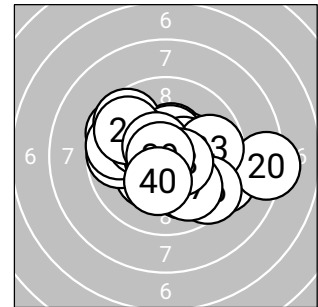

Serie 1: 102.1 (97)

9.9 ←	10.6* ↑	10.1 ↓	10.4* ↑	10.3* ↓
10.5* ↓	9.6 ←	10.4* ↖	9.8 ↖	10.5* ↓

beste Teiler: 87.0 (2.), 110.0 (6.), 117.0 (10.)
 Trefferkreis: 9.96 mm
 Trefferlage: 0.79 mm links, 0.10 mm hoch

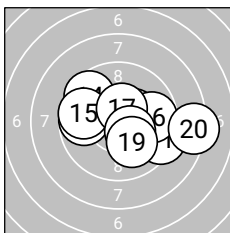

Serie 2: 97.8 (93)

9.3 →	10.4* →	9.7 ←	9.6 ↖	9.7 ←
9.8 →	10.5* ↑	10.4* →	10.1 ↓	8.3 →

beste Teiler: 117.1 (17.), 136.2 (18.), 148.0 (12.)
 Trefferkreis: 14.35 mm
 Trefferlage: 0.86 mm rechts, 0.02 mm hoch

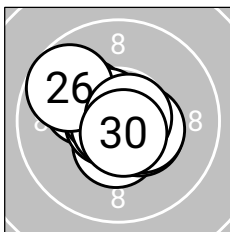

Serie 3: 104.7 (99)

10.5* ↓	10.2* ↖	10.7* ←	10.6* ↖	10.8* ↖
9.7 ↖	10.4* →	10.4* →	10.7* →	10.7* ↓

beste Teiler: 27.0 (25.), 52.4 (23.), 55.0 (29.)
 Trefferkreis: 8.80 mm
 Trefferlage: 0.26 mm links, 0.02 mm hoch

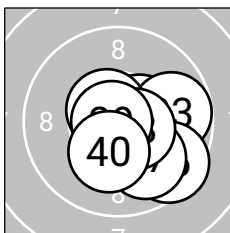

Serie 4: 103.2 (97)

10.9* ↑	10.5* →	9.8 →	10.3* ↓	10.6* ↖
9.5 ↓	9.9 ↓	10.6* →	10.8* ←	10.3* ↓

beste Teiler: 4.4 (31.), 37.0 (39.), 91.9 (35.)
 Trefferkreis: 9.00 mm
 Trefferlage: 0.86 mm rechts, 0.62 mm tief



Ergebnis: **399.2 (382)**
Serien: 99.7 100.0 98.6 100.9
Zähler: 23 16 1 0 0 0 0 0 0 0
Innenzehner: 15
Weiteste: 506 (21.), 429 (22.), 383 (26.)
beste Teiler: 91.7 (29.), 108.7 (32.), 116.2 (8.)
Trefferkreis: 13.08 mm
Trefferlage: 0.42 mm rechts, 0.18 mm hoch

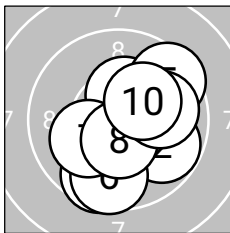
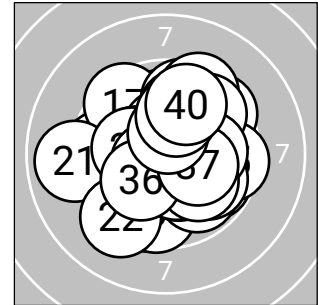

Serie 1: 99.7 (95)

10.1➔ 9.8↘ 10.4*↑ 9.6↘ 9.5↗
 9.6↘ 10.1↙ 10.5*↓ 9.9➔ 10.2*↗

beste Teiler: 116.2 (8.), 146.0 (3.), 178.4 (10.)
Trefferkreis: 11.19 mm
Trefferlage: 0.83 mm rechts, 0.43 mm tief

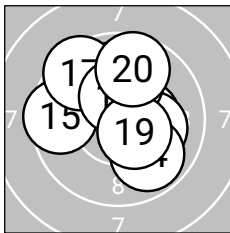

Serie 2: 100.0 (96)

10.4*➔ 10.1➔ 10.0↑ 9.9↘ 9.5↙
 10.0↑ 9.5↖ 10.4*↑ 10.5*↘ 9.7↑

beste Teiler: 123.4 (19.), 137.7 (18.), 148.5 (11.)
Trefferkreis: 10.86 mm
Trefferlage: 0.14 mm rechts, 0.88 mm hoch

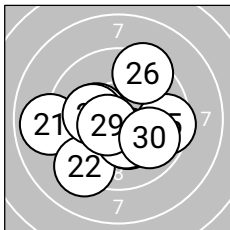

Serie 3: 98.6 (94)

8.9↙ 9.2↘ 10.3*↘ 10.3*↘ 9.5➔
 9.4↗ 10.3*↙ 10.2*↙ 10.6*↙ 9.9↘

beste Teiler: 91.7 (29.), 152.8 (24.), 162.3 (23.)
Trefferkreis: 13.08 mm
Trefferlage: 0.29 mm links, 0.48 mm tief

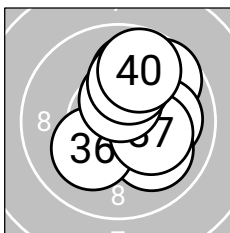

Serie 4: 100.9 (97)

9.7↗ 10.5*↗ 10.0➔ 9.9↑ 10.0↘
 10.2*↙ 10.2*↘ 10.5*↑ 10.1↑ 9.8↑

beste Teiler: 108.7 (32.), 116.7 (38.), 188.1 (37.)
Trefferkreis: 9.65 mm
Trefferlage: 1.03 mm rechts, 0.77 mm hoch



Ergebnis: **375.0 (357)**
Serien: 89.6 94.8 97.7 92.9
Zähler: 8 23 8 0 1 0 0 0 0 0 0
Innenzehner: 7
Weiteste: 1048 (10.), 695 (31.), 690 (4.)
beste Teiler: 25.6 (26.), 72.0 (30.), 82.5 (14.)
Trefferkreis: 21.15 mm
Trefferlage: 1.07 mm rechts, 0.24 mm hoch

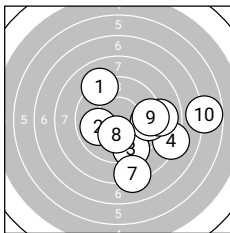
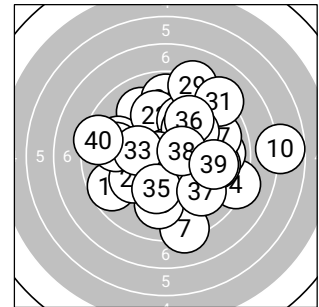

Serie 1: 89.6 (85)

9.1 ↖ 9.9 ↙ 9.4 ↘ 8.2 → 9.5 →
 8.9 → 8.2 ↘ 10.2* ↓ 9.4 → 6.8 →

beste Teiler: 180.4 (8.), 257.1 (2.), 370.1 (5.)
Trefferkreis: 18.43 mm
Trefferlage: 2.79 mm rechts, 1.04 mm tief

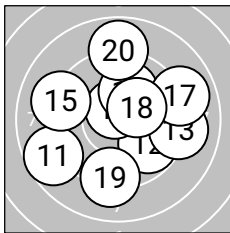

Serie 2: 94.8 (91)

8.7 ↙ 9.8 ↘ 9.1 → 10.6* ↖ 9.1 ↙
 10.1 ↗ 9.0 → 10.3* ↗ 9.2 ↓ 8.9 ↗

beste Teiler: 82.5 (14.), 165.8 (18.), 225.8 (16.)
Trefferkreis: 15.13 mm
Trefferlage: 0.34 mm rechts, 0.24 mm hoch

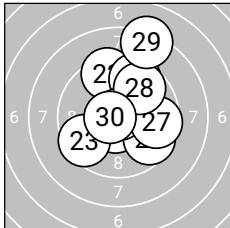

Serie 3: 97.7 (92)

10.6* ↓ 9.4 ↖ 9.5 ↙ 9.6 ↘ 9.5 ↗
 10.9* ↗ 9.6 → 9.7 ↗ 8.2 ↗ 10.7* ↖

beste Teiler: 25.6 (26.), 72.0 (30.), 90.2 (21.)
Trefferkreis: 14.56 mm
Trefferlage: 0.69 mm rechts, 1.08 mm hoch

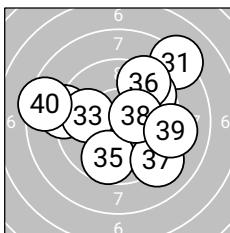

Serie 4: 92.9 (89)

8.2 ↗ 9.1 ↙ 9.9 ↙ 9.6 ↗ 9.7 ↓
 9.4 ↗ 9.1 ↘ 10.3* → 9.2 → 8.4 ↖

beste Teiler: 153.0 (38.), 259.8 (33.), 311.8 (35.)
Trefferkreis: 16.50 mm
Trefferlage: 0.46 mm rechts, 0.67 mm hoch



LG 40 ZR

StandNr: 120

Kathrein,, Elisabeth #70209028

Senioren_2w

Wertung

StartNr: 20

31.01.2026 13:22

SG_Hötting-lbk

Ergebnis: **373.7 (358)**
 Serien: 84.9 97.2 96.5 95.1
 Zähler: 16 15 7 1 0 0 0 0 0 0 1
 Innenzehner: 11
 Weitester: 797 (37.), 710 (17.), 676 (2.)
 beste Teiler: 53.2 (25.), 82.0 (19.), 108.9 (9.)
 Trefferkreis: 19.06 mm
 Trefferlage: 0.45 mm links, 1.06 mm tief

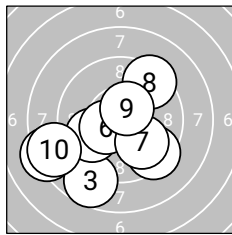
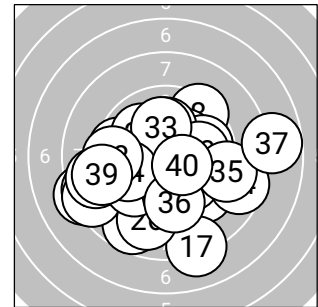
**Serie 1: 84.9 (80)**

9.4 ↘	8.2 ↙	8.7 ↘	0.0F _{MIS}	9.9 ↙
10.4* ↙	9.9 ↘	9.4 ↗	10.5* ↗	8.5 ↙

beste Teiler: 108.9 (9.), 133.2 (6.), 258.8 (7.)
 Trefferkreis: 14.98 mm
 Trefferlage: 1.12 mm links, 1.43 mm tief

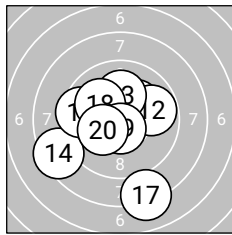
**Serie 2: 97.2 (94)**

10.2* ↗	9.8 →	10.1 ↑	8.4 ↙	10.3* ↙
9.5 ↙	8.1 ↘	10.0 ↙	10.6* ↓	10.2* ↙

beste Teiler: 82.0 (19.), 173.3 (15.), 181.6 (20.)
 Trefferkreis: 14.32 mm
 Trefferlage: 0.75 mm links, 0.51 mm tief

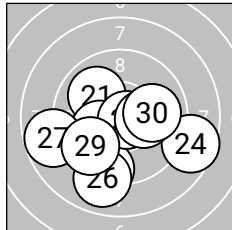
**Serie 3: 96.5 (93)**

10.0 ↙	10.2* ↙	9.3 ↓	8.6 →	10.7* ↘
9.0 ↓	8.8 ↙	10.2* →	9.7 ↙	10.0 →

beste Teiler: 53.2 (25.), 182.7 (28.), 187.1 (22.)
 Trefferkreis: 15.20 mm
 Trefferlage: 0.33 mm links, 1.41 mm tief

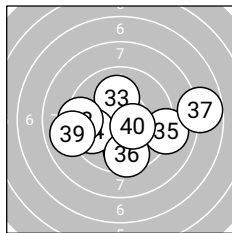
**Serie 4: 95.1 (91)**

10.3* ↓	9.8 ↓	10.1 ↑	9.7 ↙	9.1 →
9.5 ↓	7.8 →	9.4 ↙	9.0 ↙	10.4* →

beste Teiler: 139.1 (40.), 151.7 (31.), 217.6 (33.)
 Trefferkreis: 17.40 mm
 Trefferlage: 0.31 mm rechts, 0.91 mm tief

Fußnoten-Legende:

MIS - Treffer wurde manuell eingefügt, da der Schütze die Scheibe verfehlt hat



Ergebnis: 396.2 (378)
Serien: 100.1 97.7 99.1 99.3
Zähler: 19 20 1 0 0 0 0 0 0 0
Innenzehner: 15
Weiteste: 614 (25.), 460 (35.), 458 (33.)
beste Teiler: 29.9 (40.), 63.6 (21.), 79.1 (11.)
Trefferkreis: 14.91 mm
Trefferlage: 0.74 mm links, 0.17 mm hoch

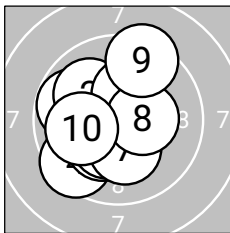
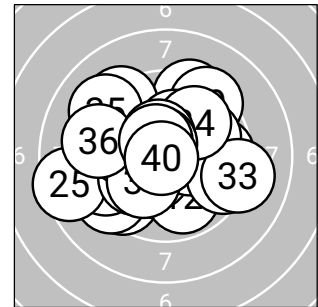

Serie 1: 100.1 (97)

9.8↙	10.0↖	10.3*↗	9.5↘	10.2*↘
10.3*↘	10.2*↘	10.4*→	9.4↗	10.0↙

beste Teiler: 150.1 (8.), 155.1 (6.), 168.6 (3.)
Trefferkreis: 11.95 mm
Trefferlage: 0.71 mm links, 0.00 mm

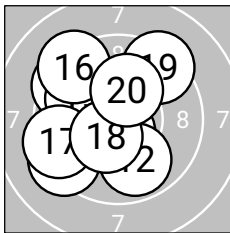

Serie 2: 97.7 (93)

10.6*↓	9.9↓	9.3↘	9.4↖	9.9↖
9.3↖	9.4↖	10.4*↘	9.3↗	10.2*↗

beste Teiler: 79.1 (11.), 129.8 (18.), 188.3 (20.)
Trefferkreis: 12.65 mm
Trefferlage: 1.18 mm links, 0.34 mm hoch

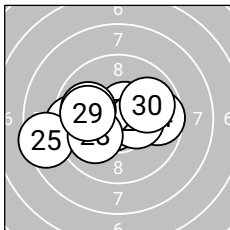

Serie 3: 99.1 (93)

10.7*↖	10.6*↗	9.5↖	9.7→	8.5↖
10.4*→	9.9↖	10.0↖	9.9↖	9.9→

beste Teiler: 63.6 (21.), 94.5 (22.), 148.8 (26.)
Trefferkreis: 13.77 mm
Trefferlage: 0.94 mm links, 0.07 mm tief

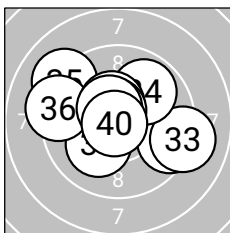

Serie 4: 99.3 (95)

10.1↘	9.5↗	9.1↗	9.9↗	9.1↖
9.3↖	10.4*↖	10.6*↖	10.5*↖	10.8*↖

beste Teiler: 29.9 (40.), 82.8 (38.), 110.3 (39.)
Trefferkreis: 13.53 mm
Trefferlage: 0.11 mm links, 0.44 mm hoch



Ergebnis: 605.2 (579)
Serien: 100.8 100.9 99.8 101.0 101.2 101.5
Zähler: 41 17 2 0 0 0 0 0 0 0
Innenzehner: 30
Weiteste: 506 (56.), 501 (22.), 484 (5.)
beste Teiler: 53.6 (7.), 57.8 (46.), 61.9 (54.)
Trefferkreis: 13.32 mm
Trefferlage: 0.70 mm links, 0.22 mm tief

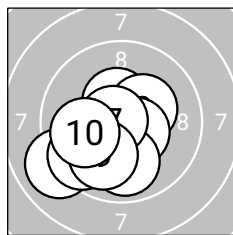
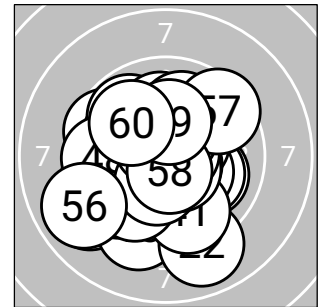

Serie 1: 100.8 (97)

10.4*↑	10.3*↗	10.4*↖	10.5*↘	9.0↙
9.9↓	10.7*↖	9.6↖	10.0↖	10.0↖

beste Teiler: 53.6 (7.), 110.8 (4.), 128.5 (1.)
Trefferkreis: 10.97 mm
Trefferlage: 0.94 mm links, 0.98 mm tief

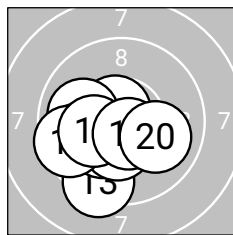

Serie 2: 100.9 (97)

10.7*↖	9.9↙	9.3↓	10.2*↖	10.4*↓
10.0↖	9.6↖	10.2*↖	10.6*↘	10.0↘

beste Teiler: 74.9 (11.), 90.0 (19.), 148.9 (15.)
Trefferkreis: 9.91 mm
Trefferlage: 1.02 mm links, 1.06 mm tief

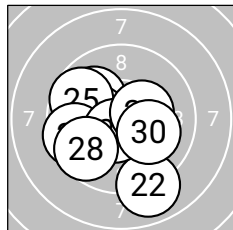

Serie 3: 99.8 (95)

10.6*↖	8.9↓	10.0↖	10.3*↖	9.7↖
9.6↖	10.6*↖	9.7↖	10.3*↗	10.1↘

beste Teiler: 88.4 (21.), 93.4 (27.), 152.4 (29.)
Trefferkreis: 12.14 mm
Trefferlage: 0.82 mm links, 0.63 mm tief

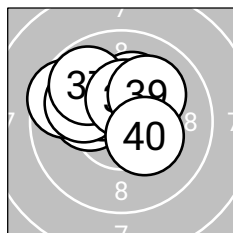

Serie 4: 101.0 (98)

10.1↖	10.2*↖	9.6↖	10.2*↑	10.3*↖
10.0↖	9.8↖	10.4*↑	10.1↗	10.3*↘

beste Teiler: 133.3 (38.), 157.6 (40.), 159.2 (35.)
Trefferkreis: 9.51 mm
Trefferlage: 0.82 mm links, 1.13 mm hoch

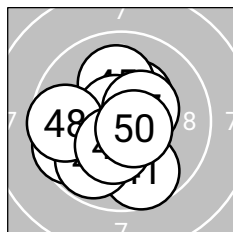

Serie 5: 101.2 (96)

9.7↓	9.6↖	9.8↖	10.3*↑	10.1↑
10.7*↖	10.4*↗	9.6↖	10.4*↓	10.6*↘

beste Teiler: 57.8 (46.), 85.2 (50.), 133.4 (47.)
Trefferkreis: 10.15 mm
Trefferlage: 0.52 mm links, 0.38 mm tief

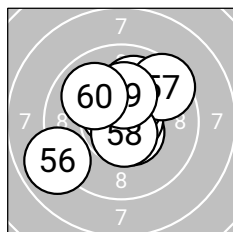

Serie 6: 101.5 (96)

10.6*↖	10.0↑	10.6*↘	10.7*↗	10.5*↑
8.9↖	9.5↗	10.6*↓	10.2*↑	9.9↖

beste Teiler: 61.9 (54.), 81.4 (58.), 83.6 (51.)
Trefferkreis: 13.16 mm
Trefferlage: 0.09 mm links, 0.60 mm hoch



Ergebnis: **622.3** (596)
 Serien: 103.1 104.5 102.4 103.3 104.3 104.7
 Zähler: 56 4 0 0 0 0 0 0 0 0
 Innenzehner: 44
 Weitestе: 335 (22.), 275 (33.), 257 (14.)
 beste Teiler: 18.3 (56.), 20.3 (17.), 35.3 (57.)
 Trefferkreis: 10.40 mm
 Trefferlage: 0.01 mm links, 0.32 mm hoch

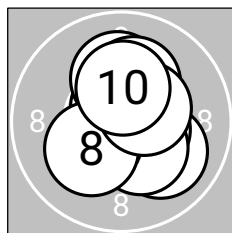
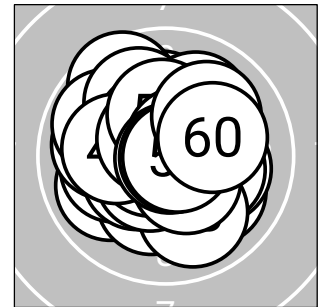

Serie 1: 103.1 (100)

10.4*↑ 10.7*↑ 10.1↑ 10.0↘ 10.5*↘
 10.2*↑ 10.3*↘ 10.2*↘ 10.4*↘ 10.3*↑

beste Teiler: 70.3 (2.), 111.3 (5.), 127.2 (9.)
 Trefferkreis: 8.74 mm
 Trefferlage: 0.41 mm rechts, 0.39 mm hoch

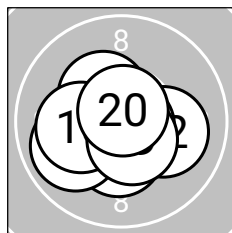

Serie 2: 104.5 (99)

10.3*↖ 10.1→ 10.4*↓ 9.9↖ 10.8*↘
 10.8*← 10.9*↓ 10.1← 10.5*↘ 10.7*↑

beste Teiler: 20.3 (17.), 38.0 (16.), 45.7 (15.)
 Trefferkreis: 8.91 mm
 Trefferlage: 0.26 mm links, 0.31 mm tief

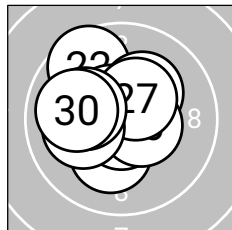

Serie 3: 102.4 (99)

10.2*↓ 9.6↖ 10.7*↓ 10.2*↗ 10.6*↖
 10.5*↘ 10.4*↗ 10.1← 10.1← 10.0←

beste Teiler: 52.0 (23.), 90.4 (25.), 114.4 (26.)
 Trefferkreis: 9.28 mm
 Trefferlage: 0.64 mm links, 0.39 mm hoch

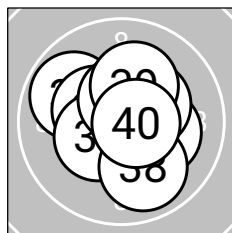

Serie 4: 103.3 (98)

10.2*↘ 10.3*↗ 9.9↖ 10.4*↖ 10.8*↖
 10.4*↖ 10.5*↑ 9.9↘ 10.2*↑ 10.7*↘

beste Teiler: 48.8 (35.), 75.5 (40.), 113.0 (37.)
 Trefferkreis: 9.56 mm
 Trefferlage: 0.03 mm rechts, 0.17 mm hoch

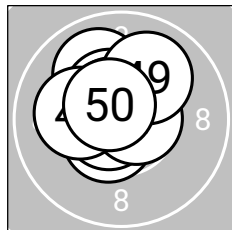

Serie 5: 104.3 (100)

10.7*↑ 10.5*↖ 10.0↖ 10.7*↖ 10.4*↖
 10.6*↖ 10.7*→ 10.1← 10.0↗ 10.6*↖

beste Teiler: 55.5 (41.), 64.8 (44.), 74.1 (47.)
 Trefferkreis: 8.20 mm
 Trefferlage: 0.41 mm links, 0.67 mm hoch

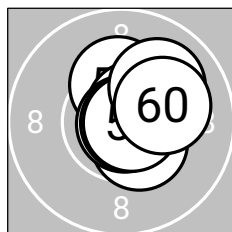

Serie 6: 104.7 (100)

10.3*↗ 10.4*↗ 10.5*↘ 10.3*↑ 10.6*↗
 10.9*↘ 10.8*→ 10.8*→ 10.0↗ 10.1→

beste Teiler: 18.3 (56.), 35.3 (57.), 48.2 (58.)
 Trefferkreis: 7.43 mm
 Trefferlage: 0.77 mm rechts, 0.59 mm hoch



Ergebnis: **626.2 (596)**
 Serien: 102.7 102.4 105.6 105.3 104.6 105.6
 Zähler: 56 4 0 0 0 0 0 0 0 0
 Innenzehner: 49
 Weitester: 338 (1.), 288 (47.), 275 (44.)
 beste Teiler: 10.0 (9.), 13.6 (55.), 13.9 (49.)
 Trefferkreis: 9.99 mm
 Trefferlage: 0.12 mm rechts, 0.32 mm hoch

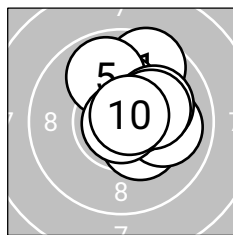
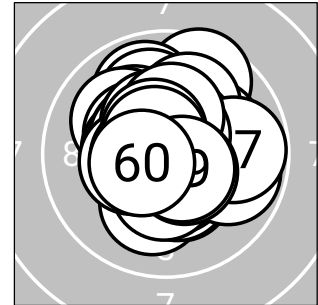

Serie 1: 102.7 (98)

9.6 ↗	10.3* ↑	10.4* ↘	10.0 →	9.9 ↖
10.6* ↗	10.1 ↗	10.2* ↗	10.9* ↓	10.7* ↗

beste Teiler: 10.0 (9.), 59.0 (10.), 82.3 (6.)
 Trefferkreis: 8.83 mm
 Trefferlage: 0.87 mm rechts, 0.81 mm hoch

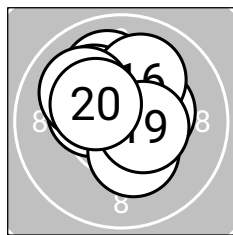

Serie 2: 102.4 (100)

10.3* ↗	10.4* ↗	10.0 ↖	10.4* ↖	10.1 ↖
10.1 ↗	10.3* ↘	10.0 ↖	10.5* →	10.3* ↖

beste Teiler: 111.5 (19.), 146.7 (12.), 149.0 (14.)
 Trefferkreis: 8.45 mm
 Trefferlage: 0.15 mm links, 0.87 mm hoch

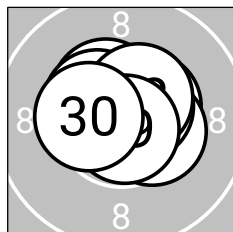

Serie 3: 105.6 (100)

10.4* ↖	10.5* ↗	10.8* ↖	10.4* →	10.7* ↖
10.6* ↗	10.5* ↖	10.5* ↗	10.8* ↘	10.4* ↖

beste Teiler: 37.1 (29.), 49.4 (23.), 57.2 (25.)
 Trefferkreis: 7.20 mm
 Trefferlage: 0.02 mm rechts, 0.42 mm hoch

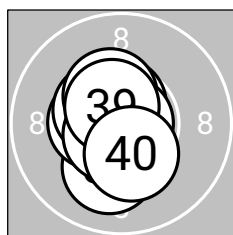

Serie 4: 105.3 (100)

10.1 ↘	10.8* ↓	10.4* ←	10.6* ↑	10.5* ↖
10.4* ↖	10.9* →	10.7* ↖	10.6* ↖	10.3* ↘

beste Teiler: 23.0 (37.), 37.0 (32.), 74.9 (38.)
 Trefferkreis: 7.86 mm
 Trefferlage: 0.37 mm links, 0.06 mm tief

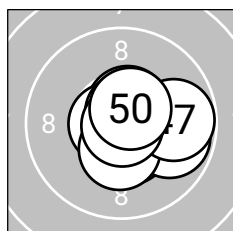

Serie 5: 104.6 (98)

10.5* ↘	10.6* ↗	10.5* ↘	9.9 →	10.7* ←
10.4* ↓	9.8 →	10.7* ↗	10.9* ↘	10.6* ↗

beste Teiler: 13.9 (49.), 63.5 (48.), 66.0 (45.)
 Trefferkreis: 8.07 mm
 Trefferlage: 0.70 mm rechts, 0.18 mm tief

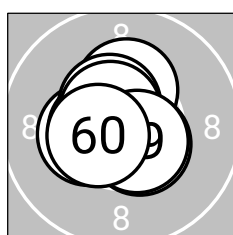

Serie 6: 105.6 (100)

10.3* ↑	10.4* ←	10.6* ←	10.5* ↘	10.9* ↘
10.7* ↖	10.5* ↖	10.6* ↖	10.6* ↘	10.5* ↖

beste Teiler: 13.6 (55.), 61.4 (56.), 79.2 (58.)
 Trefferkreis: 7.31 mm
 Trefferlage: 0.33 mm links, 0.06 mm hoch

