

LG 40 ZR

StandNr: 130

Rudig,, Kathrin #70515156

Frauen

Wertung

StartNr: 74

31.01.2026 15:16

SG_Zams

Ergebnis: **416.6** (399)
 Serien: 103.7 106.2 103.8 102.9
 Zähler: 39 1 0 0 0 0 0 0 0 0
 Innenzehner: 34
 Weitestе: 295 (5.), 240 (25.), 239 (39.)
 beste Teiler: 10.7 (26.), 15.0 (19.), 35.0 (4.)
 Trefferkreis: 9.62 mm
 Trefferlage: 0.00 mm , 0.10 mm hoch

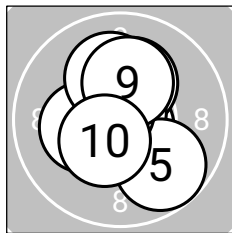
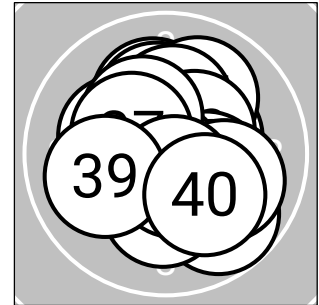
**Serie 1: 103.7** (99)

10.7*↘	10.6*↖	10.2*↑	10.8*↑	9.8↘
10.7*↖	10.2*↖	10.1↑	10.2*↑	10.4*↖

beste Teiler: 35.0 (4.), 53.0 (1.), 72.6 (6.)
 Trefferkreis: 9.41 mm
 Trefferlage: 0.11 mm links, 0.28 mm hoch

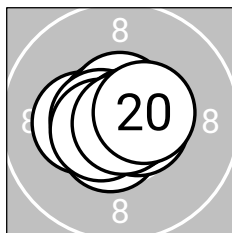
**Serie 2: 106.2** (100)

10.6*↙	10.6*→	10.3*←	10.7*↖	10.6*↑
10.6*←	10.8*→	10.6*↖	10.9*↘	10.5*→

beste Teiler: 15.0 (19.), 45.3 (17.), 63.6 (14.)
 Trefferkreis: 7.24 mm
 Trefferlage: 0.19 mm links, 0.02 mm hoch

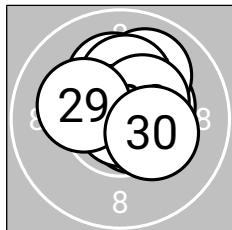
**Serie 3: 103.8** (100)

10.6*↖	10.2*↑	10.4*↗	10.6*↘	10.0↗
10.9*↘	10.2*↑	10.4*↗	10.2*↖	10.3*↘

beste Teiler: 10.7 (26.), 77.8 (24.), 89.6 (21.)
 Trefferkreis: 8.23 mm
 Trefferlage: 0.33 mm rechts, 0.73 mm hoch

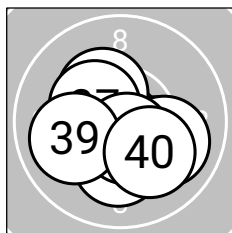
**Serie 4: 102.9** (100)

10.2*↘	10.3*↖	10.2*↓	10.8*↓	10.0↘
10.3*↖	10.4*↖	10.6*↘	10.0←	10.1↘

beste Teiler: 36.4 (34.), 89.8 (38.), 148.5 (37.)
 Trefferkreis: 8.95 mm
 Trefferlage: 0.03 mm links, 0.62 mm tief

Ergebnis: 422.3 (400)
Serien: 105.1 106.1 105.7 105.4
Zähler: 40 0 0 0 0 0 0 0 0 0 0
Innenzehner: 39
Weiteste: 237 (2.), 175 (39.), 162 (8.)
beste Teiler: 4.1 (27.), 27.2 (35.), 36.1 (15.)
Trefferkreis: 8.62 mm
Trefferlage: 0.24 mm rechts, 0.12 mm hoch

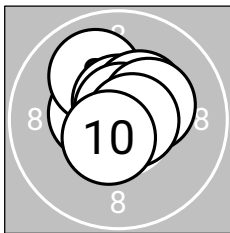
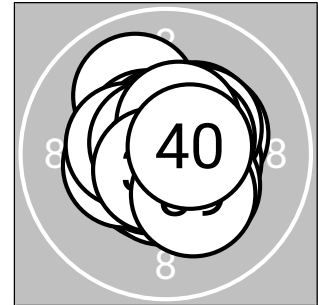

Serie 1: 105.1 (100)

10.5*←	10.0↖	10.6*↑	10.4*↗	10.8*→
10.4*↗	10.8*↑	10.3*↗	10.7*→	10.6*↘

beste Teiler: 48.0 (5.), 49.7 (7.), 67.0 (9.)
Trefferkreis: 7.77 mm
Trefferlage: 0.21 mm rechts, 0.57 mm hoch

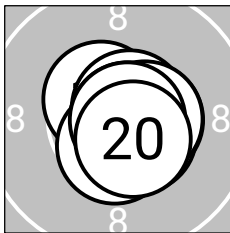

Serie 2: 106.1 (100)

10.6*↖	10.5*→	10.5*↖	10.7*↗	10.8*→
10.6*↘	10.5*↓	10.5*→	10.8*→	10.6*↘

beste Teiler: 36.1 (15.), 36.1 (19.), 62.2 (14.)
Trefferkreis: 6.58 mm
Trefferlage: 0.33 mm rechts, 0.06 mm tief

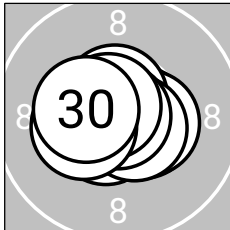

Serie 3: 105.7 (100)

10.6*→	10.5*↘	10.5*→	10.6*↘	10.6*↑
10.6*↘	10.9*↑	10.7*↖	10.3*←	10.4*←

beste Teiler: 4.1 (27.), 62.2 (28.), 82.3 (24.)
Trefferkreis: 7.19 mm
Trefferlage: 0.01 mm links, 0.05 mm tief

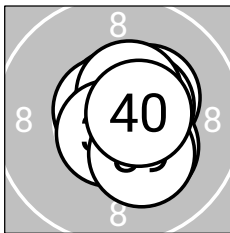

Serie 4: 105.4 (100)

10.3*↗	10.7*↑	10.7*↖	10.5*↗	10.8*↓
10.5*↗	10.3*↘	10.7*↘	10.3*↘	10.6*→

beste Teiler: 27.2 (35.), 66.2 (33.), 69.3 (38.)
Trefferkreis: 7.10 mm
Trefferlage: 0.46 mm rechts, 0.06 mm hoch



Ergebnis: 419.4 (399)
Serien: 104.8 103.9 105.9 104.8
Zähler: 39 1 0 0 0 0 0 0 0 0
Innenzehner: 38
Weiteste: 290 (12.), 242 (8.), 195 (20.)
beste Teiler: 6.0 (21.), 37.1 (27.), 43.4 (2.)
Trefferkreis: 9.07 mm
Trefferlage: 0.08 mm rechts, 0.27 mm tief

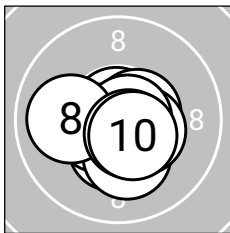
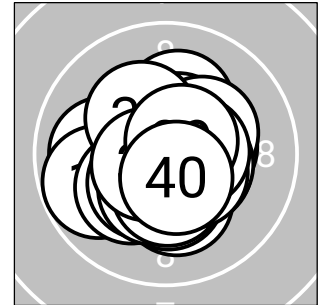

Serie 1: 104.8 (100)

10.4*↓	10.8*↑	10.6*→	10.5*↖	10.2*↓
10.4*↘	10.8*→	10.0←	10.6*↘	10.5*↘

beste Teiler: 43.4 (2.), 48.0 (7.), 88.2 (9.)
Trefferkreis: 8.16 mm
Trefferlage: 0.05 mm rechts, 0.48 mm tief

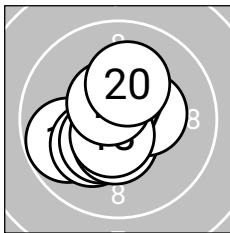

Serie 2: 103.9 (99)

10.6*↗	9.8↖	10.2*↖	10.4*↖	10.6*↓
10.5*↓	10.4*→	10.6*↘	10.6*↖	10.2*↑

beste Teiler: 80.2 (11.), 89.3 (18.), 91.0 (15.)
Trefferkreis: 8.95 mm
Trefferlage: 0.33 mm links, 0.30 mm tief

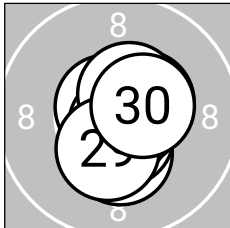

Serie 3: 105.9 (100)

10.9*↓	10.3*↓	10.6*↓	10.5*↗	10.7*→
10.7*↖	10.8*↓	10.5*↗	10.4*↘	10.5*↗

beste Teiler: 6.0 (21.), 37.1 (27.), 57.0 (25.)
Trefferkreis: 7.09 mm
Trefferlage: 0.25 mm rechts, 0.14 mm tief

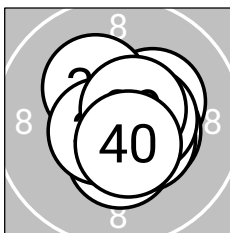

Serie 4: 104.8 (100)

10.7*↖	10.3*↗	10.4*↘	10.4*↓	10.5*↘
10.3*↖	10.5*→	10.6*↖	10.6*↗	10.5*↘

beste Teiler: 68.8 (31.), 81.6 (39.), 83.7 (38.)
Trefferkreis: 7.69 mm
Trefferlage: 0.38 mm rechts, 0.15 mm tief

LG 40 ZR

StandNr: 133

Müller,, Hannah #70423026

Frauen

Wertung

StartNr: 77

31.01.2026 15:16

SG_Walchsee

Ergebnis: **417.2 (399)**
 Serien: 104.3 103.1 105.1 104.7
 Zähler: 39 1 0 0 0 0 0 0 0 0
 Innenzehner: 38
 Weitester: 266 (13.), 205 (23.), 196 (12.)
 beste Teiler: 11.6 (36.), 66.6 (5.), 68.6 (17.)
 Trefferkreis: 8.99 mm
 Trefferlage: 0.00 mm , 0.17 mm tief

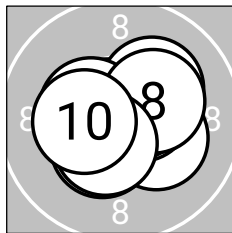
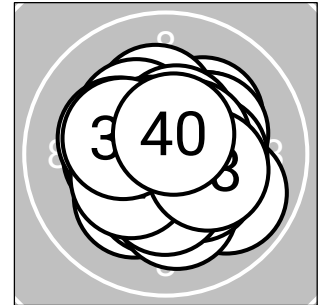
**Serie 1: 104.3 (100)**

10.3*↘	10.4*↙	10.6*↗	10.6*↗	10.7*↖
10.2*↗	10.4*↖	10.3*↗	10.5*↙	10.3*↖

beste Teiler: 66.6 (5.), 87.6 (4.), 96.6 (3.)
 Trefferkreis: 7.92 mm
 Trefferlage: 0.10 mm rechts, 0.09 mm hoch

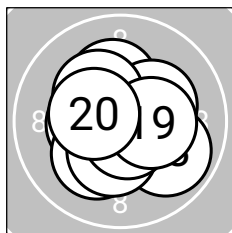
**Serie 2: 103.1 (99)**

10.4*↖	10.2*↙	9.9↘	10.2*↗	10.3*↗
10.4*↙	10.7*↘	10.3*↖	10.3*↗	10.4*↖

beste Teiler: 68.6 (17.), 135.1 (20.), 142.6 (11.)
 Trefferkreis: 8.82 mm
 Trefferlage: 0.00 mm , 0.10 mm tief

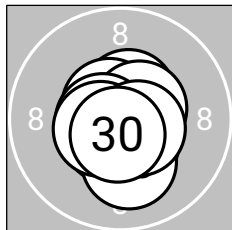
**Serie 3: 105.1 (100)**

10.6*↙	10.4*↘	10.1↓	10.5*↗	10.6*↖
10.5*↗	10.6*↖	10.5*↖	10.6*↘	10.7*↙

beste Teiler: 75.1 (30.), 80.9 (25.), 83.6 (27.)
 Trefferkreis: 7.55 mm
 Trefferlage: 0.01 mm rechts, 0.36 mm tief

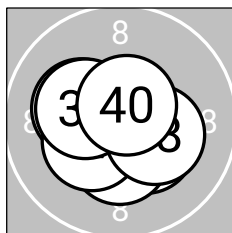
**Serie 4: 104.7 (100)**

10.7*↙	10.2*↖	10.4*↘	10.6*↘	10.4*↙
10.9*↘	10.3*↖	10.3*↘	10.3*↖	10.6*↗

beste Teiler: 11.6 (36.), 70.2 (31.), 76.8 (34.)
 Trefferkreis: 8.02 mm
 Trefferlage: 0.12 mm links, 0.34 mm tief

LG 40 ZR

StandNr: 135

Rudig,, Hannah #70515155

Frauen

Wertung

StartNr: 79

31.01.2026 15:09

SG_Zams

Ergebnis: **416.0** (397)
 Serien: 103.5 104.2 104.3 104.0
 Zähler: 37 3 0 0 0 0 0 0 0 0
 Innenzehner: 33
 Weitestе: 323 (19.), 263 (5.), 252 (37.)
 beste Teiler: 8.0 (2.), 10.1 (12.), 44.2 (16.)
 Trefferkreis: 10.13 mm
 Trefferlage: 0.44 mm links, 0.12 mm tief

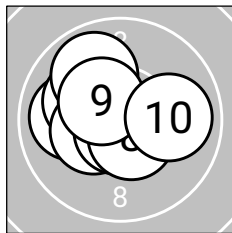
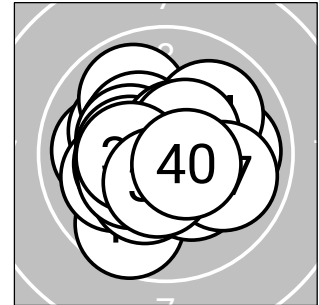
**Serie 1: 103.5** (99)

10.0 ← 10.9* ↓ 10.2* ↙ 10.5* ← 9.9 ↘
 10.4* ↙ 10.7* ↓ 10.5* ↘ 10.4* ↘ 10.0 →

beste Teiler: 8.0 (2.), 58.9 (7.), 102.3 (8.)
 Trefferkreis: 9.46 mm
 Trefferlage: 0.60 mm links, 0.23 mm hoch

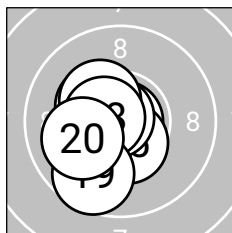
**Serie 2: 104.2** (99)

10.5* ← 10.9* → 10.6* ← 10.3* ↙ 10.5* ↓
 10.8* ↙ 10.3* ↙ 10.6* ← 9.7 ↓ 10.0 ←

beste Teiler: 10.1 (12.), 44.2 (16.), 88.1 (13.)
 Trefferkreis: 8.52 mm
 Trefferlage: 0.89 mm links, 0.26 mm tief

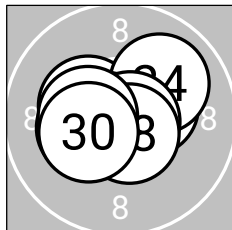
**Serie 3: 104.3** (100)

10.4* → 10.5* ↙ 10.3* ↙ 10.0 → 10.7* ←
 10.8* → 10.3* ↙ 10.6* ↘ 10.4* ← 10.3* ↙

beste Teiler: 46.3 (26.), 74.9 (25.), 77.6 (28.)
 Trefferkreis: 8.39 mm
 Trefferlage: 0.36 mm links, 0.05 mm hoch

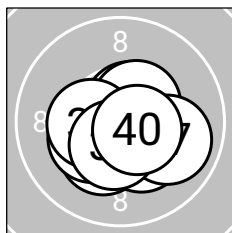
**Serie 4: 104.0** (99)

10.6* ↗ 10.6* ↘ 10.3* ↘ 10.5* ↗ 10.3* ↙
 10.3* ↘ 9.9 → 10.4* ← 10.5* ↓ 10.6* →

beste Teiler: 89.1 (31.), 94.8 (40.), 99.2 (32.)
 Trefferkreis: 8.38 mm
 Trefferlage: 0.09 mm rechts, 0.54 mm tief

LG 40 ZR

StandNr: 136

Mair,, Gerhard #70218006

Männer

Wertung

StartNr: 80

31.01.2026 15:11

SG_Matrei_a._Br.

Ergebnis: **414.8** (396)
 Serien: 103.3 103.9 103.2 104.4
 Zähler: 36 4 0 0 0 0 0 0 0 0
 Innenzehner: 35
 Weitester: 360 (9.), 293 (19.), 274 (1.)
 beste Teiler: 58.3 (18.), 70.0 (3.), 70.2 (17.)
 Trefferkreis: 10.38 mm
 Trefferlage: 0.03 mm links, 0.49 mm tief

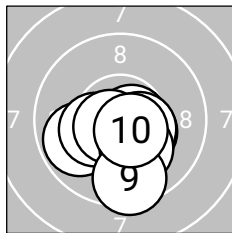
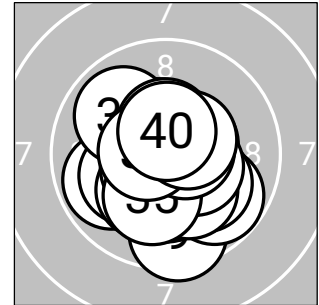
**Serie 1: 103.3** (98)

9.9	10.6*	10.7*	10.4*	10.4*
10.3*	10.7*	10.2*	9.5	10.6*

beste Teiler: 70.0 (3.), 75.4 (7.), 85.8 (2.)
 Trefferkreis: 8.62 mm
 Trefferlage: 0.01 mm rechts, 1.02 mm tief

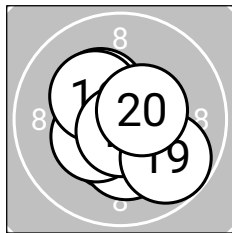
**Serie 2: 103.9** (99)

10.4*	10.5*	10.3*	10.3*	10.4*
10.3*	10.7*	10.7*	9.8	10.5*

beste Teiler: 58.3 (18.), 70.2 (17.), 116.0 (20.)
 Trefferkreis: 9.11 mm
 Trefferlage: 0.07 mm links, 0.45 mm tief

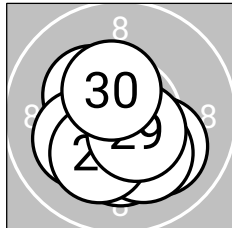
**Serie 3: 103.2** (100)

10.6*	10.3*	10.2*	10.4*	10.1
10.2*	10.2*	10.2*	10.6*	10.4*

beste Teiler: 94.5 (21.), 99.0 (29.), 126.4 (30.)
 Trefferkreis: 8.31 mm
 Trefferlage: 0.04 mm links, 0.77 mm tief

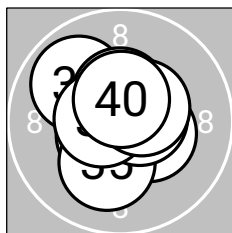
**Serie 4: 104.4** (99)

10.6*	10.6*	9.9	10.4*	10.2*
10.5*	10.6*	10.6*	10.5*	10.5*

beste Teiler: 85.9 (38.), 92.1 (37.), 97.3 (32.)
 Trefferkreis: 8.63 mm
 Trefferlage: 0.02 mm links, 0.26 mm hoch

LG 40 ZR

StandNr: 137

Eberharter,, Stefan #70817185

Männer

Wertung

StartNr: 81

31.01.2026 15:13

SG_Zell_am_Ziller

Ergebnis: **416.8** (400)
 Serien: 104.6 103.8 104.8 103.6
 Zähler: 40 0 0 0 0 0 0 0 0 0 0
 Innenzehner: 34
 Weitester: 249 (39.), 226 (32.), 215 (15.)
 beste Teiler: 17.0 (4.), 36.0 (34.), 54.6 (33.)
 Trefferkreis: 8.61 mm
 Trefferlage: 0.34 mm rechts, 0.34 mm hoch

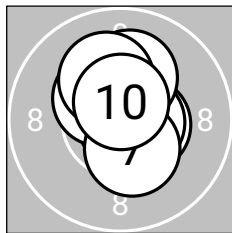
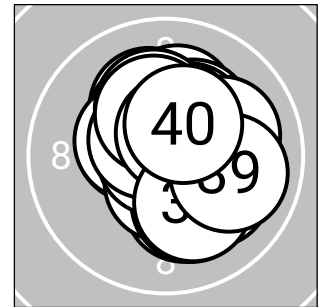

Serie 1: 104.6 (100)

10.2*↑	10.5*→	10.7*→	10.9*→	10.4*↖
10.6*→	10.4*↘	10.1↑	10.2*↖	10.6*↑

beste Teiler: 17.0 (4.), 56.0 (3.), 79.9 (6.)
 Trefferkreis: 7.96 mm
 Trefferlage: 0.23 mm rechts, 0.61 mm hoch

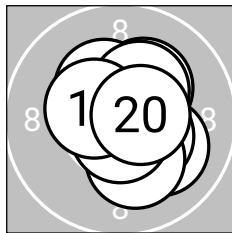

Serie 2: 103.8 (100)

10.2*↗	10.6*↑	10.3*↖	10.3*↗	10.1↘
10.4*↘	10.2*↘	10.7*↓	10.4*↖	10.6*→

beste Teiler: 63.0 (18.), 84.5 (12.), 94.1 (20.)
 Trefferkreis: 8.13 mm
 Trefferlage: 0.43 mm rechts, 0.12 mm hoch

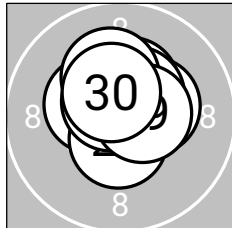

Serie 3: 104.8 (100)

10.4*→	10.4*↑	10.7*↓	10.4*↖	10.5*↗
10.2*↑	10.6*↓	10.6*↖	10.5*→	10.5*↖

beste Teiler: 59.6 (23.), 82.6 (28.), 100.4 (27.)
 Trefferkreis: 7.38 mm
 Trefferlage: 0.07 mm rechts, 0.56 mm hoch

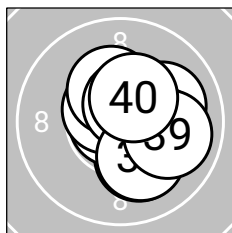

Serie 4: 103.6 (100)

10.1↘	10.0→	10.7*→	10.8*←	10.6*↖
10.3*↑	10.6*↑	10.1↘	10.0→	10.4*↗

beste Teiler: 36.0 (34.), 54.6 (33.), 94.3 (37.)
 Trefferkreis: 8.28 mm
 Trefferlage: 0.64 mm rechts, 0.06 mm hoch



LG 40 ZR

StandNr: 138

Oberhofer,, Johann_sen. #70406002**Senioren_1m**

Wertung

StartNr: 82

31.01.2026 15:15

SG_Bruckhäusl

Ergebnis: **412.5 (398)**
 Serien: 104.8 102.9 102.0 102.8
 Zähler: 38 2 0 0 0 0 0 0 0 0
 Innenzehner: 31
 Weitester: 289 (26.), 259 (8.), 250 (22.)
 beste Teiler: 41.0 (3.), 50.2 (20.), 66.0 (6.)
 Trefferkreis: 9.76 mm
 Trefferlage: 0.27 mm rechts, 0.06 mm tief

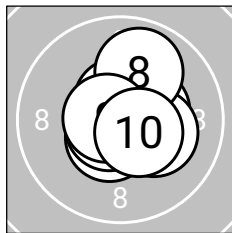
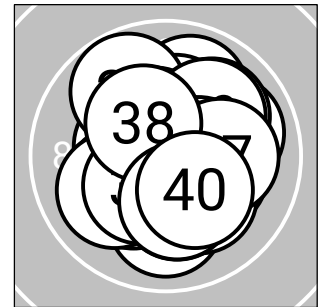
**Serie 1: 104.8 (99)**

10.5*↑	10.6*↑	10.8*←	10.4*→	10.5*↓
10.7*↙	10.2*↘	9.9↑	10.7*←	10.5*↘

beste Teiler: 41.0 (3.), 66.0 (6.), 68.4 (9.)
 Trefferkreis: 8.18 mm
 Trefferlage: 0.28 mm rechts, 0.24 mm hoch

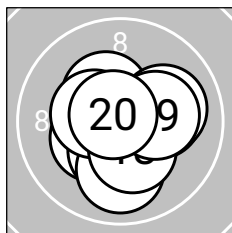
**Serie 2: 102.9 (100)**

10.3*↙	10.3*↓	10.0↓	10.4*↖	10.4*←
10.2*→	10.0→	10.3*↘	10.2*→	10.8*↖

beste Teiler: 50.2 (20.), 137.3 (15.), 150.4 (14.)
 Trefferkreis: 8.63 mm
 Trefferlage: 0.23 mm rechts, 0.28 mm tief

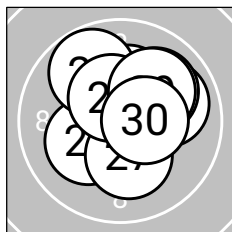
**Serie 3: 102.0 (99)**

10.6*↓	10.0→	10.0↗	10.2*↙	10.3*↑
9.8↖	10.2*↓	10.4*↖	10.1↗	10.4*→

beste Teiler: 88.8 (21.), 127.0 (30.), 127.2 (28.)
 Trefferkreis: 9.28 mm
 Trefferlage: 0.40 mm rechts, 0.57 mm hoch

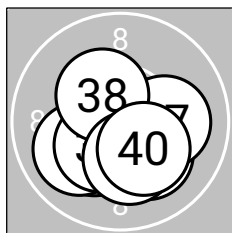
**Serie 4: 102.8 (100)**

10.2*↙	10.0↙	10.4*↙	10.7*→	10.4*↘
10.2*↘	10.1→	10.3*↖	10.2*↓	10.3*↘

beste Teiler: 75.8 (34.), 136.4 (35.), 149.8 (33.)
 Trefferkreis: 8.81 mm
 Trefferlage: 0.19 mm rechts, 0.77 mm tief



Ergebnis: 419.7 (400)
Serien: 104.6 104.6 105.7 104.8
Zähler: 40 0 0 0 0 0 0 0 0 0 0
Innenzehner: 38
Weiteste: 207 (6.), 203 (19.), 199 (21.)
beste Teiler: 34.9 (22.), 35.8 (24.), 50.9 (23.)
Trefferkreis: 8.61 mm
Trefferlage: 0.22 mm links, 0.16 mm tief

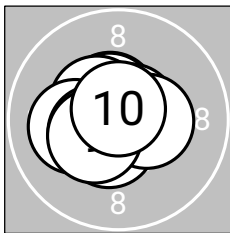
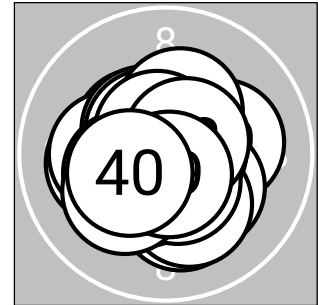

Serie 1: 104.6 (100)

10.5*↓ 10.5*↖ 10.5*↖ 10.7*↗ 10.4*↖
 10.1← 10.4*↖ 10.4*→ 10.4*↖ 10.7*↑

beste Teiler: 52.0 (10.), 70.8 (4.), 102.4 (3.)
Trefferkreis: 7.91 mm
Trefferlage: 0.46 mm links, 0.08 mm hoch

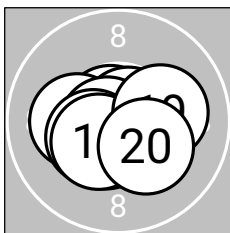

Serie 2: 104.6 (100)

10.5*↓ 10.7*↖ 10.7*↗ 10.6*↓ 10.2*←
 10.7*↖ 10.4*↖ 10.4*↖ 10.1→ 10.3*↘

beste Teiler: 54.4 (12.), 55.0 (16.), 57.1 (13.)
Trefferkreis: 8.45 mm
Trefferlage: 0.22 mm links, 0.37 mm tief

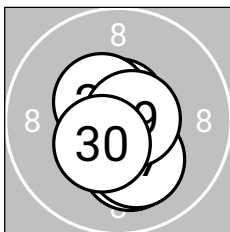

Serie 3: 105.7 (100)

10.2*↓ 10.8*↗ 10.8*↖ 10.8*↓ 10.6*↘
 10.7*↑ 10.2*↓ 10.5*↖ 10.7*→ 10.4*↖

beste Teiler: 34.9 (22.), 35.8 (24.), 50.9 (23.)
Trefferkreis: 7.63 mm
Trefferlage: 0.08 mm rechts, 0.37 mm tief

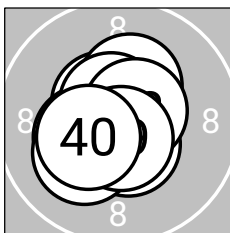

Serie 4: 104.8 (100)

10.6*↗ 10.5*↓ 10.6*↖ 10.3*↑ 10.3*↖
 10.2*↖ 10.6*↖ 10.6*↗ 10.7*↓ 10.4*↖

beste Teiler: 73.9 (39.), 79.3 (37.), 86.8 (38.)
Trefferkreis: 7.98 mm
Trefferlage: 0.28 mm links, 0.01 mm tief



Ergebnis: 419.9 (400)
Serien: 105.1 105.2 104.4 105.2
Zähler: 40 0 0 0 0 0 0 0 0 0 0
Innenzehner: 37
Weiteste: 246 (12.), 237 (30.), 223 (25.)
beste Teiler: 18.7 (20.), 35.1 (5.), 39.8 (24.)
Trefferkreis: 9.15 mm
Trefferlage: 0.13 mm rechts, 0.00 mm

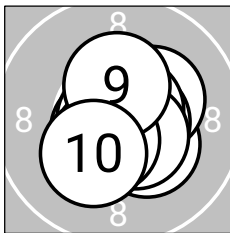
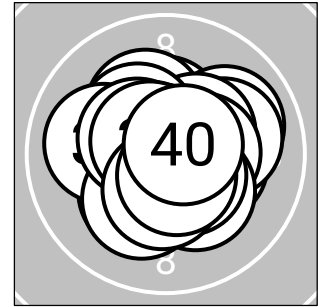

Serie 1: 105.1 (100)

10.3*↘	10.3*↗	10.6*↙	10.6*→	10.8*←
10.7*↗	10.6*↘	10.6*↙	10.4*↑	10.2*↘

beste Teiler: 35.1 (5.), 66.2 (6.), 76.0 (3.)
Trefferkreis: 7.87 mm
Trefferlage: 0.20 mm rechts, 0.18 mm tief

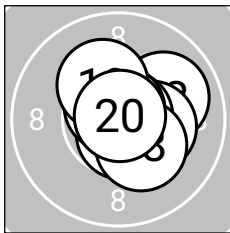

Serie 2: 105.2 (100)

10.6*↘	10.0→	10.3*→	10.7*↓	10.8*→
10.8*↑	10.6*↙	10.3*↘	10.2*↖	10.9*↗

beste Teiler: 18.7 (20.), 44.2 (16.), 45.5 (15.)
Trefferkreis: 8.11 mm
Trefferlage: 0.50 mm rechts, 0.13 mm hoch

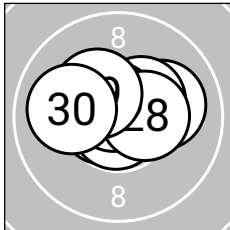

Serie 3: 104.4 (100)

10.7*←	10.7*↖	10.3*↙	10.8*↓	10.1→
10.4*↗	10.7*↖	10.4*→	10.3*↖	10.0←

beste Teiler: 39.8 (24.), 53.7 (22.), 56.4 (27.)
Trefferkreis: 8.99 mm
Trefferlage: 0.13 mm links, 0.44 mm hoch

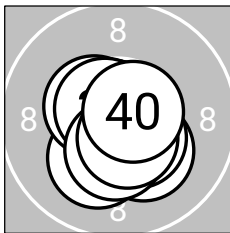

Serie 4: 105.2 (100)

10.7*↖	10.2*↙	10.2*↘	10.8*↖	10.5*↙
10.5*↘	10.6*↙	10.4*↓	10.6*↘	10.7*↗

beste Teiler: 41.2 (34.), 60.8 (31.), 74.7 (40.)
Trefferkreis: 7.47 mm
Trefferlage: 0.03 mm links, 0.37 mm tief



Ergebnis: 415.3 (393)
Serien: 105.4 104.6 102.1 103.2
Zähler: 33 7 0 0 0 0 0 0 0 0
Innenzehner: 32
Weiteste: 391 (29.), 351 (18.), 311 (22.)
beste Teiler: 17.1 (4.), 21.0 (5.), 24.6 (12.)
Trefferkreis: 10.84 mm
Trefferlage: 0.38 mm links, 0.02 mm hoch

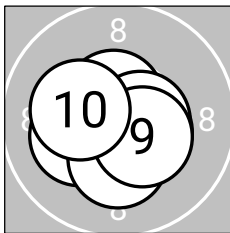
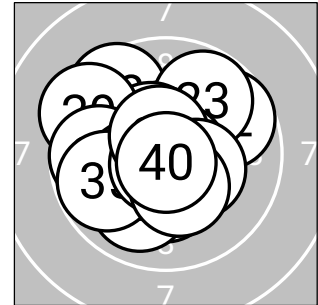

Serie 1: 105.4 (100)

10.8*↑ 10.5*↘ 10.2*← 10.9*↑ 10.9*↘
 10.3*↓ 10.6*↑ 10.6*→ 10.4*↘ 10.2*←

beste Teiler: 17.1 (4.), 21.0 (5.), 39.3 (1.)
Trefferkreis: 7.55 mm
Trefferlage: 0.04 mm links, 0.21 mm tief

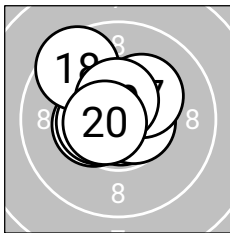

Serie 2: 104.6 (99)

10.4*← 10.9*↘ 10.8*↑ 10.5*↖ 10.5*←
 10.6*→ 10.2*↗ 9.5↖ 10.5*↑ 10.7*←

beste Teiler: 24.6 (12.), 39.0 (13.), 75.1 (20.)
Trefferkreis: 8.67 mm
Trefferlage: 0.38 mm links, 0.53 mm hoch

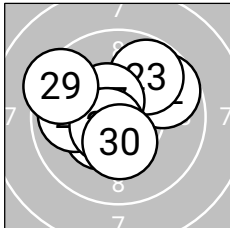

Serie 3: 102.1 (96)

10.8*↑ 9.7↗ 9.8↗ 10.4*↖ 9.9←
 10.6*↖ 10.5*↖ 10.6*↖ 9.4↖ 10.4*↓

beste Teiler: 48.2 (21.), 78.6 (26.), 85.8 (28.)
Trefferkreis: 10.65 mm
Trefferlage: 0.47 mm links, 0.40 mm hoch

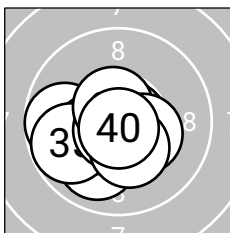

Serie 4: 103.2 (98)

9.7← 10.0↙ 10.7*→ 10.3*↖ 9.8↖
 10.7*↙ 10.6*↑ 10.3*↘ 10.3*↘ 10.8*↓

beste Teiler: 38.0 (40.), 51.0 (33.), 54.3 (36.)
Trefferkreis: 8.91 mm
Trefferlage: 0.63 mm links, 0.62 mm tief



Ergebnis: **418.8** (398)
 Serien: 103.6 105.5 104.6 105.1
 Zähler: 38 2 0 0 0 0 0 0 0 0
 Innenzehner: 37
 Weitester: 480 (5.), 273 (13.), 213 (3.)
 beste Teiler: 0.0 (11.), 44.2 (9.), 47.0 (12.)
 Trefferkreis: 11.71 mm
 Trefferlage: 0.07 mm links, 0.08 mm tief

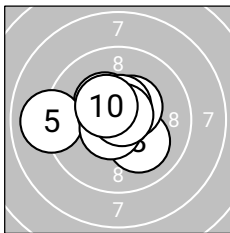
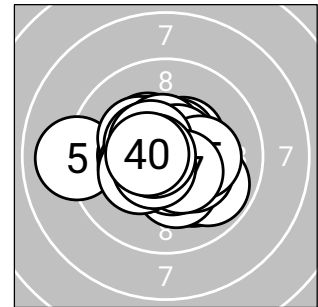

Serie 1: 103.6 (99)

10.3*↖	10.8*↘	10.1↘	10.4*↗	9.0←
10.6*↖	10.6*↗	10.6*↑	10.8*↗	10.4*↖

beste Teiler: 44.2 (9.), 49.5 (2.), 80.7 (7.)
 Trefferkreis: 10.93 mm
 Trefferlage: 0.47 mm links, 0.22 mm hoch

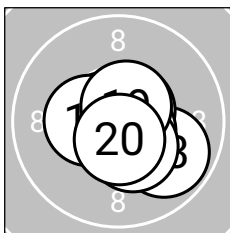

Serie 2: 105.5 (99)

10.9*	10.8*→	9.9↘	10.7*←	10.6*↗
10.6*↘	10.4*←	10.4*↘	10.6*↗	10.6*↓

beste Teiler: 0.0 (11.), 47.0 (12.), 66.0 (14.)
 Trefferkreis: 8.52 mm
 Trefferlage: 0.30 mm rechts, 0.26 mm tief

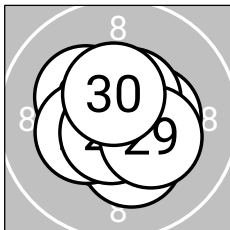

Serie 3: 104.6 (100)

10.6*↙	10.4*→	10.3*↘	10.6*↘	10.3*↖
10.6*↗	10.3*←	10.7*↙	10.3*↘	10.5*↑

beste Teiler: 67.1 (28.), 76.5 (24.), 91.3 (21.)
 Trefferkreis: 7.88 mm
 Trefferlage: 0.06 mm rechts, 0.18 mm tief

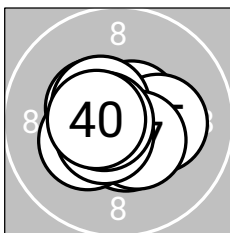

Serie 4: 105.1 (100)

10.6*↘	10.5*↖	10.3*↙	10.6*↗	10.2*→
10.5*↖	10.5*↘	10.6*↙	10.7*←	10.6*←

beste Teiler: 64.0 (39.), 80.8 (34.), 86.3 (38.)
 Trefferkreis: 7.83 mm
 Trefferlage: 0.19 mm links, 0.12 mm tief



Ergebnis: **409.7 (389)**
 Serien: 101.6 102.3 102.4 103.4
 Zähler: 29 11 0 0 0 0 0 0 0 0
 Innenzehner: 26
 Weitester: 399 (16.), 364 (25.), 347 (7.)
 beste Teiler: 21.9 (36.), 48.1 (13.), 51.9 (38.)
 Trefferkreis: 11.93 mm
 Trefferlage: 0.21 mm rechts, 0.04 mm hoch

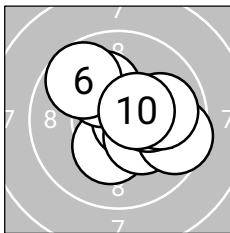
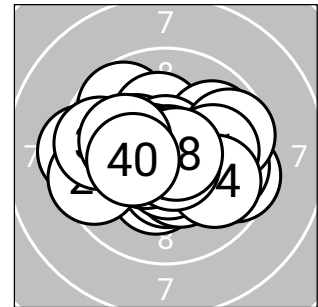

Serie 1: 101.6 (97)

10.3*↓	10.7*→	10.3*→	10.3*↘	10.1↖
9.7↖	9.6↗	10.2*→	9.9→	10.5*↗

beste Teiler: 69.0 (2.), 119.4 (10.), 161.9 (1.)
 Trefferkreis: 10.81 mm
 Trefferlage: 0.89 mm rechts, 0.18 mm hoch

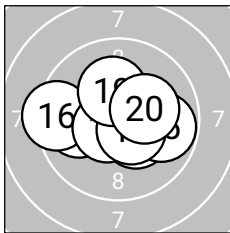

Serie 2: 102.3 (97)

9.9←	10.4*↘	10.8*→	10.5*↗	9.8→
9.4←	10.6*↖	10.5*↘	10.2*↑	10.2*↗

beste Teiler: 48.1 (13.), 90.0 (17.), 107.4 (18.)
 Trefferkreis: 11.32 mm
 Trefferlage: 0.02 mm rechts, 0.06 mm hoch

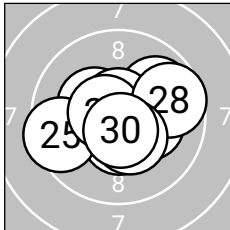

Serie 3: 102.4 (97)

10.2*→	10.5*↓	9.9↗	10.3*↖	9.5←
10.7*↑	10.6*↖	9.7→	10.4*↘	10.6*↓

beste Teiler: 69.0 (26.), 82.2 (30.), 84.7 (27.)
 Trefferkreis: 11.37 mm
 Trefferlage: 0.22 mm rechts, 0.05 mm tief

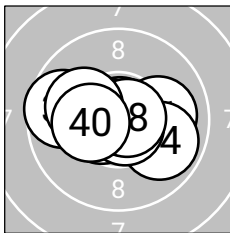

Serie 4: 103.4 (98)

10.0→	9.7←	10.5*↖	9.9↘	10.7*↘
10.9*↗	10.6*↖	10.7*→	10.1←	10.3*↖

beste Teiler: 21.9 (36.), 51.9 (38.), 55.1 (35.)
 Trefferkreis: 10.37 mm
 Trefferlage: 0.29 mm links, 0.00 mm



Ergebnis: 413.2 (398)
Serien: 103.1 102.3 104.3 103.5
Zähler: 38 2 0 0 0 0 0 0 0 0
Innenzehner: 32
Weiteste: 424 (15.), 252 (31.), 244 (9.)
beste Teiler: 60.2 (27.), 69.7 (33.), 75.5 (24.)
Trefferkreis: 11.13 mm
Trefferlage: 0.01 mm links, 0.12 mm hoch

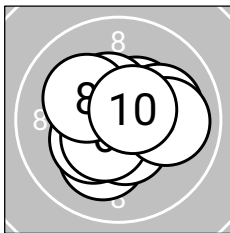
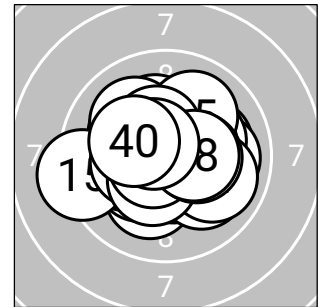

Serie 1: 103.1 (100)

10.4*↗	10.1↘	10.5*↘	10.4*↖	10.3*↖
10.5*↙	10.1→	10.2*↖	10.0→	10.6*↗

beste Teiler: 90.4 (10.), 112.8 (3.), 113.2 (6.)
Trefferkreis: 8.83 mm
Trefferlage: 0.16 mm rechts, 0.05 mm tief

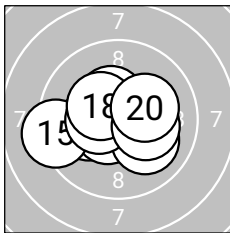

Serie 2: 102.3 (99)

10.2*↖	10.5*→	10.6*↖	10.1↘	9.3↖
10.4*↖	10.4*↖	10.4*↖	10.2*→	10.2*↗

beste Teiler: 99.7 (13.), 106.0 (12.), 126.0 (16.)
Trefferkreis: 10.65 mm
Trefferlage: 0.33 mm links, 0.10 mm tief

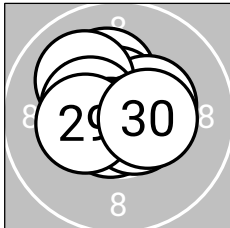

Serie 3: 104.3 (100)

10.2*↖	10.6*↑	10.4*↗	10.7*↖	10.0↖
10.4*↖	10.7*↙	10.6*↗	10.3*↖	10.4*↗

beste Teiler: 60.2 (27.), 75.5 (24.), 81.8 (28.)
Trefferkreis: 7.87 mm
Trefferlage: 0.26 mm links, 0.41 mm hoch

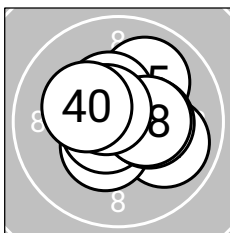

Serie 4: 103.5 (99)

9.9↘	10.4*↙	10.7*↖	10.5*→	10.0↗
10.3*→	10.4*↖	10.4*→	10.6*↖	10.3*↖

beste Teiler: 69.7 (33.), 84.8 (39.), 114.1 (34.)
Trefferkreis: 8.77 mm
Trefferlage: 0.37 mm rechts, 0.23 mm hoch



LG 40 ZR

StandNr: 145

Engensteiner,, Friedl #70515011

Senioren_2m

Wertung

StartNr: 89

31.01.2026 15:24

SG_Zams

Ergebnis: **413.9** (392)
 Serien: 104.5 102.9 102.5 104.0
 Zähler: 33 6 1 0 0 0 0 0 0 0
 Innenzehner: 32
 Weitester: 530 (17.), 314 (7.), 301 (29.)
 beste Teiler: 32.0 (1.), 57.2 (6.), 60.2 (36.)
 Trefferkreis: 12.07 mm
 Trefferlage: 0.04 mm links, 0.36 mm tief

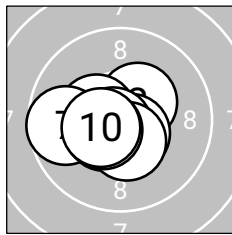
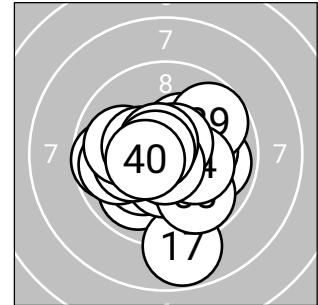

Serie 1: 104.5 (99)

10.8*↑	10.4*↗	10.4*←	10.5*↙	10.6*↘
10.7*↙	9.7←	10.4*↘	10.5*↙	10.5*↙

beste Teiler: 32.0 (1.), 57.2 (6.), 97.0 (5.)
 Trefferkreis: 8.84 mm
 Trefferlage: 0.59 mm links, 0.27 mm tief

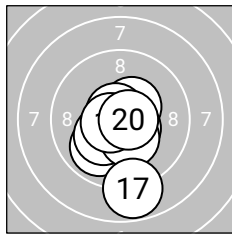

Serie 2: 102.9 (97)

10.7*↘	10.4*↗	10.5*↘	9.9↙	10.3*↙
10.3*↘	8.8↓	10.7*↖	10.6*↙	10.7*→

beste Teiler: 60.8 (18.), 61.1 (20.), 65.1 (11.)
 Trefferkreis: 10.68 mm
 Trefferlage: 0.05 mm rechts, 0.96 mm tief

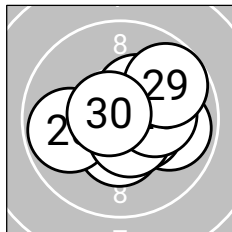

Serie 3: 102.5 (97)

10.4*↓	10.3*→	9.9→	10.5*→	9.8←
10.6*↘	10.4*↗	10.2*→	9.7↗	10.7*↖

beste Teiler: 66.2 (30.), 99.1 (26.), 122.9 (24.)
 Trefferkreis: 10.16 mm
 Trefferlage: 0.77 mm rechts, 0.03 mm tief

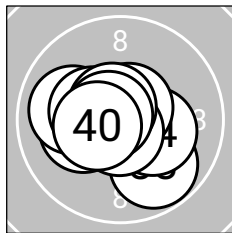

Serie 4: 104.0 (99)

10.2*↙	10.0←	9.8↘	10.3*→	10.7*↗
10.7*↓	10.4*↙	10.7*↖	10.7*↙	10.5*↙

beste Teiler: 60.2 (36.), 63.5 (39.), 75.4 (35.)
 Trefferkreis: 9.44 mm
 Trefferlage: 0.41 mm links, 0.18 mm tief



Ergebnis: **415.9** (399)
 Serien: 103.2 103.1 105.1 104.5
 Zähler: 39 1 0 0 0 0 0 0 0 0
 Innenzehner: 32
 Weitestе: 314 (18.), 250 (2.), 233 (4.)
 beste Teiler: 22.8 (21.), 31.0 (15.), 53.3 (33.)
 Trefferkreis: 9.53 mm
 Trefferlage: 0.25 mm links, 0.27 mm hoch

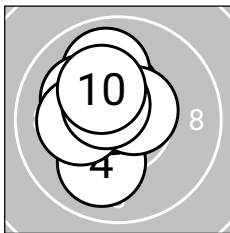
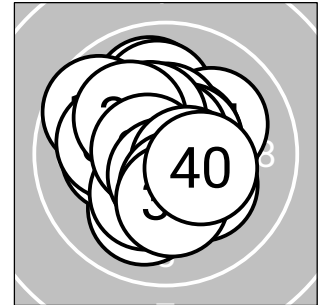

Serie 1: 103.2 (100)

10.4*↑	10.0↑	10.1↖	10.0↓	10.4*↖
10.7*↖	10.2*↖	10.6*↗	10.6*↖	10.2*↖

beste Teiler: 61.0 (6.), 92.7 (8.), 99.4 (9.)
 Trefferkreis: 9.10 mm
 Trefferlage: 0.70 mm links, 0.68 mm hoch

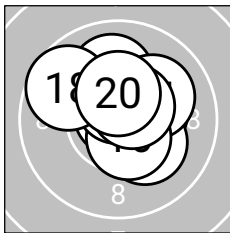

Serie 2: 103.1 (99)

10.3*↗	10.0↑	10.2*↘	10.1↗	10.8*↖
10.5*↘	10.6*↑	9.7↖	10.5*↗	10.4*↑

beste Teiler: 31.0 (15.), 96.1 (17.), 101.9 (19.)
 Trefferkreis: 9.52 mm
 Trefferlage: 0.28 mm rechts, 0.66 mm hoch

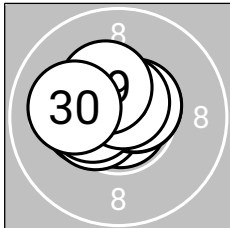

Serie 3: 105.1 (100)

10.9*↘	10.4*↖	10.5*↖	10.6*↗	10.6*↗
10.5*↖	10.5*↖	10.7*↑	10.3*↖	10.1↖

beste Teiler: 22.8 (21.), 74.6 (28.), 95.9 (24.)
 Trefferkreis: 7.43 mm
 Trefferlage: 0.54 mm links, 0.36 mm hoch

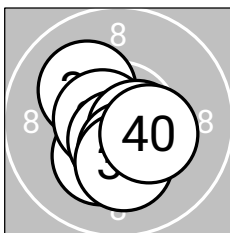

Serie 4: 104.5 (100)

10.3*↘	10.1↖	10.7*↖	10.7*↖	10.5*↓
10.6*↓	10.6*↗	10.4*↓	10.2*↓	10.4*↗

beste Teiler: 53.3 (33.), 74.1 (34.), 83.2 (36.)
 Trefferkreis: 8.22 mm
 Trefferlage: 0.06 mm links, 0.60 mm tief



Ergebnis: **417.3** (397)
 Serien: 103.3 104.4 105.0 104.6
 Zähler: 37 3 0 0 0 0 0 0 0 0
 Innenzehner: 33
 Weitestе: 356 (10.), 323 (1.), 261 (18.)
 beste Teiler: 36.2 (9.), 42.0 (16.), 42.4 (5.)
 Trefferkreis: 11.15 mm
 Trefferlage: 0.17 mm links, 0.06 mm hoch

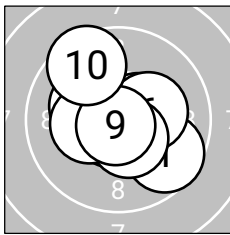
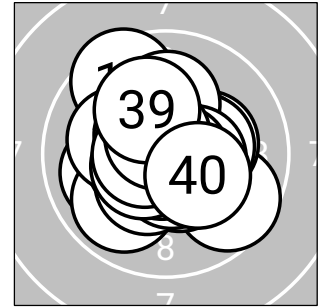

Serie 1: 103.3 (98)

9.7↘	10.5*↗	10.2*↖	10.7*↙	10.8*←
10.3*↗	10.5*↘	10.3*↖	10.8*↙	9.5↘

beste Teiler: 36.2 (9.), 42.4 (5.), 59.6 (4.)
 Trefferkreis: 11.15 mm
 Trefferlage: 0.00 mm , 0.06 mm hoch

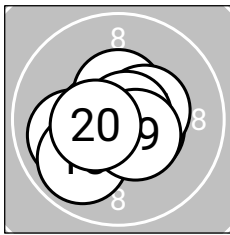

Serie 2: 104.4 (99)

10.7*↘	10.5*↘	10.6*↖	10.5*↑	10.4*↗
10.8*↗	10.0←	9.9↙	10.5*↘	10.5*↖

beste Teiler: 42.0 (16.), 65.2 (11.), 79.0 (13.)
 Trefferkreis: 8.40 mm
 Trefferlage: 0.19 mm links, 0.30 mm tief

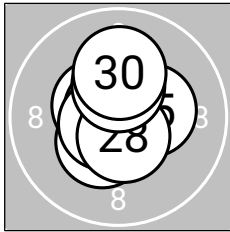

Serie 3: 105.0 (100)

10.7*←	10.6*↖	10.5*↖	10.4*↙	10.3*↗
10.8*↖	10.7*↖	10.6*↘	10.3*↑	10.1↑

beste Teiler: 50.3 (26.), 58.0 (21.), 72.4 (27.)
 Trefferkreis: 7.93 mm
 Trefferlage: 0.19 mm links, 0.30 mm hoch

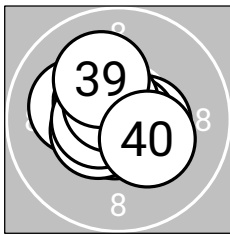

Serie 4: 104.6 (100)

10.5*↗	10.1←	10.7*↓	10.5*↖	10.7*↗
10.5*↖	10.6*←	10.6*↖	10.1↖	10.3*↘

beste Teiler: 52.2 (35.), 55.3 (33.), 82.7 (38.)
 Trefferkreis: 8.21 mm
 Trefferlage: 0.28 mm links, 0.17 mm hoch



Ergebnis: 411.1 (395)
Serien: 102.4 103.2 101.9 103.6
Zähler: 36 3 1 0 0 0 0 0 0 0
Innenzehner: 25
Weiteste: 544 (2.), 303 (31.), 293 (20.)
beste Teiler: 37.2 (5.), 47.5 (13.), 55.9 (32.)
Trefferkreis: 12.55 mm
Trefferlage: 0.48 mm rechts, 0.14 mm hoch

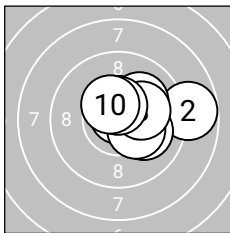
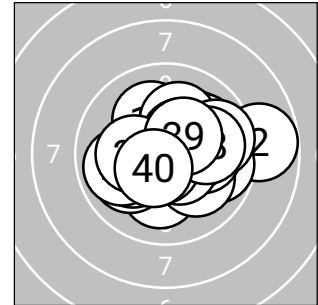

Serie 1: 102.4 (98)

10.5*↑	8.8→	10.1↘	10.7*↑	10.8*↑
10.3*↘	10.1↗	10.2*↗	10.5*↑	10.4*↘

beste Teiler: 37.2 (5.), 57.0 (4.), 109.0 (9.)
Trefferkreis: 10.54 mm
Trefferlage: 1.16 mm rechts, 0.55 mm hoch

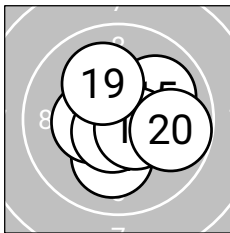

Serie 2: 103.2 (99)

10.3*↘	10.5*↙	10.8*↙	10.1↓	10.0↗
10.4*↙	10.7*↙	10.5*↘	10.1↘	9.8→

beste Teiler: 47.5 (13.), 74.6 (17.), 105.5 (18.)
Trefferkreis: 9.23 mm
Trefferlage: 0.08 mm rechts, 0.00 mm

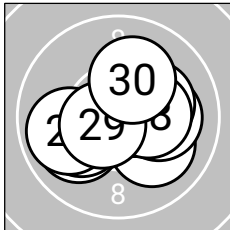

Serie 3: 101.9 (99)

10.1↘	10.1→	10.5*↗	10.0↙	10.1↙
9.9↙	10.2*↗	10.3*↗	10.6*↙	10.1↗

beste Teiler: 91.6 (29.), 109.7 (23.), 156.4 (28.)
Trefferkreis: 9.20 mm
Trefferlage: 0.16 mm rechts, 0.14 mm tief

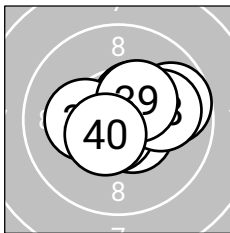

Serie 4: 103.6 (99)

9.7→	10.7*↙	10.4*↗	10.5*↗	10.5*↘
10.7*↙	10.2*↙	10.0→	10.4*↗	10.5*↙

beste Teiler: 55.9 (32.), 68.1 (36.), 104.2 (35.)
Trefferkreis: 9.31 mm
Trefferlage: 0.54 mm rechts, 0.17 mm hoch

