

Ergebnis: **201.2** (192)
 Serien: 102.0 99.2
 Zähler: 12 8 0 0 0 0 0 0 0 0 0
 Innenzehner: 10
 Weitester: 430 (18.), 354 (17.), 321 (5.)
 beste Teiler: 62.3 (10.), 66.4 (16.), 76.6 (9.)
 Trefferkreis: 12.12 mm
 Trefferlage: 0.59 mm links, 0.01 mm hoch

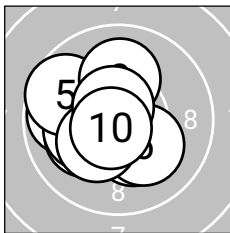
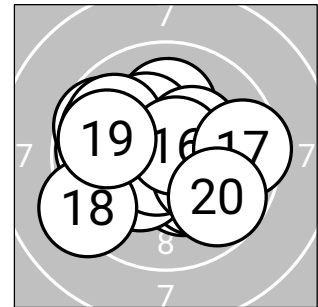

Serie 1: 102.0 (98)

9.8 ←	10.1 ←	10.2* ←	10.3* ↘	9.7 ←
10.2* ↘	10.3* ↙	10.1 ↑	10.6* ↖	10.7* ↙

beste Teiler: 62.3 (10.), 76.6 (9.), 163.1 (4.)
 Trefferkreis: 9.61 mm
 Trefferlage: 0.90 mm links, 0.13 mm tief

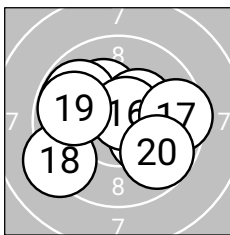

Serie 2: 99.2 (94)

10.2* ↖	10.2* ↘	9.8 ←	10.3* ↗	9.8 ←
10.7* ↗	9.5 →	9.2 ←	9.8 ←	9.7 ↘

beste Teiler: 66.4 (16.), 153.0 (14.), 181.4 (11.)
 Trefferkreis: 12.12 mm
 Trefferlage: 0.29 mm links, 0.15 mm hoch



Ergebnis: 181.2 (174)
Serien: 91.5 89.7
Zähler: 6 7 4 1 2 0 0 0 0 0 0
Innenzehner: 3
Weiteste: 1222 (12.), 1157 (5.), 807 (17.)
beste Teiler: 91.9 (11.), 144.9 (9.), 183.7 (15.)
Trefferkreis: 28.30 mm
Trefferlage: 1.08 mm rechts, 0.29 mm hoch

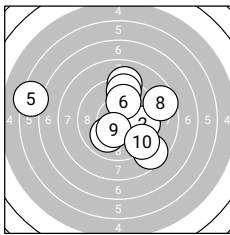
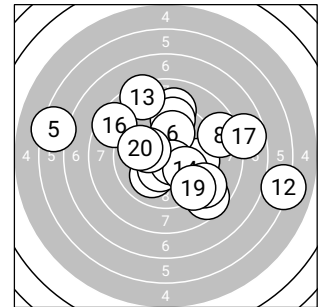

Serie 1: 91.5 (88)

10.0 ↙	9.7 →	9.1 ↑	9.5 ↑	6.3 ←
10.0 ↑	8.6 ↘	8.6 →	10.4* ↘	9.3 ↘

beste Teiler: 144.9 (9.), 237.0 (1.), 239.2 (6.)
Trefferkreis: 21.58 mm
Trefferlage: 0.46 mm rechts, 0.46 mm hoch

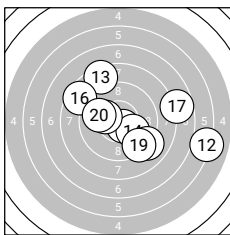

Serie 2: 89.7 (86)

10.6* ↘	6.1 →	8.4 ↖	10.0 ↘	10.2* ←
8.5 ←	7.7 →	9.0 ↘	9.3 ↘	9.9 ←

beste Teiler: 91.9 (11.), 183.7 (15.), 233.5 (14.)
Trefferkreis: 22.58 mm
Trefferlage: 1.70 mm rechts, 0.12 mm hoch



Ergebnis: **190.9** (181)
 Serien: 95.5 95.4
 Zähler: 4 13 3 0 0 0 0 0 0 0 0
 Innenzehner: 2
 Weitestе: 616 (18.), 578 (1.), 531 (15.)
 beste Teiler: 156.4 (11.), 157.7 (6.), 210.7 (20.)
 Trefferkreis: 16.30 mm
 Trefferlage: 0.41 mm links, 0.46 mm hoch

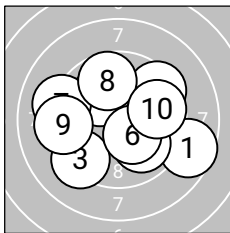
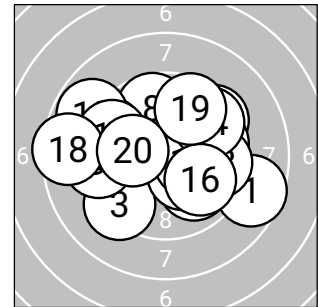

Serie 1: 95.5 (91)

8.6 ➤	10.1 ↖	9.3 ↙	9.5 ↗	9.9 ↘
10.3* ➤	9.1 ↖	9.7 ↗	9.3 ←	9.7 →

beste Teiler: 157.7 (6.), 224.7 (2.), 253.1 (5.)
 Trefferkreis: 14.79 mm
 Trefferlage: 0.04 mm rechts, 0.04 mm hoch

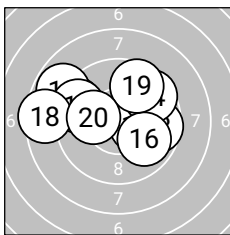

Serie 2: 95.4 (90)

10.3* ➤	9.4 ↖	9.7 ➔	9.6 ↗	8.8 ↖
9.9 ➤	9.5 ↖	8.5 ←	9.6 ↗	10.1 ←

beste Teiler: 156.4 (11.), 210.7 (20.), 263.2 (16.)
 Trefferkreis: 13.88 mm
 Trefferlage: 0.87 mm links, 0.89 mm hoch



Ergebnis: **173.1 (163)**
 Serien: 87.6 85.5
 Zähler: 3 5 5 6 1 0 0 0 0 0 0
 Innenzehner: 2
 Weitester: 1032 (18.), 927 (20.), 916 (6.)
 beste Teiler: 73.1 (7.), 172.9 (4.), 237.6 (8.)
 Trefferkreis: 23.27 mm
 Trefferlage: 1.74 mm links, 1.35 mm hoch

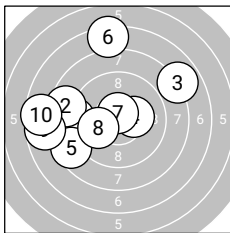
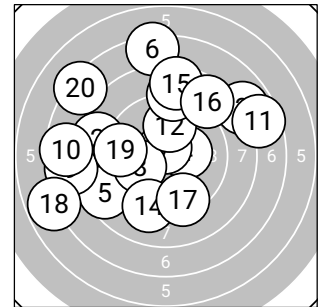

Serie 1: 87.6 (83)

9.0 ← 8.6 ← 7.9 → 10.3* → 8.5 ↙
 7.3 ↑ 10.7* ↑ 10.0 ← 7.7 ← 7.6 ←

beste Teiler: 73.1 (7.), 172.9 (4.), 237.6 (8.)
 Trefferkreis: 19.95 mm
 Trefferlage: 2.74 mm links, 1.13 mm hoch

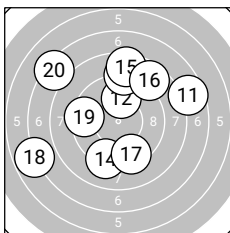

Serie 2: 85.5 (80)

7.6 → 9.9 ↑ 8.9 ↑ 9.2 ↓ 8.5 ↑
 8.6 ↗ 9.4 ↓ 6.8 ← 9.4 ← 7.2 ↙

beste Teiler: 261.0 (12.), 389.3 (19.), 398.6 (17.)
 Trefferkreis: 23.26 mm
 Trefferlage: 0.73 mm links, 1.58 mm hoch



Ergebnis: **190.0** (180)
 Serien: 95.7 94.3
 Zähler: 5 11 3 1 0 0 0 0 0 0 0
 Innenzehner: 4
 Weitester: 843 (16.), 584 (17.), 569 (9.)
 beste Teiler: 125.3 (15.), 145.6 (12.), 159.8 (18.)
 Trefferkreis: 17.33 mm
 Trefferlage: 0.81 mm links, 1.25 mm hoch

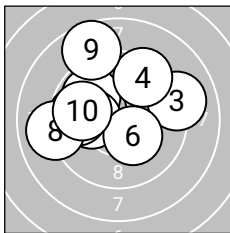
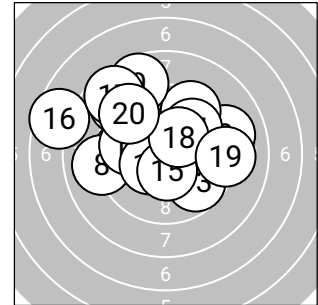

Serie 1: 95.7 (91)

9.6 ↗	9.9 ↖	9.1 →	9.5 ↗	10.1 ←
10.3* ↘	9.7 ←	9.0 ←	8.7 ↖	9.8 ←

beste Teiler: 164.9 (6.), 202.0 (5.), 273.2 (2.)
 Trefferkreis: 14.10 mm
 Trefferlage: 0.66 mm links, 1.24 mm hoch

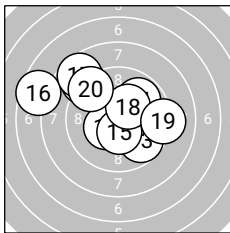

Serie 2: 94.3 (89)

8.9 ↖	10.4* ↖	9.7 ↘	9.8 ↗	10.5* ↓
7.6 ←	8.6 ↖	10.3* ↗	9.2 →	9.3 ↖

beste Teiler: 125.3 (15.), 145.6 (12.), 159.8 (18.)
 Trefferkreis: 17.33 mm
 Trefferlage: 0.95 mm links, 1.26 mm hoch



Ergebnis: **168.0** (160)
 Serien: 82.2 85.8
 Zähler: 3 4 5 6 2 0 0 0 0 0
 Innenzehner: 2
 Weitestе: 1193 (1.), 1073 (3.), 994 (15.)
 beste Teiler: 54.3 (16.), 188.0 (2.), 212.4 (19.)
 Trefferkreis: 26.82 mm
 Trefferlage: 0.57 mm links, 1.64 mm hoch

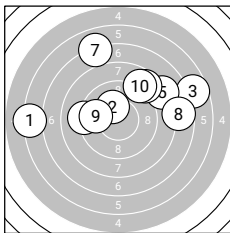
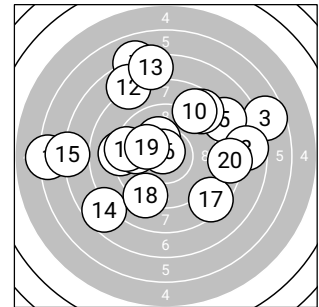

Serie 1: 82.2 (78)

6.2←	10.2*↖	6.7→	9.1←	8.2↗
8.6↗	7.0↖	7.7→	9.7←	8.8↗

beste Teiler: 188.0 (2.), 306.6 (9.), 459.7 (4.)
 Trefferkreis: 26.82 mm
 Trefferlage: 0.71 mm rechts, 2.90 mm hoch

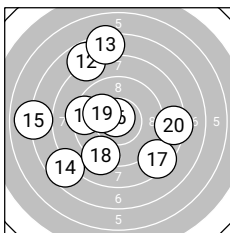

Serie 2: 85.8 (82)

9.3←	7.8↖	7.3↑	7.6↖	7.0←
10.7*↖	8.4↘	9.2↘	10.1←	8.4→

beste Teiler: 54.3 (16.), 212.4 (19.), 402.3 (11.)
 Trefferkreis: 21.03 mm
 Trefferlage: 1.86 mm links, 0.39 mm hoch

Ergebnis: **185.4** (175)
 Serien: 92.7 92.7
 Zähler: 4 9 5 2 0 0 0 0 0 0 0
 Innenzehner: 3
 Weitester: 910 (6.), 803 (19.), 741 (10.)
 beste Teiler: 94.1 (20.), 155.6 (12.), 182.4 (5.)
 Trefferkreis: 20.80 mm
 Trefferlage: 0.95 mm rechts, 0.53 mm tief

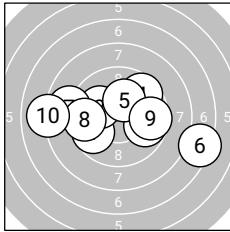
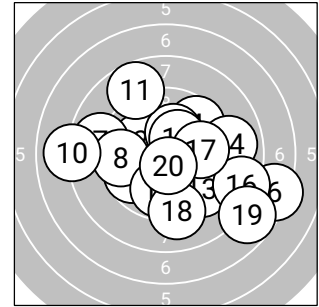

Serie 1: 92.7 (88)

9.7 ← 10.1 ← 9.8 → 9.6 ↗ 10.2* ↗
 7.3 → 8.9 ← 9.5 ← 9.6 → 8.0 ←

beste Teiler: 182.4 (5.), 220.0 (2.), 296.3 (3.)
 Trefferkreis: 20.80 mm
 Trefferlage: 0.29 mm links, 0.01 mm hoch

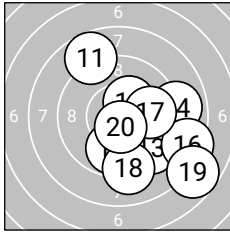

Serie 2: 92.7 (87)

8.7 ↗ 10.3* ↗ 9.4 ↘ 8.9 → 9.8 ↓
 8.4 → 9.8 → 9.1 ↓ 7.7 ↘ 10.6* ↓

beste Teiler: 94.1 (20.), 155.6 (12.), 277.0 (17.)
 Trefferkreis: 17.70 mm
 Trefferlage: 2.20 mm rechts, 1.07 mm tief



Ergebnis: **195.9** (186)
 Serien: 97.0 98.9
 Zähler: 8 10 2 0 0 0 0 0 0 0 0
 Innenzehner: 7
 Weitester: 610 (3.), 541 (18.), 463 (16.)
 beste Teiler: 66.0 (19.), 77.8 (17.), 89.8 (6.)
 Trefferkreis: 14.64 mm
 Trefferlage: 0.79 mm rechts, 1.62 mm hoch

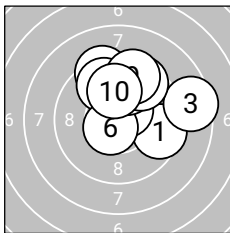
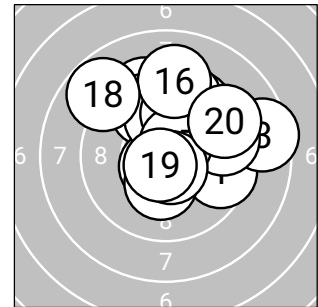

Serie 1: 97.0 (92)

9.5 → 9.3 ↗ 8.5 → 9.7 ↗ 10.5* ↗
 10.6* ↘ 9.9 ↗ 9.5 ↗ 9.5 ↗ 10.0 ↗
 beste Teiler: 89.8 (6.), 101.2 (5.), 238.1 (10.)
 Trefferkreis: 12.28 mm
 Trefferlage: 1.02 mm rechts, 1.86 mm hoch

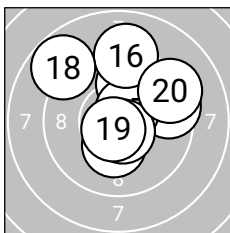

Serie 2: 98.9 (94)

10.2* ↗ 10.3* ↓ 9.5 → 9.9 ↗ 10.5* ↗
 9.1 ↗ 10.6* ↘ 8.8 ↖ 10.7* ↘ 9.3 ↗
 beste Teiler: 66.0 (19.), 77.8 (17.), 102.4 (15.)
 Trefferkreis: 12.41 mm
 Trefferlage: 0.56 mm rechts, 1.38 mm hoch



Ergebnis: **197.3** (187)
 Serien: 99.7 97.6
 Zähler: 10 7 3 0 0 0 0 0 0 0 0
 Innenzehner: 8
 Weitester: 626 (14.), 519 (15.), 514 (13.)
 beste Teiler: 62.0 (17.), 76.0 (12.), 80.7 (5.)
 Trefferkreis: 15.32 mm
 Trefferlage: 0.56 mm rechts, 0.18 mm tief

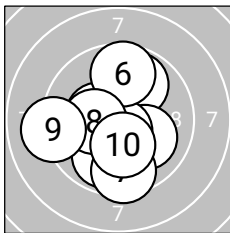
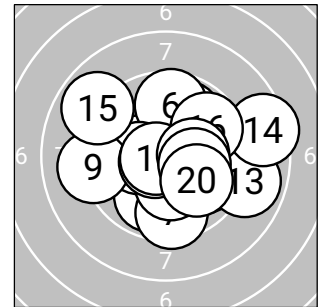

Serie 1: 99.7 (95)

10.4*←	9.9↗	9.9↘	10.1↘	10.6*↓
9.7↑	9.5↓	10.3*←	9.1←	10.2*↓

beste Teiler: 80.7 (5.), 142.8 (1.), 165.5 (8.)
 Trefferkreis: 11.68 mm
 Trefferlage: 0.43 mm links, 0.46 mm tief

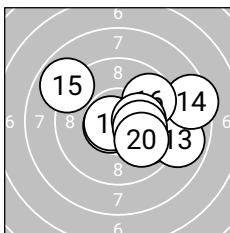

Serie 2: 97.6 (92)

9.9↘	10.6*←	8.9↘	8.4→	8.9↖
9.7↗	10.7*←	10.3*→	10.2*→	10.0↘

beste Teiler: 62.0 (17.), 76.0 (12.), 170.2 (18.)
 Trefferkreis: 14.96 mm
 Trefferlage: 1.57 mm rechts, 0.09 mm hoch



LG 40 ZR

StandNr: 116

Tipotsch,, Alexander #70817186

Jungschützen

Wertung

StartNr: 106

31.01.2026 17:32

SG_Zell_am_Ziller

Ergebnis: **397.4 (379)**
 Serien: 99.7 98.8 99.3 99.6
 Zähler: 21 17 2 0 0 0 0 0 0 0
 Innenzehner: 14
 Weitester: 529 (20.), 502 (24.), 435 (3.)
 beste Teiler: 55.2 (31.), 58.8 (36.), 72.8 (12.)
 Trefferkreis: 14.14 mm
 Trefferlage: 0.34 mm links, 0.31 mm tief

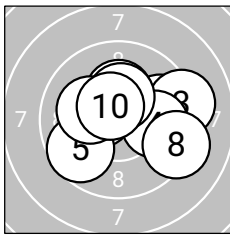
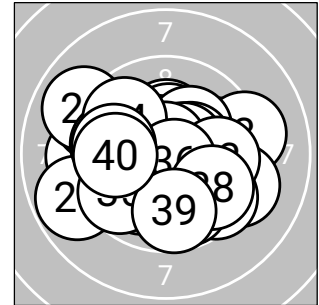

Serie 1: 99.7 (96)

10.4*↖ 9.8→ 9.2→ 10.0→ 9.7↙
 10.3*↑ 10.2*↖ 9.3→ 10.3*↑ 10.5*↙

beste Teiler: 105.3 (10.), 131.5 (1.), 153.9 (9.)
 Trefferkreis: 11.89 mm
 Trefferlage: 0.73 mm rechts, 0.32 mm hoch

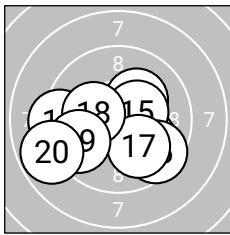

Serie 2: 98.8 (95)

9.3↖ 10.7*↘ 10.0↘ 10.2*↗ 10.4*↗
 9.5↘ 10.0↘ 10.2*↖ 9.7↖ 8.8↖

beste Teiler: 72.8 (12.), 143.1 (15.), 181.9 (18.)
 Trefferkreis: 12.08 mm
 Trefferlage: 0.43 mm links, 0.79 mm tief

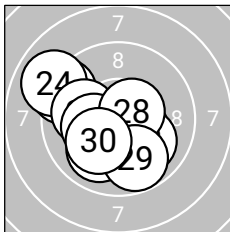

Serie 3: 99.3 (96)

10.4*↘ 10.0↘ 9.3↖ 8.9↖ 10.0↙
 10.0↖ 10.3*↖ 10.5*↗ 9.8↘ 10.1↙

beste Teiler: 105.1 (28.), 146.1 (21.), 174.9 (27.)
 Trefferkreis: 12.03 mm
 Trefferlage: 0.97 mm links, 0.37 mm tief

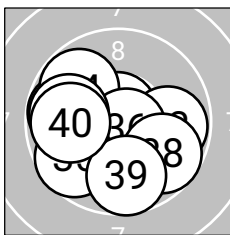

Serie 4: 99.6 (92)

10.7*↑ 9.8↖ 9.8→ 9.8↖ 9.7↙
 10.7*↘ 9.8↖ 9.7↘ 9.7↓ 9.9↖

beste Teiler: 55.2 (31.), 58.8 (36.), 271.0 (40.)
 Trefferkreis: 10.47 mm
 Trefferlage: 0.69 mm links, 0.42 mm tief



Ergebnis: 375.7 (358)
Serien: 94.4 96.1 88.3 96.9
Zähler: 12 19 5 3 1 0 0 0 0 0 0
Innenzehner: 8
Weiteste: 1027 (26.), 869 (15.), 836 (23.)
beste Teiler: 34.8 (9.), 81.8 (38.), 108.1 (17.)
Trefferkreis: 22.03 mm
Trefferlage: 0.90 mm rechts, 0.36 mm hoch

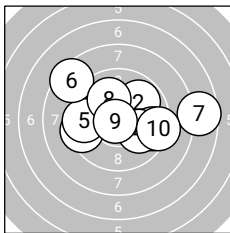
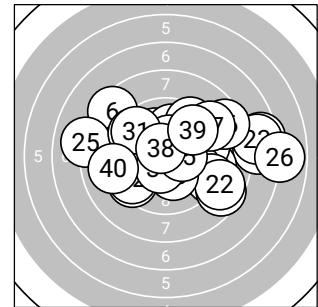

Serie 1: 94.4 (90)
 9.4 ← 9.8 ↗ 9.5 → 10.0 ↘ 9.5 ←
 8.5 ↘ 7.6 → 10.0 ↖ 10.8* ← 9.3 →
beste Teiler: 34.8 (9.), 228.6 (8.), 243.5 (4.)
Trefferkreis: 18.02 mm
Trefferlage: 0.68 mm rechts, 0.41 mm hoch

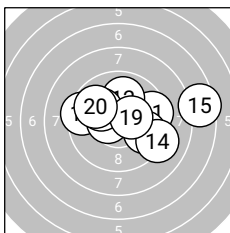

Serie 2: 96.1 (92)
 9.5 → 10.0 ↑ 9.8 ↘ 9.1 ↘ 7.5 →
 9.4 ← 10.5* ← 10.1 ↖ 10.4* → 9.8 ↖
beste Teiler: 108.1 (17.), 142.0 (19.), 217.7 (18.)
Trefferkreis: 16.86 mm
Trefferlage: 1.17 mm rechts, 0.57 mm hoch

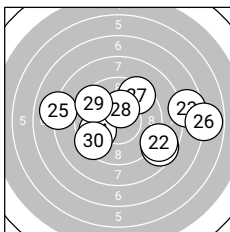

Serie 3: 88.3 (83)
 8.6 ↘ 8.7 ↘ 7.6 → 9.9 ← 8.0 ←
 6.8 → 9.4 ↗ 10.4* ↑ 9.5 ↘ 9.4 ↘
beste Teiler: 147.0 (28.), 273.3 (24.), 359.2 (29.)
Trefferkreis: 22.03 mm
Trefferlage: 1.52 mm rechts, 0.00 mm

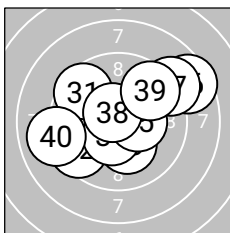

Serie 4: 96.9 (93)
 9.6 ↖ 9.5 ← 10.2* ↓ 10.5* ↓ 10.4* →
 8.5 → 9.0 ↗ 10.6* ↖ 9.6 ↗ 9.0 ←
beste Teiler: 81.8 (38.), 119.5 (34.), 148.0 (35.)
Trefferkreis: 15.31 mm
Trefferlage: 0.25 mm rechts, 0.47 mm hoch



Ergebnis: 380.3 (363)
Serien: 95.3 94.8 91.6 98.6
Zähler: 12 19 9 0 0 0 0 0 0 0
Innenzehner: 9
Weiteste: 665 (29.), 613 (11.), 613 (23.)
beste Teiler: 55.2 (1.), 65.0 (40.), 106.5 (2.)
Trefferkreis: 17.23 mm
Trefferlage: 0.19 mm links, 1.03 mm tief

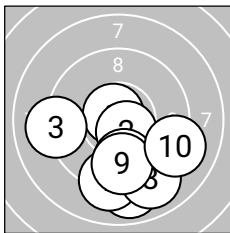
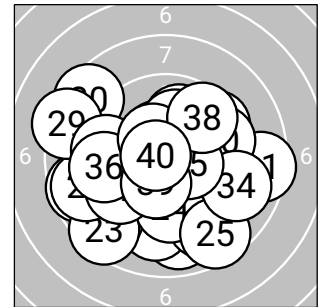

Serie 1: 95.3 (91)

10.7*↖ 10.5*↘ 9.1← 9.3↓ 9.8↓
 8.9↓ 9.2↓ 9.0↘ 9.7↓ 9.1↘

beste Teiler: 55.2 (1.), 106.5 (2.), 295.9 (5.)
Trefferkreis: 13.39 mm
Trefferlage: 0.34 mm rechts, 2.68 mm tief

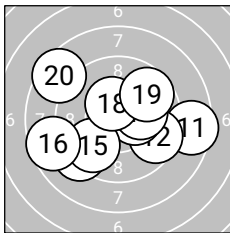

Serie 2: 94.8 (90)

8.5→ 9.6↘ 10.4*→ 9.2↙ 9.7↙
 8.6← 10.2*→ 10.4*↖ 9.7↗ 8.5↖

beste Teiler: 140.0 (18.), 140.4 (13.), 194.5 (17.)
Trefferkreis: 16.59 mm
Trefferlage: 0.13 mm links, 0.14 mm tief

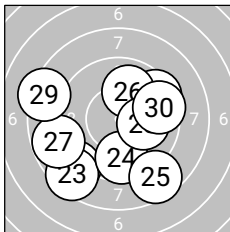

Serie 3: 91.6 (87)

8.7↙ 9.5↗ 8.5↙ 9.6↓ 8.6↘
 10.0↗ 8.8← 10.1→ 8.3← 9.5→

beste Teiler: 215.3 (28.), 248.9 (26.), 330.1 (24.)
Trefferkreis: 16.30 mm
Trefferlage: 0.60 mm links, 1.19 mm tief

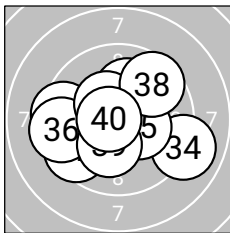

Serie 4: 98.6 (95)

10.1↗ 9.5↙ 9.4← 9.0↘ 10.3*↘
 9.4← 10.4*↖ 9.6↗ 10.2*↓ 10.7*←

beste Teiler: 65.0 (40.), 138.0 (37.), 152.7 (35.)
Trefferkreis: 13.14 mm
Trefferlage: 0.38 mm links, 0.09 mm tief



Ergebnis: 394.5 (377)
Serien: 99.9 97.3 102.4 94.9
Zähler: 21 17 1 0 1 0 0 0 0 0 0
Innenzehner: 18
Weiteste: 1185 (37.), 684 (10.), 446 (11.)
beste Teiler: 43.5 (21.), 70.1 (31.), 83.4 (17.)
Trefferkreis: 19.90 mm
Trefferlage: 0.57 mm links, 0.25 mm hoch

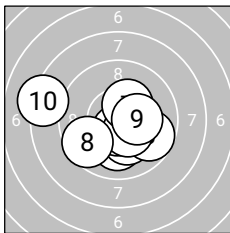
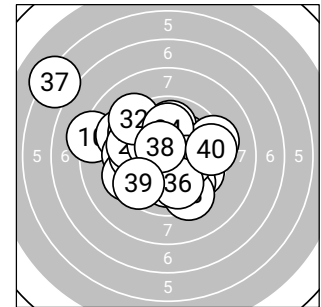

Serie 1: 99.9 (96)

10.1↓	10.2*↓	9.7↘	10.5*↘	10.6*↓
10.4*↘	10.3*↗	9.6↙	10.3*↗	8.2↖

beste Teiler: 93.3 (5.), 120.0 (4.), 132.7 (6.)
Trefferkreis: 14.34 mm
Trefferlage: 0.16 mm links, 0.68 mm tief

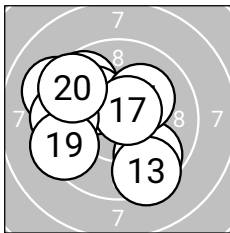

Serie 2: 97.3 (93)

9.2↖	9.7↘	9.4↘	9.7↖	10.1↖
10.2*↗	10.6*↗	9.5↖	9.4↙	9.5↖

beste Teiler: 83.4 (17.), 200.1 (16.), 203.8 (15.)
Trefferkreis: 12.39 mm
Trefferlage: 1.21 mm links, 0.20 mm hoch

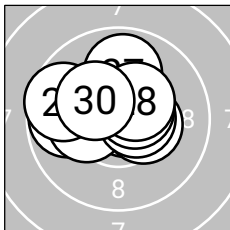

Serie 3: 102.4 (97)

10.8*↗	9.8↖	10.4*↗	10.2*↖	10.5*↗
10.5*↗	9.9↑	10.4*↗	9.6↖	10.3*↖

beste Teiler: 43.5 (21.), 104.0 (25.), 110.6 (26.)
Trefferkreis: 9.28 mm
Trefferlage: 0.40 mm links, 0.58 mm hoch

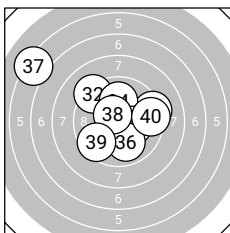

Serie 4: 94.9 (91)

10.7*↘	9.2↖	9.3↗	10.0↑	10.2*↗
9.9↓	6.2↖	10.5*↖	9.5↙	9.4↗

beste Teiler: 70.1 (31.), 103.7 (38.), 177.5 (35.)
Trefferkreis: 19.46 mm
Trefferlage: 0.51 mm links, 0.91 mm hoch



Ergebnis: 584.7 (556)
Serien: 98.7 97.7 96.4 100.3 93.8 97.8
Zähler: 24 29 6 1 0 0 0 0 0 0
Innenzehner: 16
Weiteste: 997 (47.), 739 (42.), 645 (59.)
beste Teiler: 13.0 (51.), 37.4 (11.), 65.3 (15.)
Trefferkreis: 21.74 mm
Trefferlage: 0.39 mm links, 0.01 mm tief

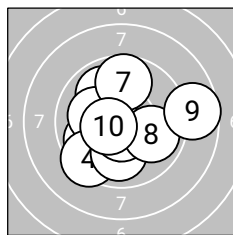
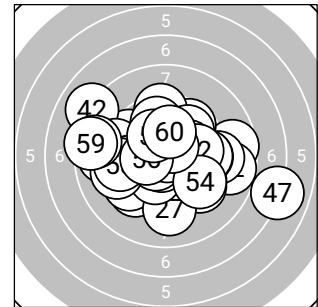

Serie 1: 98.7 (93)
 9.9↙ 9.9↖ 10.1↖ 9.4↗ 10.0↓
 10.6*↓ 9.7↑ 9.9➤ 8.7➤ 10.5*↖
beste Teiler: 91.0 (6.), 107.5 (10.), 208.3 (3.)
Trefferkreis: 13.53 mm
Trefferlage: 0.12 mm links, 0.23 mm tief

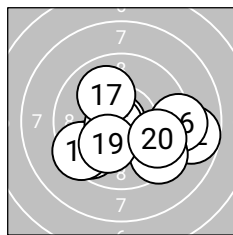

Serie 2: 97.7 (93)
 10.8*↖ 8.7➤ 9.7↙ 9.4↙ 10.7*↖
 9.2➤ 10.0↖ 9.4➤ 10.1↙ 9.7➤
beste Teiler: 37.4 (11.), 65.3 (15.), 202.3 (19.)
Trefferkreis: 13.10 mm
Trefferlage: 0.68 mm rechts, 0.95 mm tief

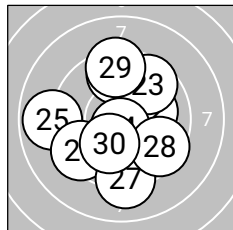

Serie 3: 96.4 (92)
 9.6↑ 10.1➤ 9.6↗ 10.7*↓ 8.9↖
 9.4↙ 9.1↓ 9.5➤ 9.4↑ 10.1↙
beste Teiler: 67.4 (24.), 205.2 (30.), 209.3 (22.)
Trefferkreis: 13.11 mm
Trefferlage: 0.28 mm links, 0.11 mm tief

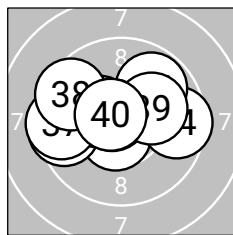

Serie 4: 100.3 (95)
 10.6*↙ 9.5↖ 10.4*↖ 9.6➤ 9.8↗
 10.7*↖ 9.5↖ 9.5↖ 10.1➤ 10.6*↖
beste Teiler: 70.2 (36.), 79.6 (40.), 88.6 (31.)
Trefferkreis: 11.70 mm
Trefferlage: 0.62 mm links, 0.45 mm hoch

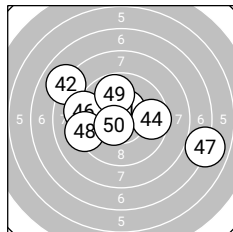

Serie 5: 93.8 (90)
 10.5*↗ 8.0↖ 10.3*↖ 9.6➤ 9.7↖
 9.2↖ 7.0➤ 9.2↖ 9.8↑ 10.5*↖
beste Teiler: 108.7 (50.), 118.3 (41.), 164.4 (43.)
Trefferkreis: 21.74 mm
Trefferlage: 0.75 mm links, 0.35 mm hoch

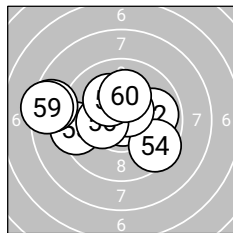

Serie 6: 97.8 (93)
 10.9*➤ 9.9➤ 9.4↖ 9.5➤ 10.6*↗
 10.3*↖ 10.2*↖ 8.5↖ 8.4↖ 10.1↑
beste Teiler: 13.0 (51.), 97.3 (55.), 164.2 (56.)
Trefferkreis: 14.31 mm
Trefferlage: 1.23 mm links, 0.41 mm hoch



Ergebnis: **619.2 (595)**
 Serien: 102.7 102.6 103.5 102.9 103.7 103.8
 Zähler: 55 5 0 0 0 0 0 0 0 0
 Innenzehner: 46
 Weitester: 414 (13.), 302 (19.), 282 (31.)
 beste Teiler: 43.9 (18.), 50.9 (48.), 56.7 (42.)
 Trefferkreis: 11.16 mm
 Trefferlage: 0.07 mm links, 0.03 mm tief

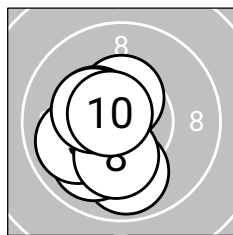
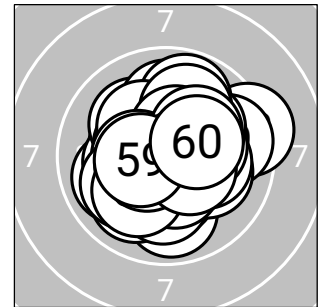

Serie 1: 102.7 (98)

10.6*↖	10.3*↖	9.9↓	10.0↖	9.9↖
10.4*↑	10.4*↖	10.2*↓	10.3*↖	10.7*↖

beste Teiler: 74.6 (10.), 82.1 (1.), 127.0 (6.)
 Trefferkreis: 8.52 mm
 Trefferlage: 0.90 mm links, 0.46 mm tief

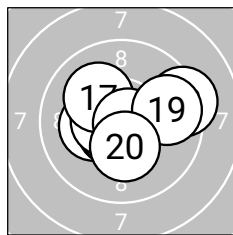

Serie 2: 102.6 (98)

10.2*←	10.4*↖	9.3→	10.6*↖	10.7*↖
10.5*←	10.1↖	10.8*→	9.7→	10.3*↓

beste Teiler: 43.9 (18.), 75.4 (15.), 80.6 (14.)
 Trefferkreis: 10.43 mm
 Trefferlage: 0.12 mm rechts, 0.10 mm hoch

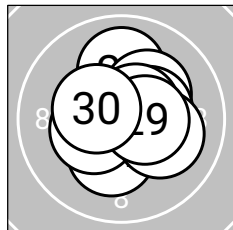

Serie 3: 103.5 (100)

10.0↑	10.2*↗	10.6*↖	10.3*↓	10.4*→
10.4*↖	10.1→	10.6*↗	10.5*→	10.4*↖

beste Teiler: 91.4 (28.), 99.0 (23.), 120.1 (29.)
 Trefferkreis: 8.68 mm
 Trefferlage: 0.26 mm rechts, 0.16 mm hoch

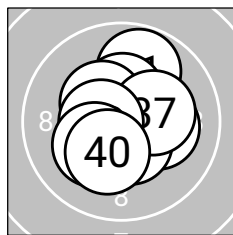

Serie 4: 102.9 (99)

9.8↑	10.4*↑	10.4*↖	10.2*→	10.5*↓
10.4*↖	10.3*→	10.5*←	10.2*↖	10.2*↖

beste Teiler: 108.0 (38.), 118.7 (35.), 139.1 (32.)
 Trefferkreis: 9.09 mm
 Trefferlage: 0.02 mm links, 0.03 mm hoch

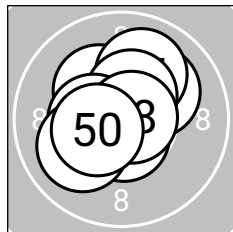

Serie 5: 103.7 (100)

10.1↗	10.7*↗	10.6*↓	10.2*↖	10.0↗
10.5*↗	10.4*←	10.8*→	10.0↖	10.4*↖

beste Teiler: 50.9 (48.), 56.7 (42.), 79.9 (43.)
 Trefferkreis: 9.01 mm
 Trefferlage: 0.15 mm links, 0.40 mm hoch

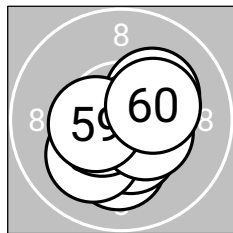

Serie 6: 103.8 (100)

10.2*↗	10.6*↘	10.1↓	10.6*→	10.4*↓
10.1↖	10.6*↖	10.4*↘	10.5*←	10.3*→

beste Teiler: 76.0 (54.), 77.6 (52.), 100.2 (57.)
 Trefferkreis: 8.45 mm
 Trefferlage: 0.23 mm rechts, 0.47 mm tief



Ergebnis: **615.3 (587)**
 Serien: 102.1 103.6 99.8 101.9 103.2 104.7
 Zähler: 47 13 0 0 0 0 0 0 0 0
 Innenzehner: 39
 Weitester: 423 (23.), 423 (26.), 330 (40.)
 beste Teiler: 7.0 (55.), 27.3 (50.), 33.5 (44.)
 Trefferkreis: 12.95 mm
 Trefferlage: 0.36 mm links, 0.06 mm hoch

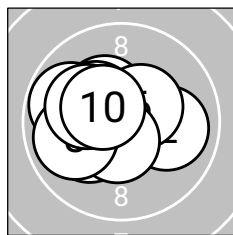
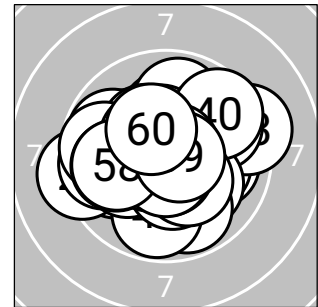

Serie 1: 102.1 (98)

9.8↙	10.0→	10.3*↖	10.3*↖	10.2*↖
10.4*↗	10.5*↓	9.9↙	10.2*↖	10.5*↖

beste Teiler: 103.1 (7.), 125.4 (10.), 131.8 (6.)
 Trefferkreis: 9.75 mm
 Trefferlage: 0.86 mm links, 0.23 mm hoch

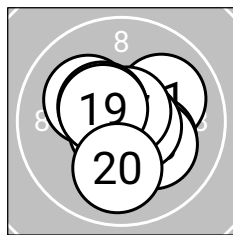

Serie 2: 103.6 (100)

10.0↗	10.2*↘	10.2*↘	10.6*↘	10.2*↖
10.7*↖	10.7*↗	10.5*↖	10.5*↖	10.0↓

beste Teiler: 55.9 (17.), 57.2 (16.), 83.1 (14.)
 Trefferkreis: 8.98 mm
 Trefferlage: 0.20 mm rechts, 0.10 mm tief

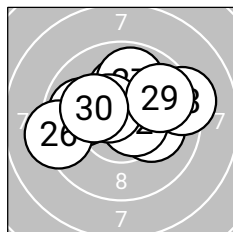

Serie 3: 99.8 (95)

10.1→	10.6*→	9.3→	9.9↙	10.2*↑
9.3↙	9.9↑	10.5*↖	9.8↗	10.2*↖

beste Teiler: 86.3 (22.), 116.6 (28.), 195.0 (25.)
 Trefferkreis: 12.95 mm
 Trefferlage: 0.06 mm rechts, 0.82 mm hoch

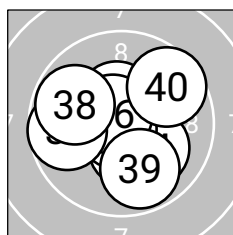

Serie 4: 101.9 (96)

10.4*↑	10.4*↓	10.6*←	10.1↘	10.8*↖
10.7*↖	9.7↙	9.8↙	9.8↘	9.6↗

beste Teiler: 39.8 (35.), 71.5 (36.), 94.0 (33.)
 Trefferkreis: 10.74 mm
 Trefferlage: 0.20 mm links, 0.09 mm tief

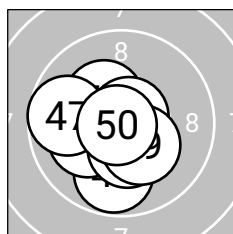

Serie 5: 103.2 (98)

9.8↓	10.3*↖	10.3*←	10.8*↘	10.1↙
10.4*↓	9.7↙	10.7*↗	10.3*↘	10.8*↖

beste Teiler: 27.3 (50.), 33.5 (44.), 55.3 (48.)
 Trefferkreis: 8.97 mm
 Trefferlage: 0.61 mm links, 0.49 mm tief

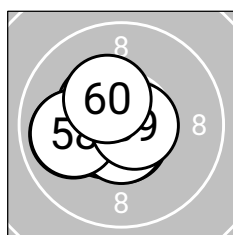

Serie 6: 104.7 (100)

10.0↙	10.7*↓	10.5*↖	10.6*↖	10.9*→
10.4*↖	10.6*↓	10.0↙	10.7*→	10.3*↖

beste Teiler: 7.0 (55.), 68.0 (59.), 72.1 (52.)
 Trefferkreis: 7.67 mm
 Trefferlage: 0.76 mm links, 0.00 mm



Ergebnis: 624.0 (594)
Serien: 104.6 104.0 102.6 103.7 104.2 104.9
Zähler: 54 6 0 0 0 0 0 0 0 0
Innenzehner: 51
Weiteste: 287 (23.), 287 (48.), 285 (4.)
beste Teiler: 27.7 (1.), 40.2 (53.), 54.2 (58.)
Trefferkreis: 10.19 mm
Trefferlage: 0.42 mm rechts, 0.17 mm tief

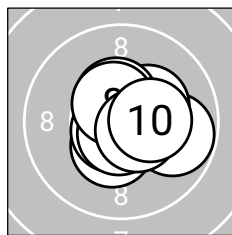
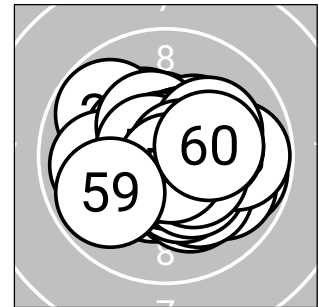

Serie 1: 104.6 (99)

10.8*↘	10.4*↘	10.7*↙	9.8→	10.7*↘
10.3*↗	10.5*↗	10.5*↗	10.6*↗	10.3*↗

beste Teiler: 27.7 (1.), 64.3 (5.), 67.8 (3.)
Trefferkreis: 8.22 mm
Trefferlage: 0.49 mm rechts, 0.07 mm tief

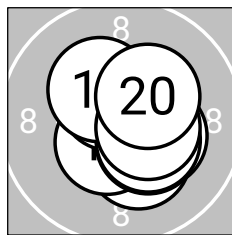

Serie 2: 104.0 (100)

10.3*↘	10.5*↙	10.4*↘	10.3*↗	10.5*↗
10.5*↗	10.4*↘	10.3*↙	10.5*↗	10.3*↗

beste Teiler: 104.2 (15.), 108.7 (12.), 108.7 (16.)
Trefferkreis: 7.84 mm
Trefferlage: 0.45 mm rechts, 0.05 mm tief

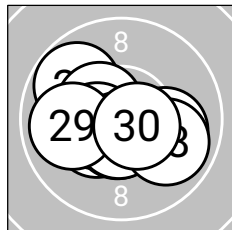

Serie 3: 102.6 (97)

10.4*↙	10.6*↘	9.8↖	10.4*↖	10.4*↖
10.6*↘	10.0→	9.9↗	9.9↖	10.6*↗

beste Teiler: 85.9 (26.), 88.5 (22.), 89.0 (30.)
Trefferkreis: 9.97 mm
Trefferlage: 0.34 mm links, 0.29 mm tief

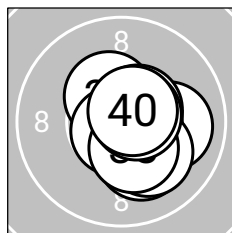

Serie 4: 103.7 (100)

10.0→	10.4*↗	10.2*↘	10.2*↘	10.1↘
10.5*↗	10.7*↘	10.4*↘	10.6*↗	10.6*↗

beste Teiler: 55.2 (37.), 78.5 (40.), 83.3 (39.)
Trefferkreis: 8.01 mm
Trefferlage: 0.77 mm rechts, 0.38 mm tief

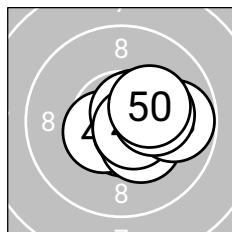

Serie 5: 104.2 (99)

10.6*↘	10.5*↙	10.6*↗	10.6*↗	10.3*↘
10.7*↗	10.6*↗	9.8→	10.2*↗	10.3*↗

beste Teiler: 72.1 (46.), 77.6 (41.), 77.8 (47.)
Trefferkreis: 8.38 mm
Trefferlage: 0.90 mm rechts, 0.10 mm tief

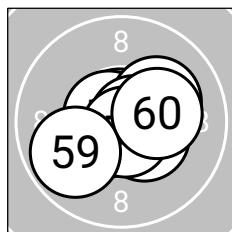

Serie 6: 104.9 (99)

10.6*↙	10.7*↗	10.8*↗	10.7*↖	10.4*↗
10.2*↗	10.7*↗	10.7*↘	9.9↖	10.2*↗

beste Teiler: 40.2 (53.), 54.2 (58.), 66.2 (57.)
Trefferkreis: 9.25 mm
Trefferlage: 0.25 mm rechts, 0.11 mm tief



LG 60 ZR

StandNr: 111

Messner,, Helena #70201125**Frauen**

Wertung

StartNr: 101

31.01.2026 17:38

SG_Absam

Ergebnis: **602.6** (574)
 Serien: 99.4 101.0 99.0 100.4 103.8 99.0
 Zähler: 35 24 1 0 0 0 0 0 0 0
 Innenzehner: 29
 Weitester: 640 (60.), 497 (50.), 459 (39.)
 beste Teiler: 33.7 (24.), 38.0 (41.), 50.4 (49.)
 Trefferkreis: 15.30 mm
 Trefferlage: 0.20 mm rechts, 0.28 mm hoch

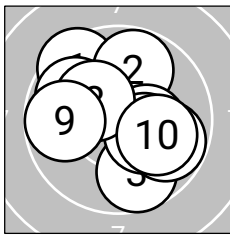
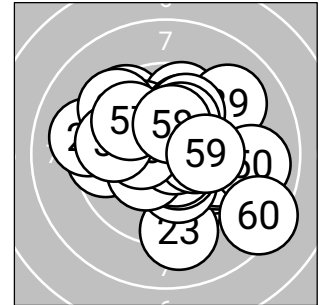
**Serie 1: 99.4** (94)

9.5 ↖	9.8 ↗	9.7 ↘	10.3* →	10.3* ↘
9.8 ↘	9.9 ↖	10.3* ↖	9.8 ←	10.0 →

beste Teiler: 159.6 (4.), 163.7 (5.), 170.2 (8.)
 Trefferkreis: 11.18 mm
 Trefferlage: 0.06 mm rechts, 0.18 mm hoch

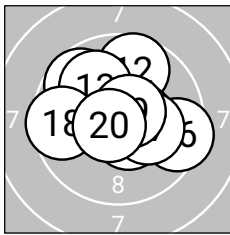
**Serie 2: 101.0** (96)

9.7 ↖	9.7 ↗	10.0 ↖	10.5* →	10.5* ↘
9.5 →	10.2* →	9.6 ←	10.6* ↗	10.7* ↖

beste Teiler: 67.6 (20.), 83.0 (19.), 106.6 (15.)
 Trefferkreis: 11.63 mm
 Trefferlage: 0.11 mm rechts, 0.46 mm hoch

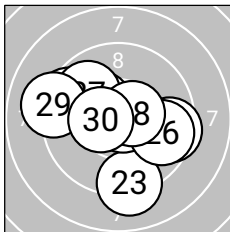
**Serie 3: 99.0** (94)

9.5 →	10.3* ↖	9.2 ↘	10.8* →	9.5 ↖
9.7 →	9.9 ↖	10.5* →	9.1 ←	10.5* ←

beste Teiler: 33.7 (24.), 103.8 (28.), 121.1 (30.)
 Trefferkreis: 12.78 mm
 Trefferlage: 0.39 mm links, 0.07 mm tief

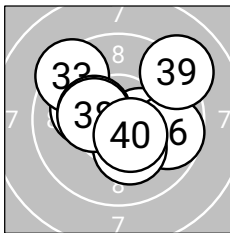
**Serie 4: 100.4** (97)

10.1 ←	10.4* →	9.4 ↖	10.3* ←	10.3* ↘
9.7 →	10.2* ↘	10.4* ←	9.1 ↗	10.5* ↘

beste Teiler: 119.6 (40.), 137.7 (32.), 150.6 (38.)
 Trefferkreis: 11.39 mm
 Trefferlage: 0.26 mm rechts, 0.19 mm hoch

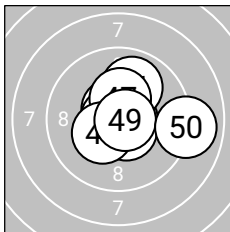
**Serie 5: 103.8** (98)

10.8* ↖	10.6* ↖	10.7* →	10.7* ←	10.6* ↘
9.9 ↗	10.4* ↗	10.3* ↖	10.8* →	9.0 →

beste Teiler: 38.0 (41.), 50.4 (49.), 51.3 (44.)
 Trefferkreis: 10.62 mm
 Trefferlage: 0.55 mm rechts, 0.25 mm hoch

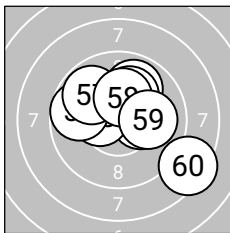
**Serie 6: 99.0** (95)

10.1 ↗	10.3* →	10.4* ←	9.9 ↗	10.1 ↗
9.7 ←	9.8 ↖	10.3* ↗	10.0 →	8.4 ↘

beste Teiler: 142.0 (53.), 169.0 (52.), 175.5 (58.)
 Trefferkreis: 13.82 mm
 Trefferlage: 0.61 mm rechts, 0.71 mm hoch



LG 60 ZR

StandNr: 112

Gisser,, Elisabeth #70609243

Frauen

Wertung

StartNr: 102

31.01.2026 17:27

SG_Lienz_SSV

Ergebnis: **605.1** (579)
 Serien: 100.6 100.9 101.6 100.4 99.3 102.3
 Zähler: 39 21 0 0 0 0 0 0 0 0
 Innenezehner: 27
 Weitestе: 441 (45.), 421 (10.), 411 (19.)
 beste Teiler: 26.0 (54.), 41.1 (58.), 44.2 (2.)
 Trefferkreis: 12.53 mm
 Trefferlage: 0.02 mm rechts, 0.18 mm hoch

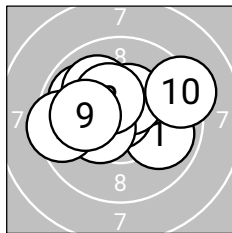
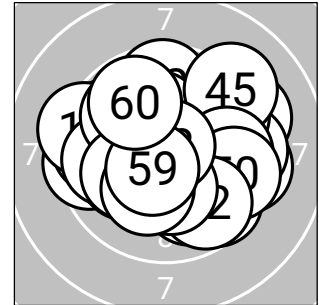
**Serie 1: 100.6** (96)

9.9↘	10.8*↖	9.9↘	10.4*↗	10.4*↖
10.0↖	9.5↖	10.3*↖	10.1↖	9.3↗

beste Teiler: 44.2 (2.), 137.4 (5.), 139.0 (4.)
 Trefferkreis: 12.33 mm
 Trefferlage: 0.51 mm links, 0.63 mm hoch

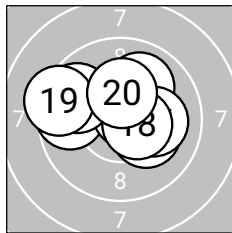
**Serie 2: 100.9** (97)

10.0↗	10.2*↘	10.4*↗	9.7↖	10.7*↗
9.7↖	10.1↗	10.5*↗	9.3↖	10.3*↗

beste Teiler: 60.4 (15.), 113.6 (18.), 126.5 (13.)
 Trefferkreis: 10.71 mm
 Trefferlage: 0.20 mm links, 0.54 mm hoch

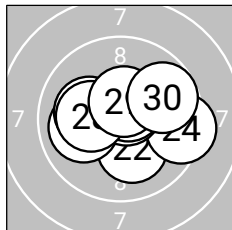
**Serie 3: 101.6** (98)

10.2*↖	10.2*↘	10.0↖	9.4↗	10.7*↗
10.6*↗	10.1↖	10.2*↖	10.5*↗	9.7↗

beste Teiler: 68.2 (25.), 96.5 (26.), 113.3 (29.)
 Trefferkreis: 10.70 mm
 Trefferlage: 0.03 mm rechts, 0.19 mm hoch

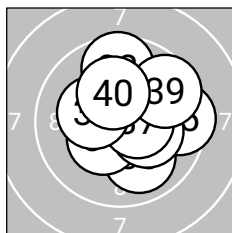
**Serie 4: 100.4** (97)

10.0↗	9.6↗	10.0↘	10.4*↖	9.5↗
10.3*↗	10.5*↗	10.3*↖	9.6↗	10.2*↗

beste Teiler: 107.0 (37.), 147.0 (34.), 175.1 (38.)
 Trefferkreis: 10.13 mm
 Trefferlage: 0.93 mm rechts, 0.42 mm hoch

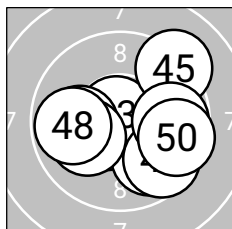
**Serie 5: 99.3** (94)

10.5*↖	9.9↘	10.8*↖	10.0↖	9.2↗
9.6↘	10.1↖	9.8↖	9.8↗	9.6↗

beste Teiler: 45.7 (43.), 105.2 (41.), 213.7 (47.)
 Trefferkreis: 11.49 mm
 Trefferlage: 0.53 mm rechts, 0.37 mm tief

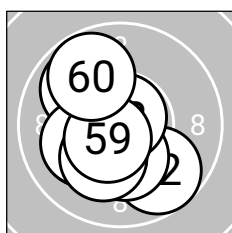
**Serie 6: 102.3** (97)

10.1↖	9.7↘	9.9↖	10.8*↖	10.3*↘
10.1↖	10.2*↖	10.8*↗	10.6*↖	9.8↖

beste Teiler: 26.0 (54.), 41.1 (58.), 96.2 (59.)
 Trefferkreis: 10.40 mm
 Trefferlage: 0.63 mm links, 0.33 mm tief



LG 60 ZR

StandNr: 113

Patka-Rangger,, Patricia #70108009**Frauen**

Wertung

StartNr: 103

31.01.2026 17:55

SG_Mieming

Ergebnis: **618.9** (589)
 Serien: 102.2 105.2 102.7 102.3 102.9 103.6
 Zähler: 49 11 0 0 0 0 0 0 0 0
 Innenzehner: 42
 Weitestе: 446 (5.), 356 (50.), 353 (32.)
 beste Teiler: 23.6 (37.), 35.0 (18.), 48.0 (36.)
 Trefferkreis: 12.40 mm
 Trefferlage: 0.23 mm links, 0.28 mm hoch

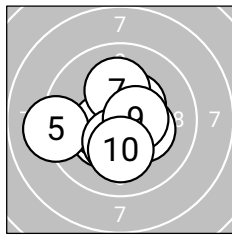
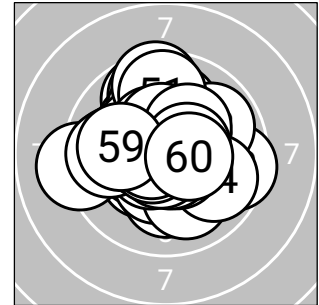
**Serie 1: 102.2** (99)

10.3*↘	10.5*↑	10.3*↙	10.5*↖	9.2←
10.4*↗	10.1↑	10.3*↓	10.5*→	10.1↓

beste Teiler: 105.1 (9.), 107.6 (2.), 121.4 (4.)
 Trefferkreis: 10.45 mm
 Trefferlage: 0.36 mm links, 0.22 mm tief

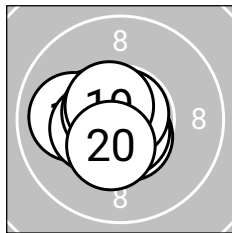
**Serie 2: 105.2** (100)

10.4*←	10.0←	10.7*↓	10.4*←	10.6*↘
10.7*↘	10.6*←	10.8*↗	10.6*↖	10.4*↓

beste Teiler: 35.0 (18.), 66.3 (16.), 67.1 (13.)
 Trefferkreis: 7.48 mm
 Trefferlage: 0.58 mm links, 0.21 mm tief

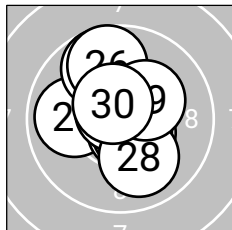
**Serie 3: 102.7** (97)

9.9←	10.6*↘	10.5*↘	10.6*↘	9.7↗
9.7↗	10.8*↖	10.0↓	10.3*↗	10.6*↖

beste Teiler: 50.2 (27.), 78.0 (22.), 94.7 (24.)
 Trefferkreis: 9.93 mm
 Trefferlage: 0.07 mm links, 0.40 mm hoch

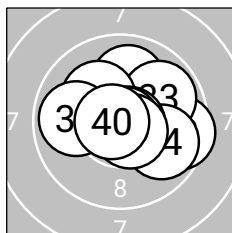
**Serie 4: 102.3** (96)

10.0↑	9.5→	9.9↗	9.8↘	10.2*↖
10.8*→	10.9*↘	9.9←	10.6*↘	10.7*←

beste Teiler: 23.6 (37.), 48.0 (36.), 51.0 (40.)
 Trefferkreis: 10.69 mm
 Trefferlage: 0.55 mm rechts, 0.26 mm hoch

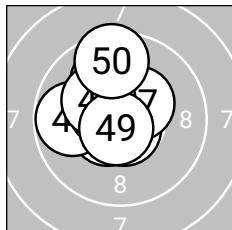
**Serie 5: 102.9** (98)

10.6*↙	10.5*↖	9.8←	10.5*↖	10.0↗
10.7*↘	10.4*↗	10.2*↖	10.7*↘	9.5↑

beste Teiler: 59.5 (49.), 62.3 (46.), 96.4 (41.)
 Trefferkreis: 9.05 mm
 Trefferlage: 0.71 mm links, 0.75 mm hoch

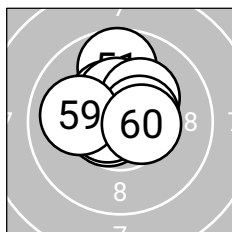
**Serie 6: 103.6** (99)

9.7↑	10.5*←	10.4*↖	10.7*←	10.4*↑
10.7*←	10.2*↗	10.5*→	10.0←	10.5*→

beste Teiler: 72.1 (56.), 74.0 (54.), 110.0 (52.)
 Trefferkreis: 8.54 mm
 Trefferlage: 0.25 mm links, 0.73 mm hoch

