

Ergebnis: **418.3** (399)
Serien: 104.1 103.8 105.5 104.9
Zähler: 39 1 0 0 0 0 0 0 0 0
Innenzehner: 35
Weiteste: 286 (21.), 248 (1.), 237 (16.)
beste Teiler: 24.4 (30.), 26.9 (23.), 38.0 (27.)
Trefferkreis: 9.47 mm
Trefferlage: 0.08 mm rechts, 0.09 mm tief

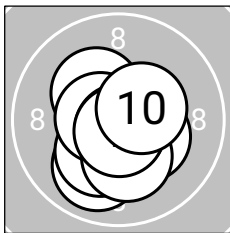
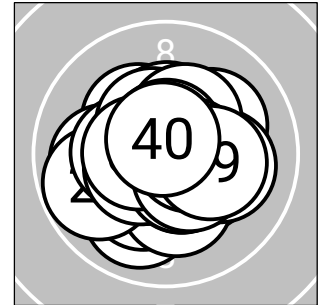

Serie 1: 104.1 (100)

10.0 ↘	10.6* ↘	10.3* ↗	10.2* ↘	10.6* ←
10.3* ↘	10.2* ↘	10.8* ↘	10.7* ↘	10.4* ↗

beste Teiler: 48.8 (8.), 57.2 (9.), 89.4 (2.)
Trefferkreis: 8.29 mm
Trefferlage: 0.10 mm links, 0.63 mm tief

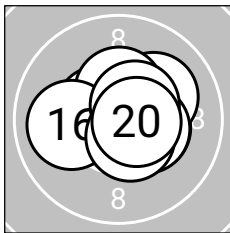

Serie 2: 103.8 (100)

10.5* ←	10.4* ↗	10.4* ↘	10.1 ↗	10.4* ↑
10.0 ←	10.4* ↘	10.5* ↘	10.5* ↗	10.6* ↘

beste Teiler: 92.9 (20.), 105.1 (11.), 106.2 (18.)
Trefferkreis: 8.87 mm
Trefferlage: 0.42 mm rechts, 0.26 mm hoch

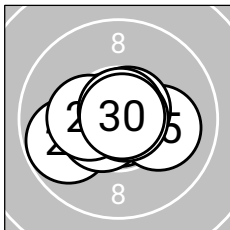

Serie 3: 105.5 (99)

9.8 ←	10.7* ←	10.8* ↘	10.6* ↘	10.1 ↘
10.7* ↗	10.8* ↗	10.3* ←	10.8* ↑	10.9* ↗

beste Teiler: 24.4 (30.), 26.9 (23.), 38.0 (27.)
Trefferkreis: 9.30 mm
Trefferlage: 0.22 mm links, 0.11 mm tief

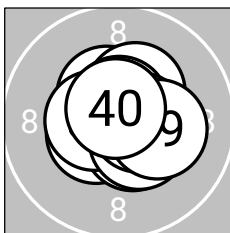

Serie 4: 104.9 (100)

10.5* ←	10.5* ↘	10.4* ↗	10.3* ↗	10.7* ↑
10.5* ←	10.5* ↘	10.6* ↗	10.2* ↘	10.7* ↑

beste Teiler: 60.2 (40.), 70.1 (35.), 96.0 (38.)
Trefferkreis: 7.41 mm
Trefferlage: 0.23 mm rechts, 0.12 mm hoch



Ergebnis: 416.2 (398)
Serien: 103.0 103.7 105.3 104.2
Zähler: 38 2 0 0 0 0 0 0 0 0
Innenzehner: 34
Weiteste: 359 (16.), 265 (3.), 247 (4.)
beste Teiler: 23.0 (20.), 51.9 (19.), 52.5 (7.)
Trefferkreis: 9.85 mm
Trefferlage: 0.53 mm links, 0.12 mm hoch

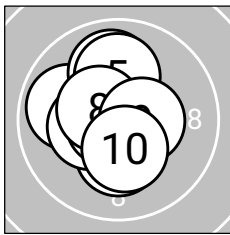
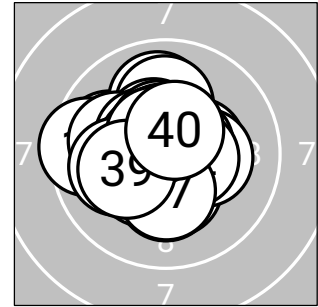

Serie 1: 103.0 (99)

10.5*↖	10.3*↓	9.9↖	10.0↑	10.0↑
10.3*↖	10.7*↖	10.5*↖	10.5*→	10.3*↓

beste Teiler: 52.5 (7.), 112.8 (8.), 123.1 (1.)
Trefferkreis: 8.75 mm
Trefferlage: 0.55 mm links, 0.25 mm hoch

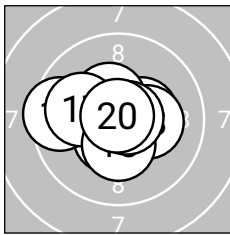

Serie 2: 103.7 (99)

10.5*↙	10.4*→	10.3*→	10.7*↖	10.4*↖
9.5↖	10.0↖	10.3*↓	10.7*→	10.9*↖

beste Teiler: 23.0 (20.), 51.9 (19.), 66.6 (14.)
Trefferkreis: 9.85 mm
Trefferlage: 0.37 mm links, 0.05 mm hoch

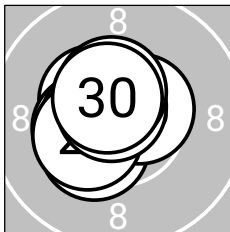

Serie 3: 105.3 (100)

10.4*↖	10.4*↖	10.6*↖	10.7*↑	10.4*↖
10.6*→	10.4*↖	10.7*↖	10.5*↑	10.6*↖

beste Teiler: 58.0 (24.), 58.1 (28.), 91.0 (23.)
Trefferkreis: 6.94 mm
Trefferlage: 0.55 mm links, 0.21 mm hoch

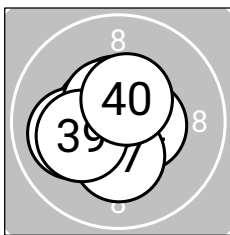

Serie 4: 104.2 (100)

10.6*↖	10.5*→	10.6*↑	10.2*↖	10.7*↖
10.0↖	10.3*↓	10.6*↖	10.2*↖	10.5*↑

beste Teiler: 72.5 (35.), 93.0 (31.), 96.8 (38.)
Trefferkreis: 7.85 mm
Trefferlage: 0.64 mm links, 0.01 mm tief



Ergebnis: 413.5 (396)
Serien: 103.1 102.0 104.2 104.2
Zähler: 36 4 0 0 0 0 0 0 0 0
Innenzehner: 30
Weiteste: 344 (1.), 325 (17.), 279 (3.)
beste Teiler: 8.5 (27.), 35.0 (33.), 51.7 (35.)
Trefferkreis: 11.12 mm
Trefferlage: 0.22 mm links, 0.01 mm tief

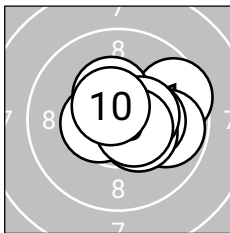
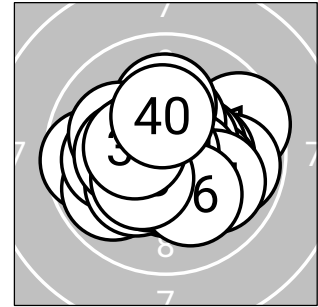

Serie 1: 103.1 (98)

9.6➔	10.6*↑	9.8➔	10.3*➔	10.4*↑
10.4*➔	10.5*←	10.4*➔	10.5*➔	10.6*↑

beste Teiler: 80.2 (2.), 89.5 (10.), 101.5 (9.)
Trefferkreis: 9.05 mm
Trefferlage: 0.90 mm rechts, 0.25 mm hoch

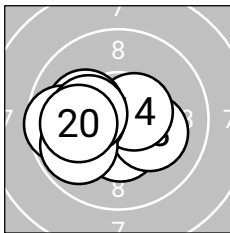

Serie 2: 102.0 (98)

10.7*↘	10.4*↓	10.2*➔	10.5*➔	10.1←
10.2*←	9.7←	9.9←	10.3*←	10.0←

beste Teiler: 60.2 (11.), 101.9 (14.), 137.5 (12.)
Trefferkreis: 9.57 mm
Trefferlage: 1.01 mm links, 0.32 mm tief

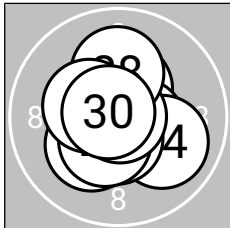

Serie 3: 104.2 (100)

10.2*↙	10.4*↑	10.5*➔	10.0➔	10.6*↓
10.4*↙	10.9*➔	10.1↑	10.4*←	10.7*←

beste Teiler: 8.5 (27.), 53.2 (30.), 100.4 (25.)
Trefferkreis: 8.76 mm
Trefferlage: 0.04 mm links, 0.07 mm tief

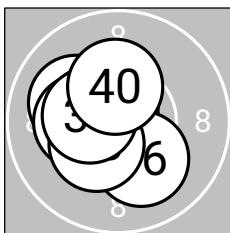

Serie 4: 104.2 (100)

10.1←	10.5*←	10.8*←	10.7*↖	10.7*↙
10.1↘	10.2*←	10.4*↙	10.4*←	10.3*↑

beste Teiler: 35.0 (33.), 51.7 (35.), 69.6 (34.)
Trefferkreis: 8.57 mm
Trefferlage: 0.73 mm links, 0.07 mm hoch



Ergebnis: 415.9 (397)
Serien: 103.6 103.0 104.8 104.5
Zähler: 37 3 0 0 0 0 0 0 0 0
Innenzehner: 35
Weiteste: 361 (22.), 340 (16.), 301 (6.)
beste Teiler: 29.1 (23.), 38.9 (8.), 54.2 (37.)
Trefferkreis: 9.99 mm
Trefferlage: 0.14 mm links, 0.21 mm hoch

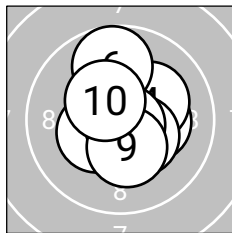
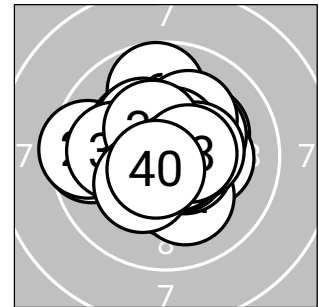

Serie 1: 103.6 (99)

10.5*↙	10.3*→	10.6*↗	10.2*↗	10.4*↘
9.7↑	10.4*↙	10.8*↘	10.3*↓	10.4*↖

beste Teiler: 38.9 (8.), 88.8 (3.), 107.9 (1.)
Trefferkreis: 9.07 mm
Trefferlage: 0.19 mm rechts, 0.18 mm hoch

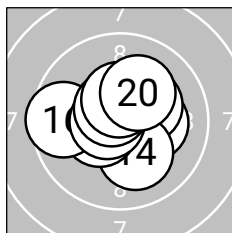

Serie 2: 103.0 (99)

10.2*→	10.6*↗	10.3*↗	10.1↓	10.4*↙
9.6←	10.6*←	10.6*↖	10.4*↑	10.2*↗

beste Teiler: 78.0 (17.), 92.0 (18.), 98.4 (12.)
Trefferkreis: 9.71 mm
Trefferlage: 0.04 mm links, 0.33 mm hoch

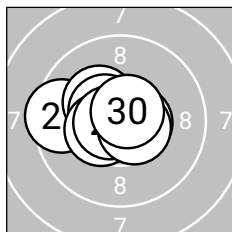

Serie 3: 104.8 (99)

10.6*→	9.5←	10.8*↗	10.7*↖	10.3*↖
10.5*↖	10.4*↙	10.7*←	10.6*↗	10.7*↗

beste Teiler: 29.1 (23.), 61.8 (24.), 64.7 (28.)
Trefferkreis: 9.07 mm
Trefferlage: 0.56 mm links, 0.18 mm hoch

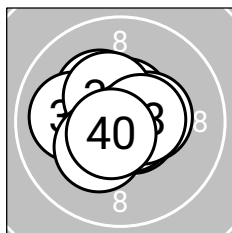

Serie 4: 104.5 (100)

10.7*↘	10.6*↗	10.3*↖	10.4*→	10.0←
10.4*↖	10.7*↘	10.5*→	10.3*↙	10.6*↙

beste Teiler: 54.2 (37.), 69.4 (31.), 76.4 (40.)
Trefferkreis: 8.18 mm
Trefferlage: 0.17 mm links, 0.15 mm hoch



Ergebnis: 415.9 (396)
Serien: 102.1 103.8 104.9 105.1
Zähler: 37 2 1 0 0 0 0 0 0 0
Innenzehner: 35
Weiteste: 527 (9.), 374 (12.), 262 (5.)
beste Teiler: 2.2 (4.), 18.6 (33.), 37.3 (20.)
Trefferkreis: 12.26 mm
Trefferlage: 0.17 mm links, 0.16 mm tief

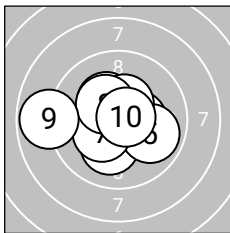
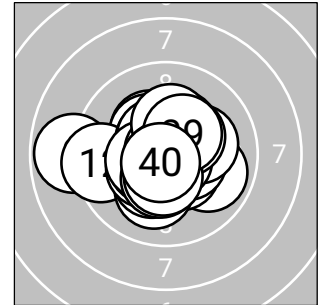

Serie 1: 102.1 (97)

10.1↓	10.4*→	10.3*↖	10.9*↖	9.9↘
10.4*↗	10.3*↖	10.3*↖	8.8←	10.7*↗

beste Teiler: 2.2 (4.), 61.3 (10.), 128.1 (6.)
Trefferkreis: 12.26 mm
Trefferlage: 0.42 mm links, 0.00 mm

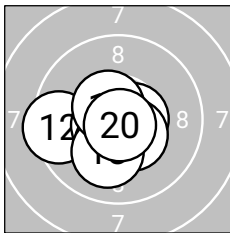

Serie 2: 103.8 (99)

10.5*↖	9.5←	10.6*→	10.6*↖	10.5*↘
10.3*↘	10.4*↘	10.1↓	10.5*↖	10.8*↓

beste Teiler: 37.3 (20.), 78.7 (14.), 89.0 (13.)
Trefferkreis: 9.13 mm
Trefferlage: 0.45 mm links, 0.66 mm tief

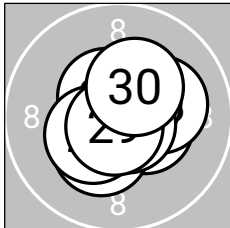

Serie 3: 104.9 (100)

10.7*↗	10.4*↗	10.2*→	10.5*↖	10.6*↗
10.3*↘	10.4*↖	10.7*↘	10.8*↘	10.3*↗

beste Teiler: 47.5 (29.), 52.4 (28.), 58.8 (21.)
Trefferkreis: 7.85 mm
Trefferlage: 0.27 mm rechts, 0.04 mm hoch

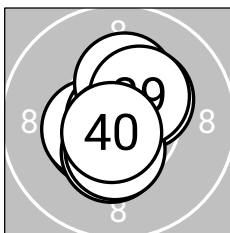

Serie 4: 105.1 (100)

10.5*↖	10.5*↖	10.9*↖	10.4*↓	10.2*↑
10.8*↘	10.3*↗	10.4*↓	10.4*↗	10.7*↘

beste Teiler: 18.6 (33.), 41.6 (36.), 57.4 (40.)
Trefferkreis: 7.68 mm
Trefferlage: 0.08 mm links, 0.04 mm tief



Ergebnis: 415.1 (395)
Serien: 103.7 104.2 104.0 103.2
Zähler: 35 5 0 0 0 0 0 0 0 0
Innenzehner: 30
Weiteste: 452 (29.), 414 (18.), 275 (37.)
beste Teiler: 23.5 (6.), 28.0 (7.), 33.3 (1.)
Trefferkreis: 11.75 mm
Trefferlage: 0.01 mm links, 0.25 mm tief

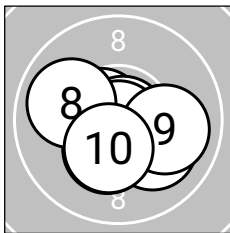
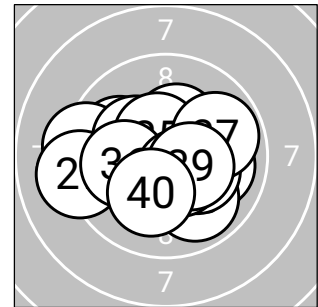

Serie 1: 103.7 (99)

10.8*↓ 10.3*↓ 10.0→ 10.1↘ 10.6*↖
 10.9*→ 10.8*↓ 9.9← 10.0→ 10.3*↓

beste Teiler: 23.5 (6.), 28.0 (7.), 33.3 (1.)
Trefferkreis: 9.40 mm
Trefferlage: 0.23 mm rechts, 0.47 mm tief

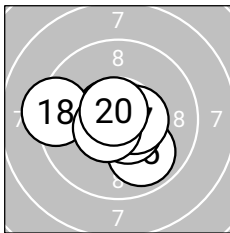

Serie 2: 104.2 (98)

10.5*↘ 10.6*← 10.8*↑ 10.7*↖ 9.9↘
 10.6*↘ 10.5*→ 9.3← 10.6*↖ 10.7*↖

beste Teiler: 34.7 (13.), 60.0 (20.), 68.7 (14.)
Trefferkreis: 10.71 mm
Trefferlage: 0.25 mm links, 0.21 mm tief

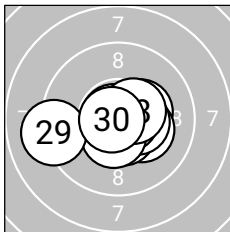

Serie 3: 104.0 (99)

10.8*↖ 10.3*→ 10.3*↘ 10.6*↓ 10.4*→
 10.7*→ 10.5*↓ 10.5*→ 9.1← 10.8*←

beste Teiler: 33.5 (21.), 45.2 (30.), 54.0 (26.)
Trefferkreis: 10.60 mm
Trefferlage: 0.07 mm rechts, 0.28 mm tief

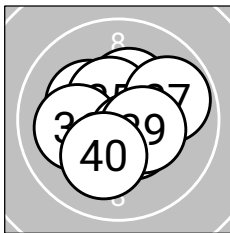

Serie 4: 103.2 (99)

10.5*↖ 10.6*← 10.3*↖ 10.3*↑ 10.5*↖
 10.1← 9.9→ 10.5*↘ 10.4*→ 10.1↓

beste Teiler: 79.6 (32.), 110.1 (35.), 111.6 (38.)
Trefferkreis: 9.41 mm
Trefferlage: 0.12 mm links, 0.05 mm tief



Ergebnis: 409.1 (392)
Serien: 100.7 105.1 103.9 99.4
Zähler: 32 8 0 0 0 0 0 0 0 0
Innenzehner: 26
Weiteste: 496 (32.), 365 (1.), 356 (40.)
beste Teiler: 62.0 (20.), 63.1 (17.), 67.8 (36.)
Trefferkreis: 12.31 mm
Trefferlage: 0.10 mm rechts, 0.49 mm tief

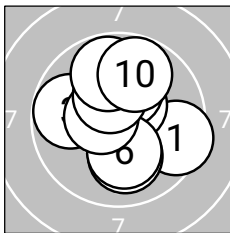
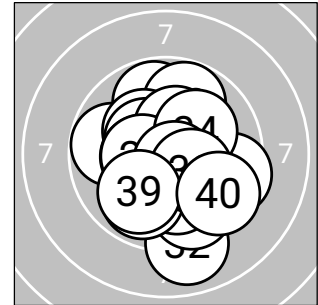

Serie 1: 100.7 (96)

9.5➡	10.5*↗	9.8←	10.2*↗	10.1↓
10.2*↓	10.5*←	10.3*↖	9.8↖	9.8↗

beste Teiler: 104.5 (7.), 112.6 (2.), 152.4 (8.)
Trefferkreis: 11.08 mm
Trefferlage: 0.13 mm rechts, 0.51 mm hoch

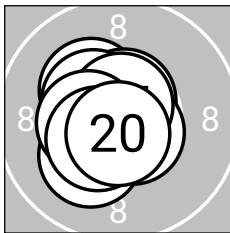

Serie 2: 105.1 (100)

10.7*↓	10.3*↖	10.6*↗	10.6*➡	10.2*↖
10.4*↖	10.7*↗	10.4*←	10.5*↖	10.7*↓

beste Teiler: 62.0 (20.), 63.1 (17.), 68.5 (11.)
Trefferkreis: 7.42 mm
Trefferlage: 0.49 mm links, 0.08 mm tief

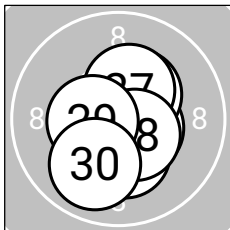

Serie 3: 103.9 (100)

10.5*↓	10.5*➡	10.6*↓	10.3*↓	10.4*↗
10.4*↖	10.3*↗	10.5*➡	10.4*←	10.0↖

beste Teiler: 81.5 (23.), 106.5 (22.), 111.7 (28.)
Trefferkreis: 8.52 mm
Trefferlage: 0.05 mm rechts, 0.53 mm tief

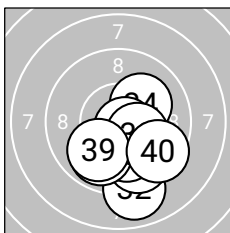

Serie 4: 99.4 (96)

10.1↓	9.0↓	9.7↓	10.1↗	10.1↓
10.7*➡	9.9↖	10.3*➡	10.0↖	9.5➡

beste Teiler: 67.8 (36.), 163.3 (38.), 203.4 (34.)
Trefferkreis: 10.58 mm
Trefferlage: 0.73 mm rechts, 1.84 mm tief



Ergebnis: 409.9 (394)
Serien: 101.6 100.6 103.4 104.3
Zähler: 34 6 0 0 0 0 0 0 0 0
Innenzehner: 27
Weiteste: 496 (15.), 370 (5.), 324 (4.)
beste Teiler: 54.1 (37.), 54.5 (38.), 84.4 (25.)
Trefferkreis: 10.91 mm
Trefferlage: 1.00 mm links, 0.14 mm tief

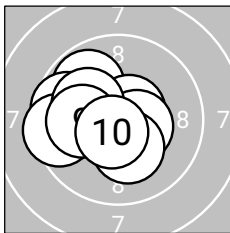
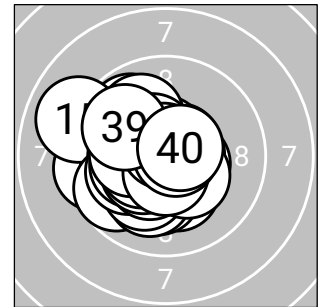

Serie 1: 101.6 (97)

9.8↖	10.6*↗	10.5*↘	9.7↖	9.5↖
10.5*↗	10.1↖	10.2*↘	10.1↖	10.6*↘

beste Teiler: 84.8 (2.), 85.8 (10.), 105.1 (3.)
Trefferkreis: 9.32 mm
Trefferlage: 1.01 mm links, 0.01 mm tief

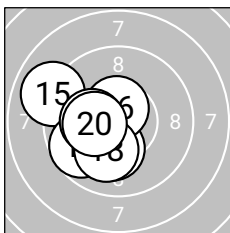

Serie 2: 100.6 (98)

10.2*↓	10.5*↖	10.0↖	10.0↖	9.0↖
10.6*↑	9.7↖	10.1↘	10.2*↖	10.3*↖

beste Teiler: 92.7 (16.), 107.9 (12.), 166.9 (20.)
Trefferkreis: 10.16 mm
Trefferlage: 1.71 mm links, 0.51 mm tief

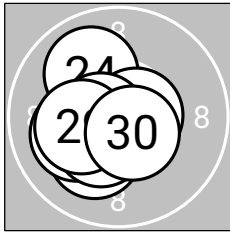

Serie 3: 103.4 (100)

10.4*↖	10.4*↖	10.2*↘	10.0↖	10.6*↗
10.1↖	10.4*↘	10.6*↖	10.2*↖	10.5*↘

beste Teiler: 84.4 (25.), 85.1 (28.), 102.0 (30.)
Trefferkreis: 8.26 mm
Trefferlage: 0.82 mm links, 0.11 mm tief

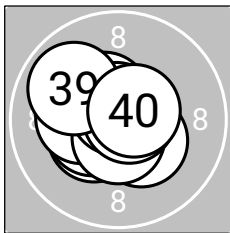

Serie 4: 104.3 (99)

10.4*↖	10.5*↖	10.3*↘	10.4*↖	10.2*↖
10.6*↓	10.7*↑	10.7*↗	9.9↖	10.6*↗

beste Teiler: 54.1 (37.), 54.5 (38.), 87.0 (36.)
Trefferkreis: 8.63 mm
Trefferlage: 0.47 mm links, 0.05 mm hoch

