

Ergebnis: 420.2 (398)
Serien: 104.6 105.1 105.9 104.6
Zähler: 38 2 0 0 0 0 0 0 0 0
Innenzehner: 36
Weiteste: 295 (1.), 258 (17.), 218 (36.)
beste Teiler: 45.8 (18.), 49.0 (4.), 50.9 (31.)
Trefferkreis: 10.03 mm
Trefferlage: 0.06 mm links, 0.12 mm hoch

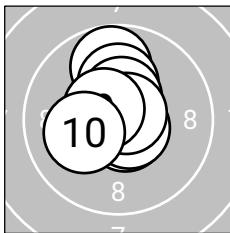
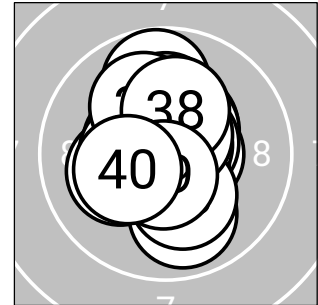

Serie 1: 104.6 (99)

9.8↑	10.2*↑	10.7*↘	10.8*←	10.6*←
10.5*↑	10.6*↘	10.7*↗	10.6*↖	10.1←

beste Teiler: 49.0 (4.), 56.2 (8.), 73.2 (3.)
Trefferkreis: 8.50 mm
Trefferlage: 0.28 mm links, 0.52 mm hoch

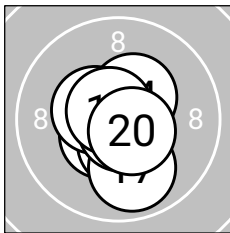

Serie 2: 105.1 (99)

10.7*↓	10.5*↙	10.6*↗	10.4*↗	10.5*↓
10.4*↖	9.9↓	10.8*↘	10.7*↖	10.6*↘

beste Teiler: 45.8 (18.), 57.0 (11.), 61.5 (19.)
Trefferkreis: 8.25 mm
Trefferlage: 0.06 mm rechts, 0.34 mm tief

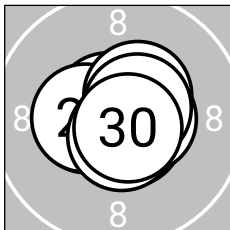

Serie 3: 105.9 (100)

10.7*↗	10.7*↘	10.7*↖	10.6*→	10.4*←
10.4*←	10.4*↗	10.7*↓	10.6*↗	10.7*↘

beste Teiler: 54.4 (30.), 62.2 (21.), 66.7 (23.)
Trefferkreis: 6.92 mm
Trefferlage: 0.09 mm rechts, 0.07 mm hoch

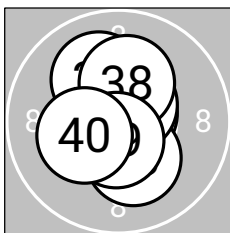

Serie 4: 104.6 (100)

10.8*↗	10.7*↗	10.2*↘	10.6*↖	10.5*↙
10.1↖	10.6*↗	10.2*↑	10.6*↓	10.3*↙

beste Teiler: 50.9 (31.), 65.2 (32.), 87.5 (39.)
Trefferkreis: 8.53 mm
Trefferlage: 0.15 mm links, 0.22 mm hoch



LG 40 ZR

StandNr: 138

Oberhofer,, Ramona #70406023

Frauen

Wertung

StartNr: 135

01.02.2026 13:35

SG_Bruckhäusl

Ergebnis: **410.1 (394)**
 Serien: 102.3 102.1 103.9 101.8
 Zähler: 34 6 0 0 0 0 0 0 0 0
 Innenzehner: 30
 Weitester: 454 (36.), 442 (2.), 442 (11.)
 beste Teiler: 50.2 (27.), 52.7 (5.), 68.2 (6.)
 Trefferkreis: 13.38 mm
 Trefferlage: 0.67 mm links, 0.41 mm tief

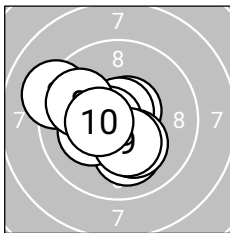
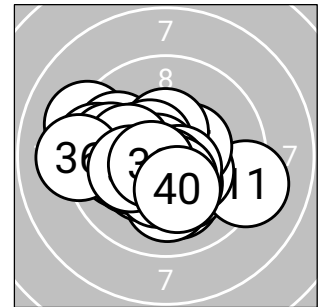

Serie 1: 102.3 (98)

10.1 ↓	9.2 ↙	10.6* ↗	10.2* ↙	10.7* ↑
10.7* ↙	10.2* ↘	9.9 ↖	10.3* ↘	10.4* ↖

beste Teiler: 52.7 (5.), 68.2 (6.), 84.1 (3.)
 Trefferkreis: 10.55 mm
 Trefferlage: 0.74 mm links, 0.21 mm tief

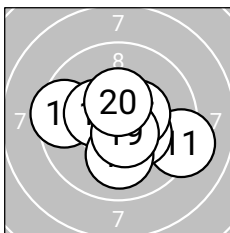

Serie 2: 102.1 (98)

9.2 ↘	9.5 ↖	10.3* ↘	10.6* ↖	10.4* ↗
10.6* ↓	10.4* ↖	10.1 ↓	10.6* ↘	10.4* ↑

beste Teiler: 80.3 (16.), 91.3 (19.), 93.7 (14.)
 Trefferkreis: 12.51 mm
 Trefferlage: 0.15 mm rechts, 0.26 mm tief

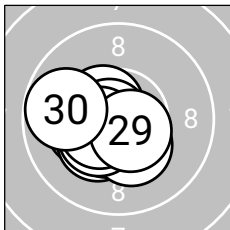

Serie 3: 103.9 (99)

10.5* ↖	10.2* ↖	10.3* ↖	10.5* ↖	10.3* ↘
10.4* ↖	10.8* ↖	10.5* ↖	10.6* ↘	9.8 ↖

beste Teiler: 50.2 (27.), 93.3 (29.), 108.7 (21.)
 Trefferkreis: 8.58 mm
 Trefferlage: 0.83 mm links, 0.48 mm tief

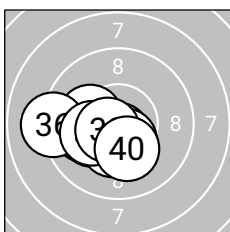

Serie 4: 101.8 (99)

10.0 ↖	10.2* ↖	10.6* ↓	10.1 ↖	10.3* ↓
9.1 ↖	10.5* ↘	10.2* ↖	10.6* ↖	10.2* ↘

beste Teiler: 79.0 (33.), 86.9 (39.), 125.9 (37.)
 Trefferkreis: 9.90 mm
 Trefferlage: 1.25 mm links, 0.71 mm tief



Ergebnis: **413.3** (398)
 Serien: 103.5 104.3 103.8 101.7
 Zähler: 38 2 0 0 0 0 0 0 0 0
 Innenzehner: 33
 Weitester: 362 (33.), 273 (39.), 245 (37.)
 beste Teiler: 16.2 (7.), 62.2 (23.), 62.8 (16.)
 Trefferkreis: 10.39 mm
 Trefferlage: 0.24 mm rechts, 0.11 mm tief

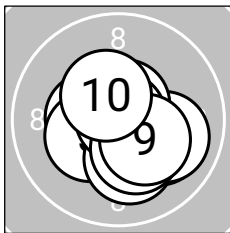
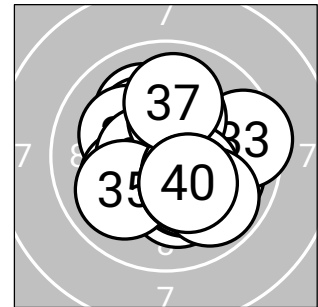

Serie 1: 103.5 (100)

10.1 ↘	10.4* ←	10.3* ←	10.2* ↓	10.0 ↘
10.6* ↗	10.9* ↗	10.3* ↓	10.3* ↘	10.4* ↗

beste Teiler: 16.2 (7.), 78.9 (6.), 133.7 (10.)
 Trefferkreis: 8.25 mm
 Trefferlage: 0.40 mm rechts, 0.48 mm tief

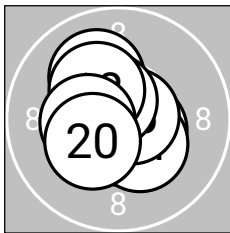

Serie 2: 104.3 (100)

10.6* ↓	10.5* ↘	10.5* ←	10.3* ↘	10.1 ↗
10.7* →	10.6* ↗	10.3* ↗	10.4* ←	10.3* ↗

beste Teiler: 62.8 (16.), 96.5 (11.), 98.4 (17.)
 Trefferkreis: 8.23 mm
 Trefferlage: 0.31 mm links, 0.07 mm hoch

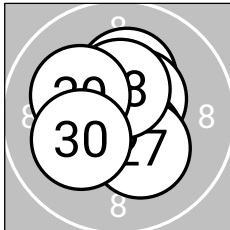

Serie 3: 103.8 (100)

10.4* ↑	10.4* ↓	10.7* ↓	10.2* ↑	10.5* ↗
10.5* ↓	10.3* ↓	10.4* ↑	10.2* ↗	10.2* ↗

beste Teiler: 62.2 (23.), 116.6 (25.), 117.4 (26.)
 Trefferkreis: 8.17 mm
 Trefferlage: 0.10 mm rechts, 0.12 mm hoch

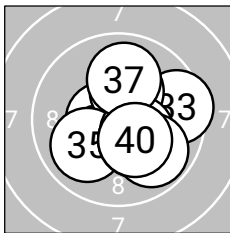

Serie 4: 101.7 (98)

10.6* ←	10.5* →	9.5 →	10.2* ↑	10.0 ↗
10.4* ↘	10.0 ↑	10.3* ↓	9.9 ↘	10.3* ↓

beste Teiler: 94.0 (31.), 102.1 (32.), 136.7 (36.)
 Trefferkreis: 10.39 mm
 Trefferlage: 0.77 mm rechts, 0.16 mm tief



LG 40 ZR

StandNr: 140

Walch,, Alexander #70108267

Senioren_1m

Wertung

StartNr: 137

01.02.2026 13:34

SG_Mieming

Ergebnis: **420.7 (399)**
 Serien: 106.3 103.3 105.3 105.8
 Zähler: 39 1 0 0 0 0 0 0 0 0
 Innenzehner: 36
 Weitester: 330 (15.), 238 (27.), 213 (12.)
 beste Teiler: 9.8 (29.), 10.7 (24.), 12.3 (1.)
 Trefferkreis: 9.74 mm
 Trefferlage: 0.09 mm links, 0.05 mm hoch

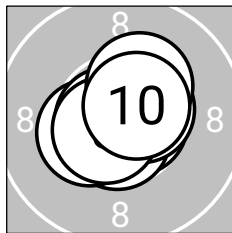
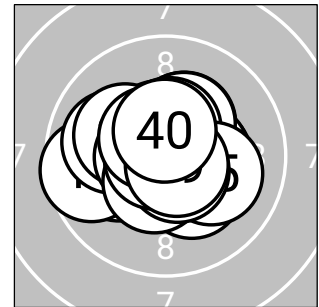
**Serie 1: 106.3 (100)**

10.9*↑	10.7*→	10.7*↗	10.7*↓	10.4*↖
10.6*↗	10.7*↖	10.7*↖	10.3*↗	10.6*↗

beste Teiler: 12.3 (1.), 51.0 (7.), 60.8 (2.)
 Trefferkreis: 7.37 mm
 Trefferlage: 0.09 mm rechts, 0.13 mm hoch

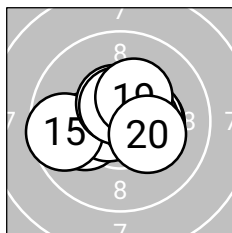
**Serie 2: 103.3 (99)**

10.3*→	10.1↖	10.4*→	10.7*↖	9.6↖
10.5*→	10.5*↑	10.6*↑	10.3*↗	10.3*↗

beste Teiler: 69.4 (14.), 92.2 (18.), 109.1 (17.)
 Trefferkreis: 9.36 mm
 Trefferlage: 0.00 mm, 0.13 mm hoch

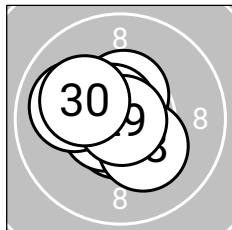
**Serie 3: 105.3 (100)**

10.5*↑	10.6*↖	10.7*↓	10.9*↘	10.6*↖
10.7*↖	10.0↖	10.2*↘	10.9*↘	10.2*↖

beste Teiler: 9.8 (29.), 10.7 (24.), 65.8 (26.)
 Trefferkreis: 8.46 mm
 Trefferlage: 0.47 mm links, 0.05 mm hoch

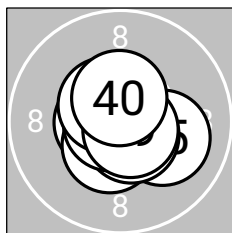
**Serie 4: 105.8 (100)**

10.6*↖	10.8*↓	10.5*↓	10.7*↑	10.1↗
10.6*↘	10.8*↖	10.5*↖	10.7*↘	10.5*↑

beste Teiler: 44.7 (37.), 45.6 (32.), 54.7 (34.)
 Trefferkreis: 7.59 mm
 Trefferlage: 0.01 mm rechts, 0.10 mm tief

Ergebnis: **418.8** (399)
 Serien: 103.7 105.1 105.1 104.9
 Zähler: 39 1 0 0 0 0 0 0 0 0
 Innenzehner: 34
 Weitester: 282 (36.), 242 (33.), 226 (4.)
 beste Teiler: 13.0 (31.), 28.4 (20.), 32.2 (21.)
 Trefferkreis: 9.75 mm
 Trefferlage: 0.14 mm links, 0.06 mm tief

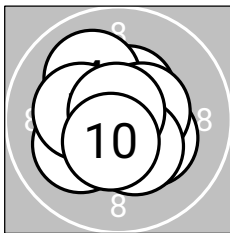
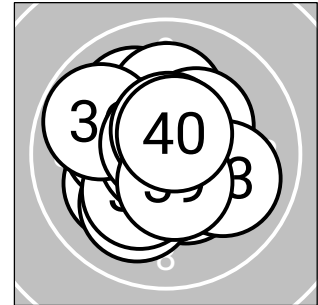

Serie 1: 103.7 (100)

10.5*↘	10.3*↘	10.4*↑	10.0↖	10.5*→
10.1↙	10.2*←	10.4*↘	10.8*↑	10.5*↓

beste Teiler: 39.0 (9.), 102.8 (1.), 107.8 (10.)
 Trefferkreis: 8.47 mm
 Trefferlage: 0.05 mm links, 0.06 mm tief

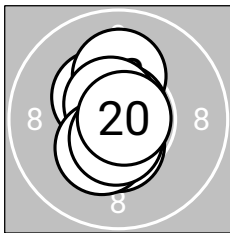

Serie 2: 105.1 (100)

10.4*↑	10.4*↖	10.1↑	10.8*↑	10.6*↖
10.6*↓	10.5*↓	10.3*↘	10.6*↓	10.8*→

beste Teiler: 28.4 (20.), 42.7 (14.), 82.7 (15.)
 Trefferkreis: 8.04 mm
 Trefferlage: 0.23 mm links, 0.13 mm hoch

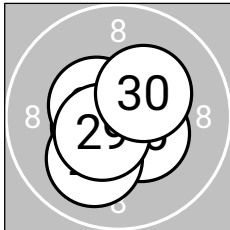

Serie 3: 105.1 (100)

10.8*→	10.6*↘	10.6*↖	10.7*↖	10.6*↖
10.4*↘	10.1↙	10.5*↖	10.5*↖	10.3*↘

beste Teiler: 32.2 (21.), 61.8 (24.), 97.5 (23.)
 Trefferkreis: 8.31 mm
 Trefferlage: 0.16 mm links, 0.39 mm tief

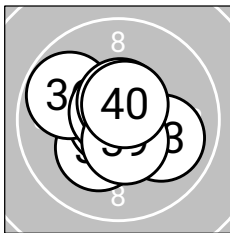

Serie 4: 104.9 (99)

10.9*↑	10.2*↘	10.0↘	10.8*↖	10.7*↑
9.8↖	10.8*↖	10.6*↑	10.5*↓	10.6*↑

beste Teiler: 13.0 (31.), 35.9 (34.), 49.8 (37.)
 Trefferkreis: 9.75 mm
 Trefferlage: 0.13 mm links, 0.05 mm hoch



LG 40 ZR

StandNr: 143

Pfurtscheller, Barbara #70818822

Senioren_1w

Wertung

StartNr: 139

01.02.2026 13:37

SG_Fulpmes

Ergebnis: **421.5 (400)**
 Serien: 105.3 105.2 105.4 105.6
 Zähler: 40 0 0 0 0 0 0 0 0 0 0
 Innenzehner: 39
 Weitester: 220 (11.), 187 (12.), 168 (21.)
 beste Teiler: 41.1 (38.), 47.7 (20.), 51.0 (18.)
 Trefferkreis: 8.37 mm
 Trefferlage: 0.31 mm links, 0.29 mm hoch

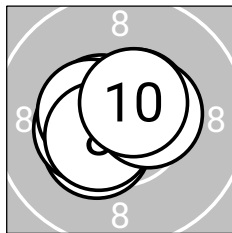
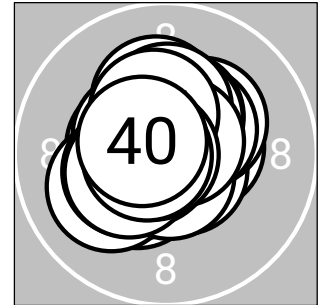
**Serie 1: 105.3 (100)**

10.7*↖	10.4*↙	10.6*↗	10.5*↖	10.6*↖
10.4*↖	10.5*↖	10.5*↖	10.5*↗	10.6*↗

beste Teiler: 67.7 (1.), 89.8 (10.), 90.0 (5.)
 Trefferkreis: 7.11 mm
 Trefferlage: 0.44 mm links, 0.01 mm hoch

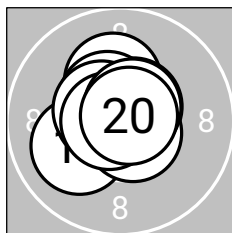
**Serie 2: 105.2 (100)**

10.1↙	10.2*↑	10.6*↖	10.6*↗	10.5*↖
10.6*↘	10.5*↖	10.7*↖	10.6*↗	10.8*↗

beste Teiler: 47.7 (20.), 51.0 (18.), 79.9 (16.)
 Trefferkreis: 7.88 mm
 Trefferlage: 0.28 mm links, 0.36 mm hoch

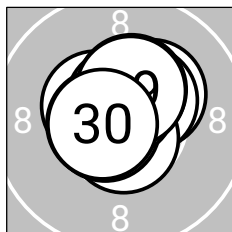
**Serie 3: 105.4 (100)**

10.3*↗	10.5*↖	10.5*↗	10.4*↗	10.7*↓
10.7*↖	10.6*↑	10.6*↖	10.4*↗	10.7*↖

beste Teiler: 65.7 (26.), 71.3 (25.), 74.1 (30.)
 Trefferkreis: 6.92 mm
 Trefferlage: 0.01 mm rechts, 0.47 mm hoch

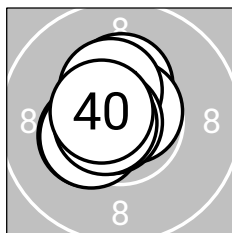
**Serie 4: 105.6 (100)**

10.7*↖	10.4*↖	10.3*↑	10.7*↗	10.4*↑
10.6*↖	10.4*↖	10.8*↖	10.7*↖	10.6*↖

beste Teiler: 41.1 (38.), 64.3 (34.), 65.2 (39.)
 Trefferkreis: 7.11 mm
 Trefferlage: 0.55 mm links, 0.31 mm hoch