

Ergebnis: **196.3** (187)
 Serien: 97.3 99.0
 Zähler: 10 7 3 0 0 0 0 0 0 0 0
 Innenzehner: 7
 Weitester: 623 (5.), 512 (13.), 505 (20.)
 beste Teiler: 75.8 (11.), 83.0 (1.), 114.1 (15.)
 Trefferkreis: 14.94 mm
 Trefferlage: 1.07 mm rechts, 0.81 mm tief

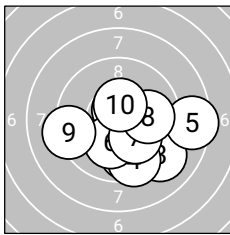
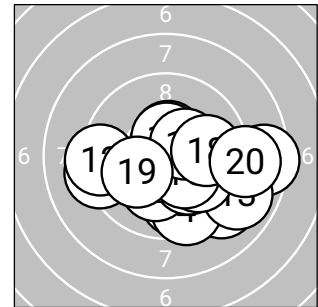

Serie 1: 97.3 (93)

10.6*↑	9.8↓	9.1↘	9.5↓	8.5→
10.2*↓	10.1↘	9.9→	9.2←	10.4*↑

beste Teiler: 83.0 (1.), 126.0 (10.), 198.9 (6.)
 Trefferkreis: 14.94 mm
 Trefferlage: 1.10 mm rechts, 1.15 mm tief

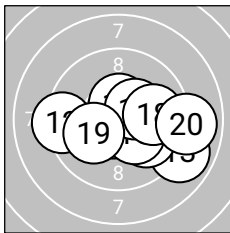

Serie 2: 99.0 (94)

10.7*↓	9.3←	8.9↘	10.0↘	10.5*↑
10.3*↘	10.4*↗	9.9→	10.1←	8.9→

beste Teiler: 75.8 (11.), 114.1 (15.), 144.5 (17.)
 Trefferkreis: 13.69 mm
 Trefferlage: 1.03 mm rechts, 0.48 mm tief



Ergebnis: **191.3 (180)**
 Serien: 94.0 97.3
 Zähler: 7 7 5 1 0 0 0 0 0 0
 Innenzehner: 5
 Weitester: 786 (6.), 697 (13.), 642 (20.)
 beste Teiler: 45.2 (19.), 59.0 (14.), 65.7 (5.)
 Trefferkreis: 18.89 mm
 Trefferlage: 0.07 mm links, 0.66 mm hoch

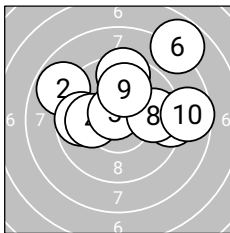
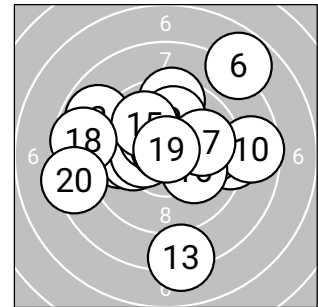

Serie 1: 94.0 (88)

9.2→ 8.8↖ 9.7← 10.1← 10.7*↖
 7.8↗ 9.4↑ 9.8→ 9.9↑ 8.6→

beste Teiler: 65.7 (5.), 220.1 (4.), 254.1 (9.)
 Trefferkreis: 15.32 mm
 Trefferlage: 0.87 mm rechts, 1.63 mm hoch

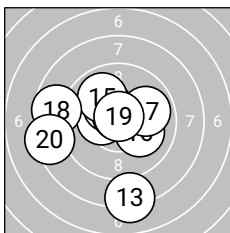

Serie 2: 97.3 (92)

10.3*← 10.3*↖ 8.2↓ 10.7*↑ 9.9↖
 10.1→ 9.9→ 8.7← 10.8*↑ 8.4←

beste Teiler: 45.2 (19.), 59.0 (14.), 151.4 (11.)
 Trefferkreis: 14.99 mm
 Trefferlage: 1.03 mm links, 0.29 mm tief



Ergebnis: 196.5 (187)
Serien: 97.5 99.0
Zähler: 11 5 4 0 0 0 0 0 0 0 0
Innenzehner: 10
Weiteste: 680 (9.), 670 (7.), 531 (15.)
beste Teiler: 44.5 (10.), 60.4 (5.), 104.9 (20.)
Trefferkreis: 17.97 mm
Trefferlage: 0.33 mm rechts, 0.11 mm tief

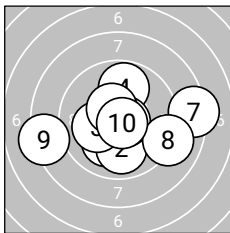
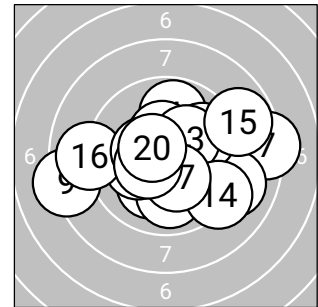

Serie 1: 97.5 (93)

10.1 ↘	9.9 ↓	10.2* ←	9.8 ↑	10.7* →
10.5* ↖	8.3 →	9.0 →	8.2 ←	10.8* ↘

beste Teiler: 44.5 (10.), 60.4 (5.), 112.5 (6.)
Trefferkreis: 17.97 mm
Trefferlage: 0.27 mm rechts, 0.46 mm tief

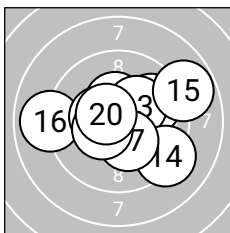

Serie 2: 99.0 (94)

9.9 →	10.4* ↑	10.2* ↗	9.2 ↘	8.8 →
8.9 ←	10.3* ↘	10.4* ←	10.4* ←	10.5* ↖

beste Teiler: 104.9 (20.), 131.0 (19.), 143.0 (12.)
Trefferkreis: 14.61 mm
Trefferlage: 0.40 mm rechts, 0.23 mm hoch



Ergebnis: 171.4 (162)
Serien: 81.1 90.3
Zähler: 1 8 10 0 0 0 0 0 0 0 1
Innenzehner: 1
Weiteste: 2544 (1.), 709 (5.), 685 (14.)
beste Teiler: 106.8 (3.), 252.9 (20.), 283.9 (13.)
Trefferkreis: 35.20 mm
Trefferlage: 3.12 mm rechts, 0.12 mm hoch

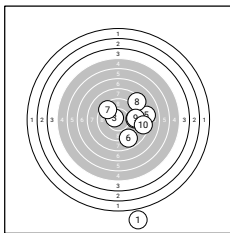
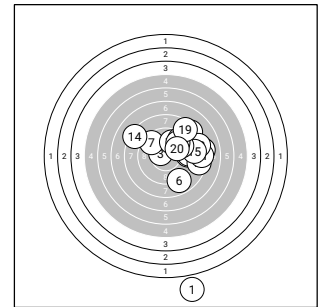

Serie 1: 81.1 (77)

0.0 ↓	8.8 →	10.5* ←	9.3 →	8.1 →
8.9 ↓	9.5 ←	8.4 ↗	9.2 →	8.4 →

beste Teiler: 106.8 (3.), 366.4 (7.), 414.4 (4.)
Trefferkreis: 33.96 mm
Trefferlage: 3.54 mm rechts, 2.06 mm tief

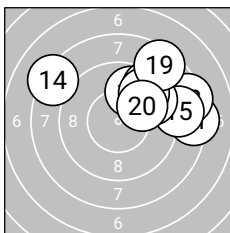

Serie 2: 90.3 (85)

8.3 →	8.4 →	9.8 ↗	8.2 ←	8.8 →
9.3 ↗	9.5 ↗	9.6 ↗	8.5 ↗	9.9 ↗

beste Teiler: 252.9 (20.), 283.9 (13.), 336.9 (18.)
Trefferkreis: 17.50 mm
Trefferlage: 2.71 mm rechts, 2.31 mm hoch



Ergebnis: 374.4 (355)
Serien: 94.5 93.3 91.2 95.4
Zähler: 12 15 10 2 1 0 0 0 0 0 0
Innenzehner: 8
Weiteste: 1185 (31.), 995 (23.), 900 (21.)
beste Teiler: 66.9 (39.), 92.6 (4.), 113.4 (13.)
Trefferkreis: 25.73 mm
Trefferlage: 0.68 mm rechts, 0.34 mm hoch

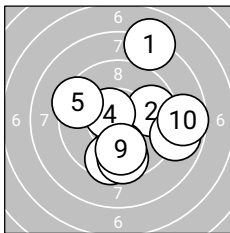
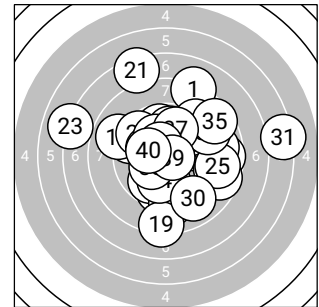

Serie 1: 94.5 (89)

8.1 ↗ 9.8 → 10.0 ↓ 10.6* ↖ 9.4 ↖
 9.5 ↓ 9.6 ↓ 8.9 → 9.9 ↓ 8.7 →

beste Teiler: 92.6 (4.), 240.2 (3.), 261.0 (9.)
Trefferkreis: 15.17 mm
Trefferlage: 1.20 mm rechts, 0.37 mm tief

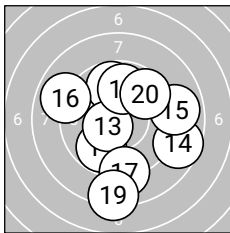

Serie 2: 93.3 (87)

9.8 ↘ 9.8 ↑ 10.5* ↖ 8.6 → 8.9 →
 8.9 ↖ 9.1 ↓ 9.9 ↑ 8.2 ↓ 9.6 ↗

beste Teiler: 113.4 (13.), 274.9 (18.), 290.5 (11.)
Trefferkreis: 15.67 mm
Trefferlage: 0.54 mm rechts, 0.60 mm tief

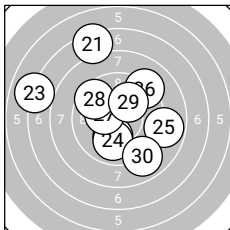

Serie 3: 91.2 (87)

7.4 ↗ 10.1 ↓ 7.0 ↖ 9.9 ↓ 8.9 →
 9.1 ↗ 10.3* ↖ 9.5 ↖ 10.1 ↗ 8.9 ↘

beste Teiler: 165.0 (27.), 205.5 (22.), 221.5 (29.)
Trefferkreis: 19.68 mm
Trefferlage: 0.59 mm links, 0.99 mm hoch

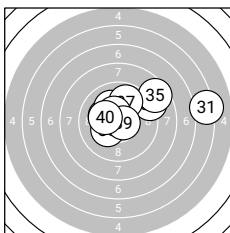

Serie 4: 95.4 (92)

6.2 → 10.2* ↖ 10.2* ↖ 9.0 → 8.6 ↗
 10.1 ↖ 9.8 ↗ 10.4* ↖ 10.7* → 10.2* ↖

beste Teiler: 66.9 (39.), 126.5 (38.), 177.0 (33.)
Trefferkreis: 18.00 mm
Trefferlage: 1.59 mm rechts, 1.34 mm hoch



LG 40 ZR

StandNr: 115

Coser,, Riccardo #70222069

Jungschützen

Wertung

StartNr: 113

01.02.2026 13:50

SG_Oberperfuß

Ergebnis: **397.6 (381)**
 Serien: 100.5 98.2 100.3 98.6
 Zähler: 21 19 0 0 0 0 0 0 0 0
 Innenzehner: 14
 Weitester: 499 (6.), 484 (39.), 467 (31.)
 beste Teiler: 9.2 (32.), 39.8 (15.), 72.6 (29.)
 Trefferkreis: 14.17 mm
 Trefferlage: 0.41 mm rechts, 0.22 mm hoch

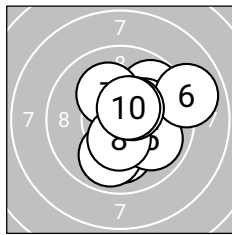
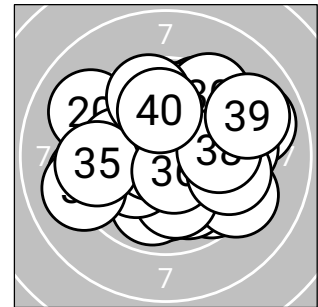

Serie 1: 100.5 (96)

10.1↓	9.8↗	9.9↓	10.2*↗	9.9↘
9.0↗	10.2*↖	10.4*↓	10.5*↗	10.5*↗

beste Teiler: 102.0 (10.), 116.0 (9.), 136.2 (8.)
 Trefferkreis: 11.35 mm
 Trefferlage: 1.04 mm rechts, 0.04 mm hoch

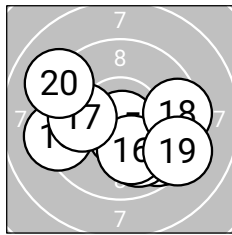

Serie 2: 98.2 (95)

9.7↘	10.6*↓	9.3←	10.0↘	10.8*↓
10.1↓	10.0←	9.4↗	9.2↘	9.1↖

beste Teiler: 39.8 (15.), 86.3 (12.), 211.6 (16.)
 Trefferkreis: 13.42 mm
 Trefferlage: 0.14 mm rechts, 0.77 mm tief

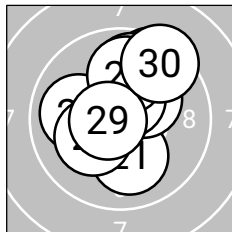

Serie 3: 100.3 (96)

10.1↓	10.0←	9.5↗	10.2*↗	9.8↑
10.5*↗	10.2*↖	9.9↑	10.7*←	9.4↗

beste Teiler: 72.6 (29.), 123.9 (26.), 176.4 (24.)
 Trefferkreis: 10.44 mm
 Trefferlage: 0.25 mm rechts, 1.09 mm hoch

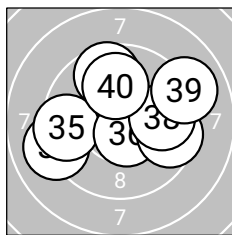

Serie 4: 98.6 (94)

9.1←	10.9*↘	10.5*↑	9.6↑	9.5←
10.6*↘	9.6↗	9.8↗	9.0↗	10.0↑

beste Teiler: 9.2 (32.), 91.3 (36.), 109.5 (33.)
 Trefferkreis: 14.01 mm
 Trefferlage: 0.19 mm rechts, 0.52 mm hoch



LG 40 ZR

StandNr: 116

Ascher,, Leonie #70404055

Jungschützinnen

Wertung

StartNr: 114

01.02.2026 13:37

SG_Breitenbach

Ergebnis: **411.7 (393)**
 Serien: 103.9 102.9 102.3 102.6
 Zähler: 33 7 0 0 0 0 0 0 0 0
 Innenzehner: 28
 Weitester: 344 (4.), 338 (36.), 325 (26.)
 beste Teiler: 38.0 (3.), 50.9 (33.), 53.0 (6.)
 Trefferkreis: 11.32 mm
 Trefferlage: 0.36 mm links, 0.20 mm tief

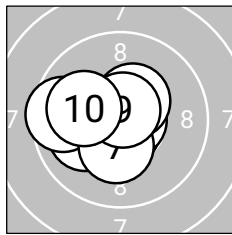
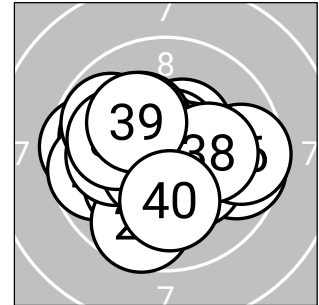
**Serie 1: 103.9 (99)**

10.1 ← 10.7* ↓ 10.8* ↑ 9.6 ← 10.6* ↑
 10.7* → 10.3* ↓ 10.4* ↗ 10.7* ↑ 10.0 ←

beste Teiler: 38.0 (3.), 53.0 (6.), 59.9 (9.)
 Trefferkreis: 8.81 mm
 Trefferlage: 0.59 mm links, 0.09 mm hoch

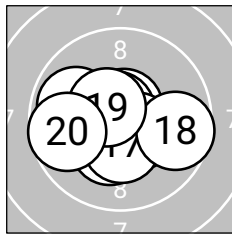
**Serie 2: 102.9 (97)**

10.3* ↓ 10.7* ↑ 10.5* ↓ 9.9 ← 10.7* ↖
 10.5* ↘ 10.4* ↓ 9.7 → 10.5* ↖ 9.7 ←

beste Teiler: 57.7 (15.), 68.9 (12.), 104.1 (19.)
 Trefferkreis: 10.73 mm
 Trefferlage: 0.28 mm links, 0.34 mm tief

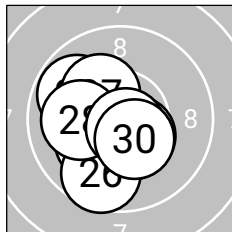
**Serie 3: 102.3 (98)**

9.8 ↖ 10.2* ↖ 10.4* ↘ 10.4* ↘ 10.4* ←
 9.7 ↓ 10.2* ↖ 10.1 ← 10.7* ↘ 10.4* ↘

beste Teiler: 59.1 (29.), 128.8 (23.), 132.4 (24.)
 Trefferkreis: 9.19 mm
 Trefferlage: 0.72 mm links, 0.53 mm tief

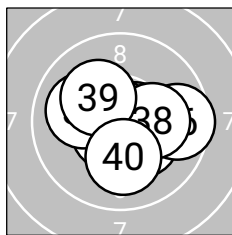
**Serie 4: 102.6 (99)**

10.6* → 10.6* ↖ 10.8* ↖ 10.3* ↘ 10.2* ↖
 9.6 → 10.0 ← 10.2* → 10.2* ↖ 10.1 ↓

beste Teiler: 50.9 (33.), 87.4 (31.), 89.8 (32.)
 Trefferkreis: 10.11 mm
 Trefferlage: 0.14 mm rechts, 0.04 mm tief



Ergebnis: 401.4 (383)
Serien: 101.4 99.2 100.5 100.3
Zähler: 26 11 3 0 0 0 0 0 0 0
Innenzehner: 24
Weiteste: 680 (26.), 621 (39.), 580 (18.)
beste Teiler: 67.0 (23.), 73.5 (7.), 76.6 (14.)
Trefferkreis: 14.42 mm
Trefferlage: 0.93 mm links, 0.01 mm tief

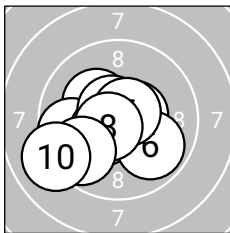
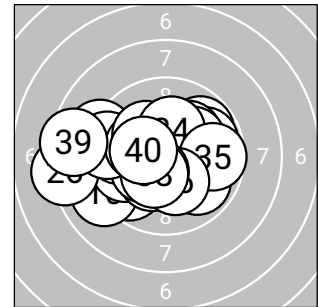

Serie 1: 101.4 (96)

10.2*↖	10.5*➔	9.7↖	10.5*↖	10.6*↖
9.9↘	10.7*↗	10.6*↖	9.7↖	9.0↖

beste Teiler: 73.5 (7.), 79.3 (5.), 80.4 (8.)
Trefferkreis: 10.75 mm
Trefferlage: 0.93 mm links, 0.56 mm tief

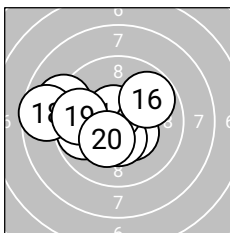

Serie 2: 99.2 (94)

10.5*↙	10.4*↘	10.4*↓	10.6*↖	9.8↖
9.8↗	9.1↖	8.6↖	9.7↖	10.3*↖

beste Teiler: 76.6 (14.), 120.5 (11.), 135.0 (13.)
Trefferkreis: 12.63 mm
Trefferlage: 1.45 mm links, 0.05 mm tief

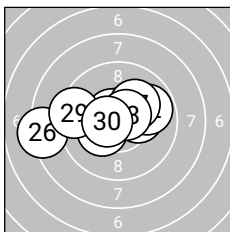

Serie 3: 100.5 (96)

10.2*➔	9.8➔	10.7*↑	10.6*↖	10.3*↖
8.2↖	10.1↗	10.6*↗	9.4↖	10.6*↖

beste Teiler: 67.0 (23.), 85.5 (24.), 86.8 (28.)
Trefferkreis: 14.04 mm
Trefferlage: 0.73 mm links, 0.33 mm hoch

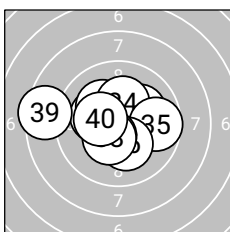

Serie 4: 100.3 (97)

10.2*↖	10.1↗	10.2*↖	10.2*↑	9.7➔
10.2*↓	10.5*↙	10.4*↙	8.5↖	10.3*↖

beste Teiler: 125.6 (37.), 142.0 (38.), 154.7 (40.)
Trefferkreis: 13.84 mm
Trefferlage: 0.63 mm links, 0.22 mm hoch



Ergebnis: 404.9 (386)
Serien: 102.3 101.1 102.1 99.4
Zähler: 26 14 0 0 0 0 0 0 0 0
Innenzehner: 19
Weiteste: 471 (38.), 383 (36.), 379 (17.)
beste Teiler: 14.5 (40.), 43.3 (8.), 45.1 (19.)
Trefferkreis: 12.47 mm
Trefferlage: 0.44 mm rechts, 0.24 mm hoch

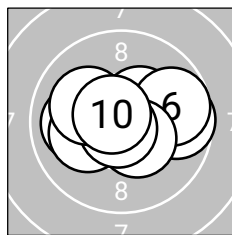
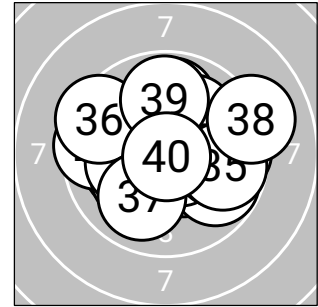

Serie 1: 102.3 (98)

9.7→	10.0←	10.4*↗	10.3*↖	10.1←
9.8→	10.4*↘	10.8*↙	10.1↖	10.7*↖

beste Teiler: 43.3 (8.), 69.2 (10.), 132.9 (7.)
Trefferkreis: 10.06 mm
Trefferlage: 0.05 mm links, 0.18 mm hoch

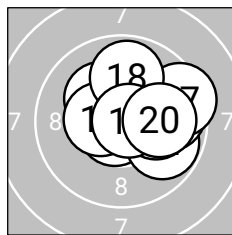

Serie 2: 101.1 (96)

10.2*↖	10.7*↙	10.4*←	9.8↘	10.1→
9.8→	9.4→	9.9↑	10.8*→	10.0→

beste Teiler: 45.1 (19.), 61.0 (12.), 127.6 (13.)
Trefferkreis: 9.47 mm
Trefferlage: 1.12 mm rechts, 0.42 mm hoch

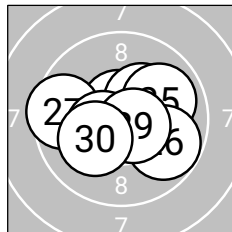

Serie 3: 102.1 (97)

10.4*↗	10.2*→	10.7*↑	10.3*↗	9.9↘
9.8↘	9.5←	10.5*←	10.6*↘	10.2*↖

beste Teiler: 73.4 (23.), 82.8 (29.), 124.3 (28.)
Trefferkreis: 10.81 mm
Trefferlage: 0.35 mm rechts, 0.05 mm hoch

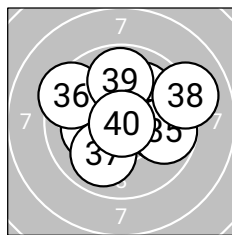

Serie 4: 99.4 (95)

10.3*↖	10.2*←	9.9→	10.0↗	9.8→
9.4↖	10.0↙	9.1→	9.8↑	10.9*↘

beste Teiler: 14.5 (40.), 163.8 (31.), 192.1 (32.)
Trefferkreis: 12.32 mm
Trefferlage: 0.35 mm rechts, 0.32 mm hoch



Ergebnis: 400.2 (386)
Serien: 101.5 99.5 100.1 99.1
Zähler: 27 12 1 0 0 0 0 0 0 0
Innenzehner: 20
Weiteste: 628 (33.), 438 (31.), 401 (11.)
beste Teiler: 60.5 (27.), 101.8 (9.), 102.9 (13.)
Trefferkreis: 14.60 mm
Trefferlage: 0.18 mm rechts, 0.14 mm hoch

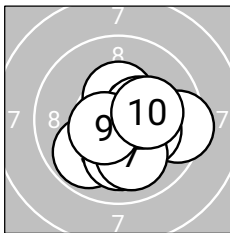
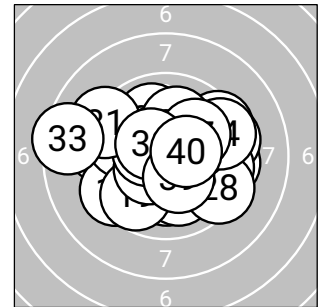

Serie 1: 101.5 (98)

9.5→	10.3*↙	10.4*↑	10.2*→	9.9↙
10.1↓	10.0↓	10.4*→	10.5*↙	10.2*→

beste Teiler: 101.8 (9.), 136.6 (8.), 138.0 (3.)
Trefferkreis: 10.28 mm
Trefferlage: 0.57 mm rechts, 0.70 mm tief

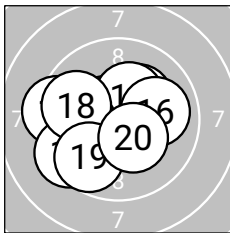

Serie 2: 99.5 (96)

9.3←	10.2*↗	10.5*↙	10.3*↗	10.0←
10.0→	9.4↙	9.8←	9.7↙	10.3*↘

beste Teiler: 102.9 (13.), 152.8 (20.), 161.0 (14.)
Trefferkreis: 10.94 mm
Trefferlage: 0.97 mm links, 0.08 mm tief

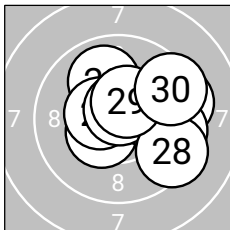

Serie 3: 100.1 (96)

10.4*↙	10.0↑	9.4→	10.2*→	10.5*↙
9.6→	10.7*↑	9.4→	10.5*↗	9.4→

beste Teiler: 60.5 (27.), 119.2 (25.), 120.3 (29.)
Trefferkreis: 10.59 mm
Trefferlage: 1.29 mm rechts, 0.43 mm hoch

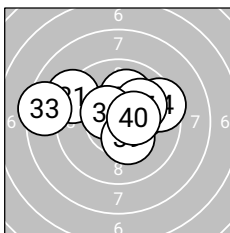

Serie 4: 99.1 (96)

9.2↙	10.2*→	8.4←	9.5→	10.5*↙
10.1↑	10.0→	10.5*↙	10.3*↘	10.4*→

beste Teiler: 110.4 (35.), 120.8 (38.), 132.2 (40.)
Trefferkreis: 14.13 mm
Trefferlage: 0.17 mm links, 0.95 mm hoch



Ergebnis: 394.9 (377)
Serien: 98.7 100.8 96.1 99.3
Zähler: 18 21 1 0 0 0 0 0 0 0
Innenzehner: 13
Weiteste: 630 (24.), 475 (23.), 455 (10.)
beste Teiler: 26.3 (15.), 65.8 (2.), 78.7 (21.)
Trefferkreis: 15.36 mm
Trefferlage: 0.92 mm links, 0.43 mm hoch

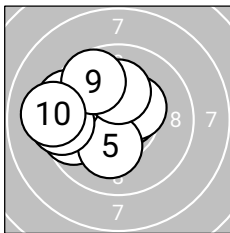
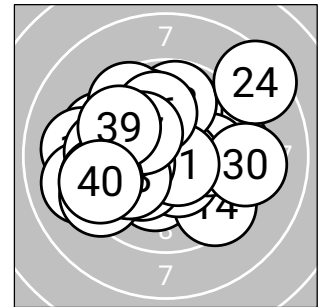

Serie 1: 98.7 (94)

9.8 ←	10.7* ↗	10.4* ↗	9.7 ←	10.2* ↓
9.5 ←	10.2* ↑	9.4 ←	9.7 ↘	9.1 ←

beste Teiler: 65.8 (2.), 139.8 (3.), 191.0 (5.)
Trefferkreis: 10.17 mm
Trefferlage: 1.85 mm links, 0.41 mm hoch

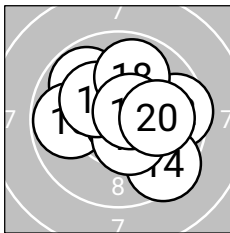

Serie 2: 100.8 (95)

9.8 ↖	9.6 →	9.8 ←	9.5 ↘	10.8* →
10.5* ↘	10.3* ↖	9.9 ↑	10.6* ↗	10.0 →

beste Teiler: 26.3 (15.), 85.9 (19.), 125.3 (16.)
Trefferkreis: 11.06 mm
Trefferlage: 0.48 mm rechts, 0.30 mm hoch

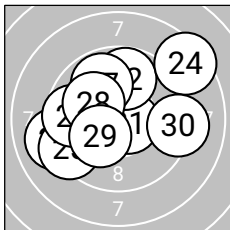

Serie 3: 96.1 (92)

10.6* ↗	9.8 ↑	9.1 ←	8.4 ↗	9.3 ←
9.6 ←	9.8 ↘	10.1 ↖	10.2* ↖	9.2 →

beste Teiler: 78.7 (21.), 181.0 (29.), 212.7 (28.)
Trefferkreis: 15.36 mm
Trefferlage: 0.52 mm links, 0.52 mm hoch

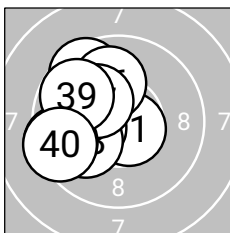

Serie 4: 99.3 (96)

10.6* ↗	10.2* ←	10.0 ←	10.0 ↖	9.6 ↖
10.0 ↑	10.2* ↖	9.5 ←	9.8 ↖	9.4 ←

beste Teiler: 79.0 (31.), 179.8 (32.), 182.5 (37.)
Trefferkreis: 9.54 mm
Trefferlage: 1.82 mm links, 0.48 mm hoch



Ergebnis: 381.9 (362)
Serien: 93.2 95.4 95.6 97.7
Zähler: 15 14 9 2 0 0 0 0 0 0
Innenzehner: 11
Weiteste: 792 (4.), 788 (18.), 734 (29.)
beste Teiler: 20.2 (10.), 56.7 (5.), 71.8 (14.)
Trefferkreis: 20.30 mm
Trefferlage: 0.43 mm rechts, 0.73 mm hoch

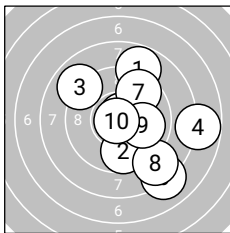
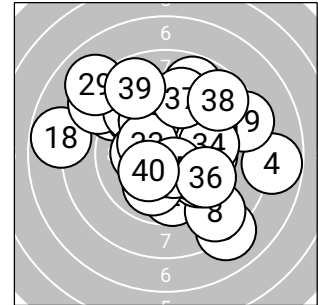

Serie 1: 93.2 (87)

8.8 ↗ 9.7 ↓ 8.9 ↖ 7.8 → 10.7* ↗
 8.1 ↘ 9.6 ↗ 8.7 ↘ 10.0 → 10.9* ↖

beste Teiler: 20.2 (10.), 56.7 (5.), 246.4 (9.)
Trefferkreis: 17.15 mm
Trefferlage: 1.93 mm rechts, 0.29 mm tief

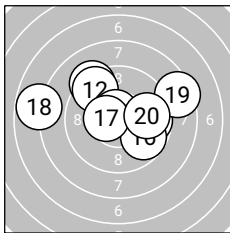

Serie 2: 95.4 (90)

9.2 ↖ 9.5 ↖ 9.7 → 10.7* ↖ 10.0 →
 9.8 ↘ 10.5* ← 7.8 ← 8.4 → 9.8 →

beste Teiler: 71.8 (14.), 118.3 (17.), 250.8 (15.)
Trefferkreis: 18.15 mm
Trefferlage: 0.24 mm rechts, 0.84 mm hoch

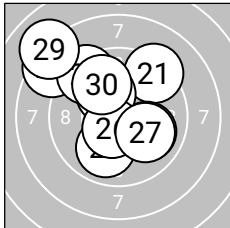

Serie 3: 95.6 (92)

9.3 ↗ 10.0 → 8.4 ↖ 10.2* ↖ 9.9 ↘
 10.6* ↘ 10.0 → 9.3 ↖ 8.0 ↖ 9.9 ↖

beste Teiler: 98.4 (26.), 196.8 (24.), 235.6 (27.)
Trefferkreis: 14.17 mm
Trefferlage: 0.94 mm links, 1.41 mm hoch

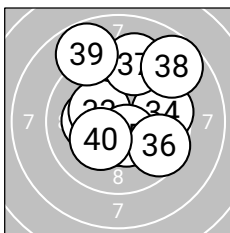

Serie 4: 97.7 (93)

10.6* ↓ 10.2* ← 10.3* ↖ 9.6 → 10.5* ↘
 9.6 → 9.2 ↑ 8.7 ↗ 8.8 ↖ 10.2* ↖

beste Teiler: 96.5 (31.), 118.3 (35.), 158.1 (33.)
Trefferkreis: 12.95 mm
Trefferlage: 0.49 mm rechts, 0.96 mm hoch



Ergebnis: 399.1 (383)
Serien: 97.6 100.6 98.7 102.2
Zähler: 25 13 2 0 0 0 0 0 0 0
Innenzehner: 19
Weiteste: 629 (2.), 526 (11.), 462 (4.)
beste Teiler: 36.2 (16.), 61.0 (38.), 65.5 (36.)
Trefferkreis: 15.34 mm
Trefferlage: 0.03 mm rechts, 0.26 mm hoch

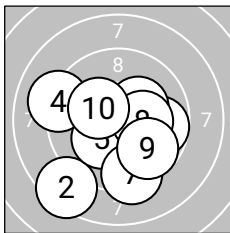
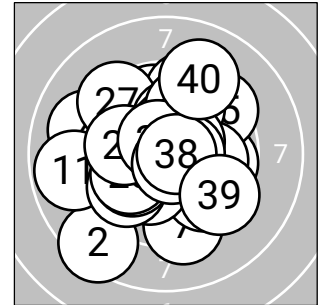

Serie 1: 97.6 (94)

10.4*↘ 8.4↙ 9.7→ 9.1↖ 10.2*↙
 10.3*↗ 9.3↓ 10.2*→ 9.7↘ 10.3*↖

beste Teiler: 149.2 (1.), 168.9 (10.), 173.1 (6.)
Trefferkreis: 13.14 mm
Trefferlage: 0.07 mm links, 1.11 mm tief

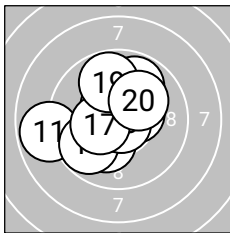

Serie 2: 100.6 (95)

8.8↖ 10.4*↗ 10.2*↙ 9.8↙ 10.5*↖
 10.8*↘ 10.4*↖ 9.8↗ 9.8↖ 10.1↗

beste Teiler: 36.2 (16.), 111.7 (15.), 131.9 (12.)
Trefferkreis: 11.75 mm
Trefferlage: 0.68 mm links, 0.28 mm hoch

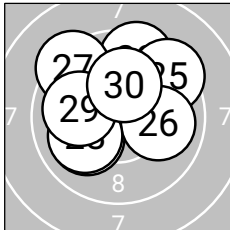

Serie 3: 98.7 (97)

10.0↖ 9.5↗ 10.0↗ 10.3*↖ 9.4↗
 10.0→ 9.3↖ 10.0↖ 10.0↖ 10.2*↗

beste Teiler: 156.5 (24.), 197.3 (30.), 226.8 (21.)
Trefferkreis: 10.89 mm
Trefferlage: 0.05 mm links, 1.11 mm hoch

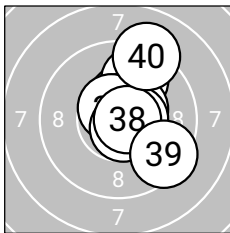

Serie 4: 102.2 (97)

10.4*↗ 9.8↗ 10.6*↗ 10.4*↗ 10.6*↖
 10.7*↘ 10.5*→ 10.7*→ 9.4↘ 9.1↗

beste Teiler: 61.0 (38.), 65.5 (36.), 91.4 (35.)
Trefferkreis: 11.13 mm
Trefferlage: 0.93 mm rechts, 0.77 mm hoch



Ergebnis: 386.9 (369)
Serien: 95.5 94.2 96.9 100.3
Zähler: 15 19 6 0 0 0 0 0 0 0
Innenzehner: 13
Weiteste: 606 (3.), 604 (15.), 601 (18.)
beste Teiler: 55.9 (40.), 69.3 (36.), 78.3 (19.)
Trefferkreis: 16.59 mm
Trefferlage: 0.37 mm links, 0.37 mm tief

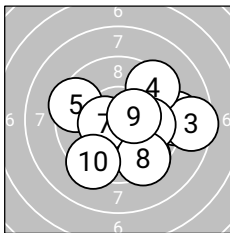
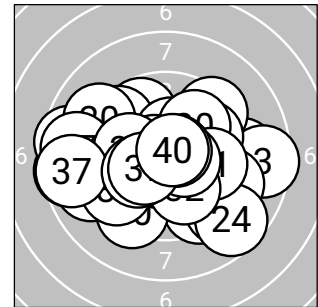

Serie 1: 95.5 (91)

9.5 ↘	9.1 →	8.5 →	9.4 ↗	9.5 ↖
9.9 →	10.5* ↖	9.4 ↘	10.4* →	9.3 ↘

beste Teiler: 115.9 (7.), 133.4 (9.), 254.3 (6.)
Trefferkreis: 14.25 mm
Trefferlage: 1.48 mm rechts, 0.64 mm tief

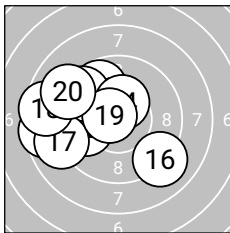

Serie 2: 94.2 (90)

9.7 ↖	9.8 ↖	9.5 ↖	10.4* ↗	8.5 ↖
9.1 ↘	9.0 ↖	8.5 ↖	10.6* ↖	9.1 ↖

beste Teiler: 78.3 (19.), 143.3 (14.), 276.9 (12.)
Trefferkreis: 14.77 mm
Trefferlage: 2.48 mm links, 0.28 mm hoch

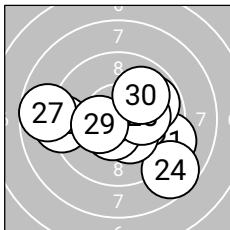

Serie 3: 96.9 (92)

9.3 ↘	9.2 ↖	9.8 ↗	8.7 ↘	10.3* ↘
10.5* ↘	8.7 ↖	10.2* →	10.3* ↖	9.9 ↗

beste Teiler: 108.7 (26.), 153.1 (29.), 153.8 (25.)
Trefferkreis: 15.12 mm
Trefferlage: 0.31 mm rechts, 0.49 mm tief

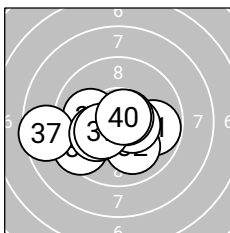

Serie 4: 100.3 (96)

9.8 →	10.0 ↘	9.5 ↖	10.5* →	10.0 ↖
10.7* →	8.6 ↖	10.2* ↖	10.3* ↖	10.7* →

beste Teiler: 55.9 (40.), 69.3 (36.), 119.5 (34.)
Trefferkreis: 13.20 mm
Trefferlage: 0.80 mm links, 0.64 mm tief



Ergebnis: **393.6 (372)**
Serien: 97.3 97.7 97.7 100.9
Zähler: 15 22 3 0 0 0 0 0 0 0
Innenzehner: 13
Weiteste: 604 (12.), 555 (7.), 513 (36.)
beste Teiler: 23.2 (20.), 56.6 (29.), 68.4 (38.)
Trefferkreis: 15.76 mm
Trefferlage: 0.58 mm rechts, 0.15 mm tief

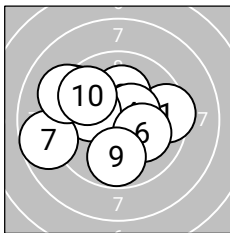
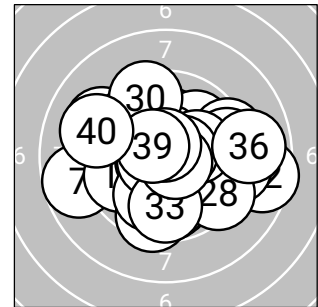

Serie 1: 97.3 (93)

9.5➔	10.2*↑	9.4↖	10.5*➔	10.1↖
10.1➔	8.7↖	9.2↖	9.8↓	9.8↖

beste Teiler: 110.9 (4.), 193.6 (2.), 207.6 (6.)
Trefferkreis: 13.74 mm
Trefferlage: 1.05 mm links, 0.38 mm hoch

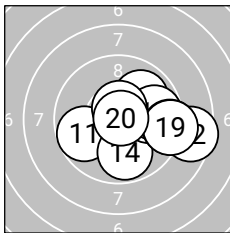

Serie 2: 97.7 (91)

9.7↖	8.5➔	9.9↗	9.9↓	9.9➔
9.8➔	9.3➔	10.6*↑	9.2➔	10.9*➔

beste Teiler: 23.2 (20.), 91.4 (18.), 251.9 (15.)
Trefferkreis: 13.20 mm
Trefferlage: 1.97 mm rechts, 0.27 mm tief

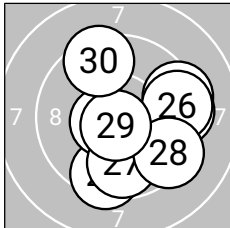

Serie 3: 97.7 (93)

9.5↓	10.2*↘	9.3➔	10.6*↖	9.4➔
9.4➔	9.8↓	9.4➔	10.7*↓	9.4↖

beste Teiler: 56.6 (29.), 90.1 (24.), 200.4 (22.)
Trefferkreis: 12.12 mm
Trefferlage: 1.26 mm rechts, 0.55 mm tief

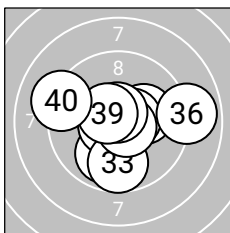

Serie 4: 100.9 (95)

9.9↓	10.6*↖	9.7↓	10.2*➔	10.6*➔
8.9➔	10.7*➔	10.7*↑	10.5*↖	9.1↖

beste Teiler: 68.4 (38.), 71.0 (37.), 79.7 (32.)
Trefferkreis: 13.90 mm
Trefferlage: 0.16 mm rechts, 0.18 mm tief



Ergebnis: 389.2 (371)
Serien: 96.9 98.6 98.5 95.2
Zähler: 15 21 4 0 0 0 0 0 0 0
Innenzehner: 10
Weiteste: 650 (15.), 636 (31.), 635 (7.)
beste Teiler: 10.4 (16.), 105.4 (18.), 108.0 (4.)
Trefferkreis: 15.21 mm
Trefferlage: 0.03 mm links, 0.57 mm hoch

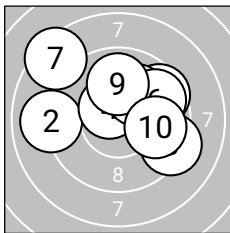
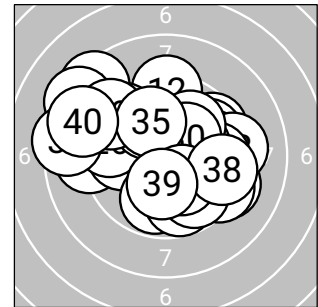

Serie 1: 96.9 (92)

10.5*↑ 9.0← 9.6➡ 10.5*↖ 10.1↗
 9.7↘ 8.4↙ 9.3➤ 9.9↑ 9.9➔

beste Teiler: 108.0 (4.), 119.6 (1.), 223.0 (5.)
Trefferkreis: 14.93 mm
Trefferlage: 0.31 mm rechts, 1.16 mm hoch

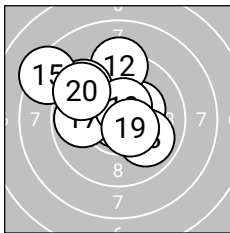

Serie 2: 98.6 (93)

10.3*➤ 9.3↑ 9.9➤ 9.5↖ 8.4↖
 10.9*↖ 9.8← 10.5*↗ 10.5*➤ 9.5↖

beste Teiler: 10.4 (16.), 105.4 (18.), 114.0 (19.)
Trefferkreis: 13.60 mm
Trefferlage: 0.90 mm links, 1.19 mm hoch

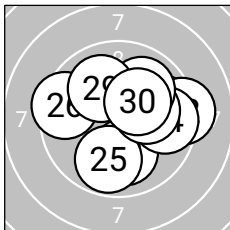

Serie 3: 98.5 (95)

9.7➔ 9.2➔ 10.1↓ 9.7➔ 9.8↓
 9.5↖ 10.2*➤ 10.0↗ 10.0↖ 10.3*➤

beste Teiler: 174.2 (30.), 198.6 (27.), 225.9 (23.)
Trefferkreis: 12.37 mm
Trefferlage: 1.01 mm rechts, 0.28 mm hoch

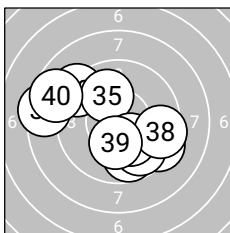

Serie 4: 95.2 (91)

8.4← 9.2↖ 9.8↓ 9.4➤ 10.0↖
 9.8↘ 10.2*↘ 9.5➔ 10.2*↓ 8.7↖

beste Teiler: 180.6 (39.), 185.0 (37.), 238.7 (35.)
Trefferkreis: 14.65 mm
Trefferlage: 0.55 mm links, 0.33 mm tief



Ergebnis: 387.3 (369)
Serien: 89.6 97.2 99.5 101.0
Zähler: 19 18 2 0 0 0 0 0 0 1 0
Innenzehner: 14
Weiteste: 2439 (8.), 609 (19.), 541 (32.)
beste Teiler: 37.8 (37.), 59.0 (34.), 76.4 (31.)
Trefferkreis: 34.08 mm
Trefferlage: 0.09 mm rechts, 0.67 mm hoch

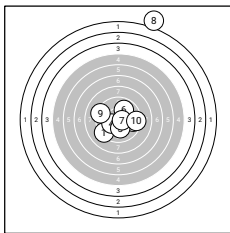
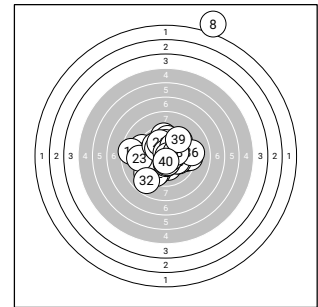

Serie 1: 89.6 (86)

9.2 ↙	10.3* ➔	9.6 ➔	10.2* ↙	10.1 ↓
9.9 ↗	10.6* ➔	1.2 ↗	9.2 ↙	9.3 ➔

beste Teiler: 84.8 (7.), 158.2 (2.), 182.2 (4.)
Trefferkreis: 32.87 mm
Trefferlage: 1.07 mm rechts, 2.06 mm hoch

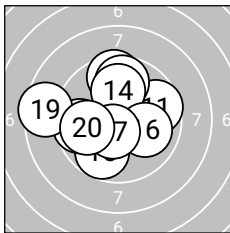

Serie 2: 97.2 (92)

9.6 ➔	9.5 ↑	9.7 ↑	10.0 ↑	9.8 ↙
10.0 ➔	10.5* ↙	9.7 ↙	8.5 ↙	9.9 ↙

beste Teiler: 110.5 (17.), 235.0 (14.), 237.5 (16.)
Trefferkreis: 13.64 mm
Trefferlage: 0.83 mm links, 0.49 mm hoch

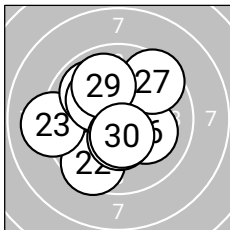

Serie 3: 99.5 (95)

10.4* ↙	9.5 ↙	9.1 ↙	9.9 ↙	10.2* ↙
10.1 ➔	9.5 ↗	10.4* ↓	9.9 ↙	10.5* ↓

beste Teiler: 118.8 (30.), 127.8 (21.), 132.2 (28.)
Trefferkreis: 12.13 mm
Trefferlage: 0.70 mm links, 0.05 mm hoch

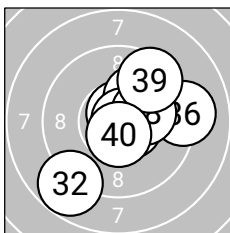

Serie 4: 101.0 (96)

10.6* ➔	8.8 ↙	10.6* ➔	10.7* ↑	10.1 ↗
9.1 ➔	10.8* ➔	10.2* ➔	9.5 ↗	10.6* ↓

beste Teiler: 37.8 (37.), 59.0 (34.), 76.4 (31.)
Trefferkreis: 13.78 mm
Trefferlage: 0.83 mm rechts, 0.10 mm hoch



Ergebnis: 384.6 (365)
Serien: 100.2 93.7 93.5 97.2
Zähler: 14 19 5 2 0 0 0 0 0 0
Innenzehner: 12
Weiteste: 881 (19.), 754 (16.), 579 (37.)
beste Teiler: 57.5 (11.), 73.7 (15.), 88.4 (3.)
Trefferkreis: 17.59 mm
Trefferlage: 0.97 mm rechts, 1.48 mm hoch

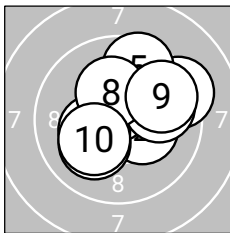
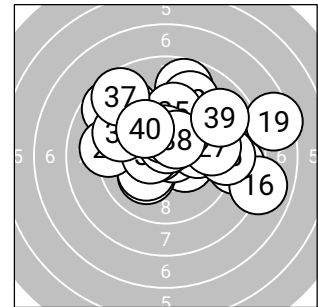

Serie 1: 100.2 (96)

9.3➔	10.3*➔	10.6*↑	10.3*↖	9.6↑
9.9➔	10.1↙	10.2*↑	9.7➔	10.2*↙

beste Teiler: 88.4 (3.), 160.3 (2.), 165.1 (4.)
Trefferkreis: 10.64 mm
Trefferlage: 0.66 mm rechts, 0.58 mm hoch

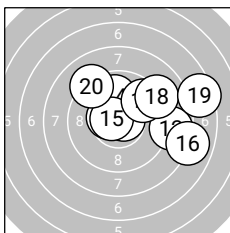

Serie 2: 93.7 (88)

10.7*➔	8.8➔	10.5*↖	9.9↑	10.7*↖
7.9➔	9.6➔	9.1➔	7.4➔	9.1↙

beste Teiler: 57.5 (11.), 73.7 (15.), 114.5 (13.)
Trefferkreis: 16.22 mm
Trefferlage: 2.32 mm rechts, 1.14 mm hoch

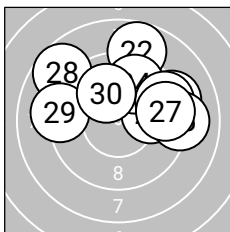

Serie 3: 93.5 (89)

9.2➔	8.8↑	9.9➔	9.7↑	9.4➔
9.1➔	9.5➔	8.7↙	9.2↖	10.0↙

beste Teiler: 231.1 (30.), 253.8 (23.), 308.4 (24.)
Trefferkreis: 14.21 mm
Trefferlage: 1.14 mm rechts, 1.89 mm hoch

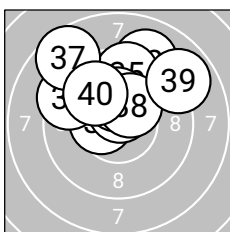

Serie 4: 97.2 (92)

10.5*↖	9.1↑	10.6*↑	9.4↖	9.6↑
10.3*↑	8.6↙	10.3*➔	8.9➔	9.9↙

beste Teiler: 91.7 (33.), 119.5 (31.), 152.5 (38.)
Trefferkreis: 12.47 mm
Trefferlage: 0.22 mm links, 2.33 mm hoch



LG 60 ZR

StandNr: 129

Köll, Jana #70113087

Juniorinnen

Wertung

StartNr: 126

01.02.2026 14:18

SG_Roppen

Ergebnis: **584.4 (560)**
 Serien: 97.8 97.3 95.5 98.3 98.6 96.9
 Zähler: 27 26 7 0 0 0 0 0 0 0
 Innenzehner: 16
 Weitestе: 626 (38.), 616 (5.), 589 (40.)
 beste Teiler: 29.1 (31.), 72.4 (37.), 75.4 (36.)
 Trefferkreis: 16.93 mm
 Trefferlage: 0.13 mm rechts, 0.06 mm tief

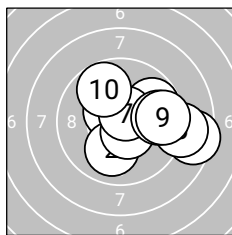
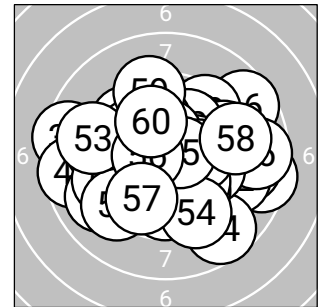

Serie 1: 97.8 (92)

10.5*↖ 10.0↓ 9.8➔ 10.5*↘ 8.5➔
 8.9➔ 10.6*↗ 9.7➔ 9.5➔ 9.8↖

beste Teiler: 81.5 (7.), 102.4 (4.), 118.1 (1.)
 Trefferkreis: 12.87 mm
 Trefferlage: 1.85 mm rechts, 0.12 mm hoch

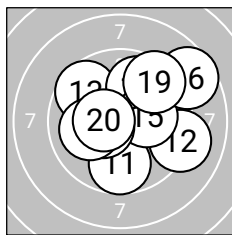

Serie 2: 97.3 (93)

9.7↓ 9.1➔ 9.6↖ 9.8↗ 10.2*➔
 8.6↗ 10.4*↖ 10.0↖ 9.4↗ 10.5*↖

beste Teiler: 120.2 (20.), 130.9 (17.), 194.5 (15.)
 Trefferkreis: 12.78 mm
 Trefferlage: 0.76 mm rechts, 0.56 mm hoch

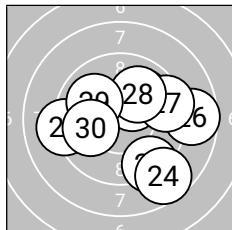

Serie 3: 95.5 (93)

9.2↖ 10.0↗ 9.2↘ 8.7↘ 10.3*↗
 8.7➔ 9.4➔ 10.0↗ 10.0↖ 10.0↖

beste Teiler: 160.0 (25.), 240.2 (28.), 246.0 (22.)
 Trefferkreis: 14.67 mm
 Trefferlage: 1.03 mm rechts, 0.17 mm tief

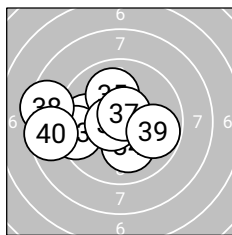

Serie 4: 98.3 (93)

10.8*➔ 9.8↖ 9.4↖ 10.1↓ 10.0↑
 10.7*↖ 10.7*↗ 8.4↖ 9.8➔ 8.6↖

beste Teiler: 29.1 (31.), 72.4 (37.), 75.4 (36.)
 Trefferkreis: 13.62 mm
 Trefferlage: 1.58 mm links, 0.07 mm tief

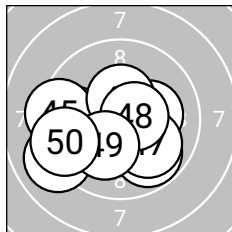

Serie 5: 98.6 (95)

10.2*➔ 9.8↘ 9.7↖ 9.0↖ 9.3↖
 10.4*↑ 10.0↘ 10.6*➔ 10.2*↘ 9.4↖

beste Teiler: 93.9 (48.), 135.0 (46.), 190.5 (41.)
 Trefferkreis: 11.12 mm
 Trefferlage: 0.93 mm links, 0.73 mm tief

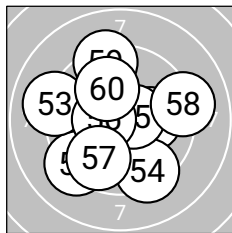

Serie 6: 96.9 (94)

10.1➔ 9.2↘ 9.1↖ 9.3↘ 10.6*➔
 10.5*↖ 9.7↘ 9.1➔ 9.3↑ 10.0↑

beste Teiler: 93.8 (55.), 115.0 (56.), 207.0 (51.)
 Trefferkreis: 13.61 mm
 Trefferlage: 0.30 mm links, 0.05 mm tief



LG 60 ZR

StandNr: 128

Entner, Amita #70818624

Frauen

Wertung

StartNr: 141

01.02.2026 14:02

T - SG Wörgl

Ergebnis: **600.2** (572)
 Serien: 101.6 101.3 98.6 98.5 101.2 99.0
 Zähler: 36 20 4 0 0 0 0 0 0 0
 Innenzehner: 31
 Weitestе: 666 (51.), 592 (22.), 534 (38.)
 beste Teiler: 46.6 (57.), 49.2 (8.), 52.7 (36.)
 Trefferkreis: 16.76 mm
 Trefferlage: 0.43 mm links, 0.24 mm tief

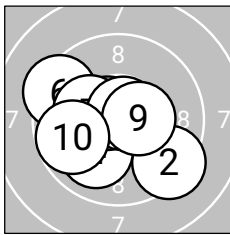
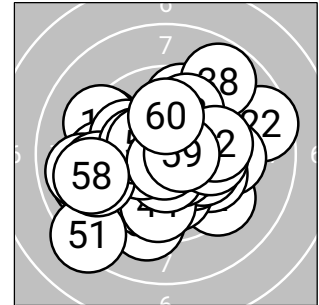
**Serie 1: 101.6** (97)

10.5*↙	9.3↘	10.4*↖	10.0↙	10.7*↖
9.4↖	10.2*↖	10.8*↗	10.5*↗	9.8↖

beste Teiler: 49.2 (8.), 75.4 (5.), 111.5 (1.)
 Trefferkreis: 12.46 mm
 Trefferlage: 0.78 mm links, 0.34 mm tief

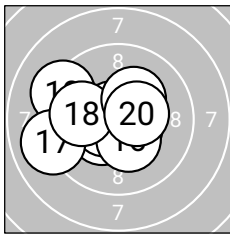
**Serie 2: 101.3** (97)

10.4*↙	10.6*↘	9.2↖	10.6*↖	10.7*↖
10.3*↘	9.0↖	9.9↖	10.2*↗	10.4*↗

beste Teiler: 58.0 (15.), 98.0 (14.), 100.7 (12.)
 Trefferkreis: 10.86 mm
 Trefferlage: 0.94 mm links, 0.03 mm tief

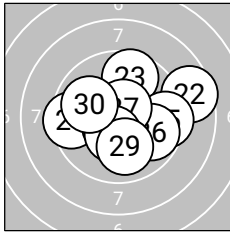
**Serie 3: 98.6** (94)

9.5↖	8.6↗	9.6↗	10.6*↙	9.5↗
9.8↗	10.6*↗	10.4*↘	10.0↘	10.0↖

beste Teiler: 84.1 (27.), 98.7 (24.), 142.6 (28.)
 Trefferkreis: 14.10 mm
 Trefferlage: 0.67 mm rechts, 0.05 mm hoch

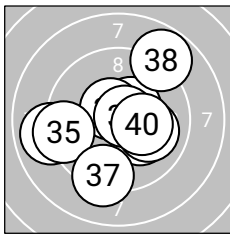
**Serie 4: 98.5** (94)

10.5*↗	10.6*↖	10.2*↘	8.9↖	9.3↖
10.7*↗	9.3↘	8.8↗	10.0↗	10.2*↗

beste Teiler: 52.7 (36.), 96.6 (32.), 125.1 (31.)
 Trefferkreis: 14.40 mm
 Trefferlage: 0.06 mm links, 0.20 mm tief

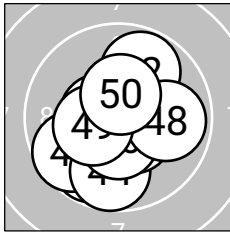
**Serie 5: 101.2** (95)

9.8↙	9.8↗	9.7↖	9.7↘	10.5*↘
10.5*↘	10.5*↖	9.9↗	10.4*↖	10.4*↗

beste Teiler: 103.5 (47.), 121.6 (45.), 122.0 (46.)
 Trefferkreis: 10.45 mm
 Trefferlage: 0.20 mm links, 0.61 mm tief

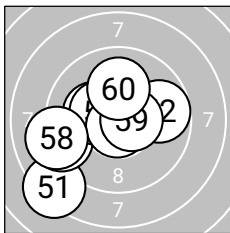
**Serie 6: 99.0** (95)

8.3↙	9.8↗	10.5*↗	9.2↖	10.2*↖
10.4*↖	10.8*↘	9.1↖	10.6*↗	10.1↗

beste Teiler: 46.6 (57.), 95.0 (59.), 102.9 (53.)
 Trefferkreis: 13.80 mm
 Trefferlage: 1.25 mm links, 0.30 mm tief

