

Ergebnis: **328** (347.4)

Wertung: 328 Serien: 39 32 45 37 40 44 45 46

Zähler: 6 13 12 4 3 1 1 0 0 0 0

Innenzehner: 2

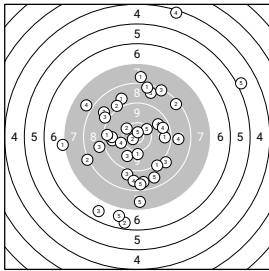

Wertung

Wertung

Serie 1:	7.9 [2.06] ↑	8.4 [3.34] ↗	9.0 [4.70] ↓	7.9 [5.85] ↖	8.6 [6.73] ↗
Serie 2:	9.6 [3.78] →	6.6 [4.70] ↓	8.3 [5.63] ↗	4.4 [6.97] ↗	5.0 [7.99] ↗
Serie 3:	8.9 [2.97] ↗	9.1 [4.32] ↖	9.9 [5.30] ↓	9.7 [6.41] ↗	10.3 [7.39] ↗
Serie 4:	8.4 [2.48] ↑	8.9 [3.83] ↖	6.7 [5.61] ↓	8.9 [6.59] →	7.7 [7.61] ↓
Serie 5:	7.2 [3.40] ←	9.7 [4.77] ←	9.0 [5.91] ←	9.7 [6.85] ←	6.8 [8.13] ↓
Serie 6:	10.1 [2.44] ↓	10.3 [4.14] ↖	8.6 [5.24] ↓	8.7 [6.62] ↓	8.5 [7.75] ↓
Serie 7:	9.4 [2.97] ←	10.7* [4.60] ←	9.0 [5.90] ↘	9.6 [7.31] →	8.7 [8.56] ↓
Serie 8:	9.2 [2.52] ↘	8.2 [4.17] ←	9.0 [5.66] ↖	10.1 [6.80] ←	10.7* [7.75] ↑

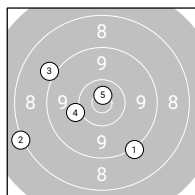
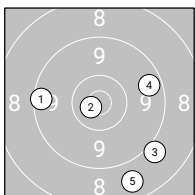
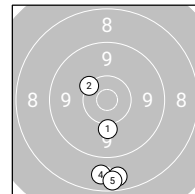
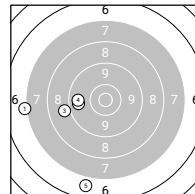
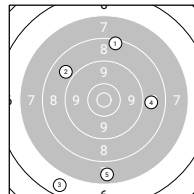
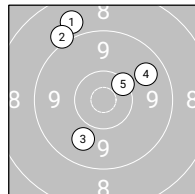
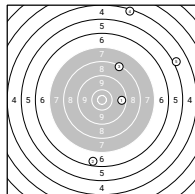
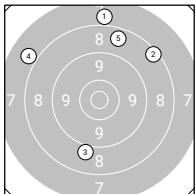

Ergebnis: **320** (337.6)

Wertung: 320 Serien: 37 36 39 37 42 44 40 45

Zähler: 5 9 11 11 4 0 0 0 0 0 0

Innenzehner: 2

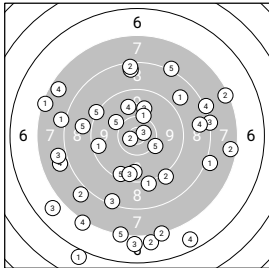

Wertung

Wertung

Serie 1:	7.3 [3.10] ←	7.9 [4.11] ↙	8.4 [5.15] ↓	7.9 [6.23] ←	8.2 [7.19] ↗
Serie 2:	6.0 [3.22] ↓	7.4 [4.07] →	6.9 [5.17] ↓	9.6 [6.06] ↓	8.5 [7.14] ↑
Serie 3:	8.1 [3.57] ←	7.0 [4.77] ↓	8.2 [5.72] →	6.6 [7.04] ↓	10.0 [7.94] ←
Serie 4:	9.5 [3.07] ←	7.2 [3.89] ↓	7.9 [4.82] ←	7.1 [5.79] ↓	7.2 [6.71] ↓
Serie 5:	8.1 [3.51] →	7.5 [4.39] →	9.9 [5.25] ↑	8.6 [6.24] →	10.2 [7.16] →
Serie 6:	9.1 [3.60] ↓	9.1 [4.70] ↓	10.7* [5.73] →	8.2 [6.63] →	8.9 [7.63] ←
Serie 7:	10.2 [3.20] ↗	8.4 [4.28] ↑	6.8 [5.44] ↙	7.6 [6.62] ←	9.4 [8.10] ↓
Serie 8:	8.8 [3.86] ↗	10.7* [4.56] ←	9.5 [5.54] ↓	9.8 [6.79] ↑	9.2 [8.30] ←

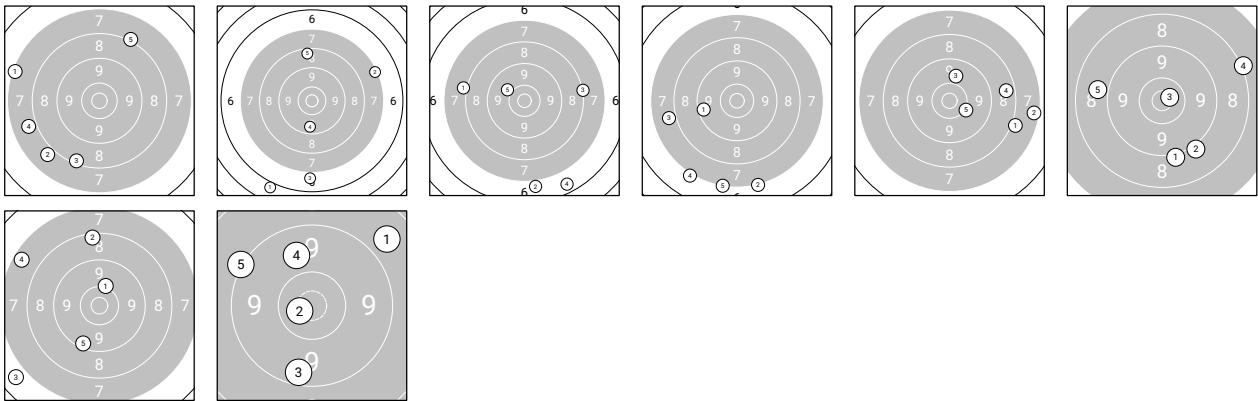

Ergebnis: **318** (336.7)

Wertung: 318 Serien: 45 38 38 36 42 39 46 34

Zähler: 7 8 10 7 7 1 0 0 0 0 0

Innenzehner: 3

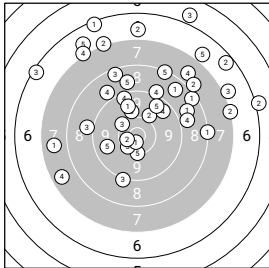

Wertung

Wertung

Serie 1:	6.4 [3.34] ↗	10.0 [4.72] ↗	10.2 [5.73] ↘	9.1 [6.78] ↗	10.3 [7.67] ↓
Serie 2:	8.2 [3.45] →	7.2 [5.01] ↘	8.4 [5.86] ↘	7.8 [6.91] ↗	8.9 [7.71] ↗
Serie 3:	7.7 [3.22] ←	6.1 [4.42] →	9.2 [5.72] ↓	7.6 [7.15] ←	9.7 [8.24] ←
Serie 4:	8.4 [3.04] ↗	8.0 [4.62] ↗	5.9 [5.43] ↗	9.6 [6.40] ↗	6.9 [7.52] ↘
Serie 5:	8.8 [2.86] ↗	7.2 [4.14] →	10.4* [5.58] ↘	8.9 [6.64] →	9.6 [7.80] ↗
Serie 6:	10.7* [3.30] ↓	6.9 [4.32] ↑	7.1 [5.55] →	8.9 [6.64] ↘	8.3 [7.60] ↗
Serie 7:	8.6 [3.62] ↗	10.5* [4.63] ←	9.0 [5.52] ←	9.4 [6.29] ↗	10.0 [7.38] ↗
Serie 8:	9.8 [3.15] ↗	6.5 [4.25] ↗	6.4 [5.18] ↘	7.2 [6.19] ↘	6.9 [7.38] ↗

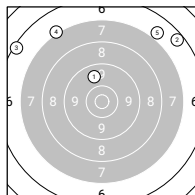
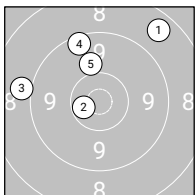
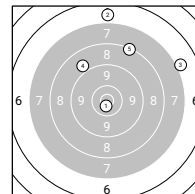
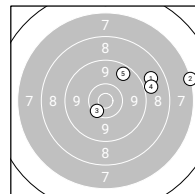
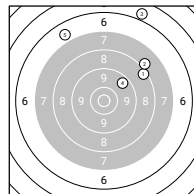
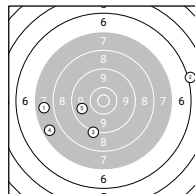
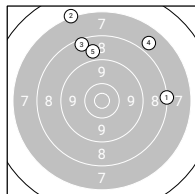
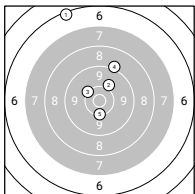

Ergebnis: **313** (329.6)

Wertung: 313 Serien: 34 39 40 43 40 36 40 41

Zähler: 6 10 9 6 5 3 1 0 0 0 0

Innenzehner: 3

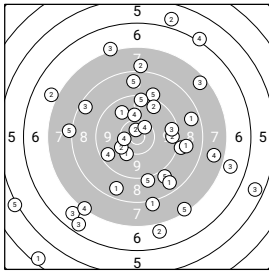

Wertung

Wertung

Serie 1:	4.4 [3.61] ↙	10.7* [4.99] ↑	6.9 [6.21] ➔	6.1 [7.25] ↗	8.6 [8.46] ↑
Serie 2:	10.1 [3.89] ↙	6.9 [5.24] ↓	5.6 [6.64] ➔	9.1 [7.91] ➔	9.1 [8.96] ↓
Serie 3:	8.9 [3.73] ➔	10.2 [5.27] ↙	6.8 [6.52] ↙	7.7 [7.72] ➔	9.1 [8.76] ↗
Serie 4:	8.1 [4.38] ↓	9.5 [5.65] ➔	7.1 [6.86] ↑	10.4* [7.75] ↗	9.0 [8.60] ↘
Serie 5:	8.6 [3.81] ↙	9.5 [4.96] ↗	6.6 [6.19] ↙	10.4* [7.36] ↖	7.4 [8.55] ↘
Serie 6:	8.6 [4.62] ↘	5.9 [5.72] ↗	9.5 [6.80] ➔	9.5 [7.73] ↙	5.1 [8.58] ↙
Serie 7:	9.8 [4.35] ↘	7.0 [5.63] ↖	8.5 [6.69] ↖	7.3 [7.69] ↙	9.4 [8.86] ↑
Serie 8:	8.6 [3.51] ➔	8.0 [4.69] ↑	7.5 [5.68] ↗	10.0 [6.69] ↑	8.1 [7.71] ↖

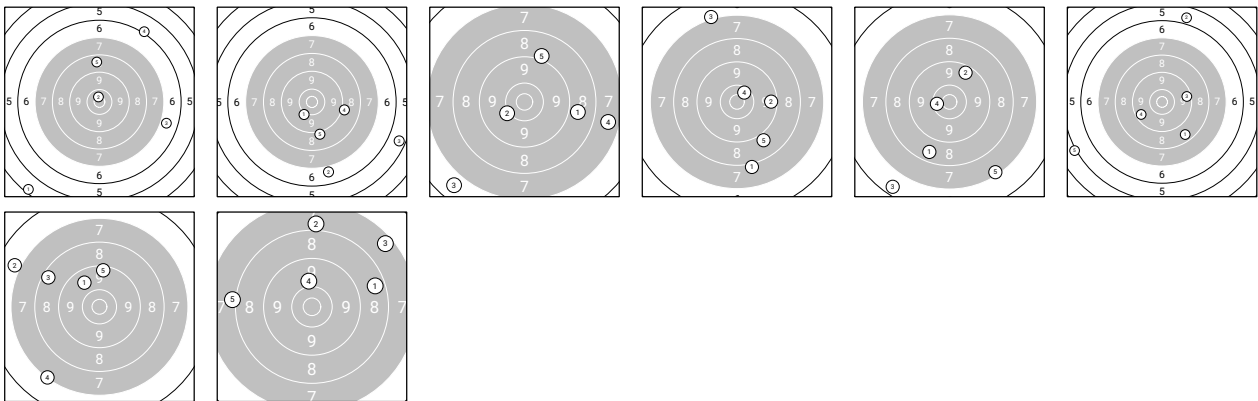

Ergebnis: **332** (351.7)

Wertung: 332 Serien: 40 44 44 45 33 42 42 42

Zähler: 8 9 14 6 2 1 0 0 0 0 0

Innenzehner: 4

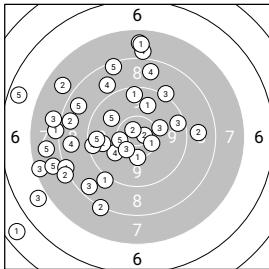

Wertung

Wertung

Serie 1:	8.1 [3.76] ←	8.2 [4.95] ↘	7.4 [5.95] ←	10.0 [6.65] ↘	7.8 [7.66] ←
Serie 2:	9.1 [3.88] ↘	10.7* [5.32] →	10.1 [6.17] →	8.6 [7.15] ↑	7.9 [7.92] ←
Serie 3:	10.2 [3.58] ↓	8.8 [4.62] →	8.0 [5.82] ←	8.0 [6.63] ↑	10.3 [8.03] ←
Serie 4:	9.5 [3.44] ↑	10.7* [4.58] ↗	10.4* [5.82] ↘	8.3 [6.62] ←	8.7 [7.59] ↘
Serie 5:	5.6 [3.77] ↘	7.8 [5.65] ↘	8.6 [6.41] ↘	7.7 [7.07] ↑	6.6 [8.40] ←
Serie 6:	10.4* [3.56] ↗	9.7 [4.56] ←	6.9 [5.28] ←	8.6 [6.36] ←	9.9 [7.32] ↘
Serie 7:	7.7 [3.71] ↑	8.6 [4.58] ←	9.5 [5.62] →	9.4 [6.44] ←	9.5 [7.16] ←
Serie 8:	9.8 [3.89] ↑	8.1 [5.09] ↘	9.2 [6.22] ↗	8.9 [7.09] ↗	8.4 [8.18] ↗

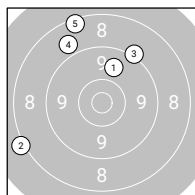
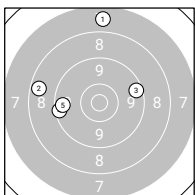
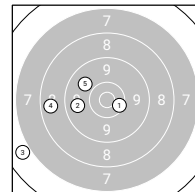
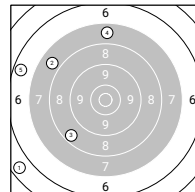
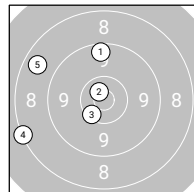
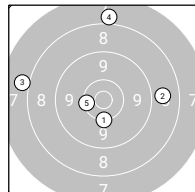
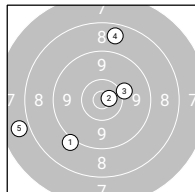
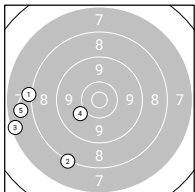

Ergebnis: **321** (340.9)

Wertung: 321 Serien: 38 37 44 39 44 43 34 42

Zähler: 2 17 8 8 4 0 1 0 0 0 0

Innenzehner: 1

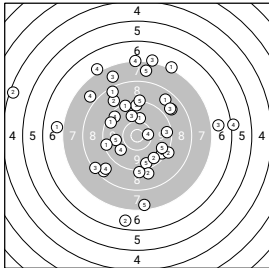

Wertung

Wertung

Serie 1:	7.1 [3.93] ↗	9.4 [5.27] ↘	6.9 [6.62] →	7.2 [7.87] ↑	9.5 [9.13] ↓
Serie 2:	6.9 [3.47] ←	9.2 [5.13] ↘	7.1 [6.09] ↑	6.1 [7.17] →	9.4 [8.06] ↑
Serie 3:	10.1 [4.53] ↑	8.9 [5.74] ↘	7.8 [6.63] ↗	10.4* [7.45] →	9.6 [8.84] ↘
Serie 4:	9.3 [4.92] ↗	6.7 [6.22] ↓	8.5 [7.20] ↘	9.5 [8.13] ↘	7.5 [8.98] ↓
Serie 5:	8.7 [4.52] ↗	9.6 [5.77] ↘	9.9 [6.73] ↑	9.9 [7.55] ↘	9.2 [8.45] ↑
Serie 6:	9.5 [3.78] ←	8.8 [5.05] ↗	9.5 [5.96] →	8.7 [6.87] ↘	9.9 [7.88] ←
Serie 7:	8.4 [3.78] ↗	4.4 [4.98] ←	8.8 [5.94] ↗	7.9 [6.91] ↘	7.7 [7.71] ↑
Serie 8:	9.4 [5.18] ←	9.0 [6.09] ↓	8.3 [7.08] ↘	7.1 [7.98] ↗	9.1 [8.66] ↓

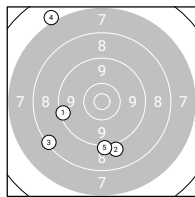
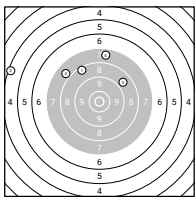
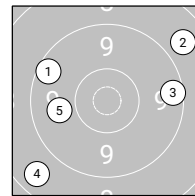
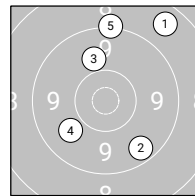
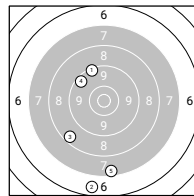
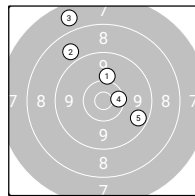
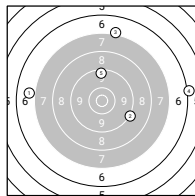
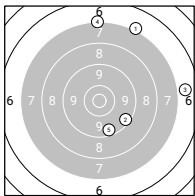

Ergebnis: **322** (338.6)

Wertung: 322 Serien: 39 43 40 40 40 39 46 35

Zähler: 8 9 10 6 5 1 1 0 0 0 0

Innenzehner: 2

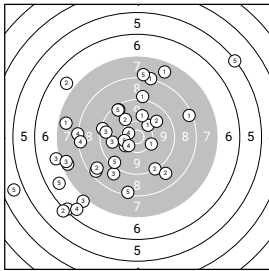

Wertung

Wertung

Serie 1:	7.7 [4.32] ↗	9.3 [5.96] ↘	8.9 [6.94] ↘	10.3 [8.71] ↙	5.3 [9.58] ↗
Serie 2:	7.6 [3.88] ↖	9.4 [5.06] ↗	9.8 [6.01] ↖	9.3 [6.97] ↖	9.4 [8.02] ↗
Serie 3:	10.2 [3.93] ↗	8.8 [5.00] ↘	8.5 [6.65] ↙	6.3 [8.02] ↙	8.4 [8.94] ↘
Serie 4:	10.0 [3.74] ↗	6.9 [5.22] ↘	7.1 [6.27] ↖	8.2 [7.60] ↖	9.4 [8.77] ↘
Serie 5:	8.2 [4.11] ↗	9.8 [5.09] ↗	7.5 [6.51] ↖	10.5* [7.50] ↖	6.8 [9.06] ↙
Serie 6:	8.4 [3.41] ↗	8.6 [4.37] ↙	7.1 [5.57] ↙	6.6 [7.58] ↙	10.3 [8.60] ↖
Serie 7:	9.1 [3.65] ↗	10.0 [4.95] ↘	9.5 [6.72] ↖	10.4* [7.74] ↙	8.1 [8.92] ↗
Serie 8:	10.2 [3.57] ↗	6.1 [4.89] ↙	7.5 [6.04] ↖	8.3 [7.25] ↖	4.8 [8.52] ↖

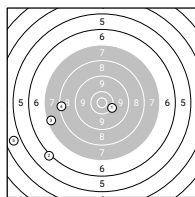
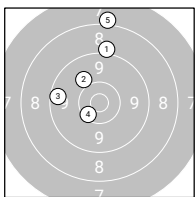
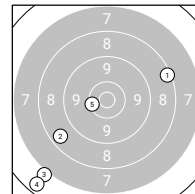
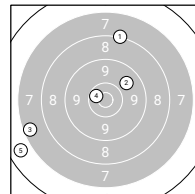
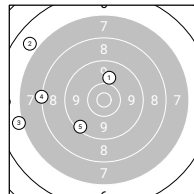
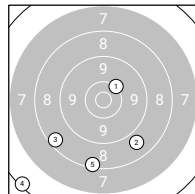
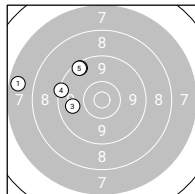
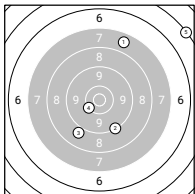

LP5 40 (S)

StandNr: 125

Gyarfas, Jozef #70818416

Senioren_1m

Wertung

StartNr: 173

28.02.2026 14:20

SG_Kramsach

SG Kramsach 1

Ergebnis: **337** (356.2)

Wertung: 337 Serien: 40 43 42 45 42 42 40 43

Zähler: 6 13 15 5 0 1 0 0 0 0 0

Innenzehner: 2

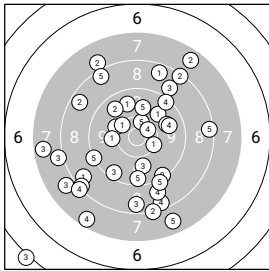

Wertung

Wertung

Serie 1:	10.1 [4.41] ↙	9.3 [5.29] ↘	5.1 [6.48] ↘	8.5 [7.29] ↘	8.4 [8.22] →
Serie 2:	9.9 [3.47] ↗	8.3 [4.50] ↗	9.4 [5.37] ↘	7.5 [6.33] ↘	10.4* [7.31] ↗
Serie 3:	10.1 [3.11] ←	8.0 [4.25] ↘	8.1 [5.26] ←	8.9 [6.30] ↘	8.5 [7.24] ↘
Serie 4:	9.7 [3.91] ↗	8.6 [5.21] ↘	9.9 [6.17] ↘	10.5* [7.22] ↗	9.1 [8.24] ↘
Serie 5:	8.6 [3.71] ↘	9.7 [4.90] ↘	7.6 [6.12] ←	9.8 [7.09] ↗	9.9 [8.08] ↗
Serie 6:	8.5 [3.90] ↗	8.2 [4.89] ↘	8.6 [5.98] ↘	9.7 [7.01] →	9.5 [7.96] ↘
Serie 7:	10.3 [4.19] ↗	8.3 [5.16] ↘	7.9 [6.45] ↘	8.2 [7.36] ↘	7.7 [8.35] ↘
Serie 8:	10.3 [4.93] ↘	7.6 [6.06] ↗	8.9 [7.31] ↗	9.4 [8.39] ↗	9.2 [9.33] ←

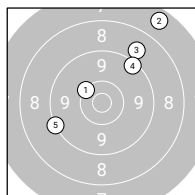
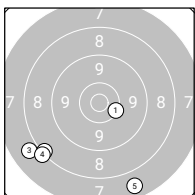
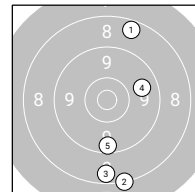
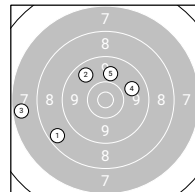
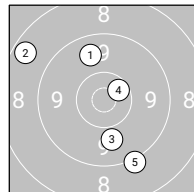
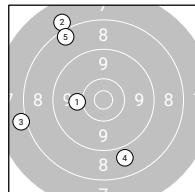
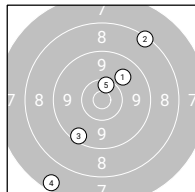
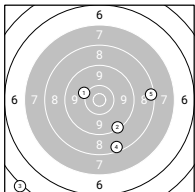

LP5 40 (S)

StandNr: 129

Sailer, Wilfried-- #70819145

Senioren_1m

Wertung

StartNr: 175

28.02.2026 14:20

SG_Hall

SG Hall 1

Ergebnis: **348** (369.0)

Wertung: 348 Serien: 47 44 45 40 40 45 44 43

Zähler: 9 17 8 5 1 0 0 0 0 0 0

Innenzehner: 5

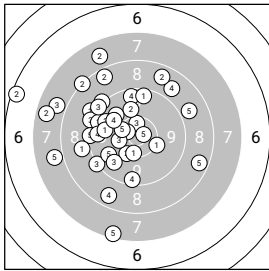

Wertung

Wertung

Serie 1:	10.2 [4.62] ➔	10.3 [5.88] ↘	10.5* [6.85] ↑	10.6* [7.48] ↙	7.4 [8.22] ↘
Serie 2:	9.2 [5.41] ↙	7.8 [6.13] ↙	10.3 [6.97] ←	8.8 [7.71] ↗	10.4* [8.27] ↙
Serie 3:	9.1 [4.87] ↙	8.2 [5.61] ↙	9.2 [6.32] ←	9.9 [7.01] ↙	10.7* [7.69] ➔
Serie 4:	9.5 [5.22] ↙	6.4 [6.08] ↙	7.9 [6.83] ←	9.5 [7.59] ↑	9.3 [8.28] ←
Serie 5:	9.5 [4.12] ↑	7.6 [5.32] ←	9.2 [6.38] ←	8.6 [7.19] ↘	7.9 [7.87] ←
Serie 6:	8.9 [5.45] ←	10.0 [6.20] ↑	9.7 [6.89] ↙	9.4 [7.73] ↓	9.8 [8.50] ←
Serie 7:	10.4* [5.75] ↘	8.7 [6.56] ↗	9.7 [7.28] ↙	9.5 [7.96] ←	8.6 [8.61] ➔
Serie 8:	9.8 [3.74] ←	8.5 [4.84] ↙	9.2 [5.73] ↙	9.9 [6.49] ↙	8.9 [7.50] ➔

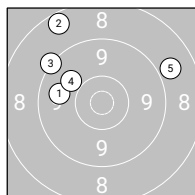
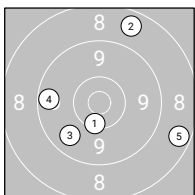
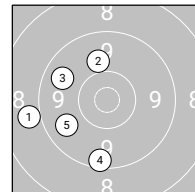
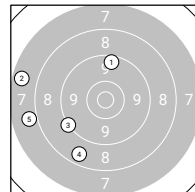
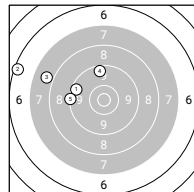
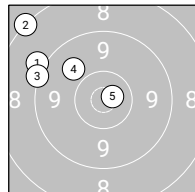
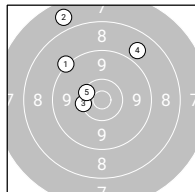
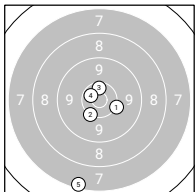

Ergebnis: **349** (368.1)

Wertung: 349 Serien: 44 43 44 38 48 47 44 41

Zähler: 11 16 6 5 2 0 0 0 0 0 0

Innenzehner: 3

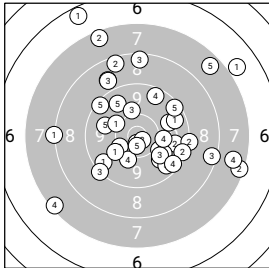

Wertung

Wertung

Serie 1:	9.5 [4.66] ↙	9.7 [6.25] ➔	8.4 [7.14] ➔	10.1 [7.98] ➤	8.9 [8.95] ↗
Serie 2:	9.8 [4.83] ➔	8.5 [6.09] ↗	8.4 [7.02] ↗	9.5 [7.81] ↗	9.9 [8.72] ➤
Serie 3:	8.2 [3.81] ↙	7.5 [5.25] ↗	10.3 [6.15] ↙	10.1 [7.29] ↘	9.8 [8.12] ↙
Serie 4:	6.9 [5.36] ➔	7.4 [6.26] ➔	9.6 [7.34] ➤	7.7 [8.20] ➔	9.7 [9.12] ↗
Serie 5:	10.1 [4.66] ↙	9.9 [5.48] ➤	10.1 [6.63] ↗	10.7* [7.62] ↘	9.4 [8.54] ↙
Serie 6:	10.0 [5.50] ↙	10.7* [6.29] ➤	10.0 [7.09] ➤	7.4 [7.84] ↙	10.6* [8.55] ↘
Serie 7:	9.6 [5.52] ➔	9.2 [6.82] ➔	9.2 [7.41] ↙	10.1 [8.22] ➔	7.6 [9.07] ↗
Serie 8:	6.5 [5.91] ↙	9.4 [6.53] ➔	8.9 [7.45] ↙	9.4 [8.18] ➤	9.4 [8.87] ➔

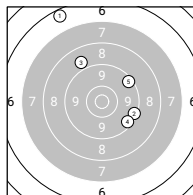
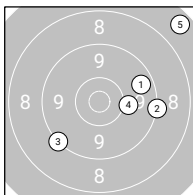
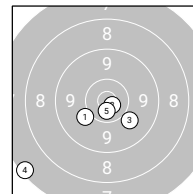
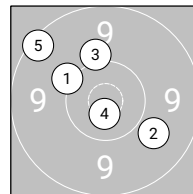
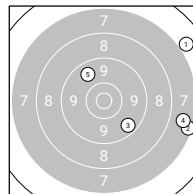
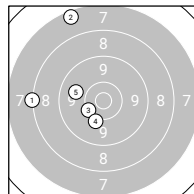
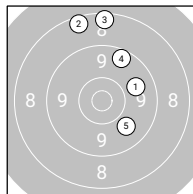
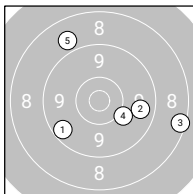

Ergebnis: **297** (314.6)

Wertung: 297 Serien: 30 38 45 44 29 42 29 40

Zähler: 4 11 8 9 4 0 1 1 0 0 2

Innenzehner: 2

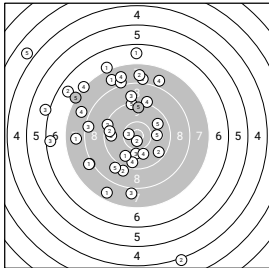

Wertung

Wertung

Serie 1:	7.8 [4.75] ↗	4.1 [6.28] ↘	8.0 [8.10] ↓	8.1 [8.96] ↗	3.8 [9.94] ↖
Serie 2:	7.8 [4.42] ←	9.6 [5.46] ↘	6.0 [6.51] ←	7.8 [7.52] ↗	9.6 [8.53] ←
Serie 3:	7.6 [4.20] ↘	9.3 [5.53] ←	10.0 [7.08] ↓	10.0 [8.08] ↓	9.3 [9.12] ↗
Serie 4:	8.1 [5.49] ←	10.7* [6.65] ↓	8.0 [7.89] ↗	9.1 [8.80] ↗	9.7 [9.91] ↘
Serie 5:	7.1 [5.07] ↗	9.5 [6.46] ←	6.5 [7.85] ←	7.9 [8.96] ↗	0.0+ _{AST,OOT} ↗
Serie 6:	6.7 [4.80] ↗	9.0 [6.25] ↘	10.5* [7.68] ←	9.6 [8.86] ↓	8.9 [9.64] ↘
Serie 7:	8.1 [5.27] ←	6.7 [6.59] ↖	8.4 [7.81] ←	7.8 [8.96] ←	0.0+ _{AST,OOT} ↖
Serie 8:	9.7 [4.91] ↘	7.8 [5.90] ↗	8.9 [7.14] ↗	7.2 [8.20] ↖	9.9 [9.99] →

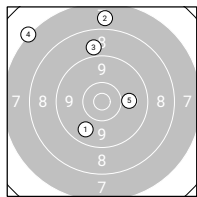
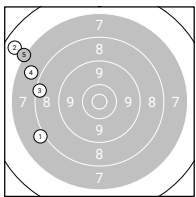
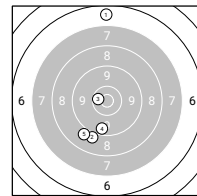
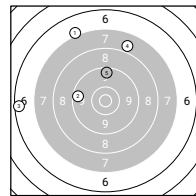
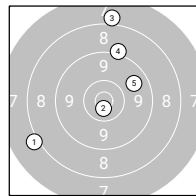
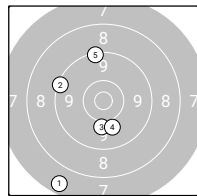
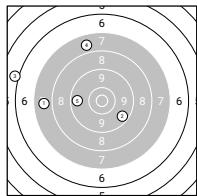
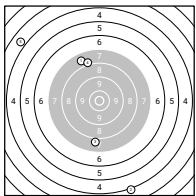

Fußnoten-Legende:

- AST** - Treffer wurde nach Ende der Schießzeit abgegeben
- OOT** - Treffer wurde außerhalb der Schießzeit abgegeben



Ergebnis: **338** (355.4)

Wertung: 338 Serien: 43 38 41 44 45 45 47 35

Zähler: 9 15 7 6 2 0 0 1 0 0 0

Innenzehner: 2

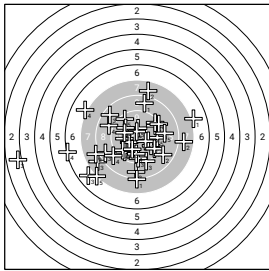

Wertung

Wertung

Serie 1:	8.7 [4.94] ↑	9.6 [5.96] ↗	7.9 [6.84] ↙	9.9 [7.61] ↘	10.1 [8.44] ←
Serie 2:	7.1 [4.62] →	7.9 [5.85] →	6.9 [6.70] ↙	9.0 [7.48] ↙	9.6 [8.11] →
Serie 3:	10.2 [3.98] ↘	7.9 [5.53] ↑	8.7 [6.48] ↘	7.1 [7.56] ↙	9.5 [8.41] ↗
Serie 4:	10.3 [4.93] ↙	10.3 [5.98] ↘	8.7 [6.88] ↓	9.7 [7.59] ↙	7.3 [8.45] ↙
Serie 5:	9.6 [5.04] ↘	8.9 [6.52] ↘	9.3 [7.49] ↓	9.7 [8.26] ↙	10.4* [9.09] ↑
Serie 6:	8.2 [5.36] ↓	10.0 [6.50] ↘	8.6 [7.44] ↙	9.0 [8.29] ↙	10.6* [9.22] ↑
Serie 7:	10.1 [5.23] ↙	9.5 [6.10] ↗	9.5 [6.83] ↓	9.8 [7.47] ↓	10.1 [8.21] ↙
Serie 8:	9.3 [5.90] ↗	8.0 [6.71] ↙	3.0 [7.28] ↙	6.3 [7.80] ↙	9.1 [8.56] →

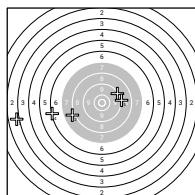
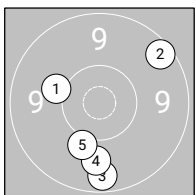
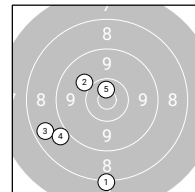
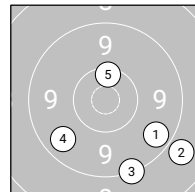
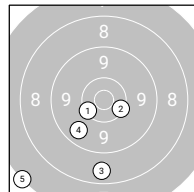
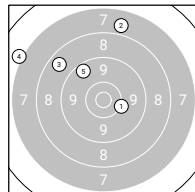
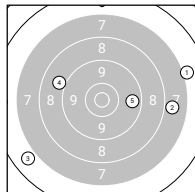
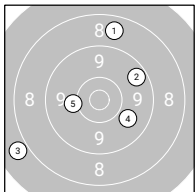

Ergebnis: **327** (340.5)

Wertung: 327 Serien: 41 39 42 44 34 47 42 38

Zähler: 6 12 13 6 1 1 0 0 1 0 0

Innenzehner: 1

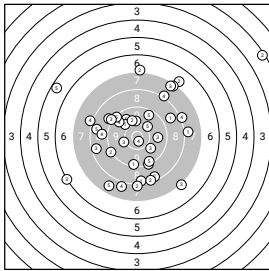

Wertung

Wertung

Serie 1:	8.0 [5.09] →	8.5 [5.85] ↓	8.5 [6.69] ←	8.1 [8.00] ↗	9.8 [8.79] ↖
Serie 2:	8.4 [4.75] ↓	8.1 [5.41] ↓	6.2 [6.70] ←	9.0 [7.81] ↖	8.6 [8.57] ←
Serie 3:	10.0 [2.75] ↖	7.0 [4.52] ↗	9.8 [5.70] →	9.6 [6.76] ↖	7.7 [8.24] ↓
Serie 4:	9.4 [3.77] ↓	9.2 [5.17] ↖	9.9 [6.02] ↓	8.1 [6.96] ↗	9.3 [8.07] ↖
Serie 5:	9.3 [4.75] ↓	2.4 [5.57] ↗	10.1 [6.70] ←	8.1 [7.68] ←	5.5 [8.58] ↖
Serie 6:	10.0 [4.82] ↑	10.0 [5.62] ↑	7.2 [6.76] ↓	10.7* [7.71] ↓	10.1 [8.87] ↗
Serie 7:	8.7 [4.50] ↗	8.3 [5.62] ↓	9.2 [6.83] ↖	8.9 [8.08] ←	9.4 [8.89] ↓
Serie 8:	7.4 [3.89] ↗	7.1 [5.40] ↑	7.4 [6.28] ↗	8.0 [7.31] ↓	9.5 [8.57] ↗

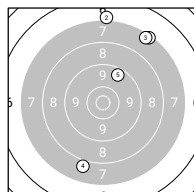
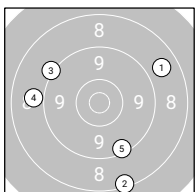
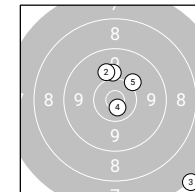
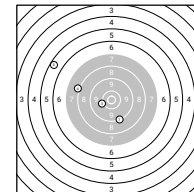
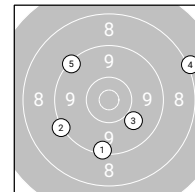
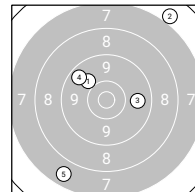
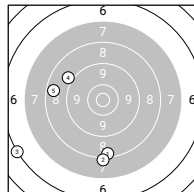
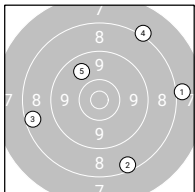

LP5 40 (S)

StandNr: 131

Sailer, Rudolf #70818615

Senioren_1m

Wertung

StartNr: 184

28.02.2026 14:20

SG_Hall

SG Hall 1

Ergebnis: **359** (377.1)

Wertung: 359 Serien: 42 45 46 47 44 46 44 45

Zähler: 13 16 9 1 1 0 0 0 0 0

Innenzehner: 6

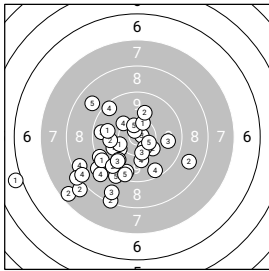

Wertung

Wertung

Serie 1:	6.0 [5.14] ←	7.5 [5.94] ↙	10.8* [6.73] →	10.0 [7.54] ↓	9.3 [8.23] ↙
Serie 2:	10.1 [4.26] ↙	8.0 [5.08] ↙	9.6 [5.85] ←	9.0 [6.59] ↙	9.2 [7.24] ↙
Serie 3:	9.9 [4.93] ↙	10.2 [5.89] ↘	9.6 [6.71] ↓	9.5 [7.48] ↓	9.4 [8.11] ↓
Serie 4:	10.2 [4.83] ↙	8.3 [5.66] ↘	9.8 [6.46] →	10.2 [7.31] ↘	10.7* [8.03] ↗
Serie 5:	9.8 [5.55] ↘	9.9 [6.20] ←	8.6 [7.02] ↓	8.9 [7.69] ↙	10.5* [8.42] ↗
Serie 6:	10.4* [4.58] ↗	10.0 [5.29] ↗	10.5* [6.24] ↓	8.5 [6.97] ↙	8.2 [7.75] ↙
Serie 7:	9.3 [4.62] ↙	9.5 [5.52] ↙	10.3 [6.37] ↓	8.4 [7.25] ↙	8.8 [8.01] ↘
Serie 8:	9.8 [3.71] ←	8.7 [4.47] ↘	9.8 [5.22] ↙	9.4 [6.01] ↘	10.5* [6.71] ↘

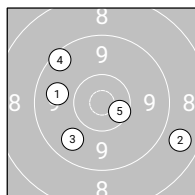
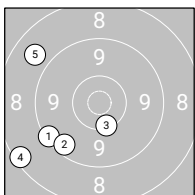
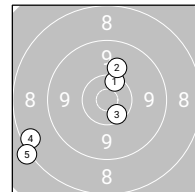
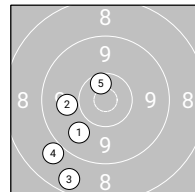
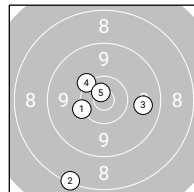
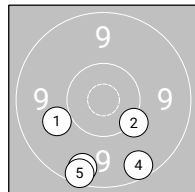
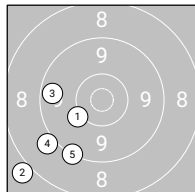
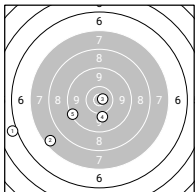

Ergebnis: **304** (322.5)

Wertung: 304 Serien: 37 35 39 43 38 38 34 40

Zähler: 3 9 11 7 6 4 0 0 0 0 0

Innenzehner: 0

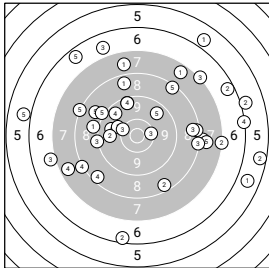

Wertung

Wertung

Serie 1:	8.1 [5.19] →	6.4 [6.18] ↓	9.2 [7.05] ←	6.3 [8.21] →	8.9 [9.26] ↖
Serie 2:	9.0 [4.12] ←	6.0 [5.71] →	6.8 [6.69] ↗	9.8 [7.55] ←	5.9 [8.36] ←
Serie 3:	10.0 [4.01] ↖	8.5 [5.20] ↘	7.2 [6.26] ↗	8.5 [7.09] ↘	6.6 [8.38] ↗
Serie 4:	8.6 [3.92] ↗	9.5 [5.02] ↗	10.3 [5.97] →	8.2 [7.06] ←	8.4 [8.03] ↗
Serie 5:	5.9 [5.89] ↗	9.8 [6.56] ←	7.0 [7.11] ←	8.4 [7.85] →	9.1 [8.48] ↖
Serie 6:	7.8 [4.04] ↗	5.5 [5.37] →	10.3 [6.63] ←	9.6 [7.58] ↖	7.9 [8.63] →
Serie 7:	5.8 [4.86] →	6.5 [6.37] →	8.3 [7.15] →	7.6 [7.81] ↖	8.2 [8.45] ↖
Serie 8:	7.6 [4.76] ↗	7.3 [6.75] →	8.5 [7.67] →	9.5 [9.16] ↗	9.7 [9.70] ↗

