

LG 40 ZR

StandNr: 113

Rudig, Kathrin #70819255

Frauen

Wertung

StartNr: 106

01.03.2026 12:46

SG_Zams

SG Zams 2

Ergebnis: **411.9 (394)**
 Serien: 102.1 103.3 104.9 101.6
 Zähler: 34 6 0 0 0 0 0 0 0 0 0
 Innenzehner: 28
 Weitest: 364 (18.), 354 (37.), 329 (34.)
 beste Teiler: 46.6 (12.), 64.0 (26.), 67.6 (17.)
 Trefferkreis: 11.40 mm
 Trefferlage: 0.16 mm rechts, 0.04 mm tief

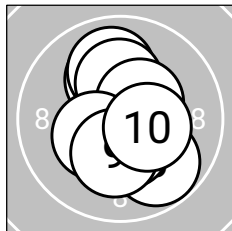
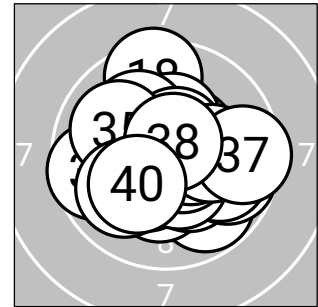
**Serie 1: 102.1 (99)**

10.1↑ 10.0↑ 10.2*↑ 10.3*↘ 10.4*↗
 9.8↘ 10.4*↓ 10.3*↙ 10.2*↓ 10.4*↘

beste Teiler: 128.5 (5.), 133.8 (7.), 144.5 (10.)
 Trefferkreis: 9.67 mm
 Trefferlage: 0.28 mm rechts, 0.08 mm tief

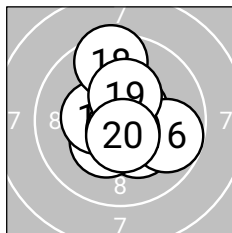
**Serie 2: 103.3 (98)**

10.3*↘ 10.8*↘ 10.6*↗ 10.3*↙ 10.4*↖
 9.8↘ 10.7*↓ 9.5↑ 10.3*↑ 10.6*↓

beste Teiler: 46.6 (12.), 67.6 (17.), 89.0 (13.)
 Trefferkreis: 10.24 mm
 Trefferlage: 0.28 mm rechts, 0.06 mm hoch

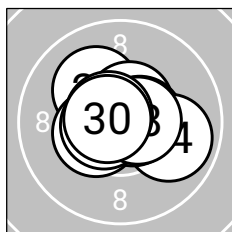
**Serie 3: 104.9 (99)**

10.1↖ 10.6*↗ 10.6*→ 9.9↘ 10.4*↖
 10.7*→ 10.6*↖ 10.6*→ 10.7*↖ 10.7*↖

beste Teiler: 64.0 (26.), 68.8 (30.), 69.1 (29.)
 Trefferkreis: 8.97 mm
 Trefferlage: 0.09 mm rechts, 0.17 mm hoch

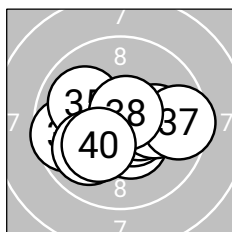
**Serie 4: 101.6 (98)**

10.4*↘ 10.6*↘ 10.5*→ 9.6↖ 10.0↖
 10.1→ 9.5→ 10.7*↗ 10.0↖ 10.2*↖

beste Teiler: 68.9 (38.), 85.8 (32.), 115.0 (33.)
 Trefferkreis: 11.30 mm
 Trefferlage: 0.01 mm links, 0.32 mm tief

Ergebnis: 421.5 (400)
Serien: 105.9 104.6 105.9 105.1
Zähler: 40 0 0 0 0 0 0 0 0 0 0
Innenzehner: 39
Weiteste: 224 (10.), 196 (11.), 178 (33.)
beste Teiler: 15.5 (21.), 42.0 (23.), 42.4 (8.)
Trefferkreis: 8.35 mm
Trefferlage: 0.16 mm links, 0.05 mm hoch

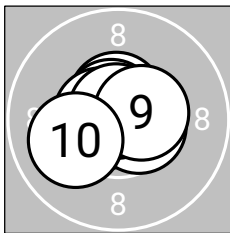
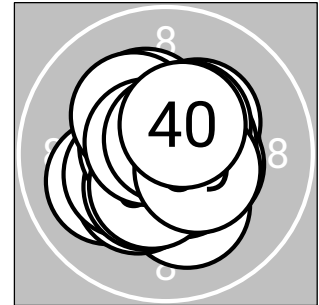

Serie 1: 105.9 (100)

10.6*↑ 10.7*→ 10.7*→ 10.7*← 10.7*↖
 10.6*↖ 10.5*→ 10.8*↑ 10.5*→ 10.1↖

beste Teiler: 42.4 (8.), 53.6 (3.), 66.7 (4.)
Trefferkreis: 7.89 mm
Trefferlage: 0.07 mm links, 0.12 mm hoch

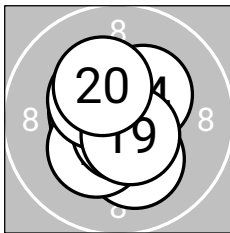

Serie 2: 104.6 (100)

10.2*↓ 10.6*↖ 10.6*← 10.3*↗ 10.6*↖
 10.3*↖ 10.7*↓ 10.4*↖ 10.6*↓ 10.3*↖

beste Teiler: 55.7 (17.), 86.2 (13.), 86.8 (12.)
Trefferkreis: 8.13 mm
Trefferlage: 0.26 mm links, 0.00 mm

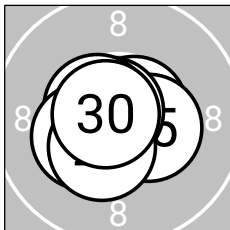

Serie 3: 105.9 (100)

10.9*→ 10.6*↗ 10.8*← 10.4*↖ 10.4*→
 10.8*↖ 10.6*↖ 10.3*← 10.4*↖ 10.7*↖

beste Teiler: 15.5 (21.), 42.0 (23.), 48.7 (26.)
Trefferkreis: 7.18 mm
Trefferlage: 0.31 mm links, 0.18 mm tief

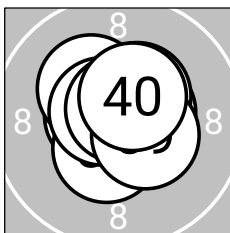

Serie 4: 105.1 (100)

10.5*→ 10.6*↖ 10.2*↖ 10.7*↖ 10.4*↗
 10.5*↓ 10.6*↖ 10.7*↑ 10.4*→ 10.5*↗

beste Teiler: 54.1 (38.), 56.0 (34.), 77.9 (37.)
Trefferkreis: 7.50 mm
Trefferlage: 0.00 mm , 0.30 mm hoch



LG 40 ZR

StandNr: 115

Kaplenig, Barbara #70819071**Frauen**

Wertung

StartNr: 108

01.03.2026 12:36

SG_Wattens-Rettenberg

Ergebnis: **414.9** (398)
 Serien: 103.5 103.1 104.1 104.2
 Zähler: 38 2 0 0 0 0 0 0 0 0
 Innenzehner: 29
 Weitester: 308 (2.), 278 (30.), 248 (36.)
 beste Teiler: 31.0 (9.), 32.7 (26.), 52.6 (17.)
 Trefferkreis: 9.59 mm
 Trefferlage: 0.48 mm links, 0.17 mm hoch

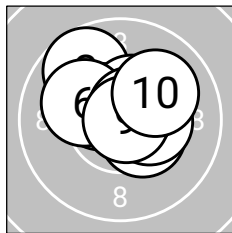
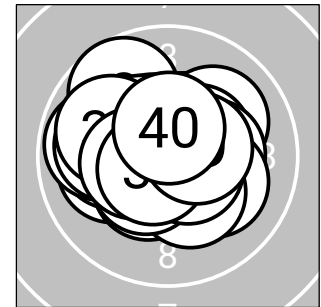
**Serie 1: 103.5** (99)

10.6*↖	9.7↖	10.5*↖	10.4*↗	10.4*↘
10.1↖	10.3*↗	10.7*↗	10.8*↗	10.0↗

beste Teiler: 31.0 (9.), 75.9 (8.), 97.6 (1.)
 Trefferkreis: 8.88 mm
 Trefferlage: 0.06 mm rechts, 0.69 mm hoch

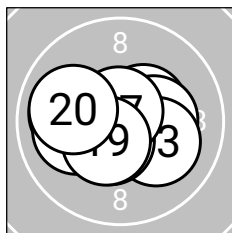
**Serie 2: 103.1** (100)

10.4*↗	10.3*↗	10.1↘	10.5*↖	10.5*↘
10.0↖	10.7*↗	10.1↖	10.5*↘	10.0↖

beste Teiler: 52.6 (17.), 110.0 (15.), 122.4 (14.)
 Trefferkreis: 9.01 mm
 Trefferlage: 0.48 mm links, 0.11 mm tief

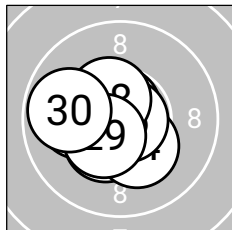
**Serie 3: 104.1** (99)

10.4*↘	10.7*↘	10.4*↖	10.3*↘	10.7*↗
10.8*↗	10.1↖	10.5*↖	10.4*↘	9.8↖

beste Teiler: 32.7 (26.), 55.4 (25.), 69.5 (22.)
 Trefferkreis: 8.62 mm
 Trefferlage: 0.79 mm links, 0.15 mm tief

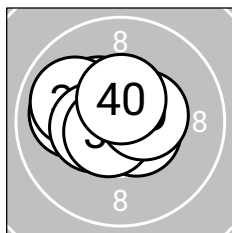
**Serie 4: 104.2** (100)

10.0↖	10.4*↖	10.7*↖	10.6*↘	10.5*↖
10.0↖	10.4*↖	10.6*↖	10.5*↗	10.5*↗

beste Teiler: 73.0 (33.), 79.3 (38.), 94.6 (34.)
 Trefferkreis: 8.03 mm
 Trefferlage: 0.71 mm links, 0.26 mm hoch

Ergebnis: **414.9** (397)
 Serien: 102.8 105.3 103.1 103.7
 Zähler: 37 3 0 0 0 0 0 0 0 0
 Innenzehner: 32
 Weitester: 324 (9.), 278 (22.), 260 (8.)
 beste Teiler: 2.2 (17.), 36.6 (2.), 44.8 (36.)
 Trefferkreis: 10.43 mm
 Trefferlage: 0.63 mm links, 0.00 mm

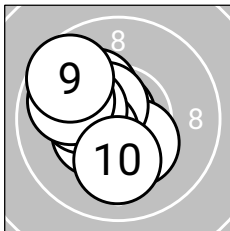
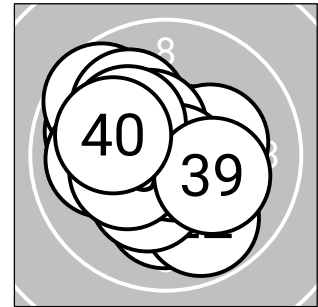

Serie 1: 102.8 (98)

10.6*↖	10.8*↖	10.3*↘	10.2*↖	10.6*↖
10.4*↖	10.2*↖	9.9↖	9.7↖	10.1↓

beste Teiler: 36.6 (2.), 93.6 (1.), 98.3 (5.)
 Trefferkreis: 9.37 mm
 Trefferlage: 1.00 mm links, 0.22 mm hoch

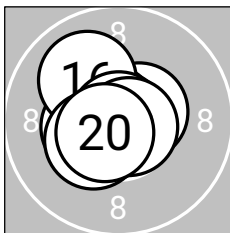

Serie 2: 105.3 (100)

10.5*↖	10.5*↘	10.4*↖	10.6*↖	10.7*↖
10.0↖	10.9*↘	10.4*↖	10.7*↘	10.6*↖

beste Teiler: 2.2 (17.), 51.6 (15.), 55.5 (19.)
 Trefferkreis: 7.59 mm
 Trefferlage: 0.51 mm links, 0.04 mm hoch

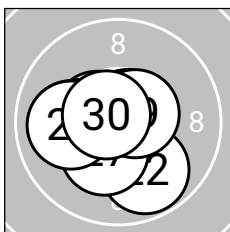

Serie 3: 103.1 (99)

10.0↖	9.8↘	10.5*↖	10.7*↘	10.2*↖
10.3*↖	10.3*↘	10.0↖	10.6*↘	10.7*↖

beste Teiler: 65.1 (24.), 71.3 (30.), 96.1 (29.)
 Trefferkreis: 8.91 mm
 Trefferlage: 0.81 mm links, 0.30 mm tief

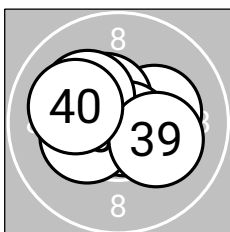

Serie 4: 103.7 (100)

10.4*↖	10.3*↘	10.2*↘	10.5*↖	10.7*↖
10.8*↘	10.2*↖	10.3*↖	10.2*↘	10.1↖

beste Teiler: 44.8 (36.), 59.0 (35.), 124.3 (34.)
 Trefferkreis: 8.65 mm
 Trefferlage: 0.20 mm links, 0.05 mm hoch



Ergebnis: 422.9 (400)
Serien: 106.2 106.5 105.1 105.1
Zähler: 40 0 0 0 0 0 0 0 0 0 0
Innenzehner: 38
Weiteste: 224 (34.), 215 (22.), 153 (40.)
beste Teiler: 37.9 (16.), 38.2 (31.), 39.6 (6.)
Trefferkreis: 8.18 mm
Trefferlage: 0.17 mm links, 0.03 mm hoch

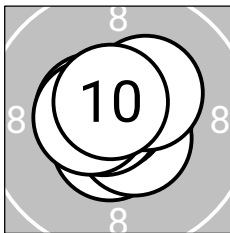
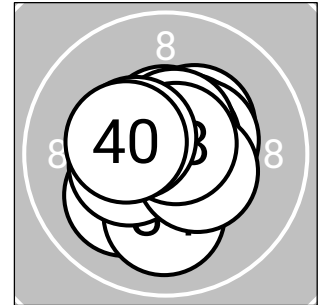

Serie 1: 106.2 (100)

10.8*↙	10.6*↓	10.7*→	10.6*↘	10.5*↖
10.8*↘	10.7*↖	10.4*↗	10.5*↖	10.6*↘

beste Teiler: 39.6 (6.), 41.5 (1.), 57.4 (7.)
Trefferkreis: 6.98 mm
Trefferlage: 0.16 mm links, 0.06 mm hoch

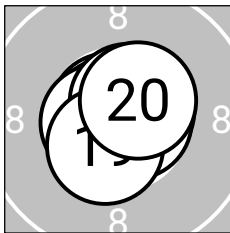

Serie 2: 106.5 (100)

10.7*↗	10.6*↗	10.7*→	10.7*→	10.8*↘
10.8*↖	10.6*↖	10.6*↗	10.5*↓	10.5*↗

beste Teiler: 37.9 (16.), 49.0 (15.), 55.0 (11.)
Trefferkreis: 6.66 mm
Trefferlage: 0.13 mm rechts, 0.15 mm hoch

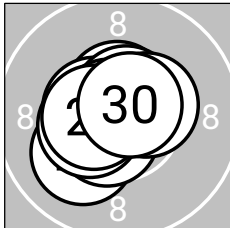

Serie 3: 105.1 (100)

10.5*↑	10.1*↙	10.5*↖	10.6*↗	10.8*↘
10.6*↘	10.4*↗	10.4*↖	10.5*↖	10.7*↗

beste Teiler: 46.3 (25.), 72.1 (30.), 87.9 (26.)
Trefferkreis: 7.91 mm
Trefferlage: 0.37 mm links, 0.08 mm hoch

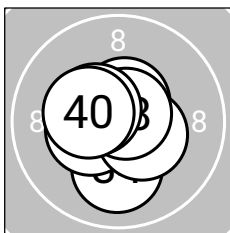

Serie 4: 105.1 (100)

10.8*↘	10.6*↙	10.8*↓	10.1↓	10.4*↖
10.6*↗	10.4*↘	10.7*↗	10.4*↖	10.3*↖

beste Teiler: 38.2 (31.), 43.9 (33.), 54.4 (38.)
Trefferkreis: 7.76 mm
Trefferlage: 0.29 mm links, 0.15 mm tief



LG 40 ZR

StandNr: 118

Gugglberger, Christa #70819257**Frauen**

Wertung

StartNr: 111

01.03.2026 12:42

SG_Westendorf

SG Westendorf 1

Ergebnis: **416.1** (395)
 Serien: 105.6 104.1 103.1 103.3
 Zähler: 35 5 0 0 0 0 0 0 0 0 0
 Innenzehner: 33
 Weitester: 425 (33.), 394 (28.), 286 (35.)
 beste Teiler: 18.9 (32.), 39.2 (7.), 47.0 (40.)
 Trefferkreis: 12.69 mm
 Trefferlage: 0.18 mm links, 0.27 mm tief

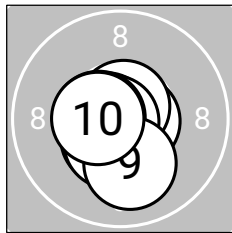
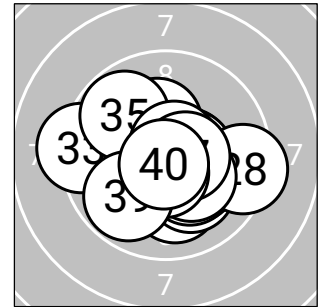
**Serie 1: 105.6** (100)

10.6*↘ 10.7*→ 10.5*↙ 10.7*↑ 10.5*↘
 10.7*← 10.8*← 10.5*← 10.1↓ 10.5*←

beste Teiler: 39.2 (7.), 62.0 (4.), 66.9 (2.)
 Trefferkreis: 7.33 mm
 Trefferlage: 0.26 mm links, 0.44 mm tief

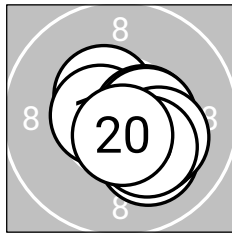
**Serie 2: 104.1** (100)

10.1↘ 10.5*↖ 10.5*↘ 10.6*← 10.5*→
 10.2*↘ 10.5*→ 10.2*→ 10.3*↘ 10.7*↓

beste Teiler: 75.6 (20.), 90.0 (14.), 105.6 (15.)
 Trefferkreis: 7.82 mm
 Trefferlage: 0.71 mm rechts, 0.50 mm tief

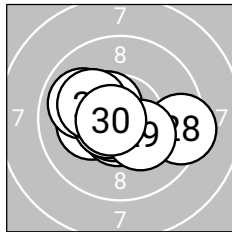
**Serie 3: 103.1** (98)

10.5*↖ 10.2*← 10.6*↓ 10.7*↙ 9.9←
 10.6*← 10.2*← 9.4→ 10.3*↘ 10.7*←

beste Teiler: 61.6 (30.), 62.2 (24.), 80.2 (26.)
 Trefferkreis: 10.97 mm
 Trefferlage: 0.35 mm links, 0.13 mm tief

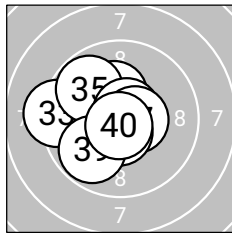
**Serie 4: 103.3** (97)

10.3*↑ 10.9*↘ 9.3← 10.5*↙ 9.8↖
 10.7*↗ 10.6*→ 10.6*↓ 9.8↙ 10.8*↓

beste Teiler: 18.9 (32.), 47.0 (40.), 63.0 (36.)
 Trefferkreis: 9.74 mm
 Trefferlage: 0.82 mm links, 0.00 mm

Ergebnis: 414.8 (392)
Serien: 104.2 103.9 102.6 104.1
Zähler: 33 6 1 0 0 0 0 0 0 0
Innenzehner: 31
Weiteste: 537 (9.), 338 (26.), 313 (23.)
beste Teiler: 36.0 (4.), 43.1 (3.), 43.4 (14.)
Trefferkreis: 13.23 mm
Trefferlage: 0.12 mm links, 0.29 mm tief

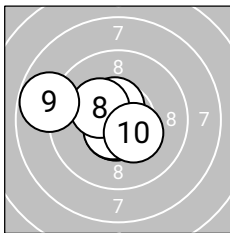
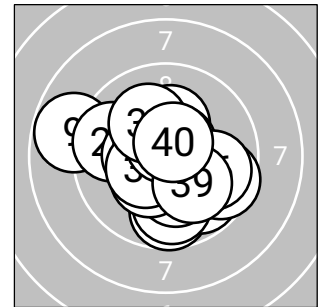

Serie 1: 104.2 (98)

10.6* \downarrow 10.8* \swarrow 10.8* \swarrow 10.8* \leftarrow 10.6* \downarrow
 10.6* \downarrow 10.6* \uparrow 10.3* \swarrow 8.8 \leftarrow 10.3* \swarrow

beste Teiler: 36.0 (4.), 43.1 (3.), 47.2 (2.)
Trefferkreis: 11.27 mm
Trefferlage: 0.76 mm links, 0.07 mm tief

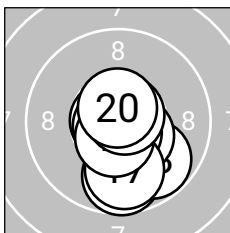

Serie 2: 103.9 (97)

10.7* \leftarrow 9.7 \downarrow 9.8 \swarrow 10.8* \swarrow 10.5* \swarrow
 10.7* \downarrow 9.8 \downarrow 10.6* \downarrow 10.7* \nearrow 10.6* \uparrow

beste Teiler: 43.4 (14.), 51.2 (11.), 51.6 (19.)
Trefferkreis: 8.37 mm
Trefferlage: 0.28 mm rechts, 0.94 mm tief

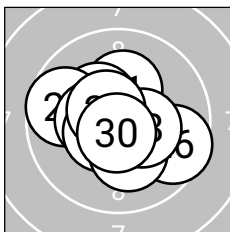

Serie 3: 102.6 (98)

10.2* \uparrow 10.3* \swarrow 9.7 \leftarrow 10.4* \leftarrow 10.5* \swarrow
 9.6 \rightarrow 10.2* \downarrow 10.4* \rightarrow 10.6* \swarrow 10.7* \downarrow

beste Teiler: 68.7 (30.), 94.1 (29.), 111.2 (25.)
Trefferkreis: 11.00 mm
Trefferlage: 0.19 mm links, 0.04 mm tief

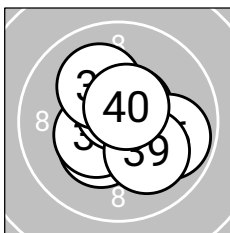

Serie 4: 104.1 (99)

10.7* \swarrow 10.6* \nearrow 10.7* \downarrow 10.3* \swarrow 10.4* \swarrow
 9.9 \rightarrow 10.7* \uparrow 10.1 \swarrow 10.1 \swarrow 10.6* \nearrow

beste Teiler: 55.4 (33.), 64.2 (31.), 72.0 (37.)
Trefferkreis: 8.99 mm
Trefferlage: 0.17 mm rechts, 0.13 mm tief



Ergebnis: **420.8** (399)
 Serien: 104.7 105.6 105.2 105.3
 Zähler: 39 1 0 0 0 0 0 0 0 0
 Innenzehner: 38
 Weitester: 318 (24.), 237 (4.), 190 (5.)
 beste Teiler: 8.6 (32.), 24.0 (25.), 31.1 (13.)
 Trefferkreis: 9.46 mm
 Trefferlage: 0.11 mm links, 0.12 mm tief

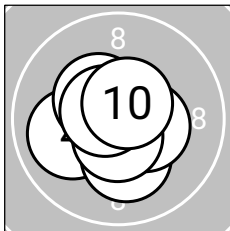
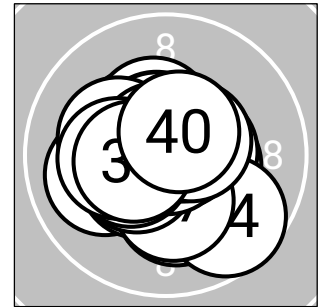

Serie 1: 104.7 (100)
 10.5*↖ 10.7*↗ 10.6*↓ 10.0← 10.2*↓
 10.4*→ 10.6*↓ 10.4*↖ 10.7*↖ 10.6*↗
 beste Teiler: 54.5 (2.), 75.8 (9.), 86.0 (7.)
 Trefferkreis: 8.09 mm
 Trefferlage: 0.22 mm links, 0.30 mm tief

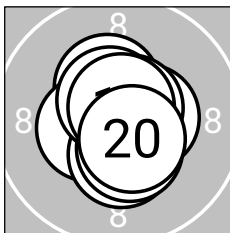

Serie 2: 105.6 (100)
 10.4*↖ 10.5*→ 10.8*↓ 10.5*← 10.4*↓
 10.6*↖ 10.7*↗ 10.4*↓ 10.7*↑ 10.6*↘
 beste Teiler: 31.1 (13.), 58.2 (19.), 72.1 (17.)
 Trefferkreis: 7.38 mm
 Trefferlage: 0.09 mm rechts, 0.05 mm tief

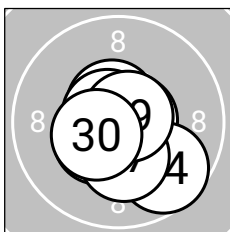

Serie 3: 105.2 (99)
 10.6*↖ 10.7*↓ 10.7*→ 9.7↘ 10.9*↑
 10.4*↖ 10.3*↓ 10.7*↖ 10.7*↗ 10.5*↖
 beste Teiler: 24.0 (25.), 54.7 (29.), 65.4 (28.)
 Trefferkreis: 8.52 mm
 Trefferlage: 0.07 mm rechts, 0.42 mm tief

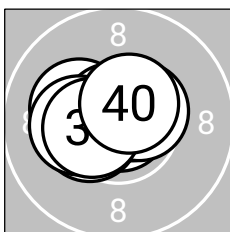

Serie 4: 105.3 (100)
 10.2*↖ 10.9*↗ 10.4*← 10.7*↗ 10.7*↖
 10.2*↖ 10.6*↗ 10.5*↗ 10.5*← 10.6*↗
 beste Teiler: 8.6 (32.), 54.0 (35.), 68.6 (34.)
 Trefferkreis: 7.31 mm
 Trefferlage: 0.39 mm links, 0.28 mm hoch



LG 40 ZR

StandNr: 121

Weiskopf, Sabine #70819259

Frauen

Wertung

StartNr: 114

01.03.2026 12:38

SG_Bruckhäusl

SG Bruckhäusl 1

Ergebnis: **421.4 (400)**
 Serien: 104.7 105.1 105.2 106.4
 Zähler: 40 0 0 0 0 0 0 0 0 0 0
 Innenzehner: 38
 Weitest: 230 (23.), 203 (9.), 200 (17.)
 beste Teiler: 11.1 (14.), 38.3 (38.), 40.3 (12.)
 Trefferkreis: 8.62 mm
 Trefferlage: 0.16 mm rechts, 0.29 mm hoch

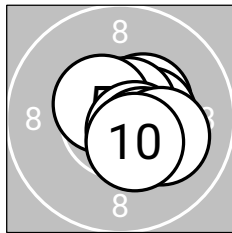
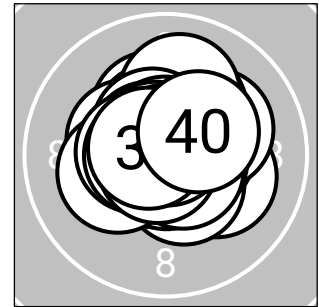
**Serie 1: 104.7 (100)**

10.7*↗	10.4*↗	10.4*↗	10.7*↗	10.5*↖
10.5*↘	10.6*↘	10.4*↘	10.1*↘	10.4*↘

beste Teiler: 66.2 (4.), 68.6 (1.), 85.4 (7.)
 Trefferkreis: 7.60 mm
 Trefferlage: 0.72 mm rechts, 0.15 mm tief

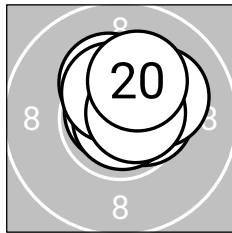
**Serie 2: 105.1 (100)**

10.5*→	10.8*↖	10.4*↑	10.9*↘	10.6*↗
10.3*↖	10.2*↗	10.5*↖	10.7*↗	10.2*↗

beste Teiler: 11.1 (14.), 40.3 (12.), 73.7 (19.)
 Trefferkreis: 6.90 mm
 Trefferlage: 0.40 mm rechts, 0.81 mm hoch

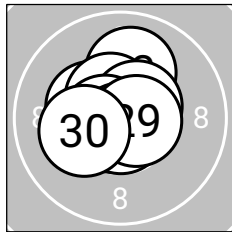
**Serie 3: 105.2 (100)**

10.7*↙	10.8*↑	10.0↑	10.3*↖	10.5*↖
10.6*↗	10.7*↖	10.8*↓	10.6*↗	10.2*↖

beste Teiler: 41.5 (22.), 50.0 (28.), 58.7 (21.)
 Trefferkreis: 8.18 mm
 Trefferlage: 0.26 mm links, 0.29 mm hoch

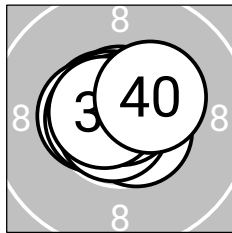
**Serie 4: 106.4 (100)**

10.6*↘	10.6*↖	10.5*↖	10.7*↑	10.6*↖
10.7*↖	10.8*↙	10.8*↑	10.7*↖	10.4*↗

beste Teiler: 38.3 (38.), 40.3 (37.), 60.0 (36.)
 Trefferkreis: 6.93 mm
 Trefferlage: 0.19 mm links, 0.25 mm hoch

LG 40 ZR

StandNr: 122

Urdl, Fernanda #70819181

Frauen

Wertung

StartNr: 115

01.03.2026 12:39

SG_Angerberg

SG Angerberg 1

Ergebnis: **416.5** (399)
 Serien: 103.5 103.9 104.9 104.2
 Zähler: 39 1 0 0 0 0 0 0 0 0
 Innenzehner: 33
 Weitest: 253 (19.), 247 (37.), 240 (22.)
 beste Teiler: 31.1 (36.), 50.4 (21.), 53.9 (27.)
 Trefferkreis: 9.23 mm
 Trefferlage: 0.08 mm links, 0.25 mm tief

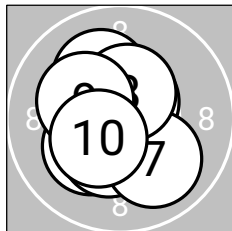
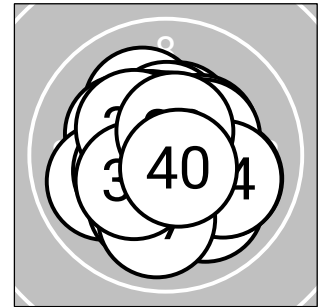
**Serie 1: 103.5** (100)

10.1 ↗ 10.6* ↗ 10.6* ↖ 10.2* ↖ 10.5* ↓
 10.4* ↘ 10.0 ↘ 10.5* ↑ 10.2* ↖ 10.4* ↖

beste Teiler: 86.0 (3.), 91.9 (2.), 116.1 (5.)
 Trefferkreis: 8.95 mm
 Trefferlage: 0.35 mm links, 0.25 mm tief

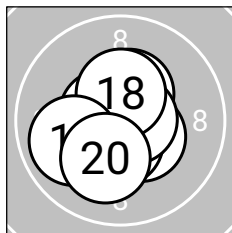
**Serie 2: 103.9** (99)

10.2* ↖ 10.4* ↘ 10.7* ↓ 10.6* ↖ 10.5* ↓
 10.4* ↗ 10.7* → 10.4* ↑ 9.9 ↖ 10.1 ↘

beste Teiler: 61.2 (17.), 70.0 (13.), 86.7 (14.)
 Trefferkreis: 8.21 mm
 Trefferlage: 0.30 mm links, 0.37 mm tief

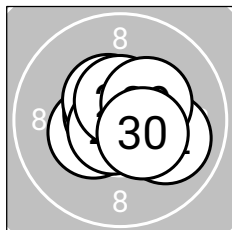
**Serie 3: 104.9** (100)

10.8* ↖ 10.0 → 10.4* ↖ 10.7* ↖ 10.5* ↘ 10.5* ↖
 10.7* ↖ 10.6* ↑ 10.3* ↗ 10.4* ↘

beste Teiler: 50.4 (21.), 53.9 (27.), 62.7 (24.)
 Trefferkreis: 8.11 mm
 Trefferlage: 0.23 mm rechts, 0.03 mm tief

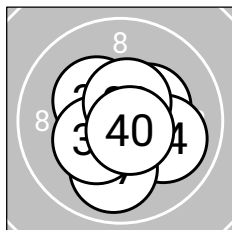
**Serie 4: 104.2** (100)

10.7* ↓ 10.3* → 10.5* ↖ 10.0 → 10.3* ↖
 10.8* ↓ 10.0 ↓ 10.3* ↖ 10.6* ↗ 10.7* ↘

beste Teiler: 31.1 (36.), 63.5 (31.), 70.0 (40.)
 Trefferkreis: 8.61 mm
 Trefferlage: 0.06 mm rechts, 0.36 mm tief

Ergebnis: 419.7 (398)
Serien: 105.3 105.8 104.3 104.3
Zähler: 38 2 0 0 0 0 0 0 0 0
Innenzehner: 35
Weiteste: 354 (40.), 293 (29.), 242 (7.)
beste Teiler: 8.9 (13.), 16.0 (9.), 28.1 (8.)
Trefferkreis: 10.31 mm
Trefferlage: 0.03 mm links, 0.00 mm

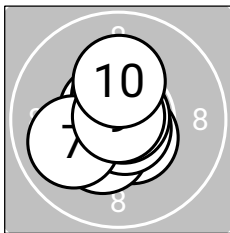
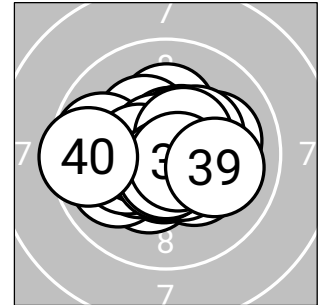

Serie 1: 105.3 (100)

10.5*↘	10.6*↖	10.8*↑	10.3*↙	10.5*↑
10.7*↘	10.0↙	10.8*↗	10.9*↑	10.2*↑

beste Teiler: 16.0 (9.), 28.1 (8.), 37.2 (3.)
Trefferkreis: 8.23 mm
Trefferlage: 0.23 mm links, 0.03 mm hoch

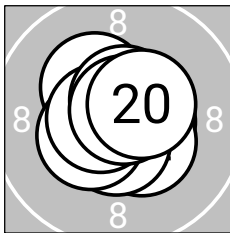

Serie 2: 105.8 (100)

10.6*→	10.4*↘	10.9*↖	10.6*↓	10.3*↖
10.4*↙	10.7*←	10.6*↑	10.8*↗	10.5*↗

beste Teiler: 8.9 (13.), 44.7 (19.), 73.1 (17.)
Trefferkreis: 7.49 mm
Trefferlage: 0.03 mm rechts, 0.07 mm hoch

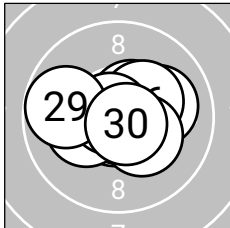

Serie 3: 104.3 (99)

10.1→	10.8*↙	10.8*↓	10.2*←	10.5*↗
10.3*↗	10.8*↖	10.3*↘	9.8←	10.7*↘

beste Teiler: 34.5 (23.), 48.4 (27.), 49.7 (22.)
Trefferkreis: 9.52 mm
Trefferlage: 0.07 mm rechts, 0.03 mm hoch

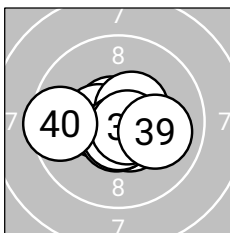

Serie 4: 104.3 (99)

10.6*↗	10.5*↘	10.7*↖	10.5*←	10.6*↓
10.5*↗	10.7*↓	10.7*↘	10.0→	9.5←

beste Teiler: 62.8 (33.), 65.1 (38.), 70.0 (37.)
Trefferkreis: 10.30 mm
Trefferlage: 0.01 mm links, 0.15 mm tief



Ergebnis: **416.3** (398)
 Serien: 104.6 102.7 104.6 104.4
 Zähler: 38 2 0 0 0 0 0 0 0 0
 Innenzehner: 33
 Weitestе: 273 (19.), 256 (25.), 245 (35.)
 beste Teiler: 30.4 (13.), 35.1 (27.), 36.1 (36.)
 Trefferkreis: 9.70 mm
 Trefferlage: 0.02 mm rechts, 0.22 mm hoch

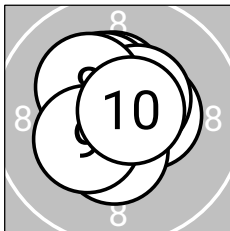
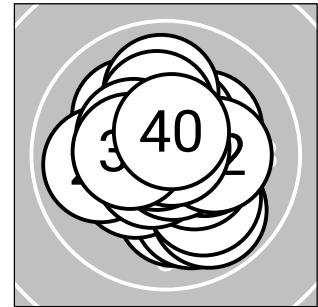

Serie 1: 104.6 (100)
 10.7*↖ 10.4*↑ 10.5*→ 10.3*↖ 10.6*↗
 10.5*↗ 10.4*↓ 10.2*↖ 10.3*↙ 10.7*↗
 beste Teiler: 63.5 (10.), 67.9 (1.), 80.5 (5.)
 Trefferkreis: 7.52 mm
 Trefferlage: 0.09 mm links, 0.46 mm hoch

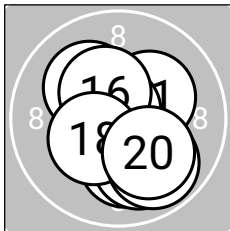

Serie 2: 102.7 (99)
 10.2*↗ 10.1↖ 10.8*↓ 10.8*↖ 10.1↓
 10.4*↖ 10.0↓ 10.3*↖ 9.9↘ 10.1↘
 beste Teiler: 30.4 (13.), 38.9 (14.), 142.6 (16.)
 Trefferkreis: 9.30 mm
 Trefferlage: 0.24 mm rechts, 0.51 mm tief

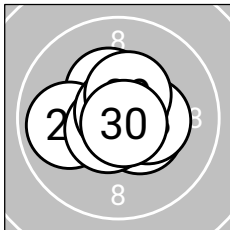

Serie 3: 104.6 (99)
 10.4*↘ 10.6*↙ 10.4*→ 10.4*↖ 9.9←
 10.6*↙ 10.8*↑ 10.3*→ 10.4*↗ 10.8*↘
 beste Teiler: 35.1 (27.), 40.3 (30.), 79.9 (26.)
 Trefferkreis: 8.57 mm
 Trefferlage: 0.02 mm rechts, 0.12 mm hoch

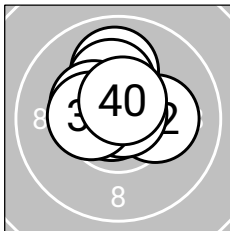

Serie 4: 104.4 (100)
 10.6*↗ 10.2*→ 10.8*↖ 10.4*↖ 10.0↑
 10.8*↗ 10.2*↑ 10.4*↖ 10.4*↙ 10.6*↗
 beste Teiler: 36.1 (36.), 36.6 (33.), 90.3 (31.)
 Trefferkreis: 8.04 mm
 Trefferlage: 0.08 mm links, 0.81 mm hoch



Ergebnis: **409.9** (394)
 Serien: 101.3 103.5 102.4 102.7
 Zähler: 34 6 0 0 0 0 0 0 0 0
 Innenzehner: 27
 Weitester: 453 (1.), 441 (30.), 318 (40.)
 beste Teiler: 46.3 (39.), 63.5 (20.), 75.1 (10.)
 Trefferkreis: 12.91 mm
 Trefferlage: 0.10 mm rechts, 0.36 mm hoch

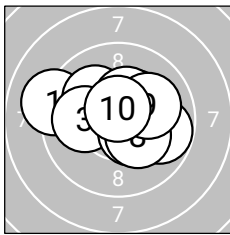
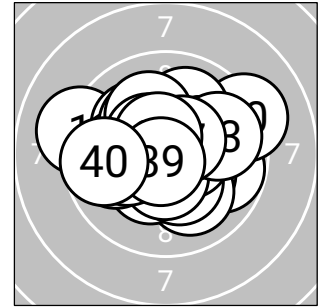

Serie 1: 101.3 (98)

9.1 ←	10.1 ↖	10.0 ←	10.3* ↗	9.8 →
10.4* ↗	10.5* ↘	10.3* ↘	10.1 ↗	10.7* ↑

beste Teiler: 75.1 (10.), 124.4 (7.), 147.6 (6.)
 Trefferkreis: 11.95 mm
 Trefferlage: 0.04 mm rechts, 0.42 mm hoch

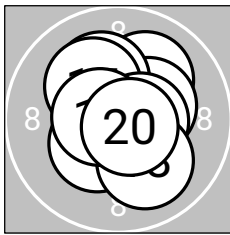

Serie 2: 103.5 (100)

10.1 ↗	10.3* ↗	10.5* ↘	10.2* ↖	10.2* ↖
10.5* →	10.4* ↙	10.0 ↘	10.6* ←	10.7* ↘

beste Teiler: 63.5 (20.), 85.7 (19.), 102.3 (16.)
 Trefferkreis: 8.75 mm
 Trefferlage: 0.23 mm rechts, 0.15 mm hoch

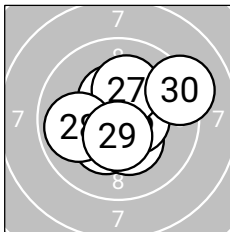

Serie 3: 102.4 (98)

10.3* ↙	10.5* →	10.6* ↑	10.4* ↑	10.3* ↘
10.5* →	10.2* ↑	9.9 ←	10.5* ↓	9.2 →

beste Teiler: 85.1 (23.), 109.0 (26.), 111.1 (29.)
 Trefferkreis: 11.48 mm
 Trefferlage: 0.33 mm rechts, 0.18 mm hoch

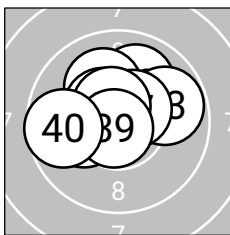

Serie 4: 102.7 (98)

10.5* ↗	10.0 ↗	9.8 →	10.2* ←	10.1 ↖
10.5* ↖	10.5* ↗	10.6* ↖	10.8* ↙	9.7 ←

beste Teiler: 46.3 (39.), 97.5 (38.), 109.7 (37.)
 Trefferkreis: 10.47 mm
 Trefferlage: 0.21 mm links, 0.71 mm hoch



Ergebnis: 403.1 (388)
Serien: 100.3 102.5 99.6 100.7
Zähler: 28 12 0 0 0 0 0 0 0 0
Innenzehner: 21
Weiteste: 469 (37.), 454 (8.), 441 (24.)
beste Teiler: 14.8 (32.), 33.3 (20.), 34.4 (12.)
Trefferkreis: 12.25 mm
Trefferlage: 1.22 mm rechts, 0.12 mm hoch

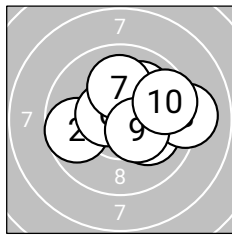
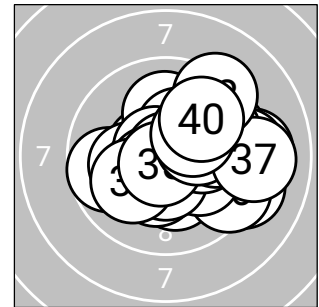

Serie 1: 100.3 (97)

10.3*↗ 9.7↖ 10.0↗ 10.5*↔ 10.1↘
 10.6*↖ 10.0↑ 9.1→ 10.4*↘ 9.6↗

beste Teiler: 97.5 (6.), 111.0 (4.), 138.2 (9.)
Trefferkreis: 12.13 mm
Trefferlage: 1.00 mm rechts, 0.50 mm hoch

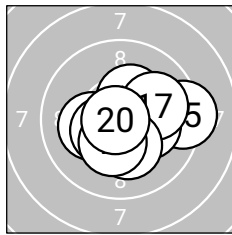

Serie 2: 102.5 (99)

10.2*↖ 10.8*↗ 10.3*↗ 10.4*↖ 9.3→
 10.2*↔ 10.0→ 10.2*↘ 10.3*↘ 10.8*↖

beste Teiler: 33.3 (20.), 34.4 (12.), 129.5 (14.)
Trefferkreis: 10.56 mm
Trefferlage: 0.56 mm rechts, 0.19 mm tief

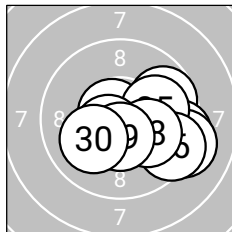

Serie 3: 99.6 (96)

9.7↗ 9.4↘ 10.7*↖ 9.2↘ 10.0→
 9.4↘ 10.5*↖ 10.1↘ 10.5*↓ 10.1↖

beste Teiler: 67.4 (23.), 102.9 (27.), 117.0 (29.)
Trefferkreis: 10.38 mm
Trefferlage: 1.50 mm rechts, 0.62 mm tief

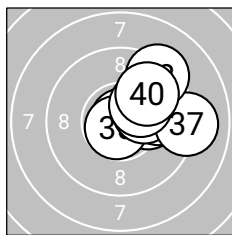

Serie 4: 100.7 (96)

10.3*↗ 10.9*↗ 10.2*↔ 9.8→ 10.8*↖
 10.2*↗ 9.1→ 9.3↗ 10.2*↗ 9.9↗

beste Teiler: 14.8 (32.), 49.9 (35.), 154.6 (31.)
Trefferkreis: 9.80 mm
Trefferlage: 1.83 mm rechts, 0.79 mm hoch



LG 40 ZR

StandNr: 127

Mair, Eva-Maria #70819070

Frauen

Wertung

StartNr: 120

01.03.2026 12:45

SG_Matrei_a._Br.

SG Matrei a. Br. 1

Ergebnis: **407.9** (390)
 Serien: 102.7 101.8 103.4 100.0
 Zähler: 31 8 1 0 0 0 0 0 0 0
 Innenzehner: 25
 Weitest: 501 (35.), 378 (15.), 338 (18.)
 beste Teiler: 25.0 (20.), 28.0 (29.), 44.7 (10.)
 Trefferkreis: 11.44 mm
 Trefferlage: 0.98 mm rechts, 0.06 mm tief

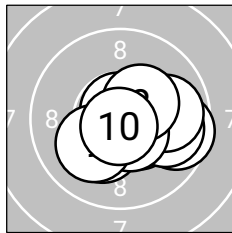
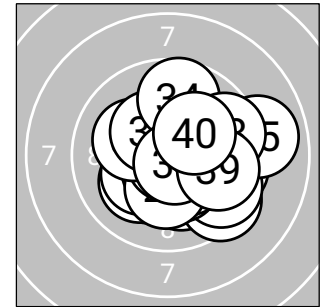
**Serie 1: 102.7** (97)

10.4*↘	9.6→	9.9→	10.2*↘	9.9→
10.8*↑	10.6*↘	10.4*↗	10.1↘	10.8*↓

beste Teiler: 44.7 (10.), 47.0 (6.), 99.6 (7.)
 Trefferkreis: 9.34 mm
 Trefferlage: 0.85 mm rechts, 0.44 mm tief

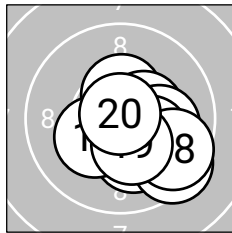
**Serie 2: 101.8** (98)

10.2*↘	10.4*↑	10.3*↘	10.4*→	9.4↘
10.1→	10.2*↘	9.6→	10.3*↘	10.9*↑

beste Teiler: 25.0 (20.), 131.2 (12.), 134.4 (14.)
 Trefferkreis: 9.34 mm
 Trefferlage: 1.08 mm rechts, 0.78 mm tief

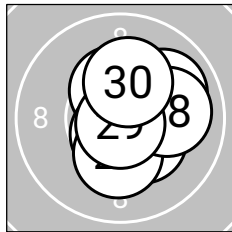
**Serie 3: 103.4** (100)

10.4*↑	10.3*↗	10.6*↘	10.6*↘	10.0↗
10.3*↘	10.2*↓	10.0→	10.8*↓	10.2*↑

beste Teiler: 28.0 (29.), 83.2 (23.), 84.7 (24.)
 Trefferkreis: 8.31 mm
 Trefferlage: 0.64 mm rechts, 0.15 mm hoch

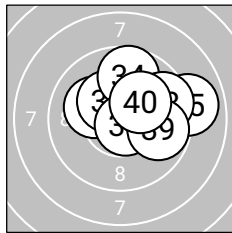
**Serie 4: 100.0** (95)

10.1↘	10.6*→	10.3*↘	9.7↑	8.9→
10.7*↘	10.1→	9.6→	9.8→	10.2*↗

beste Teiler: 58.1 (36.), 84.3 (32.), 157.0 (33.)
 Trefferkreis: 11.28 mm
 Trefferlage: 1.33 mm rechts, 0.81 mm hoch



Ergebnis: 419.4 (399)
Serien: 104.3 105.8 104.3 105.0
Zähler: 39 1 0 0 0 0 0 0 0 0
Innenzehner: 39
Weiteste: 261 (21.), 200 (5.), 191 (38.)
beste Teiler: 25.5 (15.), 42.4 (22.), 48.0 (36.)
Trefferkreis: 8.94 mm
Trefferlage: 0.13 mm rechts, 0.19 mm hoch

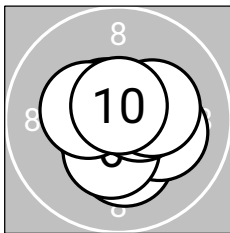
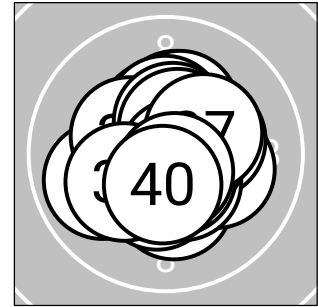

Serie 1: 104.3 (100)

10.6*↖	10.7*↖	10.3*↗	10.2*↓	10.2*↗
10.4*↓	10.5*↗	10.4*↖	10.3*↗	10.7*↑

beste Teiler: 65.0 (10.), 75.4 (2.), 82.0 (1.)
Trefferkreis: 7.98 mm
Trefferlage: 0.34 mm rechts, 0.23 mm tief

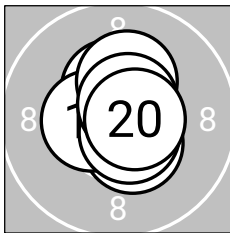

Serie 2: 105.8 (100)

10.6*↗	10.7*↗	10.4*↑	10.5*↘	10.9*↘
10.5*↖	10.3*↑	10.6*↘	10.6*↗	10.7*↗

beste Teiler: 25.5 (15.), 62.3 (12.), 74.0 (20.)
Trefferkreis: 7.34 mm
Trefferlage: 0.22 mm rechts, 0.29 mm hoch

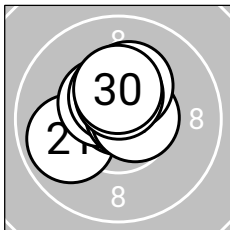

Serie 3: 104.3 (99)

9.9↖	10.8*↑	10.5*↖	10.5*↑	10.3*↗
10.7*↗	10.6*↗	10.2*↑	10.5*↑	10.3*↑

beste Teiler: 42.4 (22.), 61.7 (26.), 86.2 (27.)
Trefferkreis: 8.51 mm
Trefferlage: 0.10 mm links, 0.76 mm hoch

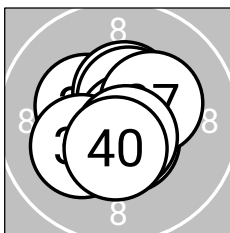

Serie 4: 105.0 (100)

10.7*↘	10.3*↖	10.6*↘	10.4*↑	10.5*↗
10.8*↗	10.3*↗	10.2*↖	10.7*↘	10.5*↓

beste Teiler: 48.0 (36.), 64.4 (31.), 75.5 (39.)
Trefferkreis: 8.07 mm
Trefferlage: 0.07 mm rechts, 0.05 mm tief



LG 40 ZR

StandNr: 129

Seelos, Julia #70819178

Frauen

Wertung

StartNr: 122

01.03.2026 12:45

SG_Imst

SG Imst 1

Ergebnis: **413.4** (397)
 Serien: 101.2 104.3 103.5 104.4
 Zähler: 37 3 0 0 0 0 0 0 0 0
 Innenzehner: 33
 Weitester: 370 (6.), 328 (9.), 322 (18.)
 beste Teiler: 5.6 (15.), 21.8 (37.), 58.0 (21.)
 Trefferkreis: 10.78 mm
 Trefferlage: 0.45 mm links, 0.24 mm tief

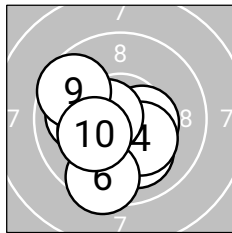
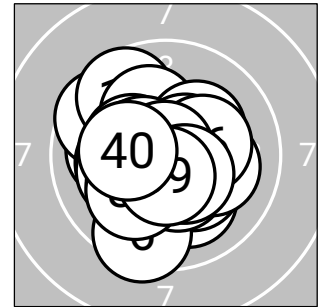
**Serie 1: 101.2** (98)

10.1 ↘ 10.2* ↘ 10.4* ➡ 10.3* ↘ 10.0 ←
 9.5 ↘ 10.3* ← 10.6* ← 9.6 ↘ 10.2* ←

beste Teiler: 87.6 (8.), 133.9 (3.), 169.5 (7.)
 Trefferkreis: 10.11 mm
 Trefferlage: 0.72 mm links, 0.81 mm tief

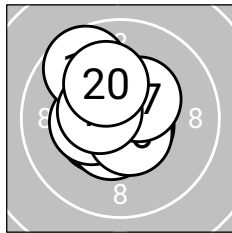
**Serie 2: 104.3** (99)

10.5* ← 10.5* ↘ 10.7* ➡ 10.3* ← 10.9* ↗
 10.6* ↘ 10.4* ↗ 9.7 ↘ 10.5* ← 10.2* ↘

beste Teiler: 5.6 (15.), 71.5 (13.), 91.2 (16.)
 Trefferkreis: 8.63 mm
 Trefferlage: 0.46 mm links, 0.29 mm hoch

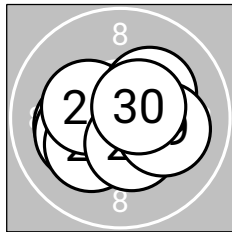
**Serie 3: 103.5** (100)

10.7* ➡ 10.7* ➡ 10.2* ← 10.2* ← 10.2* ↗
 10.3* ← 10.2* ↗ 10.4* ↘ 10.1 ➡ 10.5* ↗

beste Teiler: 58.0 (21.), 64.5 (22.), 103.2 (30.)
 Trefferkreis: 8.46 mm
 Trefferlage: 0.06 mm links, 0.24 mm tief

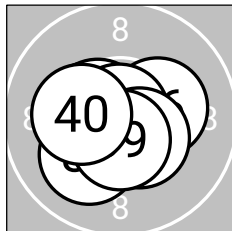
**Serie 4: 104.4** (100)

10.4* ← 10.4* ← 10.5* ← 10.4* ← 10.1 ↘
 10.3* ➡ 10.9* ↗ 10.5* ↘ 10.6* ↓ 10.3* ←

beste Teiler: 21.8 (37.), 95.0 (39.), 110.6 (33.)
 Trefferkreis: 8.24 mm
 Trefferlage: 0.56 mm links, 0.22 mm tief

LG 40 ZR

StandNr: 130

Götsch, Magdalena #70819263**Frauen**

Wertung

StartNr: 123

01.03.2026 12:34

SG_Haiming

SG Haiming 1

Ergebnis: **402.0** (384)
 Serien: 100.8 99.4 100.1 101.7
 Zähler: 24 16 0 0 0 0 0 0 0 0
 Innenzehner: 16
 Weitester: 463 (32.), 433 (21.), 418 (10.)
 beste Teiler: 63.3 (35.), 66.6 (3.), 73.5 (31.)
 Trefferkreis: 13.47 mm
 Trefferlage: 0.77 mm links, 0.12 mm tief

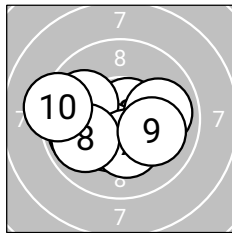
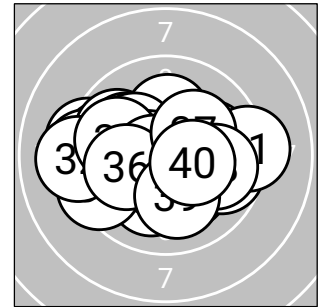
**Serie 1: 100.8** (95)

9.9 ← 10.4* ← 10.7* ↗ 10.4* ↘ 9.9 →
 9.9 ← 10.3* ↓ 9.9 ← 10.1 → 9.3 ←

beste Teiler: 66.6 (3.), 139.4 (4.), 141.5 (2.)
 Trefferkreis: 11.11 mm
 Trefferlage: 0.79 mm links, 0.31 mm tief

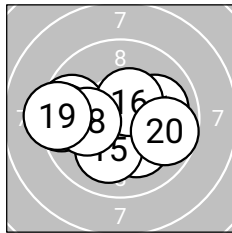
**Serie 2: 99.4** (96)

10.0 → 9.6 ← 10.2* ↘ 10.5* ↘ 10.1 ↘
 10.5* ↗ 9.4 ← 10.1 ← 9.3 ← 9.7 →

beste Teiler: 123.3 (14.), 124.4 (16.), 196.6 (13.)
 Trefferkreis: 11.69 mm
 Trefferlage: 0.81 mm links, 0.30 mm tief

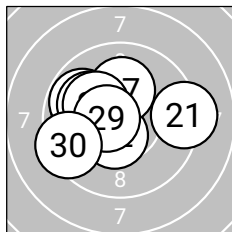
**Serie 3: 100.1** (96)

9.2 → 10.5* ↘ 9.9 ← 9.8 ← 10.0 ←
 10.4* ← 10.1 ↑ 10.2* ← 10.6* ← 9.4 ←

beste Teiler: 92.6 (29.), 110.7 (22.), 145.8 (26.)
 Trefferkreis: 12.59 mm
 Trefferlage: 1.04 mm links, 0.45 mm hoch

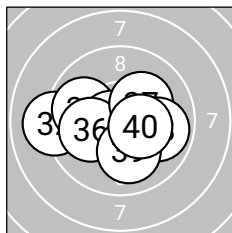
**Serie 4: 101.7** (97)

10.7* ↓ 9.1 ← 10.6* ↘ 9.9 ← 10.7* ←
 10.1 ← 10.2* ↗ 9.9 → 10.1 ↓ 10.4* →

beste Teiler: 63.3 (35.), 73.5 (31.), 86.8 (33.)
 Trefferkreis: 11.75 mm
 Trefferlage: 0.44 mm links, 0.35 mm tief



Ergebnis: **421.0** (399)
 Serien: 104.0 105.9 105.4 105.7
 Zähler: 39 1 0 0 0 0 0 0 0 0
 Innenzehner: 38
 Weitester: 269 (4.), 226 (10.), 183 (40.)
 beste Teiler: 30.0 (12.), 32.2 (27.), 38.4 (1.)
 Trefferkreis: 8.86 mm
 Trefferlage: 0.06 mm links, 0.09 mm hoch

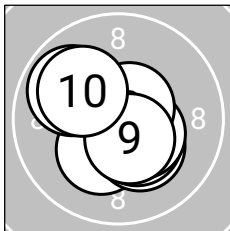
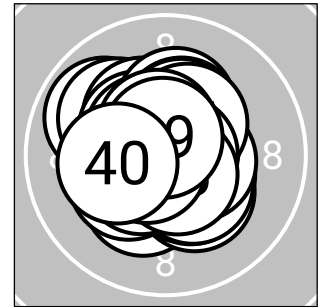

Serie 1: 104.0 (99)

10.8*↓	10.3*↖	10.8*↗	9.9↖	10.3*↘
10.4*↘	10.4*↘	10.6*↗	10.5*↘	10.0↖

beste Teiler: 38.4 (1.), 45.2 (3.), 78.4 (8.)
 Trefferkreis: 8.86 mm
 Trefferlage: 0.04 mm links, 0.24 mm tief

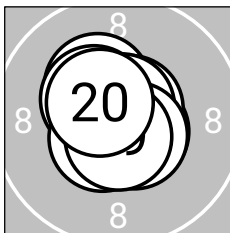

Serie 2: 105.9 (100)

10.3*↖	10.8*↗	10.4*↖	10.6*↘	10.6*↖
10.7*↗	10.7*↗	10.6*↘	10.7*↓	10.5*↖

beste Teiler: 30.0 (12.), 57.2 (17.), 68.0 (19.)
 Trefferkreis: 7.05 mm
 Trefferlage: 0.12 mm links, 0.18 mm hoch

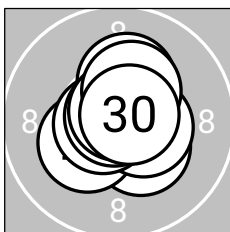

Serie 3: 105.4 (100)

10.4*↘	10.8*↖	10.3*↖	10.2*↑	10.5*↘
10.7*↖	10.8*↖	10.7*↑	10.3*↗	10.7*↗

beste Teiler: 32.2 (27.), 38.6 (22.), 51.0 (28.)
 Trefferkreis: 7.85 mm
 Trefferlage: 0.09 mm rechts, 0.20 mm hoch

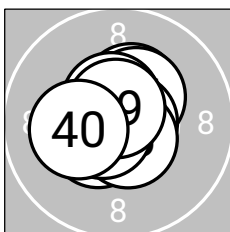

Serie 4: 105.7 (100)

10.8*↖	10.5*↖	10.4*↗	10.4*↗	10.8*↘
10.6*↘	10.6*↖	10.7*↖	10.7*↑	10.2*↖

beste Teiler: 39.0 (31.), 45.0 (35.), 66.0 (39.)
 Trefferkreis: 7.51 mm
 Trefferlage: 0.19 mm links, 0.21 mm hoch



LG 40 ZR

StandNr: 132

Neuhauser, Laura #70819180

Frauen

Wertung

StartNr: 125

01.03.2026 12:42

SG_Eben

SG Eben 2

Ergebnis: **415.8** (398)
 Serien: 103.4 104.1 104.2 104.1
 Zähler: 38 2 0 0 0 0 0 0 0 0
 Innenzehner: 31
 Weitest: 298 (26.), 252 (17.), 246 (9.)
 beste Teiler: 31.9 (36.), 52.0 (25.), 54.4 (37.)
 Trefferkreis: 9.51 mm
 Trefferlage: 0.01 mm rechts, 0.52 mm hoch

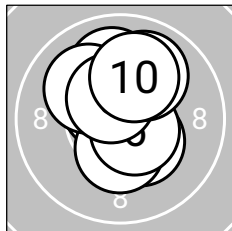
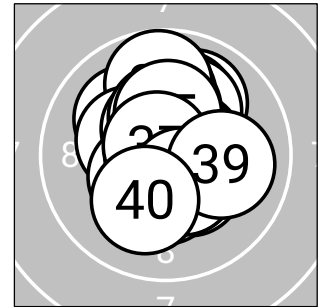
**Serie 1: 103.4** (100)

10.6*↖	10.4*↘	10.7*↑	10.0↑	10.4*↓
10.6*↘	10.1↖	10.5*↖	10.0↗	10.1↗

beste Teiler: 64.3 (3.), 93.2 (6.), 95.4 (1.)
 Trefferkreis: 8.47 mm
 Trefferlage: 0.04 mm rechts, 0.73 mm hoch

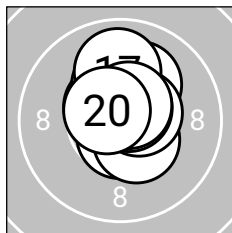
**Serie 2: 104.1** (99)

10.6*↓	10.6*↖	10.4*↘	10.1↗	10.2*↑
10.5*↗	9.9↑	10.6*↗	10.6*↗	10.6*↖

beste Teiler: 76.0 (11.), 77.6 (18.), 86.4 (20.)
 Trefferkreis: 8.14 mm
 Trefferlage: 0.17 mm rechts, 0.75 mm hoch

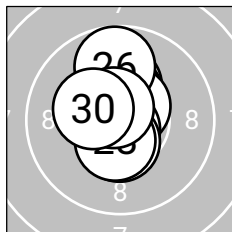
**Serie 3: 104.2** (99)

10.2*↑	10.4*↑	10.6*↖	10.6*↗	10.7*↓
9.8↑	10.5*↓	10.5*↓	10.6*↖	10.3*↖

beste Teiler: 52.0 (25.), 78.7 (29.), 94.1 (23.)
 Trefferkreis: 8.67 mm
 Trefferlage: 0.24 mm links, 0.63 mm hoch

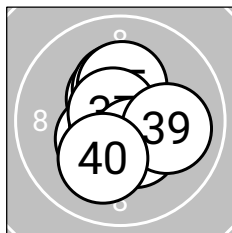
**Serie 4: 104.1** (100)

10.5*↑	10.3*↑	10.4*↖	10.6*↘	10.3*↑
10.8*↖	10.7*↖	10.4*↘	10.0↗	10.1↘

beste Teiler: 31.9 (36.), 54.4 (37.), 82.3 (34.)
 Trefferkreis: 8.51 mm
 Trefferlage: 0.06 mm rechts, 0.00 mm

Ergebnis: **414.8** (398)
 Serien: 102.7 103.2 104.3 104.6
 Zähler: 38 2 0 0 0 0 0 0 0 0
 Innenzehner: 32
 Weitester: 263 (10.), 254 (29.), 248 (12.)
 beste Teiler: 3.1 (36.), 44.5 (22.), 48.3 (32.)
 Trefferkreis: 9.45 mm
 Trefferlage: 0.23 mm links, 0.13 mm tief

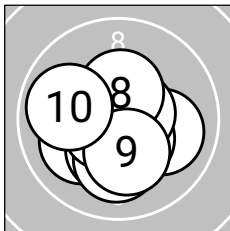
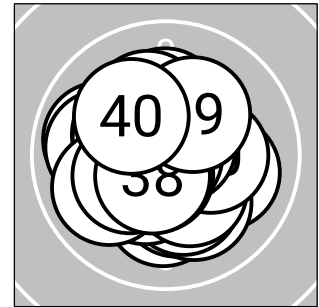

Serie 1: 102.7 (99)

10.1 ↙	10.0 →	10.3* ↘	10.5* ↘	10.1 ↓
10.6* ↙	10.6* →	10.4* ↑	10.2* ↘	9.9 ↙

beste Teiler: 78.5 (7.), 80.7 (6.), 123.9 (4.)
 Trefferkreis: 9.45 mm
 Trefferlage: 0.15 mm links, 0.64 mm tief

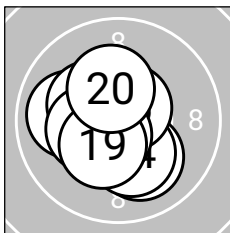

Serie 2: 103.2 (100)

10.4* ↓	10.0 ←	10.1 ↘	10.2* ↘	10.3* ↙
10.6* ↗	10.6* ↘	10.3* ↙	10.4* ↘	10.3* ↑

beste Teiler: 82.0 (16.), 91.8 (17.), 136.5 (11.)
 Trefferkreis: 8.74 mm
 Trefferlage: 0.44 mm links, 0.38 mm tief

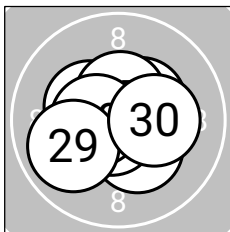

Serie 3: 104.3 (99)

10.3* ↙	10.8* ↘	10.4* ↗	10.3* ↘	10.7* ↗
10.7* ↘	10.5* ↑	10.5* ←	9.9 ↙	10.2* →

beste Teiler: 44.5 (22.), 55.0 (25.), 56.6 (26.)
 Trefferkreis: 8.67 mm
 Trefferlage: 0.05 mm links, 0.02 mm tief

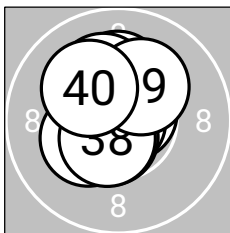

Serie 4: 104.6 (100)

10.3* ↙	10.8* ↑	10.2* ↑	10.7* ↗	10.2* ↖
10.9* ↙	10.6* ↘	10.6* ↘	10.2* ↗	10.1 ↘

beste Teiler: 3.1 (36.), 48.3 (32.), 62.8 (34.)
 Trefferkreis: 7.94 mm
 Trefferlage: 0.29 mm links, 0.53 mm hoch



Ergebnis: 414.4 (396)
Serien: 104.4 103.1 104.1 102.8
Zähler: 36 4 0 0 0 0 0 0 0 0
Innenzehner: 32
Weiteste: 475 (19.), 294 (28.), 255 (1.)
beste Teiler: 14.8 (23.), 42.1 (31.), 46.0 (2.)
Trefferkreis: 11.81 mm
Trefferlage: 0.27 mm links, 0.02 mm tief

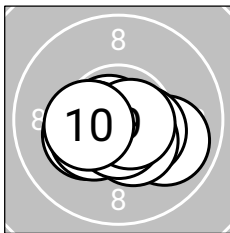
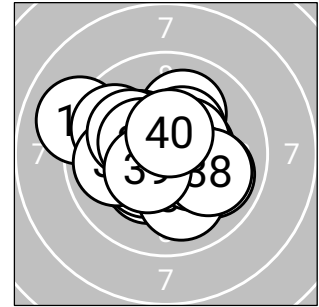

Serie 1: 104.4 (99)

9.9↘	10.8*←	10.3*←	10.4*→	10.4*←
10.4*↘	10.4*←	10.7*↓	10.7*→	10.4*←

beste Teiler: 46.0 (2.), 63.9 (9.), 70.0 (8.)
Trefferkreis: 8.40 mm
Trefferlage: 0.11 mm links, 0.57 mm tief

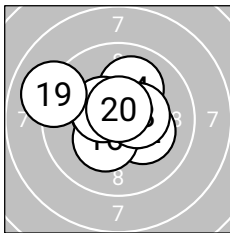

Serie 2: 103.1 (99)

10.7*↘	10.2*↘	10.5*←	10.1↗	10.6*→
10.3*↙	10.5*←	10.4*→	9.1←	10.7*↑

beste Teiler: 55.7 (11.), 70.1 (20.), 96.5 (15.)
Trefferkreis: 11.12 mm
Trefferlage: 0.21 mm links, 0.38 mm hoch

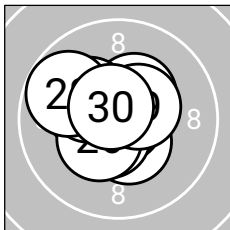

Serie 3: 104.1 (99)

10.4*↘	10.3*←	10.9*→	10.4*↗	10.5*↙
10.4*↙	10.2*←	9.8←	10.5*↗	10.7*↖

beste Teiler: 14.8 (23.), 74.9 (30.), 102.3 (25.)
Trefferkreis: 8.58 mm
Trefferlage: 0.50 mm links, 0.23 mm hoch

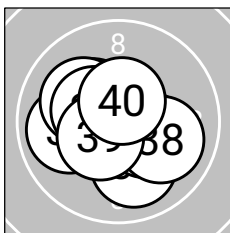

Serie 4: 102.8 (99)

10.8*→	10.3*←	9.9←	10.1←	10.0↓
10.3*→	10.4*←	10.0→	10.5*←	10.5*↑

beste Teiler: 42.1 (31.), 108.6 (40.), 121.3 (39.)
Trefferkreis: 9.24 mm
Trefferlage: 0.28 mm links, 0.12 mm tief

