

Ergebnis: **183.6** (177)
 Serien: 88.3 95.3
 Zähler: 6 7 5 2 0 0 0 0 0 0
 Innenzehner: 4
 Weitester: 989 (4.), 781 (2.), 707 (10.)
 beste Teiler: 80.9 (17.), 90.7 (7.), 133.0 (14.)
 Trefferkreis: 22.11 mm
 Trefferlage: 1.94 mm rechts, 0.59 mm tief

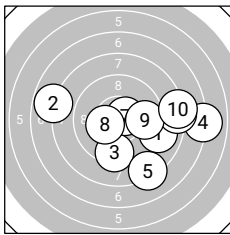
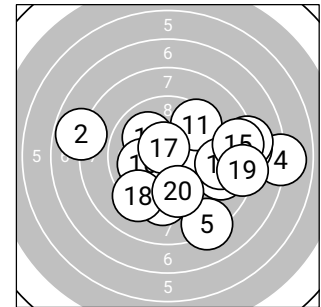

Serie 1: 88.3 (85)

9.0 →	7.8 ←	9.4 ↓	7.0 →	8.2 ↘
8.2 →	10.6* →	10.3* ←	9.7 →	8.1 →

beste Teiler: 90.7 (7.), 165.4 (8.), 310.0 (9.)
 Trefferkreis: 22.11 mm
 Trefferlage: 2.61 mm rechts, 0.80 mm tief

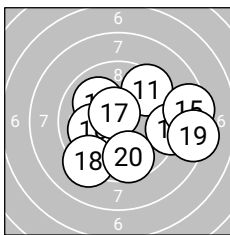

Serie 2: 95.3 (92)

9.5 ↗	9.1 →	10.0 ↘	10.4* ←	8.5 →
10.0 ←	10.6* ↗	9.2 ↘	8.3 →	9.7 ↓

beste Teiler: 80.9 (17.), 133.0 (14.), 228.6 (16.)
 Trefferkreis: 14.35 mm
 Trefferlage: 1.26 mm rechts, 0.38 mm tief



Ergebnis: **203.5** (192)
 Serien: 100.6 102.9
 Zähler: 13 6 1 0 0 0 0 0 0 0
 Innenzehner: 13
 Weitester: 538 (3.), 371 (2.), 333 (15.)
 beste Teiler: 33.5 (16.), 45.2 (13.), 51.0 (6.)
 Trefferkreis: 12.48 mm
 Trefferlage: 1.02 mm links, 0.07 mm tief

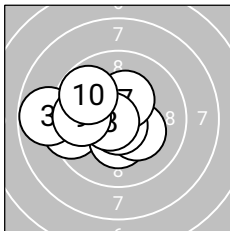
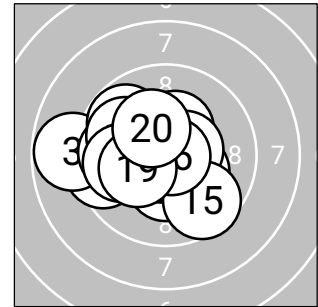

Serie 1: 100.6 (95)

10.4*↖	9.5↖	8.8↖	10.3*↓	10.3*↘
10.7*↓	10.3*↗	10.7*↖	9.8↖	9.8↖

beste Teiler: 51.0 (6.), 67.0 (8.), 149.8 (1.)
 Trefferkreis: 11.41 mm
 Trefferlage: 1.41 mm links, 0.03 mm hoch

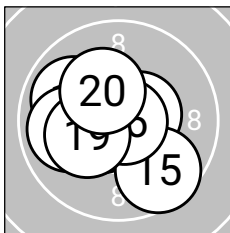

Serie 2: 102.9 (97)

10.4*↖	10.5*↖	10.8*↖	10.5*→	9.6↘
10.8*→	9.9↖	9.9↖	10.2*↖	10.3*↖

beste Teiler: 33.5 (16.), 45.2 (13.), 104.3 (12.)
 Trefferkreis: 10.29 mm
 Trefferlage: 0.64 mm links, 0.17 mm tief

Ergebnis: **185.1** (175)
 Serien: 93.1 92.0
 Zähler: 6 10 0 2 1 1 0 0 0 0 0
 Innenzehner: 3
 Weitester: 1431 (12.), 1194 (2.), 966 (19.)
 beste Teiler: 62.0 (7.), 160.5 (5.), 169.4 (17.)
 Trefferkreis: 30.75 mm
 Trefferlage: 1.23 mm links, 0.42 mm hoch

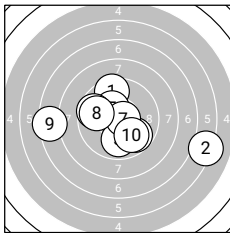
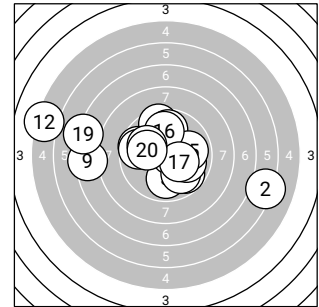

Serie 1: 93.1 (87)

9.5↑ 6.2➡ 9.9↓ 9.8➤ 10.3*↖
 9.6↙ 10.7*➡ 9.8↙ 7.4← 9.9➤

beste Teiler: 62.0 (7.), 160.5 (5.), 265.0 (3.)
 Trefferkreis: 24.94 mm
 Trefferlage: 0.06 mm links, 0.46 mm tief

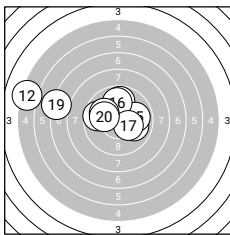

Serie 2: 92.0 (88)

9.7↙ 5.2↙ 10.0➡ 9.8↑ 9.9➡
 9.9↑ 10.3*➡ 10.0↙ 7.1← 10.1↙

beste Teiler: 169.4 (17.), 219.5 (20.), 241.0 (18.)
 Trefferkreis: 21.30 mm
 Trefferlage: 2.40 mm links, 1.30 mm hoch



Ergebnis: **175.4** (166)
 Serien: 88.1 87.3
 Zähler: 3 7 6 1 3 0 0 0 0 0 0
 Innenzehner: 2
 Weitester: 1105 (20.), 1045 (7.), 1014 (6.)
 beste Teiler: 147.8 (15.), 181.2 (8.), 246.3 (2.)
 Trefferkreis: 26.01 mm
 Trefferlage: 0.53 mm links, 2.30 mm hoch

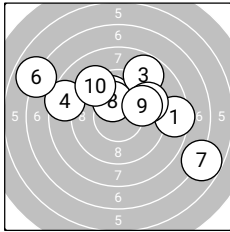
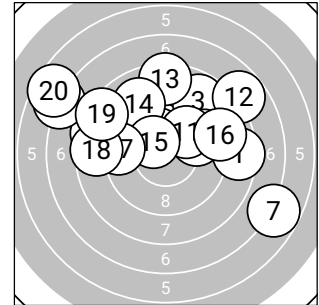

Serie 1: 88.1 (83)

8.4➔	10.0↖	8.8↗	8.5↖	9.5➔
6.9↖	6.8➔	10.2*↖	9.8➔	9.2↖

beste Teiler: 181.2 (8.), 246.3 (2.), 291.7 (9.)
 Trefferkreis: 25.10 mm
 Trefferlage: 0.52 mm rechts, 1.62 mm hoch

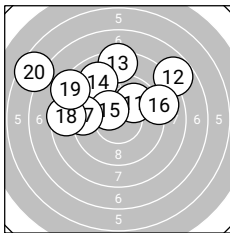

Serie 2: 87.3 (83)

9.9↗	7.8↗	8.4↑	9.0↖	10.4*↖
9.0➔	9.3↖	8.6↖	8.4↖	6.5↖

beste Teiler: 147.8 (15.), 258.2 (11.), 406.6 (17.)
 Trefferkreis: 20.40 mm
 Trefferlage: 1.58 mm links, 2.98 mm hoch



Ergebnis: **188.3** (177)
 Serien: 95.4 92.9
 Zähler: 4 9 7 0 0 0 0 0 0 0
 Innenzehner: 4
 Weitester: 667 (8.), 619 (12.), 610 (18.)
 beste Teiler: 126.5 (11.), 146.6 (4.), 186.0 (2.)
 Trefferkreis: 15.14 mm
 Trefferlage: 0.42 mm rechts, 2.51 mm hoch

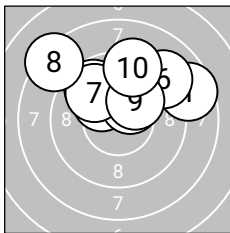
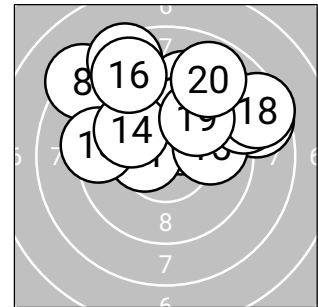

Serie 1: 95.4 (91)

8.6 ↗	10.2* ↖	9.7 ↖	10.4* ↗	9.8 ↗
9.1 ↗	9.8 ↖	8.3 ↖	10.2* ↗	9.3 ↗

beste Teiler: 146.6 (4.), 186.0 (2.), 197.6 (9.)
 Trefferkreis: 15.14 mm
 Trefferlage: 0.32 mm rechts, 2.48 mm hoch

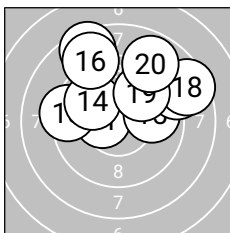

Serie 2: 92.9 (86)

10.4* ↖	8.5 ↖	9.3 ↖	9.9 ↖	9.9 →
8.8 ↖	8.9 ↗	8.5 ↗	9.8 ↗	8.9 ↗

beste Teiler: 126.5 (11.), 259.0 (14.), 272.6 (15.)
 Trefferkreis: 14.24 mm
 Trefferlage: 0.52 mm rechts, 2.53 mm hoch

Ergebnis: **182.5** (175)
 Serien: 89.9 92.6
 Zähler: 3 11 4 2 0 0 0 0 0 0 0
 Innenzehner: 2
 Weitester: 998 (1.), 823 (3.), 719 (17.)
 beste Teiler: 93.4 (2.), 156.9 (14.), 238.8 (5.)
 Trefferkreis: 18.93 mm
 Trefferlage: 2.68 mm links, 0.83 mm hoch

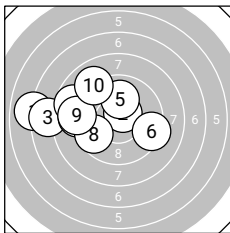
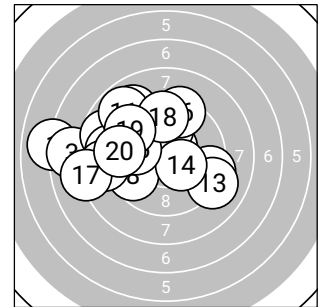

Serie 1: 89.9 (87)
 7.0 ← 10.6* ↗ 7.7 ← 8.7 ← 10.0 ↑
 9.3 → 9.0 ← 9.6 ← 9.0 ← 9.0 ↘
 beste Teiler: 93.4 (2.), 238.8 (5.), 332.0 (8.)
 Trefferkreis: 18.52 mm
 Trefferlage: 3.41 mm links, 0.79 mm hoch

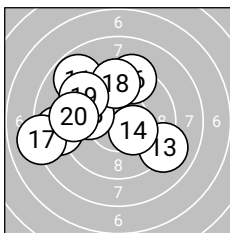

Serie 2: 92.6 (88)
 8.8 ↖ 8.8 ← 9.1 → 10.3* ↘ 9.9 ←
 9.3 ↗ 8.1 ← 9.6 ↑ 9.4 ↖ 9.3 ←
 beste Teiler: 156.9 (14.), 270.7 (15.), 345.9 (18.)
 Trefferkreis: 15.77 mm
 Trefferlage: 1.95 mm links, 0.87 mm hoch



Ergebnis: **172.1** (162)
 Serien: 84.7 87.4
 Zähler: 1 10 4 2 1 2 0 0 0 0 0
 Innenzehner: 1
 Weitester: 1438 (8.), 1372 (11.), 1008 (18.)
 beste Teiler: 164.3 (17.), 255.4 (7.), 262.1 (20.)
 Trefferkreis: 28.94 mm
 Trefferlage: 1.72 mm links, 0.08 mm tief

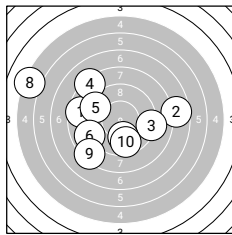
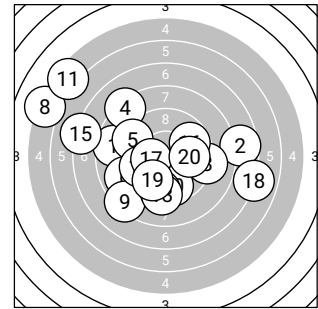

Serie 1: 84.7 (80)

8.6 ←	7.6 →	9.1 →	8.2 ↖	9.3 ↖
8.9 ↖	9.9 ↓	5.2 ↖	8.3 ↗	9.6 ↓

beste Teiler: 255.4 (7.), 336.4 (10.), 408.7 (5.)
 Trefferkreis: 26.46 mm
 Trefferlage: 2.22 mm links, 0.08 mm hoch

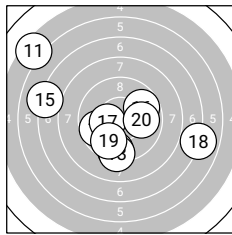

Serie 2: 87.4 (82)

5.5 ↖	9.4 ↓	9.2 ↓	9.7 ↖	7.1 ↖
9.7 ↗	10.3* ↖	6.9 →	9.7 ↗	9.9 →

beste Teiler: 164.3 (17.), 262.1 (20.), 302.1 (16.)
 Trefferkreis: 27.86 mm
 Trefferlage: 1.21 mm links, 0.25 mm tief



Ergebnis: **196.1** (188)
 Serien: 100.1 96.0
 Zähler: 11 6 3 0 0 0 0 0 0 0 0
 Innenzehner: 7
 Weitester: 684 (16.), 532 (15.), 527 (6.)
 beste Teiler: 58.5 (2.), 74.0 (18.), 109.1 (3.)
 Trefferkreis: 15.99 mm
 Trefferlage: 0.30 mm rechts, 0.60 mm hoch

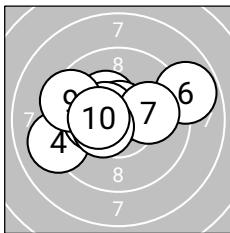
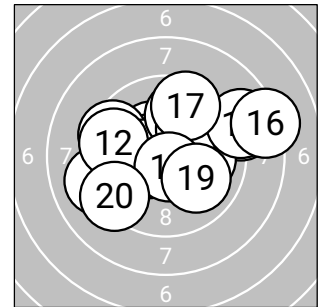

Serie 1: 100.1 (96)

10.3*↖	10.7*↑	10.5*↖	9.1↖	10.2*↖
8.8↗	10.1↗	10.5*↖	9.5↖	10.4*↖

beste Teiler: 58.5 (2.), 109.1 (3.), 121.7 (8.)
 Trefferkreis: 14.42 mm
 Trefferlage: 0.68 mm links, 0.42 mm hoch

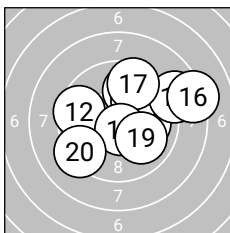

Serie 2: 96.0 (92)

9.8↗	9.6↖	10.0↗	10.0→	8.8↗
8.2↗	9.6↗	10.7*↘	10.0↘	9.3↖

beste Teiler: 74.0 (18.), 232.6 (14.), 240.0 (13.)
 Trefferkreis: 15.44 mm
 Trefferlage: 1.29 mm rechts, 0.78 mm hoch



Ergebnis: **186.8** (178)
 Serien: 88.7 98.1
 Zähler: 8 7 1 3 1 0 0 0 0 0 0
 Innenzehner: 7
 Weitestе: 1221 (2.), 954 (4.), 885 (6.)
 beste Teiler: 57.0 (15.), 83.0 (18.), 94.6 (19.)
 Trefferkreis: 19.93 mm
 Trefferlage: 2.33 mm rechts, 0.19 mm tief

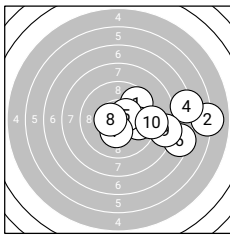
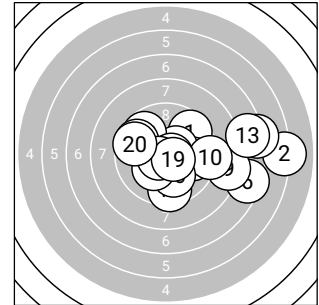

Serie 1: 88.7 (85)

9.6↗	6.1→	9.8→	7.1→	10.5*↗
7.4↘	10.3*↓	10.5*←	8.3→	9.1→

beste Teiler: 109.0 (8.), 122.6 (5.), 160.4 (7.)
 Trefferkreis: 17.80 mm
 Trefferlage: 4.59 mm rechts, 0.19 mm tief

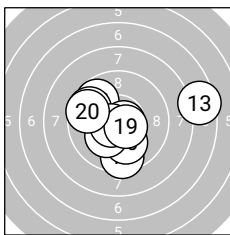

Serie 2: 98.1 (93)

9.5↓	9.7↖	7.5→	9.7↖	10.7*↗
10.0↓	10.2*↙	10.6*←	10.6*↘	9.6↖

beste Teiler: 57.0 (15.), 83.0 (18.), 94.6 (19.)
 Trefferkreis: 16.14 mm
 Trefferlage: 0.06 mm rechts, 0.20 mm tief



Ergebnis: **200.9** (190)
 Serien: 98.3 102.6
 Zähler: 13 5 1 1 0 0 0 0 0 0 0
 Innenzehner: 12
 Weitester: 780 (4.), 524 (7.), 328 (1.)
 beste Teiler: 42.5 (19.), 74.6 (8.), 96.4 (10.)
 Trefferkreis: 14.19 mm
 Trefferlage: 1.03 mm rechts, 1.12 mm tief

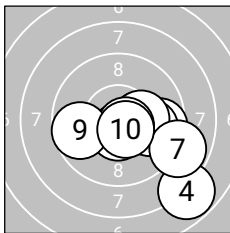
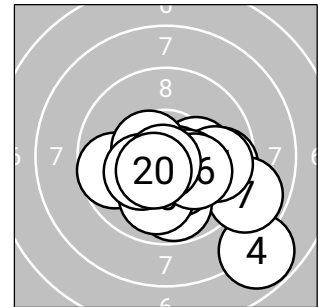

Serie 1: 98.3 (92)

9.6➔	10.6*↓	10.3*➔	7.8↘	9.9➔
10.2*➔	8.9↘	10.7*↘	9.7↙	10.6*↘

beste Teiler: 74.6 (8.), 96.4 (10.), 99.0 (2.)
 Trefferkreis: 14.19 mm
 Trefferlage: 1.74 mm rechts, 1.21 mm tief

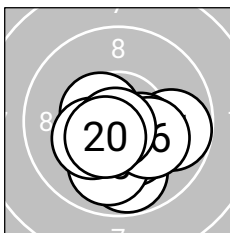

Serie 2: 102.6 (98)

9.8➔	10.4*↘	9.8↓	10.3*↘	10.0↓
10.2*↘	10.5*↙	10.3*↙	10.8*↘	10.5*↙

beste Teiler: 42.5 (19.), 108.7 (17.), 112.9 (20.)
 Trefferkreis: 8.89 mm
 Trefferlage: 0.32 mm rechts, 1.03 mm tief



Ergebnis: **202.5** (196)
 Serien: 100.8 101.7
 Zähler: 16 4 0 0 0 0 0 0 0 0 0
 Innenzehner: 11
 Weiteste: 398 (10.), 389 (1.), 360 (20.)
 beste Teiler: 98.1 (19.), 115.4 (12.), 123.0 (17.)
 Trefferkreis: 11.79 mm
 Trefferlage: 0.63 mm links, 0.06 mm hoch

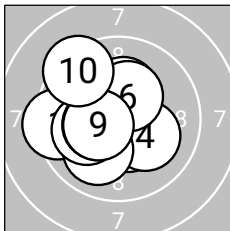
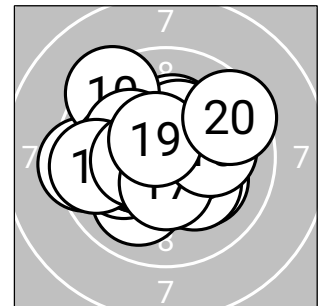

Serie 1: 100.8 (98)

9.4←	10.4*↘	10.3*↑	10.1↘	10.0↙
10.3*↗	10.1←	10.4*←	10.4*←	9.4↘

beste Teiler: 130.7 (2.), 133.1 (9.), 138.3 (8.)
 Trefferkreis: 10.61 mm
 Trefferlage: 0.90 mm links, 0.02 mm hoch

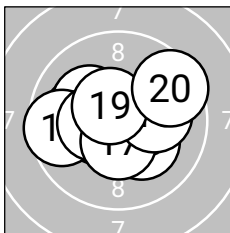

Serie 2: 101.7 (98)

10.1←	10.5*←	10.2*↖	9.6←	10.2*↘
10.4*←	10.5*↓	10.1→	10.6*↖	9.5↗

beste Teiler: 98.1 (19.), 115.4 (12.), 123.0 (17.)
 Trefferkreis: 11.30 mm
 Trefferlage: 0.35 mm links, 0.10 mm hoch

Ergebnis: **198.2** (189)
 Serien: 96.8 101.4
 Zähler: 10 9 1 0 0 0 0 0 0 0 0
 Innenzehner: 7
 Weitester: 527 (20.), 493 (2.), 481 (9.)
 beste Teiler: 55.9 (6.), 61.2 (19.), 108.6 (16.)
 Trefferkreis: 11.23 mm
 Trefferlage: 1.93 mm rechts, 0.92 mm hoch

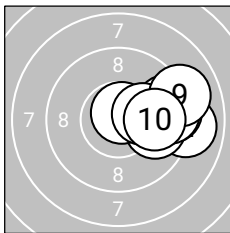
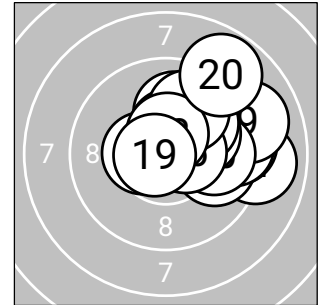

Serie 1: 96.8 (92)

9.7➔

9.0➔

9.4➔

9.5➔

9.9➔

10.7*↗

9.5➔

10.2*➔

9.0➔

9.9➔

beste Teiler: 55.9 (6.), 182.8 (8.), 265.0 (10.)

Trefferkreis: 9.29 mm

Trefferlage: 3.09 mm rechts, 0.41 mm hoch

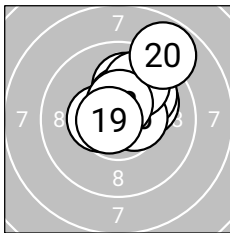

Serie 2: 101.4 (97)

10.5*←

10.1↗

10.0↑

10.0↗

10.4*↑

10.5*➔

9.9↗

10.5*↑

10.7*←

8.8↗

beste Teiler: 61.2 (19.), 108.6 (16.), 110.3 (18.)

Trefferkreis: 10.53 mm

Trefferlage: 0.78 mm rechts, 1.42 mm hoch



Ergebnis: **188.0** (178)
 Serien: 90.8 97.2
 Zähler: 4 11 4 1 0 0 0 0 0 0 0
 Innenzehner: 2
 Weitester: 789 (2.), 619 (4.), 558 (11.)
 beste Teiler: 124.5 (14.), 144.6 (16.), 222.4 (18.)
 Trefferkreis: 18.28 mm
 Trefferlage: 1.61 mm links, 1.39 mm hoch

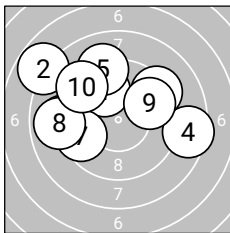
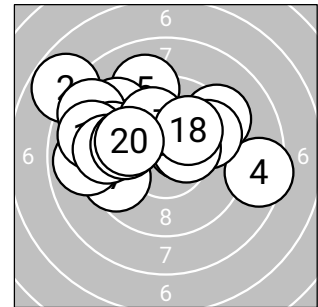

Serie 1: 90.8 (86)

9.8 ↗ 7.8 ↖ 9.0 ← 8.5 → 9.1 ↗
 9.3 ↗ 9.5 ↖ 8.9 ← 9.7 → 9.2 ↖

beste Teiler: 278.2 (1.), 307.7 (9.), 352.1 (7.)
 Trefferkreis: 18.28 mm
 Trefferlage: 1.32 mm links, 1.51 mm hoch

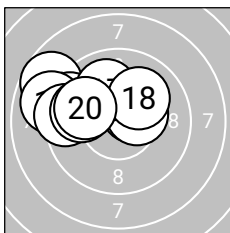

Serie 2: 97.2 (92)

8.7 ↖ 9.5 ↖ 8.9 ↖ 10.5* ↗ 9.4 ↖
 10.4* ↗ 10.0 ↗ 10.1 ↗ 9.8 ↖ 9.9 ↖

beste Teiler: 124.5 (14.), 144.6 (16.), 222.4 (18.)
 Trefferkreis: 11.09 mm
 Trefferlage: 1.90 mm links, 1.27 mm hoch



Ergebnis: **196.5** (187)
 Serien: 98.7 97.8
 Zähler: 9 9 2 0 0 0 0 0 0 0
 Innenzehner: 8
 Weitester: 673 (20.), 600 (19.), 470 (17.)
 beste Teiler: 9.4 (18.), 79.0 (3.), 109.6 (14.)
 Trefferkreis: 15.05 mm
 Trefferlage: 0.97 mm links, 0.54 mm hoch

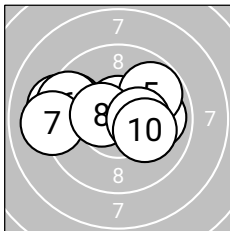
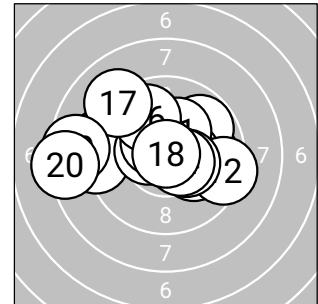

Serie 1: 98.7 (94)
 9.6 ← 9.2 ← 10.6* ↑ 9.9 → 9.8 ↗
 9.5 ← 9.1 ← 10.5* ← 10.4* → 10.1 ↘
 beste Teiler: 79.0 (3.), 120.5 (8.), 141.0 (9.)
 Trefferkreis: 11.76 mm
 Trefferlage: 0.87 mm links, 0.47 mm hoch

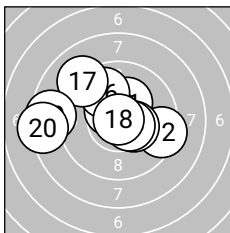

Serie 2: 97.8 (93)
 10.2* ↗ 9.4 → 10.4* → 10.5* → 10.5* ↖
 9.9 ↖ 9.1 ↖ 10.9* ↑ 8.6 ← 8.3 ←
 beste Teiler: 9.4 (18.), 109.6 (14.), 116.2 (15.)
 Trefferkreis: 15.05 mm
 Trefferlage: 1.08 mm links, 0.62 mm hoch

Ergebnis: **202.6** (193)
 Serien: 102.1 100.5
 Zähler: 14 5 1 0 0 0 0 0 0 0 0
 Innenzehner: 12
 Weitester: 530 (2.), 459 (17.), 449 (12.)
 beste Teiler: 53.6 (10.), 53.7 (16.), 64.3 (6.)
 Trefferkreis: 12.69 mm
 Trefferlage: 0.60 mm links, 0.39 mm hoch

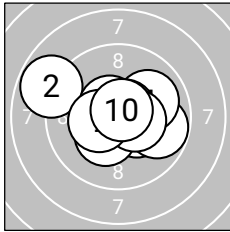
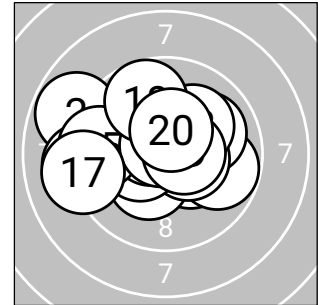

Serie 1: 102.1 (97)

10.3*↘	8.8↙	9.8↗	10.0↗	10.3*↘
10.7*↗	10.6*↙	10.5*↗	10.4*↙	10.7*↗

beste Teiler: 53.6 (10.), 64.3 (6.), 95.7 (7.)
 Trefferkreis: 12.69 mm
 Trefferlage: 0.04 mm rechts, 0.16 mm hoch

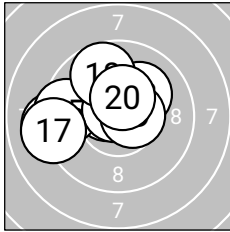

Serie 2: 100.5 (96)

10.6*↙	9.2↙	10.1↗	10.6*↙	9.5↙
10.7*↙	9.1↙	9.7↙	10.6*↗	10.4*↗

beste Teiler: 53.7 (16.), 87.6 (11.), 96.5 (14.)
 Trefferkreis: 10.96 mm
 Trefferlage: 1.24 mm links, 0.62 mm hoch



Ergebnis: **186.8** (177)
 Serien: 97.4 89.4
 Zähler: 8 6 4 0 1 1 0 0 0 0 0
 Innenezehner: 7
 Weitestе: 1285 (20.), 1036 (15.), 623 (7.)
 beste Teiler: 24.3 (9.), 143.3 (1.), 143.3 (16.)
 Trefferkreis: 27.61 mm
 Trefferlage: 0.48 mm links, 0.22 mm hoch

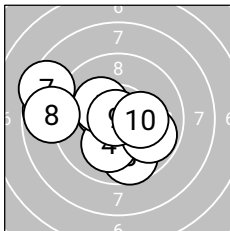
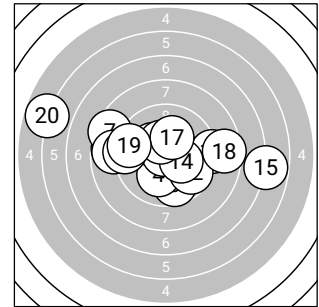

Serie 1: 97.4 (92)

10.4*↖	8.8←	9.7↓	10.1↓	10.2*↖
9.8↗	8.5←	8.8←	10.9*↖	10.2*↗

beste Teiler: 24.3 (9.), 143.3 (1.), 177.2 (5.)
 Trefferkreis: 13.50 mm
 Trefferlage: 1.49 mm links, 0.10 mm tief

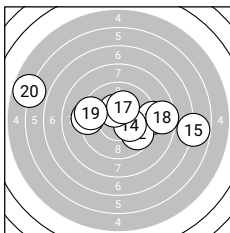

Serie 2: 89.4 (85)

9.0→	9.7↘	9.3←	10.3*↘	6.8→
10.4*↖	10.2*↗	8.5→	9.4←	5.8←

beste Teiler: 143.3 (16.), 169.3 (14.), 191.9 (17.)
 Trefferkreis: 27.61 mm
 Trefferlage: 0.51 mm rechts, 0.56 mm hoch



Ergebnis: **205.3** (195)
 Serien: 101.5 103.8
 Zähler: 15 5 0 0 0 0 0 0 0 0 0
 Innenzehner: 14
 Weitester: 485 (6.), 363 (9.), 309 (1.)
 beste Teiler: 9.8 (12.), 58.5 (4.), 61.5 (2.)
 Trefferkreis: 12.99 mm
 Trefferlage: 0.03 mm links, 0.45 mm tief

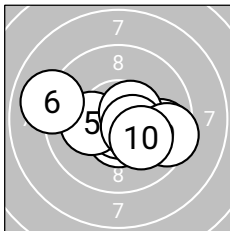
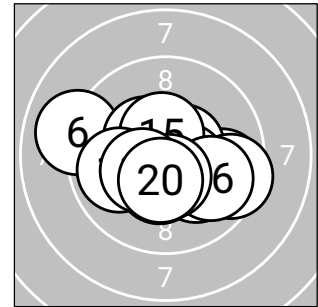

Serie 1: 101.5 (97)

9.7➔	10.7*↓	10.5*↓	10.7*↓	10.2*←
9.0←	10.6*➔	10.5*➔	9.5➔	10.1➔

beste Teiler: 58.5 (4.), 61.5 (2.), 98.4 (7.)
 Trefferkreis: 12.99 mm
 Trefferlage: 0.35 mm rechts, 0.48 mm tief

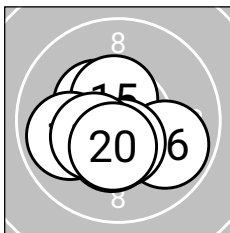

Serie 2: 103.8 (98)

10.5*←	10.9*↗	10.4*↖	10.4*↓	10.5*↑
9.9➔	10.5*↓	9.9←	10.4*↖	10.4*↓

beste Teiler: 9.8 (12.), 110.6 (11.), 111.1 (15.)
 Trefferkreis: 9.41 mm
 Trefferlage: 0.41 mm links, 0.42 mm tief

Ergebnis: **202.0** (193)
 Serien: 103.0 99.0
 Zähler: 15 3 2 0 0 0 0 0 0 0 0
 Innenzehner: 13
 Weitester: 587 (16.), 522 (15.), 450 (20.)
 beste Teiler: 44.7 (6.), 50.6 (18.), 57.2 (10.)
 Trefferkreis: 15.41 mm
 Trefferlage: 0.40 mm links, 0.12 mm tief

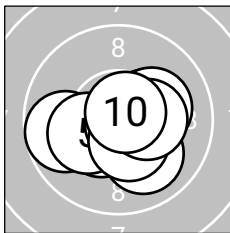
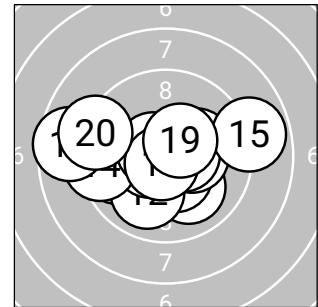

Serie 1: 103.0 (99)

10.0 ↘	10.3* →	10.4* ↙	9.7 ←	10.2* ↙
10.8* ↘	10.2* →	10.4* ↘	10.3* →	10.7* ↗

beste Teiler: 44.7 (6.), 57.2 (10.), 130.1 (8.)
 Trefferkreis: 9.49 mm
 Trefferlage: 0.21 mm rechts, 0.39 mm tief

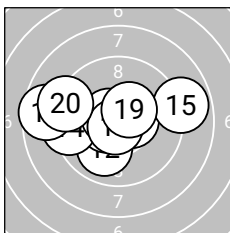

Serie 2: 99.0 (94)

10.5* →	10.0 ↙	10.6* ←	9.4 ←	8.9 →
8.6 ←	10.6* ←	10.8* ↙	10.4* ↗	9.2 ←

beste Teiler: 50.6 (18.), 87.2 (17.), 99.3 (13.)
 Trefferkreis: 15.41 mm
 Trefferlage: 1.02 mm links, 0.15 mm hoch



Ergebnis: **195.8** (190)
 Serien: 97.7 98.1
 Zähler: 12 6 2 0 0 0 0 0 0 0
 Innenzehner: 8
 Weitest: 713 (5.), 522 (10.), 498 (18.)
 beste Teiler: 60.9 (16.), 125.3 (4.), 136.2 (15.)
 Trefferkreis: 13.28 mm
 Trefferlage: 1.54 mm links, 0.72 mm hoch

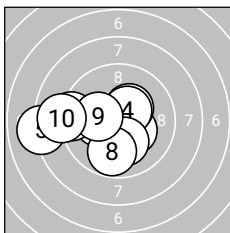
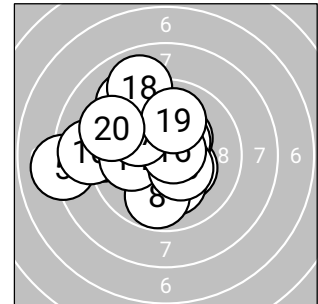

Serie 1: 97.7 (94)

10.3*↘	10.2*←	10.3*↗	10.5*↗	8.1←
9.2←	10.2*↓	9.8↓	10.2*←	8.9←

beste Teiler: 125.3 (4.), 153.2 (3.), 158.6 (1.)
 Trefferkreis: 12.94 mm
 Trefferlage: 1.71 mm links, 0.33 mm tief

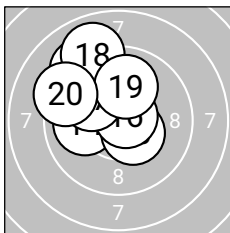

Serie 2: 98.1 (96)

10.1↗	9.4↖	9.2↖	10.0←	10.4*↘
10.7*↗	10.0↖	9.0↖	10.0↗	9.3↖

beste Teiler: 60.9 (16.), 136.2 (15.), 205.0 (11.)
 Trefferkreis: 10.74 mm
 Trefferlage: 1.38 mm links, 1.77 mm hoch

Ergebnis: **189.1** (181)
 Serien: 98.5 90.6
 Zähler: 6 9 5 0 0 0 0 0 0 0 0
 Innenzehner: 4
 Weitester: 687 (12.), 652 (20.), 613 (18.)
 beste Teiler: 135.1 (2.), 135.9 (6.), 153.0 (3.)
 Trefferkreis: 16.80 mm
 Trefferlage: 1.13 mm rechts, 0.08 mm hoch

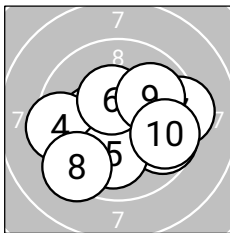
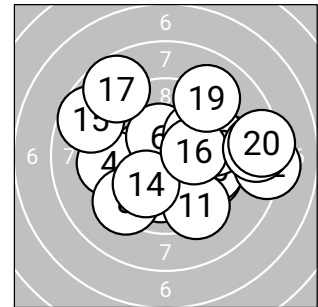

Serie 1: 98.5 (94)

9.7↘	10.4*↓	10.3*←	9.4←	10.1↓
10.4*↖	9.3→	9.3↙	9.9↗	9.7→

beste Teiler: 135.1 (2.), 135.9 (6.), 153.0 (3.)
 Trefferkreis: 12.38 mm
 Trefferlage: 0.29 mm rechts, 0.59 mm tief

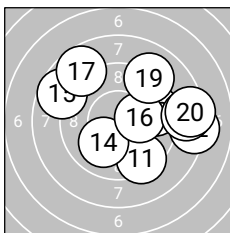

Serie 2: 90.6 (87)

9.4↘	8.2→	9.6→	10.0↙	8.7←
10.2*→	8.7↖	8.5→	9.0↗	8.3→

beste Teiler: 194.0 (16.), 230.2 (14.), 344.7 (13.)
 Trefferkreis: 16.80 mm
 Trefferlage: 1.97 mm rechts, 0.76 mm hoch



Ergebnis: **201.4** (192)
 Serien: 100.5 100.9
 Zähler: 12 8 0 0 0 0 0 0 0 0 0
 Innenzehner: 9
 Weitestе: 439 (8.), 399 (1.), 385 (12.)
 beste Teiler: 42.6 (13.), 77.4 (4.), 81.0 (10.)
 Trefferkreis: 12.21 mm
 Trefferlage: 0.84 mm links, 0.42 mm tief

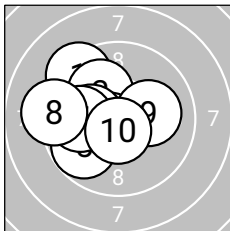
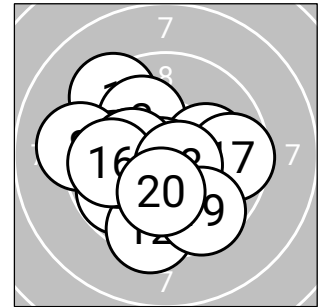

Serie 1: 100.5 (96)

9.4↖	10.6*←	10.1↖	10.6*↖	9.8↖
10.2*←	9.9←	9.2←	10.1→	10.6*↓

beste Teiler: 77.4 (4.), 81.0 (10.), 91.4 (2.)
 Trefferkreis: 10.92 mm
 Trefferlage: 1.45 mm links, 0.25 mm hoch

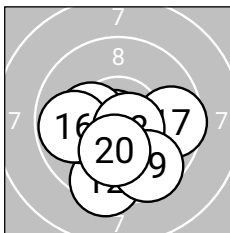

Serie 2: 100.9 (96)

10.6*↓	9.4↓	10.8*↗	10.0←	10.3*←
9.8←	9.6→	10.6*↘	9.6↘	10.2*↓

beste Teiler: 42.6 (13.), 82.6 (18.), 90.5 (11.)
 Trefferkreis: 10.72 mm
 Trefferlage: 0.22 mm links, 1.10 mm tief



Ergebnis: **199.5 (190)**
 Serien: 99.9 99.6
 Zähler: 10 10 0 0 0 0 0 0 0 0 0
 Innenzehner: 10
 Weitestе: 491 (10.), 433 (15.), 418 (11.)
 beste Teiler: 30.0 (14.), 64.6 (8.), 82.0 (4.)
 Trefferkreis: 13.57 mm
 Trefferlage: 0.00 mm , 0.45 mm hoch

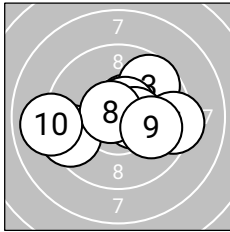
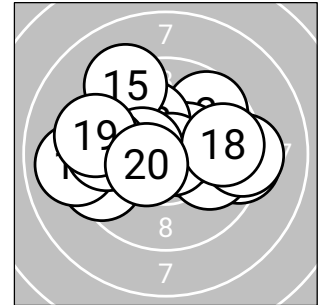

Serie 1: 99.9 (95)

10.5*↗	10.2*↗	9.7↗	10.6*↗	9.3→
10.5*→	9.5↙	10.7*↖	9.9→	9.0←

beste Teiler: 64.6 (8.), 82.0 (4.), 101.8 (1.)
 Trefferkreis: 13.38 mm
 Trefferlage: 0.37 mm rechts, 0.17 mm hoch

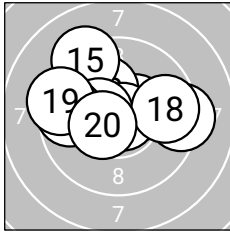

Serie 2: 99.6 (95)

9.3→	10.4*↗	10.2*↖	10.8*→	9.2↖
10.4*↖	9.7←	9.7→	9.4←	10.5*↖

beste Teiler: 30.0 (14.), 119.9 (20.), 126.5 (12.)
 Trefferkreis: 12.58 mm
 Trefferlage: 0.37 mm links, 0.74 mm hoch



Ergebnis: **199.1** (189)
 Serien: 99.1 100.0
 Zähler: 9 11 0 0 0 0 0 0 0 0
 Innenzehner: 5
 Weitester: 390 (15.), 363 (11.), 327 (6.)
 beste Teiler: 65.1 (1.), 67.1 (14.), 105.9 (12.)
 Trefferkreis: 11.46 mm
 Trefferlage: 0.88 mm rechts, 0.50 mm hoch

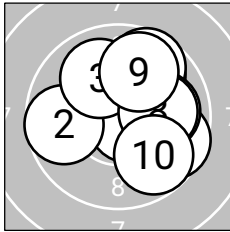
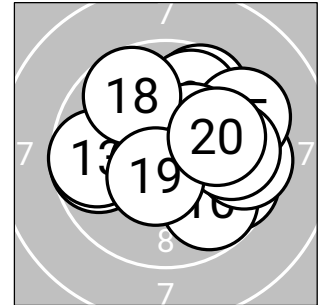

Serie 1: 99.1 (94)

10.7*↘	9.7←	10.0↖	9.8↗	9.7↗
9.6↘	10.0→	10.0→	9.8↗	9.8↘

beste Teiler: 65.1 (1.), 227.8 (8.), 242.4 (3.)
 Trefferkreis: 10.89 mm
 Trefferlage: 1.04 mm rechts, 0.61 mm hoch

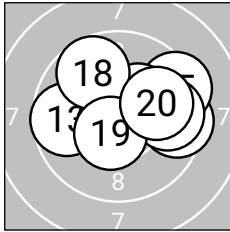

Serie 2: 100.0 (95)

9.5→	10.5*←	9.7←	10.7*↘	9.4↗
10.3*↗	9.7→	9.7↖	10.5*↘	10.0→

beste Teiler: 67.1 (14.), 105.9 (12.), 114.1 (19.)
 Trefferkreis: 11.46 mm
 Trefferlage: 0.72 mm rechts, 0.39 mm hoch



Ergebnis: **177.1 (168)**
 Serien: 82.9 94.2
 Zähler: 5 6 6 1 1 0 0 1 0 0 0
 Innenzehner: 3
 Weitester: 1777 (6.), 1027 (7.), 840 (5.)
 beste Teiler: 87.6 (16.), 134.0 (14.), 159.6 (20.)
 Trefferkreis: 32.43 mm
 Trefferlage: 2.70 mm rechts, 0.50 mm tief

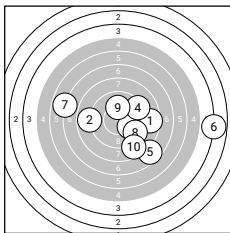
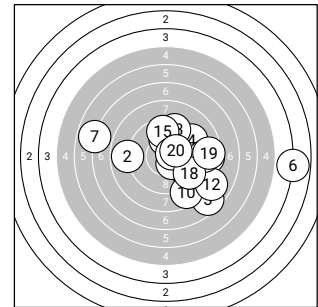

Serie 1: 82.9 (78)

8.6➔ 8.8← 10.0➤ 9.3↗ 7.6↘
 3.8➔ 6.8← 9.4➤ 10.0↑ 8.6↘

beste Teiler: 229.2 (9.), 239.9 (3.), 390.2 (8.)
 Trefferkreis: 32.43 mm
 Trefferlage: 2.58 mm rechts, 0.90 mm tief

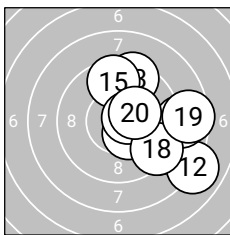

Serie 2: 94.2 (90)

9.3↘ 8.0↘ 9.4↑ 10.4*↘ 9.6↑
 10.6*➔ 8.8➔ 9.3↘ 8.5➔ 10.3*➔

beste Teiler: 87.6 (16.), 134.0 (14.), 159.6 (20.)
 Trefferkreis: 14.51 mm
 Trefferlage: 2.83 mm rechts, 0.11 mm tief



Ergebnis: **202.5** (195)
 Serien: 101.2 101.3
 Zähler: 15 5 0 0 0 0 0 0 0 0 0
 Innezzehner: 12
 Weitest: 500 (2.), 400 (20.), 386 (1.)
 beste Teiler: 57.2 (6.), 71.1 (7.), 95.0 (4.)
 Trefferkreis: 12.53 mm
 Trefferlage: 0.38 mm links, 0.28 mm hoch

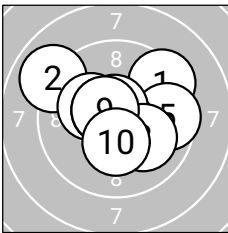
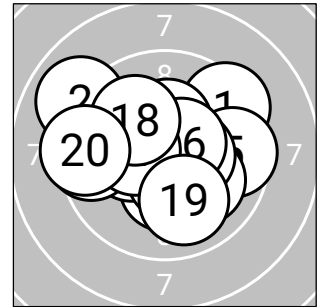

Serie 1: 101.2 (97)

9.4 ↗	9.0 ↖	10.2* ↖	10.6* ↖	9.6 →
10.7* ↘	10.7* ↗	10.1 ↘	10.6* ↖	10.3* ↓

beste Teiler: 57.2 (6.), 71.1 (7.), 95.0 (4.)
 Trefferkreis: 12.53 mm
 Trefferlage: 0.10 mm rechts, 0.46 mm hoch

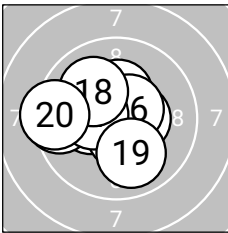

Serie 2: 101.3 (98)

10.3* ↑	10.4* →	10.3* ←	10.5* ↓	9.5 ←
10.5* ↗	10.4* ←	10.0 ↖	10.0 ↓	9.4 ←

beste Teiler: 103.0 (16.), 112.8 (14.), 128.0 (12.)
 Trefferkreis: 10.08 mm
 Trefferlage: 0.87 mm links, 0.10 mm hoch



Ergebnis: **154.8** (146)
 Serien: 68.3 86.5
 Zähler: 3 5 2 5 1 2 0 1 0 1 0
 Innenzehner: 2
 Weitester: 2439 (9.), 1990 (10.), 1383 (11.)
 beste Teiler: 62.6 (17.), 163.2 (3.), 226.1 (16.)
 Trefferkreis: 48.40 mm
 Trefferlage: 2.27 mm rechts, 1.46 mm tief

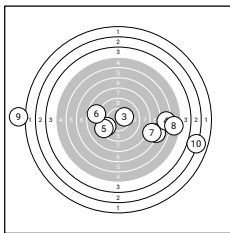
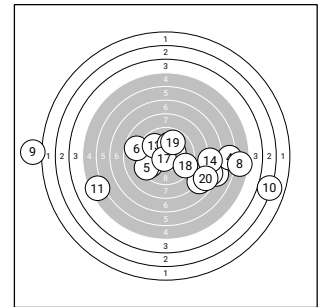

Serie 1: 68.3 (65)
 7.0➡ 9.6↙ 10.3*➡ 6.3➡ 9.3↙
 8.7↙ 7.4➡ 5.5➡ 1.2↙ 3.0➡
 beste Teiler: 163.2 (3.), 327.2 (2.), 412.2 (5.)
 Trefferkreis: 48.40 mm
 Trefferlage: 2.71 mm rechts, 1.50 mm tief

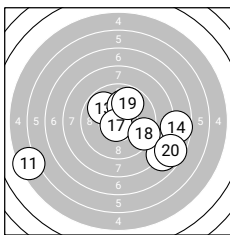

Serie 2: 86.5 (81)
 5.4↙ 8.2➡ 9.8↙ 7.7➡ 7.9➡
 10.0↗ 10.7*↙ 9.4➡ 9.8↗ 7.6➡
 beste Teiler: 62.6 (17.), 226.1 (16.), 278.2 (13.)
 Trefferkreis: 25.75 mm
 Trefferlage: 1.84 mm rechts, 1.43 mm tief



Ergebnis: **201.7** (194)
 Serien: 100.9 100.8
 Zähler: 15 4 1 0 0 0 0 0 0 0 0
 Innenzehner: 7
 Weitester: 520 (14.), 461 (4.), 371 (8.)
 beste Teiler: 6.4 (20.), 20.0 (17.), 74.2 (7.)
 Trefferkreis: 13.90 mm
 Trefferlage: 0.07 mm links, 0.22 mm hoch

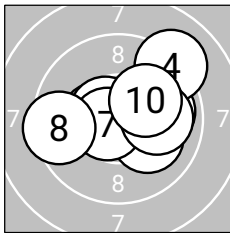
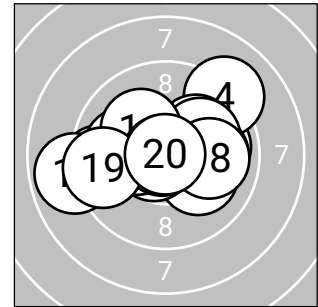

Serie 1: 100.9 (97)

9.9➔	10.5*➔	10.1➔	9.1↗	10.4*←
10.6*↖	10.7*↖	9.5←	10.0➔	10.1↗

beste Teiler: 74.2 (7.), 88.1 (6.), 116.6 (2.)
 Trefferkreis: 12.42 mm
 Trefferlage: 0.63 mm rechts, 0.30 mm hoch

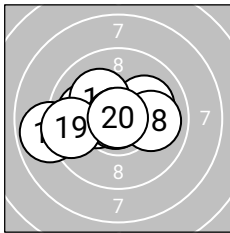

Serie 2: 100.8 (97)

10.1➔	10.1➔	10.3*←	8.9←	10.0←
10.1↖	10.9*←	10.0➔	9.5←	10.9*↖

beste Teiler: 6.4 (20.), 20.0 (17.), 162.0 (13.)
 Trefferkreis: 12.08 mm
 Trefferlage: 0.78 mm links, 0.15 mm hoch

Ergebnis: **191.7 (182)**
 Serien: 95.3 96.4
 Zähler: 6 10 4 0 0 0 0 0 0 0 0
 Innenzehner: 5
 Weitester: 660 (17.), 581 (14.), 540 (2.)
 beste Teiler: 78.6 (15.), 116.0 (8.), 135.0 (16.)
 Trefferkreis: 12.66 mm
 Trefferlage: 2.03 mm rechts, 2.10 mm tief

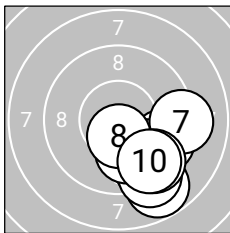
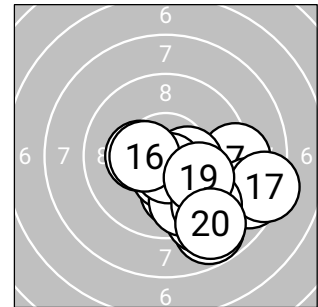

Serie 1: 95.3 (91)

9.4 ↘ 8.8 ↘ 9.6 ➡ 9.1 ↘ 10.0 ↘
 9.8 ↘ 9.2 ➡ 10.5* ↓ 9.4 ↘ 9.5 ↘

beste Teiler: 116.0 (8.), 233.1 (5.), 289.4 (6.)
 Trefferkreis: 9.81 mm
 Trefferlage: 2.16 mm rechts, 2.50 mm tief

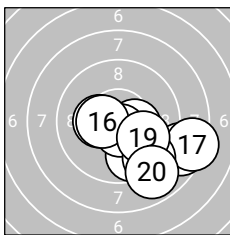

Serie 2: 96.4 (91)

9.7 ↘ 10.3* ← 10.4* ➡ 8.6 ➡ 10.6* ↓
 10.4* ← 8.3 ➡ 9.3 ↘ 9.9 ➡ 8.9 ↘

beste Teiler: 78.6 (15.), 135.0 (16.), 143.5 (13.)
 Trefferkreis: 12.66 mm
 Trefferlage: 1.89 mm rechts, 1.71 mm tief



Ergebnis: **183.0** (177)
 Serien: 91.2 91.8
 Zähler: 7 8 2 2 0 1 0 0 0 0 0
 Innenzehner: 5
 Weitester: 1443 (10.), 840 (19.), 792 (17.)
 beste Teiler: 59.1 (20.), 86.0 (7.), 100.6 (4.)
 Trefferkreis: 26.99 mm
 Trefferlage: 1.36 mm links, 0.58 mm tief

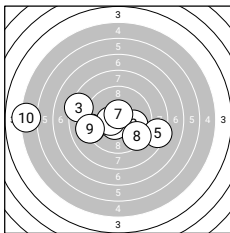
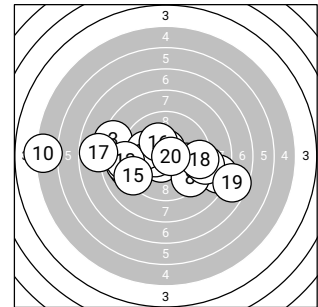

Serie 1: 91.2 (88)

9.1 ← 10.0 → 8.4 ← 10.6* ↙ 8.3 →
 10.5* ← 10.6* ↑ 9.4 → 9.1 ← 5.2 ←

beste Teiler: 86.0 (7.), 100.6 (4.), 123.4 (6.)
 Trefferkreis: 25.23 mm
 Trefferlage: 1.97 mm links, 0.60 mm tief

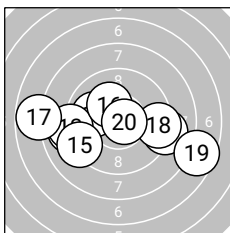

Serie 2: 91.8 (89)

9.0 ← 10.0 ← 9.0 ← 9.0 → 9.2 ↙
 10.2* ↖ 7.8 ← 9.3 → 7.6 → 10.7* →

beste Teiler: 59.1 (20.), 186.1 (16.), 249.0 (12.)
 Trefferkreis: 20.60 mm
 Trefferlage: 0.75 mm links, 0.57 mm tief



Ergebnis: **193.9** (186)
 Serien: 96.8 97.1
 Zähler: 8 10 2 0 0 0 0 0 0 0
 Innenzehner: 3
 Weitester: 728 (14.), 688 (12.), 487 (3.)
 beste Teiler: 72.0 (8.), 144.2 (11.), 147.3 (20.)
 Trefferkreis: 15.78 mm
 Trefferlage: 0.29 mm links, 1.24 mm tief

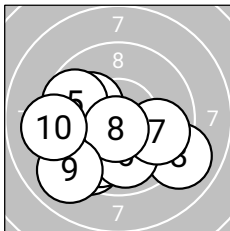
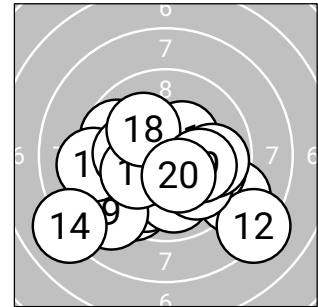

Serie 1: 96.8 (92)
 10.1 ↙ 9.5 ↙ 9.0 ➤ 9.9 ↙ 9.7 ↙
 9.9 ↓ 9.8 ➤ 10.7* ↓ 9.0 ↙ 9.2 ↙
 beste Teiler: 72.0 (8.), 212.4 (1.), 251.8 (6.)
 Trefferkreis: 13.30 mm
 Trefferlage: 0.87 mm links, 1.39 mm tief

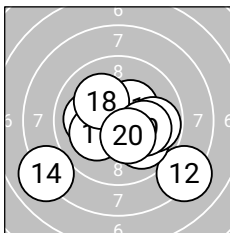

Serie 2: 97.1 (94)
 10.4* ↗ 8.2 ➤ 10.1 ← 8.0 ↙ 9.9 ➤
 9.8 ➤ 10.1 ↙ 10.1 ↙ 10.1 ➤ 10.4* ↘
 beste Teiler: 144.2 (11.), 147.3 (20.), 201.1 (17.)
 Trefferkreis: 15.75 mm
 Trefferlage: 0.27 mm rechts, 1.08 mm tief



Ergebnis: **191.2 (182)**
 Serien: 95.7 95.5
 Zähler: 8 6 6 0 0 0 0 0 0 0
 Innenzehner: 6
 Weitester: 732 (14.), 635 (8.), 629 (17.)
 beste Teiler: 65.1 (16.), 67.9 (19.), 102.4 (7.)
 Trefferkreis: 16.71 mm
 Trefferlage: 1.10 mm links, 0.87 mm tief

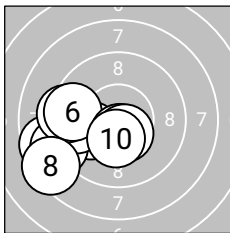
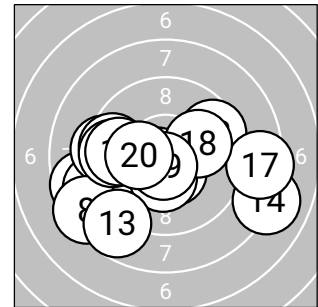

Serie 1: 95.7 (91)

10.0←	8.6←	8.9←	9.6←	9.3←
9.5←	10.5*↓	8.4←	10.5*↓	10.4*↓

beste Teiler: 102.4 (7.), 115.4 (9.), 147.1 (10.)
 Trefferkreis: 10.77 mm
 Trefferlage: 2.79 mm links, 1.12 mm tief

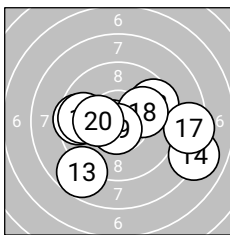

Serie 2: 95.5 (91)

9.5←	9.6→	8.7↙	8.0→	9.7←
10.7*↙	8.4→	10.0→	10.7*↓	10.2*←

beste Teiler: 65.1 (16.), 67.9 (19.), 178.0 (20.)
 Trefferkreis: 15.25 mm
 Trefferlage: 0.58 mm rechts, 0.62 mm tief



Ergebnis: **200.0** (190)
 Serien: 97.7 102.3
 Zähler: 12 6 2 0 0 0 0 0 0 0
 Innenzehner: 9
 Weitestе: 633 (6.), 621 (7.), 422 (4.)
 beste Teiler: 44.3 (19.), 61.8 (11.), 63.0 (15.)
 Trefferkreis: 16.68 mm
 Trefferlage: 0.97 mm links, 0.63 mm tief

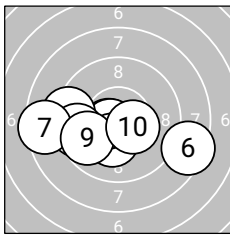
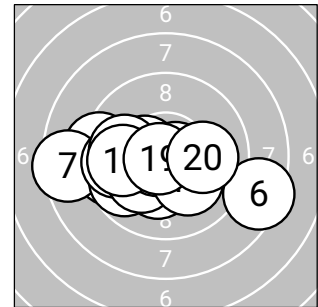

Serie 1: 97.7 (93)

10.6*←	10.5*↓	10.6*←	9.3←	9.5←
8.4→	8.5←	10.2*↓	9.7←	10.4*→

beste Teiler: 84.4 (3.), 96.7 (1.), 103.1 (2.)
 Trefferkreis: 16.68 mm
 Trefferlage: 1.16 mm links, 0.92 mm tief

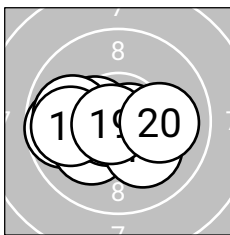

Serie 2: 102.3 (97)

10.7*→	10.4*←	9.7←	10.1←	10.7*←
10.1→	9.9←	9.9←	10.8*←	10.0→

beste Teiler: 44.3 (19.), 61.8 (11.), 63.0 (15.)
 Trefferkreis: 9.92 mm
 Trefferlage: 0.78 mm links, 0.34 mm tief



Ergebnis: **193.2** (184)
 Serien: 94.7 98.5
 Zähler: 9 7 3 1 0 0 0 0 0 0
 Innenzehner: 7
 Weitester: 772 (10.), 678 (4.), 635 (5.)
 beste Teiler: 46.9 (6.), 81.0 (19.), 105.4 (9.)
 Trefferkreis: 19.01 mm
 Trefferlage: 1.02 mm links, 0.46 mm tief

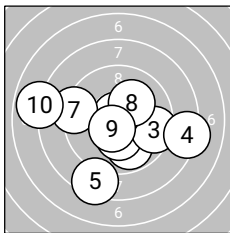
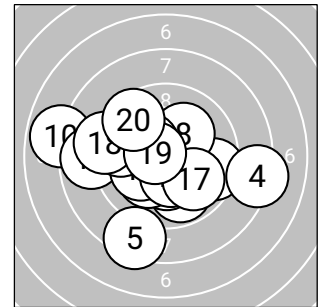

Serie 1: 94.7 (90)

9.8 ↘	10.3* ↓	9.5 →	8.2 →	8.4 ↓
10.8* ↖	9.2 ←	10.1 ↗	10.5* ↘	7.9 ←

beste Teiler: 46.9 (6.), 105.4 (9.), 167.1 (2.)
 Trefferkreis: 19.01 mm
 Trefferlage: 0.24 mm links, 0.90 mm tief

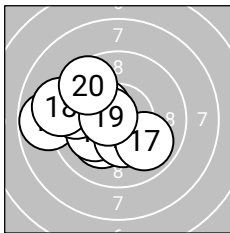

Serie 2: 98.5 (94)

10.2* ↗	10.3* ↖	8.8 ←	10.1 ←	9.6 ←
10.4* ↓	9.9 ↘	9.1 ←	10.6* ←	9.5 ↖

beste Teiler: 81.0 (19.), 148.6 (16.), 156.7 (12.)
 Trefferkreis: 12.05 mm
 Trefferlage: 1.81 mm links, 0.03 mm tief

Ergebnis: **205.4** (196)
 Serien: 102.8 102.6
 Zähler: 16 4 0 0 0 0 0 0 0 0
 Innenzehner: 14
 Weitester: 292 (18.), 279 (14.), 264 (3.)
 beste Teiler: 14.1 (15.), 43.0 (17.), 106.2 (9.)
 Trefferkreis: 9.79 mm
 Trefferlage: 0.25 mm rechts, 0.67 mm tief

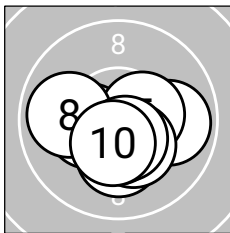
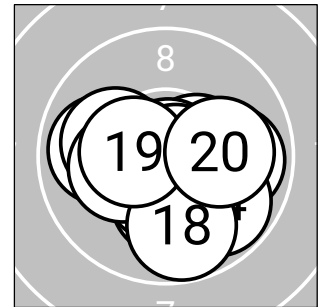

Serie 1: 102.8 (98)

10.2*↓	10.4*↘	9.9→	10.3*←	10.4*→
10.3*↘	10.5*↓	9.9←	10.5*↓	10.4*↓

beste Teiler: 106.2 (9.), 118.2 (7.), 127.3 (10.)
 Trefferkreis: 9.75 mm
 Trefferlage: 0.18 mm rechts, 0.71 mm tief

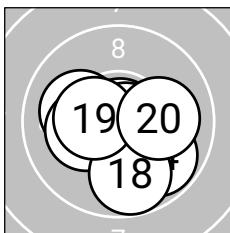

Serie 2: 102.6 (98)

10.3*↘	10.2*↘	10.1←	9.8↘	10.9*↗
10.2*←	10.8*↘	9.8↓	10.4*←	10.1→

beste Teiler: 14.1 (15.), 43.0 (17.), 132.0 (19.)
 Trefferkreis: 9.30 mm
 Trefferlage: 0.32 mm rechts, 0.63 mm tief



Ergebnis: **143.2** (133)
 Serien: 67.1 76.1
 Zähler: 1 3 4 4 2 1 4 1 0 0 0
 Innenzehner: 1
 Weitester: 1986 (6.), 1727 (17.), 1688 (9.)
 beste Teiler: 105.2 (7.), 337.0 (14.), 350.3 (2.)
 Trefferkreis: 41.60 mm
 Trefferlage: 0.74 mm links, 1.45 mm hoch

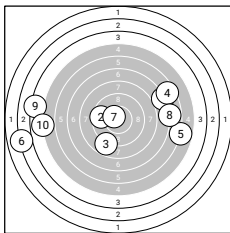
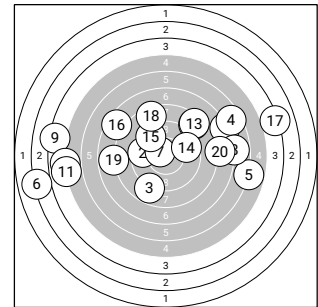

Serie 1: 67.1 (62)

7.0 → 9.6 ← 8.8 ↙ 6.5 → 5.8 →
 3.0 ← 10.5* ↖ 6.8 → 4.2 ← 4.9 ←

beste Teiler: 105.2 (7.), 350.3 (2.), 540.6 (3.)
 Trefferkreis: 36.43 mm
 Trefferlage: 1.64 mm links, 0.14 mm hoch

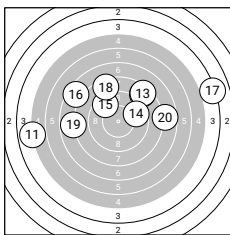

Serie 2: 76.1 (71)

4.9 ← 8.4 ↗ 8.3 ↗ 9.6 → 9.5 ↘
 7.5 ↖ 4.0 → 8.4 ↖ 7.8 ← 7.7 →

beste Teiler: 337.0 (14.), 368.4 (15.), 634.1 (12.)
 Trefferkreis: 36.82 mm
 Trefferlage: 0.15 mm rechts, 2.76 mm hoch

