

Ergebnis: 393.8 (375)
Serien: 95.0 99.4 98.8 100.6
Zähler: 18 19 3 0 0 0 0 0 0 0
Innenzehner: 14
Weiteste: 594 (6.), 591 (9.), 514 (23.)
beste Teiler: 49.0 (15.), 59.1 (40.), 70.8 (21.)
Trefferkreis: 16.23 mm
Trefferlage: 0.53 mm rechts, 0.04 mm hoch

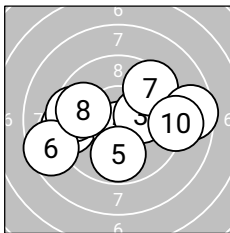
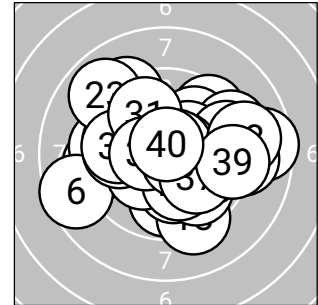

Serie 1: 95.0 (90)

9.3←	10.6*↓	10.2*→	9.5←	9.8↓
8.6←	9.5↗	9.8←	8.6→	9.1→

beste Teiler: 76.7 (2.), 189.0 (3.), 280.0 (5.)
Trefferkreis: 16.23 mm
Trefferlage: 0.09 mm links, 0.19 mm tief

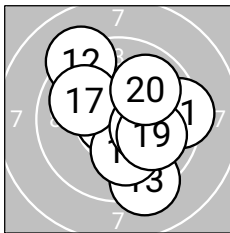

Serie 2: 99.4 (96)

9.4→	9.2↖	9.3↓	10.4*→	10.8*←
10.1↓	10.0←	10.3*→	10.0→	9.9↗

beste Teiler: 49.0 (15.), 129.1 (14.), 175.6 (18.)
Trefferkreis: 13.11 mm
Trefferlage: 0.78 mm rechts, 0.00 mm

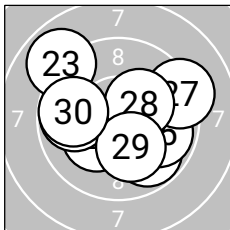

Serie 3: 98.8 (93)

10.7*↘	10.2*↖	8.9↖	9.8↘	9.9→
9.8←	9.2→	10.3*↗	10.2*↓	9.8←

beste Teiler: 70.8 (21.), 168.2 (28.), 180.4 (22.)
Trefferkreis: 12.75 mm
Trefferlage: 0.02 mm rechts, 0.03 mm hoch

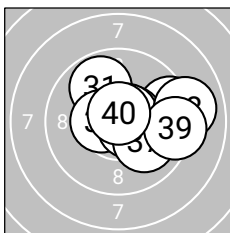

Serie 4: 100.6 (96)

9.9↖	10.5*←	9.4→	10.6*↘	10.6*→
10.6*↗	10.0↘	9.0→	9.3→	10.7*↑

beste Teiler: 59.1 (40.), 76.0 (36.), 84.9 (34.)
Trefferkreis: 10.80 mm
Trefferlage: 1.43 mm rechts, 0.35 mm hoch



LG 40 ZR

StandNr: 120

Schmutz, Lena #70819445

Jungschützinnen

Wertung

StartNr: 20

08.03.2026 09:27

SG_Tannheim

Ergebnis: **399.6 (381)**
 Serien: 100.4 99.2 98.6 101.4
 Zähler: 22 17 1 0 0 0 0 0 0 0
 Innenzehner: 21
 Weitester: 543 (21.), 496 (22.), 481 (32.)
 beste Teiler: 37.9 (12.), 59.0 (35.), 77.3 (38.)
 Trefferkreis: 13.92 mm
 Trefferlage: 0.53 mm links, 0.08 mm hoch

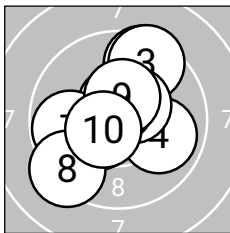
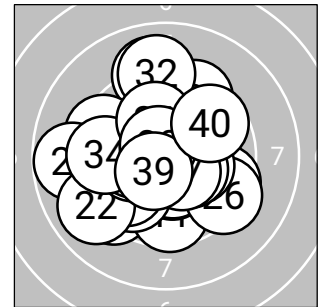

Serie 1: 100.4 (95)

10.4*↙ 9.5↗ 9.5↗ 9.9↘ 10.5*↗
 10.6*↗ 9.8↙ 9.3↙ 10.4*↗ 10.5*↙

beste Teiler: 89.2 (6.), 106.2 (10.), 123.7 (5.)
 Trefferkreis: 12.29 mm
 Trefferlage: 0.15 mm links, 0.41 mm hoch

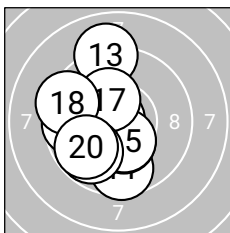

Serie 2: 99.2 (94)

9.6↓ 10.8*↙ 9.0↑ 10.4*↓ 10.4*↓
 9.7↙ 10.3*↗ 9.4↙ 9.8↙ 9.8↙

beste Teiler: 37.9 (12.), 143.2 (15.), 150.1 (14.)
 Trefferkreis: 12.60 mm
 Trefferlage: 1.18 mm links, 0.26 mm tief

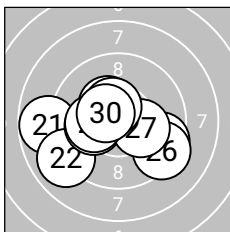

Serie 3: 98.6 (95)

8.8↙ 9.0↙ 10.2*↙ 9.5↘ 10.4*↗
 9.3↘ 10.2*↘ 10.5*↗ 10.2*↙ 10.5*↙

beste Teiler: 114.9 (30.), 118.8 (28.), 148.9 (25.)
 Trefferkreis: 13.50 mm
 Trefferlage: 0.71 mm links, 0.52 mm tief

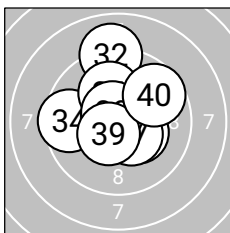

Serie 4: 101.4 (97)

10.6*↗ 9.0↑ 10.3*↘ 9.5↙ 10.7*↙
 10.1↑ 10.4*↘ 10.6*↗ 10.5*↙ 9.7↗

beste Teiler: 59.0 (35.), 77.3 (38.), 97.6 (31.)
 Trefferkreis: 10.98 mm
 Trefferlage: 0.07 mm links, 0.72 mm hoch



LG 40 ZR

StandNr: 121

Ullrich, Eva-Maria #70218043

Jungschützinnen

Wertung

StartNr: 21

08.03.2026 09:27

SG_Matrei_a._Br.

Ergebnis: 382.0 (363)
Serien: 93.4 95.2 94.4 99.0
Zähler: 13 21 2 4 0 0 0 0 0 0
Innenzehner: 10
Weiteste: 835 (20.), 805 (28.), 774 (30.)
beste Teiler: 34.0 (31.), 84.8 (32.), 94.4 (18.)
Trefferkreis: 20.91 mm
Trefferlage: 0.44 mm links, 0.79 mm hoch

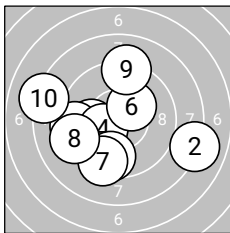
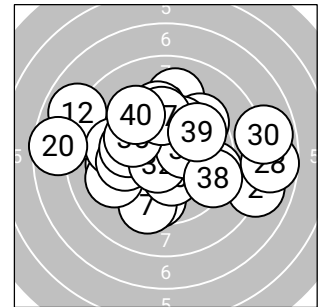

Serie 1: 93.4 (91)

10.0 ←	8.0 →	9.4 ←	10.3* ↖	9.6 ↓
10.3* ↗	9.4 ↓	9.2 ←	9.1 ↑	8.1 ←

beste Teiler: 158.6 (4.), 172.5 (6.), 246.1 (1.)
Trefferkreis: 18.87 mm
Trefferlage: 1.17 mm links, 0.52 mm tief

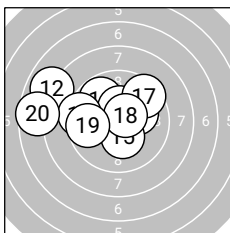

Serie 2: 95.2 (90)

9.8 ↖	7.9 ↖	10.1 →	10.4* ↑	10.3* ↓
9.3 ←	9.5 ↗	10.6* ↗	9.7 ←	7.6 ←

beste Teiler: 94.4 (18.), 141.5 (14.), 164.2 (15.)
Trefferkreis: 15.60 mm
Trefferlage: 1.82 mm links, 1.05 mm hoch

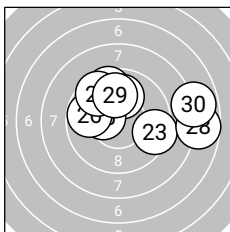

Serie 3: 94.4 (89)

10.2* ↖	9.6 ↑	9.4 →	10.0 ↑	10.3* ↖
9.8 ←	9.6 ↖	7.7 →	9.9 ↑	7.9 →

beste Teiler: 155.4 (25.), 177.0 (21.), 247.4 (24.)
Trefferkreis: 15.49 mm
Trefferlage: 1.03 mm rechts, 1.30 mm hoch

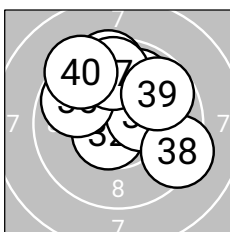

Serie 4: 99.0 (93)

10.8* ←	10.6* ↖	9.9 ↗	10.3* →	9.8 ↖
9.5 ↑	9.7 ↑	9.3 →	9.7 ↗	9.4 ↖

beste Teiler: 34.0 (31.), 84.8 (32.), 157.5 (34.)
Trefferkreis: 12.21 mm
Trefferlage: 0.19 mm rechts, 1.37 mm hoch



Ergebnis: 386.0 (367)
Serien: 97.9 94.8 95.7 97.6
Zähler: 13 21 6 0 0 0 0 0 0 0
Innenzehner: 9
Weiteste: 577 (26.), 573 (1.), 545 (39.)
beste Teiler: 99.7 (7.), 119.0 (32.), 128.9 (2.)
Trefferkreis: 15.50 mm
Trefferlage: 0.67 mm rechts, 0.99 mm hoch

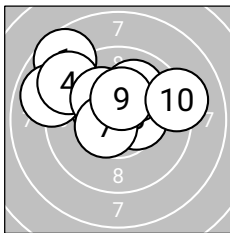
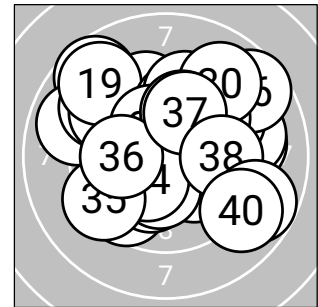

Serie 1: 97.9 (94)
 8.7↖ 10.4*↖ 8.9↖ 9.2↖ 10.4*↗
 10.2*↖ 10.6*↖ 10.0↗ 10.3*↑ 9.2↗
beste Teiler: 99.7 (7.), 128.9 (2.), 130.3 (5.)
Trefferkreis: 13.50 mm
Trefferlage: 0.85 mm links, 1.55 mm hoch

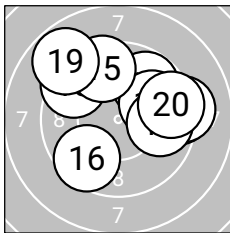

Serie 2: 94.8 (89)
 9.3↗ 9.8↗ 9.4↖ 9.9↗ 9.5↖
 9.6↖ 9.2↗ 9.8↗ 8.8↖ 9.5↗
beste Teiler: 252.7 (14.), 283.1 (18.), 297.0 (12.)
Trefferkreis: 13.35 mm
Trefferlage: 0.91 mm rechts, 1.24 mm hoch

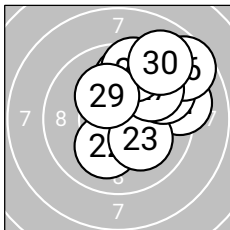

Serie 3: 95.7 (92)
 9.2↗ 10.1↖ 10.1↖ 9.5↗ 9.8↗
 8.6↗ 9.7↗ 9.5↗ 10.2*↖ 9.0↗
beste Teiler: 179.3 (29.), 205.5 (23.), 206.5 (22.)
Trefferkreis: 12.14 mm
Trefferlage: 1.88 mm rechts, 1.71 mm hoch

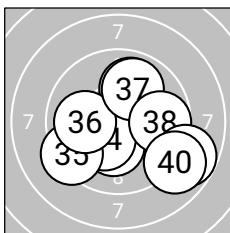

Serie 4: 97.6 (92)
 9.9↗ 10.5*↗ 10.3*↓ 10.3*↖ 9.3↖
 10.0↖ 9.9↗ 9.7↗ 8.8↖ 8.9↖
beste Teiler: 119.0 (32.), 162.6 (34.), 173.1 (33.)
Trefferkreis: 12.83 mm
Trefferlage: 0.77 mm rechts, 0.53 mm tief



LG 40 ZR

StandNr: 123

Stöckl, Mathea #70818374

Jungschützinnen

Wertung

StartNr: 23

08.03.2026 09:19

SG_Söller_Sportschützen

SG Söller Sportschützen 2

Ergebnis: **406.7** (387)
 Serien: 101.8 100.7 102.8 101.4
 Zähler: 27 13 0 0 0 0 0 0 0 0
 Innenzehner: 19
 Weitestе: 373 (40.), 362 (38.), 361 (16.)
 beste Teiler: 49.2 (28.), 67.9 (24.), 70.0 (33.)
 Trefferkreis: 11.49 mm
 Trefferlage: 0.37 mm rechts, 0.02 mm hoch

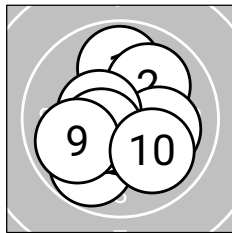
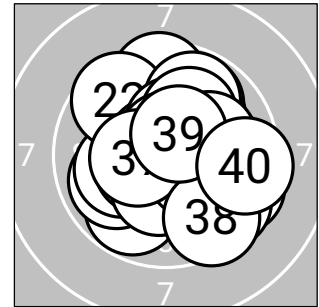
**Serie 1: 101.8** (97)

9.9↑	10.0↗	9.8↘	10.7*↓	10.4*↘
10.1➔	10.5*↙	10.5*↙	9.9↙	10.0➔

beste Teiler: 71.3 (4.), 118.0 (7.), 120.4 (8.)
 Trefferkreis: 9.90 mm
 Trefferlage: 0.01 mm rechts, 0.33 mm tief

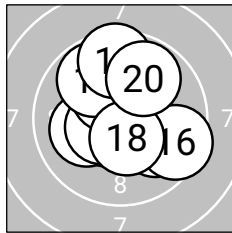
**Serie 2: 100.7** (96)

10.0➔	10.6*↙	10.1↙	10.5*↙	10.3*↙
9.5➔	9.8↘	10.5*↓	9.6↑	9.8↗

beste Teiler: 96.8 (12.), 120.3 (14.), 124.2 (18.)
 Trefferkreis: 10.81 mm
 Trefferlage: 0.08 mm rechts, 0.39 mm hoch

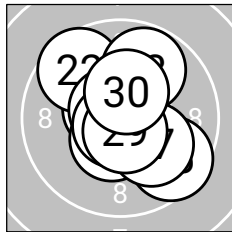
**Serie 3: 102.8** (97)

10.6*↙	9.6↘	9.8↗	10.7*↘	9.6➔
10.5*↓	10.1➔	10.8*↘	10.7*↓	10.4*↑

beste Teiler: 49.2 (28.), 67.9 (24.), 72.4 (29.)
 Trefferkreis: 11.26 mm
 Trefferlage: 0.19 mm rechts, 0.17 mm hoch

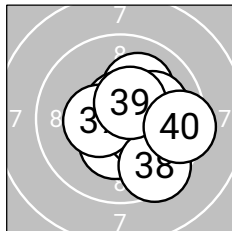
**Serie 4: 101.4** (97)

9.9➔	10.1↗	10.7*↑	10.3*↓	10.4*➔
10.1➔	10.4*↙	9.5↘	10.5*↗	9.5➔

beste Teiler: 70.0 (33.), 116.2 (39.), 131.6 (37.)
 Trefferkreis: 9.55 mm
 Trefferlage: 1.19 mm rechts, 0.15 mm tief

Ergebnis: 390.5 (374)
Serien: 97.3 94.9 98.0 100.3
Zähler: 20 15 4 1 0 0 0 0 0 0
Innenzehner: 13
Weiteste: 988 (15.), 750 (20.), 689 (8.)
beste Teiler: 36.1 (38.), 39.2 (34.), 45.3 (23.)
Trefferkreis: 20.92 mm
Trefferlage: 0.18 mm links, 0.02 mm tief

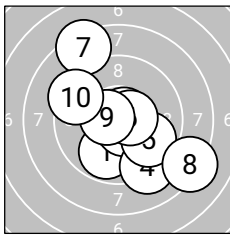
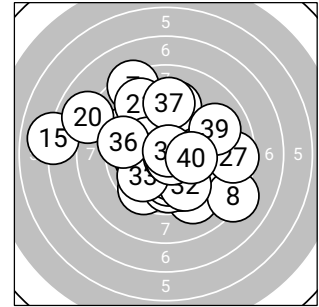

Serie 1: 97.3 (92)
 9.9 ↘ 10.7* ↗ 10.6* ↘ 9.2 ↘ 9.8 ↘
 10.6* → 8.3 ↗ 8.2 ↘ 10.6* ← 9.4 ←
beste Teiler: 60.3 (2.), 86.2 (3.), 93.9 (9.)
Trefferkreis: 17.40 mm
Trefferlage: 0.43 mm rechts, 0.38 mm tief

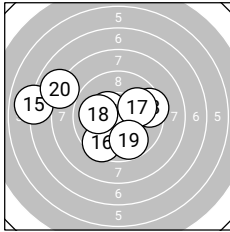

Serie 2: 94.9 (92)
 10.6* ↖ 10.1 ↓ 9.5 → 10.4* ← 7.0 ←
 9.5 ↖ 10.0 → 10.0 ← 9.8 ↓ 8.0 ←
beste Teiler: 84.8 (11.), 137.7 (14.), 208.8 (12.)
Trefferkreis: 17.89 mm
Trefferlage: 1.50 mm links, 0.09 mm tief

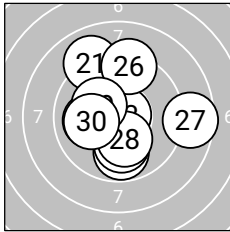

Serie 3: 98.0 (95)
 9.0 ↗ 9.8 ↓ 10.8* ↗ 10.0 ↓ 10.0 ←
 9.3 ↑ 8.6 → 10.2* ↓ 10.2* ← 10.1 ←
beste Teiler: 45.3 (23.), 182.6 (29.), 186.1 (28.)
Trefferkreis: 13.83 mm
Trefferlage: 0.00 mm, 0.17 mm hoch

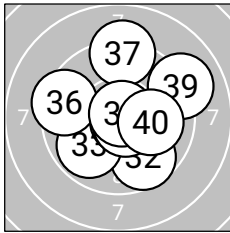

Serie 4: 100.3 (95)
 10.7* ← 9.7 ↘ 9.9 ↖ 10.8* ↘ 10.7* ↘
 9.4 ← 9.2 ↑ 10.8* ↗ 9.0 → 10.1 →
beste Teiler: 36.1 (38.), 39.2 (34.), 65.9 (35.)
Trefferkreis: 12.59 mm
Trefferlage: 0.32 mm rechts, 0.19 mm hoch



LG 40 ZR

StandNr: 125

Sprenger, Lea-Sophie #70818375

Jungschützinnen

Wertung

StartNr: 25

08.03.2026 09:37

SG_Eben

SG Eben 1

Ergebnis: **401.6** (380)
 Serien: 101.6 98.3 101.5 100.2
 Zähler: 20 20 0 0 0 0 0 0 0 0
 Innenzehner: 17
 Weitester: 459 (27.), 441 (12.), 400 (38.)
 beste Teiler: 44.9 (26.), 52.0 (29.), 67.0 (31.)
 Trefferkreis: 12.70 mm
 Trefferlage: 0.02 mm links, 0.29 mm hoch

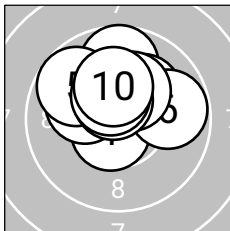
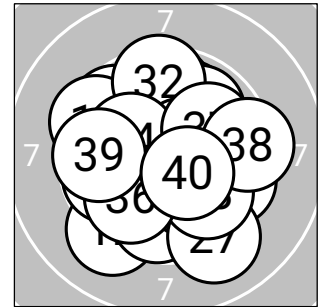

Serie 1: 101.6 (97)

10.6*↙	10.1↖	9.7↑	10.2*↗	9.8↘
9.8→	10.3*↗	10.5*↑	10.4*↖	10.2*↑

beste Teiler: 81.8 (1.), 109.8 (8.), 138.1 (9.)
 Trefferkreis: 9.85 mm
 Trefferlage: 0.07 mm links, 1.28 mm hoch

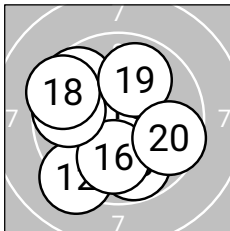

Serie 2: 98.3 (93)

10.3*↖	9.2↙	9.8↓	9.7↖	10.6*↗
10.0↓	9.7↖	9.5↖	9.9↗	9.6→

beste Teiler: 93.2 (15.), 170.0 (11.), 236.7 (16.)
 Trefferkreis: 11.79 mm
 Trefferlage: 0.70 mm links, 0.11 mm tief

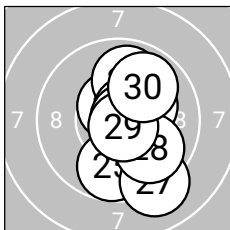

Serie 3: 101.5 (95)

10.6*↖	9.9↑	10.6*↗	10.2*↗	9.8↓
10.8*→	9.1↓	9.9↘	10.7*↘	9.9↗

beste Teiler: 44.9 (26.), 52.0 (29.), 87.0 (23.)
 Trefferkreis: 11.24 mm
 Trefferlage: 0.86 mm rechts, 0.19 mm tief

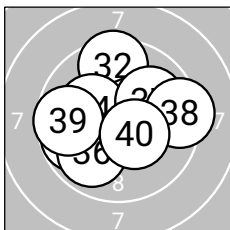

Serie 4: 100.2 (95)

10.7*↓	9.5↑	10.6*↗	10.2*↖	9.8↖
9.9↙	10.0↗	9.4→	9.7↖	10.4*↘

beste Teiler: 67.0 (31.), 100.1 (33.), 136.3 (40.)
 Trefferkreis: 11.73 mm
 Trefferlage: 0.17 mm links, 0.20 mm hoch



Ergebnis: 397.0 (380)
Serien: 99.2 98.2 100.7 98.9
Zähler: 25 14 0 0 0 0 1 0 0 0 0
Innenzehner: 17
Weiteste: 1546 (16.), 496 (40.), 492 (2.)
beste Teiler: 32.3 (18.), 33.8 (3.), 47.0 (36.)
Trefferkreis: 24.46 mm
Trefferlage: 0.17 mm rechts, 0.55 mm hoch

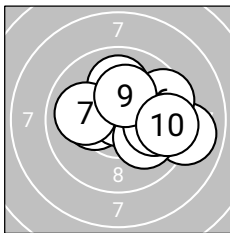
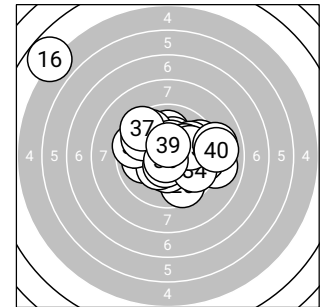

Serie 1: 99.2 (96)

10.3*← 9.0→ 10.8*↑ 10.0↑ 10.0↘
 9.5↗ 10.0← 9.9→ 10.2*↑ 9.5→
beste Teiler: 33.8 (3.), 169.1 (1.), 179.4 (9.)
Trefferkreis: 11.81 mm
Trefferlage: 1.26 mm rechts, 0.33 mm hoch

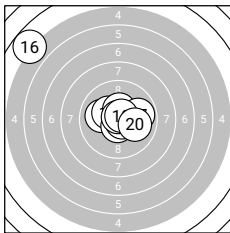

Serie 2: 98.2 (93)

10.0← 10.3*↖ 10.6*↓ 10.7*↘ 10.4*↑
 4.8↖ 9.9→ 10.8*↑ 10.7*↗ 10.0→
beste Teiler: 32.3 (18.), 64.0 (14.), 64.5 (19.)
Trefferkreis: 22.16 mm
Trefferlage: 0.97 mm links, 1.19 mm hoch

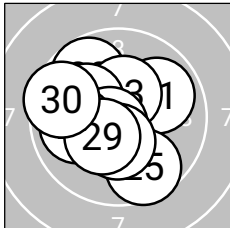

Serie 3: 100.7 (96)

9.9↗ 9.7↖ 10.4*↑ 10.1↖ 9.6↘
 10.7*↖ 10.0← 10.4*↓ 10.4*↖ 9.5←
beste Teiler: 69.3 (26.), 141.6 (23.), 146.0 (28.)
Trefferkreis: 10.96 mm
Trefferlage: 0.68 mm links, 0.05 mm hoch

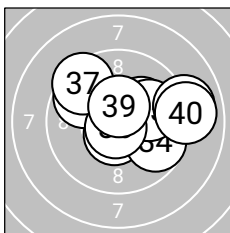

Serie 4: 98.9 (95)

10.6*↓ 9.7↖ 10.2*↗ 9.7↘ 10.0→
 10.8*↓ 9.4↖ 9.0→ 10.5*↑ 9.0→
beste Teiler: 47.0 (36.), 97.1 (31.), 111.1 (39.)
Trefferkreis: 12.30 mm
Trefferlage: 1.08 mm rechts, 0.65 mm hoch



LG 40 ZR

StandNr: 127

Wöll, Sarah #70818702

Jungschützinnen

Wertung

StartNr: 27

08.03.2026 09:21

SG_Eben

SG Eben 1

Ergebnis: **398.1** (381)
 Serien: 99.6 100.1 97.9 100.5
 Zähler: 22 17 1 0 0 0 0 0 0 0 0
 Innenzehner: 17
 Weitester: 609 (3.), 500 (25.), 496 (11.)
 beste Teiler: 45.2 (40.), 49.0 (8.), 61.2 (31.)
 Trefferkreis: 15.31 mm
 Trefferlage: 0.36 mm links, 0.01 mm tief

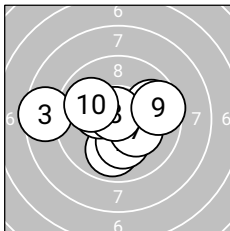
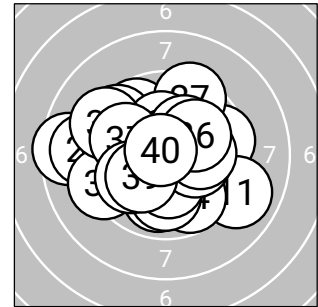

Serie 1: 99.6 (94)
 9.9↓ 10.2*↓ 8.5← 10.3*← 10.3*↘
 9.8→ 10.3*↘ 10.8*↖ 9.6→ 9.9↖
 beste Teiler: 49.0 (8.), 162.8 (5.), 164.7 (4.)
 Trefferkreis: 13.92 mm
 Trefferlage: 0.12 mm links, 0.15 mm tief

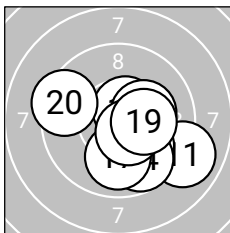

Serie 2: 100.1 (97)
 9.0↘ 10.3*↘ 10.0↘ 9.8↓ 10.6*↗
 10.2*→ 10.0↓ 10.5*↘ 10.3*→ 9.4←

beste Teiler: 90.7 (15.), 106.4 (18.), 166.9 (12.)
 Trefferkreis: 13.30 mm
 Trefferlage: 0.96 mm rechts, 0.85 mm tief

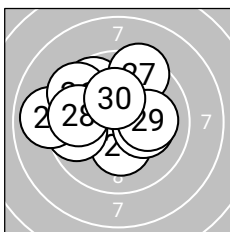

Serie 3: 97.9 (94)
 10.3*↓ 10.2*→ 9.7← 9.7↖ 9.0←
 9.5↖ 9.4↗ 9.8← 10.1→ 10.2*↑

beste Teiler: 170.0 (21.), 176.0 (30.), 188.0 (22.)
 Trefferkreis: 11.91 mm
 Trefferlage: 1.03 mm links, 0.81 mm hoch

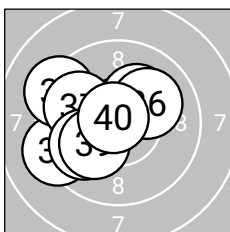

Serie 4: 100.5 (96)
 10.7*↑ 10.2*← 9.3← 9.3↖ 10.2*↗
 10.1↗ 9.9← 9.9← 10.1↖ 10.8*↖

beste Teiler: 45.2 (40.), 61.2 (31.), 179.9 (32.)
 Trefferkreis: 10.96 mm
 Trefferlage: 1.28 mm links, 0.15 mm hoch



Ergebnis: **397.0** (379)
Serien: 101.8 98.2 96.8 100.2
Zähler: 23 14 2 1 0 0 0 0 0 0
Innenzehner: 14
Weiteste: 752 (28.), 565 (25.), 506 (20.)
beste Teiler: 73.1 (10.), 88.0 (23.), 100.4 (39.)
Trefferkreis: 15.35 mm
Trefferlage: 0.57 mm rechts, 0.26 mm tief

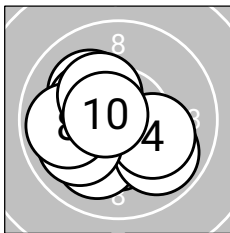
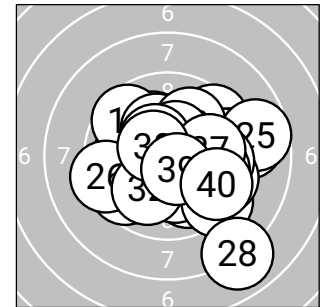

Serie 1: 101.8 (98)

10.4* \downarrow 10.1 \swarrow 9.9 \searrow 10.1 \searrow 10.1 \swarrow
 10.0 \swarrow 10.3* \swarrow 9.9 \swarrow 10.3* \swarrow 10.7* \swarrow

beste Teiler: 73.1 (10.), 150.1 (1.), 163.6 (9.)
Trefferkreis: 9.45 mm
Trefferlage: 0.66 mm links, 0.37 mm tief

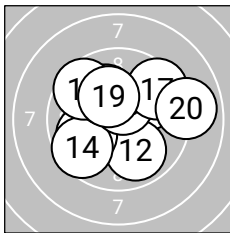

Serie 2: 98.2 (93)

10.0 \nearrow 9.9 \searrow 9.9 \swarrow 9.6 \swarrow 10.1 \swarrow
 10.5* \nearrow 9.5 \nearrow 9.6 \swarrow 10.2* \swarrow 8.9 \rightarrow

beste Teiler: 116.3 (16.), 181.4 (19.), 203.0 (15.)
Trefferkreis: 12.78 mm
Trefferlage: 0.23 mm rechts, 0.57 mm hoch

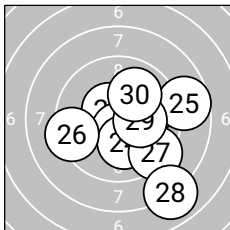

Serie 3: 96.8 (93)

10.5* \swarrow 10.1 \rightarrow 10.6* \downarrow 10.2* \downarrow 8.7 \rightarrow
 9.3 \swarrow 9.3 \searrow 7.9 \searrow 10.2* \rightarrow 10.0 \nearrow

beste Teiler: 88.0 (23.), 112.4 (21.), 182.3 (29.)
Trefferkreis: 14.98 mm
Trefferlage: 1.41 mm rechts, 0.86 mm tief

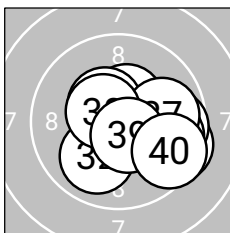

Serie 4: 100.2 (95)

9.5 \searrow 10.0 \swarrow 10.4* \nearrow 10.4* \swarrow 9.7 \rightarrow
 9.7 \searrow 9.9 \rightarrow 10.5* \swarrow 10.6* \searrow 9.5 \searrow

beste Teiler: 100.4 (39.), 109.0 (38.), 128.8 (34.)
Trefferkreis: 9.60 mm
Trefferlage: 1.32 mm rechts, 0.40 mm tief



Ergebnis: 403.2 (384)
Serien: 99.7 100.7 102.1 100.7
Zähler: 25 14 1 0 0 0 0 0 0 0
Innenzehner: 19
Weiteste: 556 (39.), 443 (20.), 404 (5.)
beste Teiler: 43.1 (34.), 49.0 (3.), 57.2 (23.)
Trefferkreis: 14.41 mm
Trefferlage: 0.41 mm links, 0.26 mm hoch

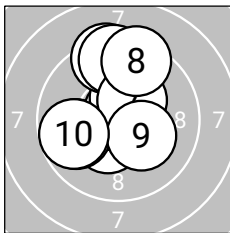
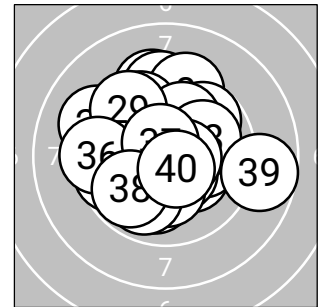

Serie 1: 99.7 (95)
 10.4*↙ 9.8↙ 10.8*↑ 10.4*↑ 9.3↑
 9.4↑ 10.3*↗ 9.4↑ 10.2*↘ 9.7↙
beste Teiler: 49.0 (3.), 138.3 (1.), 148.4 (4.)
Trefferkreis: 10.73 mm
Trefferlage: 0.34 mm links, 1.07 mm hoch

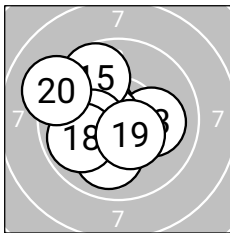

Serie 2: 100.7 (97)
 10.1↖ 10.4*↖ 10.1→ 10.6*← 9.7↖
 10.0↓ 10.3*← 9.9↙ 10.4*↘ 9.2↖
beste Teiler: 81.0 (14.), 126.0 (19.), 130.1 (12.)
Trefferkreis: 11.00 mm
Trefferlage: 1.09 mm links, 0.15 mm hoch

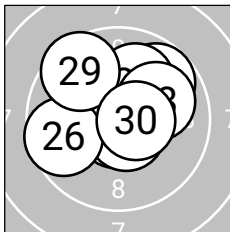

Serie 3: 102.1 (97)
 9.8↗ 10.7*↗ 10.7*↓ 10.6*↘ 10.6*↗
 9.6↙ 10.0↗ 10.0→ 9.6↖ 10.5*→
beste Teiler: 57.2 (23.), 72.6 (22.), 84.9 (24.)
Trefferkreis: 10.62 mm
Trefferlage: 0.23 mm rechts, 0.67 mm hoch

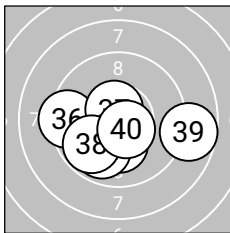

Serie 4: 100.7 (95)
 10.2*↓ 9.9↙ 10.1↙ 10.8*← 10.6*←
 9.4← 10.6*↖ 9.8↙ 8.7→ 10.6*↘
beste Teiler: 43.1 (34.), 84.0 (35.), 85.2 (37.)
Trefferkreis: 14.00 mm
Trefferlage: 0.45 mm links, 0.82 mm tief



Ergebnis: 397.7 (382)
Serien: 99.0 97.0 100.1 101.6
Zähler: 25 13 1 1 0 0 0 0 0 0
Innenzehner: 18
Weiteste: 789 (18.), 536 (16.), 499 (10.)
beste Teiler: 76.0 (32.), 88.1 (19.), 104.6 (1.)
Trefferkreis: 17.03 mm
Trefferlage: 0.00 mm , 0.53 mm tief

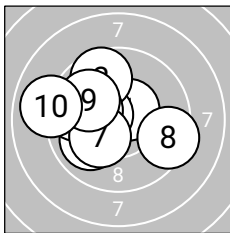
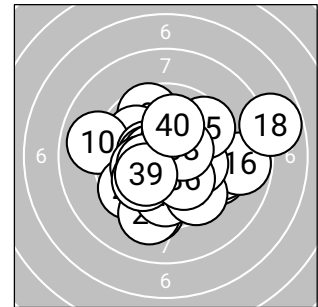

Serie 1: 99.0 (95)

10.5*↗	10.5*↖	9.7↖	10.0↖	10.1↖
9.7↖	10.2*↖	9.4↗	9.9↖	9.0↖

beste Teiler: 104.6 (1.), 122.4 (2.), 180.4 (7.)
Trefferkreis: 13.34 mm
Trefferlage: 1.34 mm links, 0.39 mm hoch

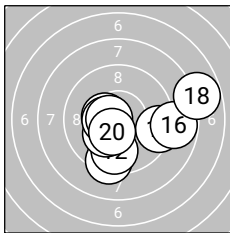

Serie 2: 97.0 (92)

9.3↓	9.7↓	9.3↗	10.4*↖	10.2*↖
8.8↗	10.5*↖	7.8↗	10.6*↖	10.4*↖

beste Teiler: 88.1 (19.), 125.1 (17.), 132.2 (14.)
Trefferkreis: 15.01 mm
Trefferlage: 1.03 mm rechts, 0.85 mm tief

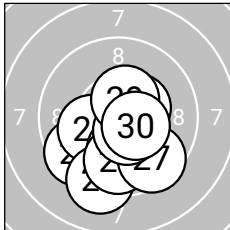

Serie 3: 100.1 (96)

9.5↖	10.2*↖	9.2↓	10.1↓	9.8↓
10.4*↗	9.5↘	10.5*↘	10.5*↗	10.4*↗

beste Teiler: 107.9 (28.), 123.4 (29.), 128.7 (30.)
Trefferkreis: 10.03 mm
Trefferlage: 0.01 mm rechts, 1.46 mm tief

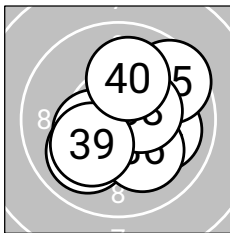

Serie 4: 101.6 (99)

10.0↖	10.6*↗	10.3*↖	10.0↗	9.6↗
10.1↘	10.4*↖	10.4*↗	10.2*↖	10.0↗

beste Teiler: 76.0 (32.), 129.8 (38.), 144.4 (37.)
Trefferkreis: 10.30 mm
Trefferlage: 0.32 mm rechts, 0.21 mm tief



Ergebnis: 411.6 (393)
Serien: 103.0 102.9 103.6 102.1
Zähler: 33 7 0 0 0 0 0 0 0 0
Innenzehner: 27
Weiteste: 368 (2.), 364 (33.), 277 (18.)
beste Teiler: 9.0 (16.), 34.4 (10.), 38.8 (9.)
Trefferkreis: 11.81 mm
Trefferlage: 0.09 mm links, 0.29 mm tief

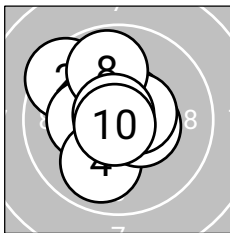
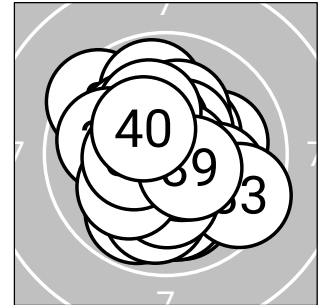

Serie 1: 103.0 (97)

10.4*↙	9.5↖	10.3*←	9.9↙	10.6*↗
10.4*→	10.5*→	9.8↑	10.8*↖	10.8*↙

beste Teiler: 34.4 (10.), 38.8 (9.), 84.2 (5.)
Trefferkreis: 9.66 mm
Trefferlage: 0.48 mm links, 0.20 mm hoch

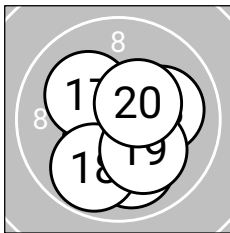

Serie 2: 102.9 (99)

10.4*↓	10.6*↓	10.1→	10.0↓	10.4*↙
10.9*←	10.2*↖	9.8↙	10.1↘	10.4*↗

beste Teiler: 9.0 (16.), 86.4 (12.), 127.4 (15.)
Trefferkreis: 9.21 mm
Trefferlage: 0.18 mm rechts, 0.70 mm tief

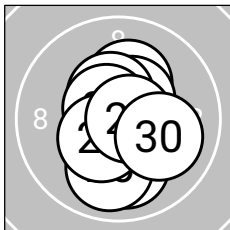

Serie 3: 103.6 (99)

10.2*↗	10.8*↓	10.0↓	10.5*↗	9.9↓
10.5*↖	10.6*↖	10.4*↙	10.7*→	10.0→

beste Teiler: 46.1 (22.), 57.0 (29.), 82.8 (27.)
Trefferkreis: 8.89 mm
Trefferlage: 0.19 mm rechts, 0.26 mm tief

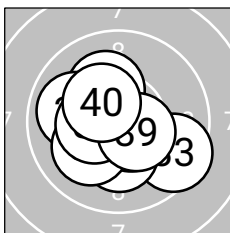

Serie 4: 102.1 (98)

10.2*↖	10.3*↙	9.5↘	10.2*↓	9.9←
10.6*↘	10.1↙	10.4*←	10.5*↘	10.4*↖

beste Teiler: 94.2 (36.), 120.0 (39.), 137.9 (38.)
Trefferkreis: 10.62 mm
Trefferlage: 0.28 mm links, 0.42 mm tief



Ergebnis: **402.6 (383)**
 Serien: 99.9 100.9 102.3 99.5
 Zähler: 25 13 2 0 0 0 0 0 0 0
 Innenzehner: 22
 Weitester: 581 (39.), 511 (9.), 447 (24.)
 beste Teiler: 64.6 (33.), 66.7 (21.), 69.3 (2.)
 Trefferkreis: 14.55 mm
 Trefferlage: 0.38 mm rechts, 0.10 mm hoch

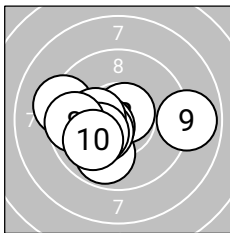
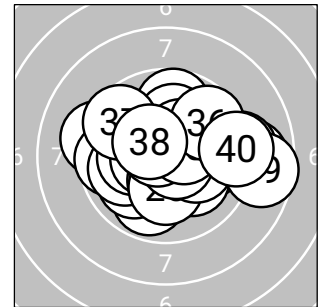

Serie 1: 99.9 (95)
 9.9 ↓ 10.7* ↗ 10.5* ← 9.3 ← 10.4* ↙
 10.3* ← 10.3* ← 9.6 ← 8.9 → 10.0 ↙
 beste Teiler: 69.3 (2.), 115.3 (3.), 143.0 (5.)
 Trefferkreis: 13.79 mm
 Trefferlage: 0.99 mm links, 0.49 mm tief

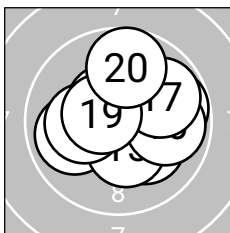

Serie 2: 100.9 (95)
 9.9 ← 10.2* ↘ 9.8 → 10.5* ↖ 10.3* ↓
 9.9 → 9.9 → 10.2* ← 10.5* ← 9.7 ↑
 beste Teiler: 103.3 (19.), 115.1 (14.), 151.5 (15.)
 Trefferkreis: 10.01 mm
 Trefferlage: 0.43 mm rechts, 0.26 mm hoch

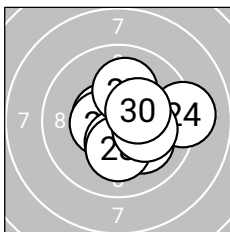

Serie 3: 102.3 (99)
 10.7* ↑ 10.6* ← 10.1 ↘ 9.2 → 10.5* ←
 10.4* ↓ 10.1 ↑ 10.2* ↓ 10.2* → 10.3* →
 beste Teiler: 66.7 (21.), 99.0 (22.), 111.1 (25.)
 Trefferkreis: 10.08 mm
 Trefferlage: 0.76 mm rechts, 0.12 mm tief

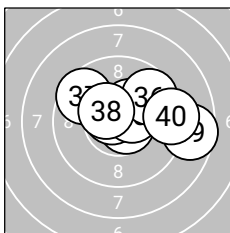

Serie 4: 99.5 (94)
 9.7 ↗ 10.7* ↘ 10.7* ↖ 10.4* ↗ 10.5* ↗
 9.7 ↗ 9.6 ↖ 10.4* ↖ 8.6 → 9.2 →
 beste Teiler: 64.6 (33.), 72.4 (32.), 122.9 (35.)
 Trefferkreis: 13.48 mm
 Trefferlage: 1.35 mm rechts, 0.77 mm hoch



Ergebnis: 356.7 (339)
Serien: 86.9 90.1 89.5 90.2
Zähler: 7 12 16 4 0 1 0 0 0 0 0
Innenzehner: 5
Weiteste: 1348 (35.), 942 (20.), 816 (10.)
beste Teiler: 100.6 (40.), 112.8 (11.), 121.0 (17.)
Trefferkreis: 25.51 mm
Trefferlage: 0.00 mm , 1.91 mm hoch

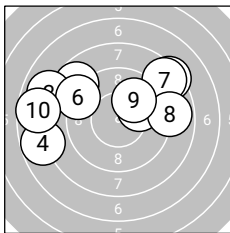
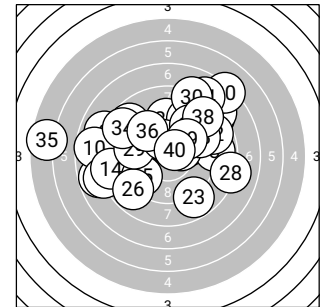

Serie 1: 86.9 (82)

8.3 ↗ 8.7 ↘ 8.0 ← 7.8 ← 10.0 ↗
 9.1 ↘ 8.5 ↗ 8.9 → 9.9 ↗ 7.7 ←

beste Teiler: 237.4 (5.), 252.5 (9.), 467.3 (6.)
Trefferkreis: 18.79 mm
Trefferlage: 1.23 mm links, 1.89 mm hoch

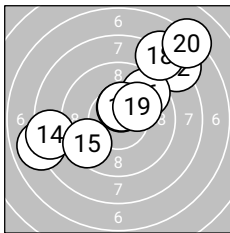

Serie 2: 90.1 (87)

10.5* ↑ 8.1 ↗ 8.0 ← 8.4 ← 9.5 ↘
 9.6 ↗ 10.5* ↑ 8.2 ↗ 10.1 ↗ 7.2 ↗

beste Teiler: 112.8 (11.), 121.0 (17.), 209.1 (19.)
Trefferkreis: 20.87 mm
Trefferlage: 0.40 mm rechts, 1.75 mm hoch

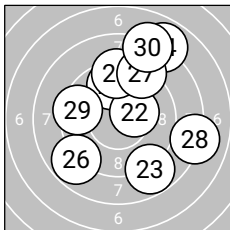

Serie 3: 89.5 (85)

9.7 ↑ 10.3* ↗ 8.8 ↘ 7.9 ↗ 9.3 ↑
 8.8 ↘ 9.1 ↗ 8.1 → 9.4 ← 8.1 ↗

beste Teiler: 158.6 (22.), 316.1 (21.), 378.9 (29.)
Trefferkreis: 17.56 mm
Trefferlage: 1.18 mm rechts, 1.57 mm hoch

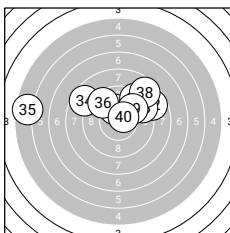

Serie 4: 90.2 (85)

10.2* ↑ 8.7 ↗ 9.3 ↗ 8.6 ↘ 5.6 ←
 9.5 ↘ 9.3 ↗ 8.6 ↗ 9.8 ↗ 10.6* ↗

beste Teiler: 100.6 (40.), 187.9 (31.), 281.9 (39.)
Trefferkreis: 22.86 mm
Trefferlage: 0.33 mm links, 2.42 mm hoch



Ergebnis: 404.8 (387)
Serien: 102.0 102.3 101.2 99.3
Zähler: 28 11 1 0 0 0 0 0 0 0
Innenzehner: 25
Weiteste: 691 (23.), 490 (39.), 457 (18.)
beste Teiler: 17.0 (16.), 42.7 (21.), 50.3 (3.)
Trefferkreis: 16.07 mm
Trefferlage: 0.08 mm rechts, 0.13 mm hoch

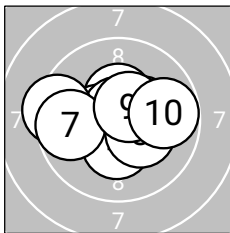
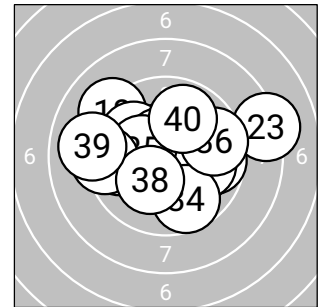

Serie 1: 102.0 (97)

10.4*↑	10.5*←	10.8*↑	10.3*↓	10.3*→
9.4←	9.7←	10.3*↘	10.5*↗	9.8→

beste Teiler: 50.3 (3.), 106.5 (9.), 123.0 (2.)
Trefferkreis: 11.33 mm
Trefferlage: 0.19 mm links, 0.15 mm hoch

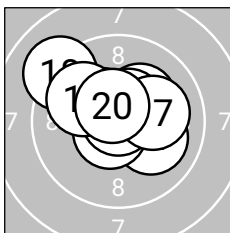

Serie 2: 102.3 (98)

10.1↘	10.2*↗	10.4*↖	10.5*↗	10.6*↖
10.9*↑	10.1→	9.1↖	9.9↖	10.5*↖

beste Teiler: 17.0 (16.), 80.4 (15.), 101.0 (20.)
Trefferkreis: 11.24 mm
Trefferlage: 0.15 mm links, 0.74 mm hoch

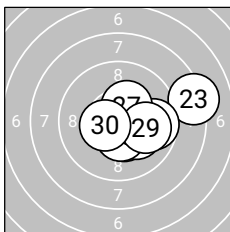

Serie 3: 101.2 (97)

10.8*↗	10.4*↘	8.2→	9.7→	10.2*↘
10.6*↗	10.4*↗	10.4*↓	10.0→	10.5*←

beste Teiler: 42.7 (21.), 99.8 (26.), 123.3 (30.)
Trefferkreis: 12.64 mm
Trefferlage: 1.51 mm rechts, 0.09 mm tief

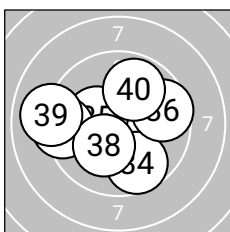

Serie 4: 99.3 (95)

10.5*←	10.2*↖	10.6*↖	9.7↘	10.3*←
9.6→	9.3←	10.2*↖	9.0←	9.9↗

beste Teiler: 99.7 (33.), 105.0 (31.), 162.3 (35.)
Trefferkreis: 12.57 mm
Trefferlage: 0.85 mm links, 0.25 mm tief



Ergebnis: 395.1 (376)
Serien: 99.6 97.6 99.9 98.0
Zähler: 19 18 3 0 0 0 0 0 0 0
Innenzehner: 16
Weiteste: 648 (13.), 548 (35.), 502 (40.)
beste Teiler: 87.3 (38.), 91.0 (1.), 94.6 (23.)
Trefferkreis: 13.40 mm
Trefferlage: 1.63 mm links, 0.24 mm hoch

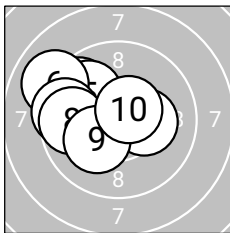
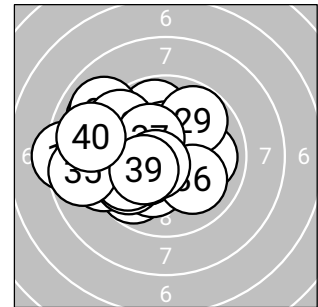

Serie 1: 99.6 (95)

10.6*→	10.1↖	9.7↖	10.3*→	9.9↖
9.0↖	9.5↖	9.7↖	10.2*↖	10.6*↖

beste Teiler: 91.0 (1.), 97.5 (10.), 173.6 (4.)
Trefferkreis: 11.00 mm
Trefferlage: 1.53 mm links, 0.69 mm hoch

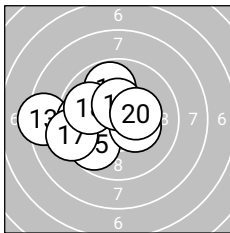

Serie 2: 97.6 (92)

9.7↖	9.8↑	8.4↖	9.7↖	9.8↖
10.3*→	9.3↖	9.9↖	10.4*↑	10.3*→

beste Teiler: 130.1 (19.), 157.0 (16.), 159.7 (20.)
Trefferkreis: 12.52 mm
Trefferlage: 1.88 mm links, 0.00 mm

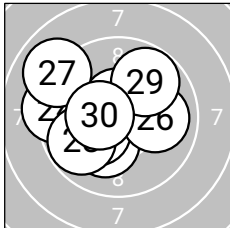

Serie 3: 99.9 (96)

10.2*↙	10.4*↗	10.6*↑	9.3↖	10.3*↖
10.0→	9.0↖	9.8↖	9.8↗	10.5*↖

beste Teiler: 94.6 (23.), 123.4 (30.), 128.4 (22.)
Trefferkreis: 11.60 mm
Trefferlage: 0.92 mm links, 0.35 mm hoch

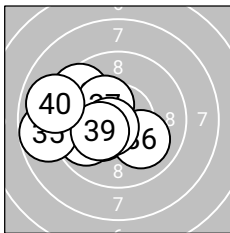

Serie 4: 98.0 (93)

9.5↖	9.5↖	10.3*↖	9.8↖	8.8↖
10.0↘	10.3*↖	10.6*↖	10.3*↖	8.9↖

beste Teiler: 87.3 (38.), 154.3 (37.), 162.0 (33.)
Trefferkreis: 11.74 mm
Trefferlage: 2.19 mm links, 0.08 mm tief



Ergebnis: 387.7 (369)
Serien: 96.8 97.7 98.9 94.3
Zähler: 15 19 6 0 0 0 0 0 0 0
Innenzehner: 10
Weiteste: 583 (2.), 580 (15.), 567 (19.)
beste Teiler: 21.9 (24.), 47.8 (20.), 65.8 (14.)
Trefferkreis: 16.00 mm
Trefferlage: 0.23 mm rechts, 0.37 mm tief

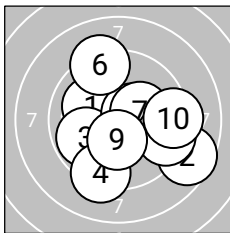
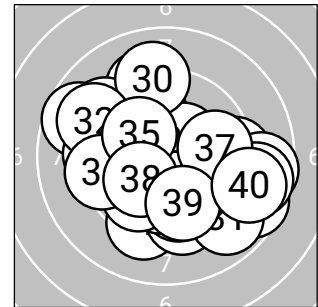

Serie 1: 96.8 (93)

10.1↖	8.6➡	9.8↖	9.3↘	10.5*➡
9.2↗	10.3*➡	9.4➡	10.3*↘	9.3➡

beste Teiler: 107.3 (5.), 152.2 (9.), 174.0 (7.)
Trefferkreis: 14.13 mm
Trefferlage: 0.82 mm rechts, 0.43 mm tief

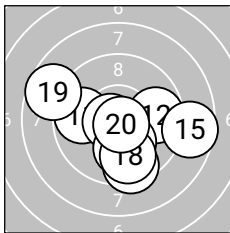

Serie 2: 97.7 (92)

9.8↖	9.7➡	10.2*↘	10.7*↖	8.6➡
9.4↘	10.0↘	9.8↘	8.7↖	10.8*↘

beste Teiler: 47.8 (20.), 65.8 (14.), 199.3 (13.)
Trefferkreis: 15.89 mm
Trefferlage: 0.30 mm rechts, 0.93 mm tief

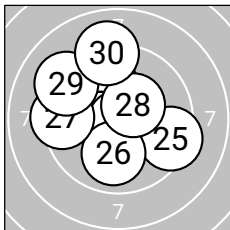

Serie 3: 98.9 (95)

10.2*↖	10.4*↖	9.9↗	10.9*↘	9.4➡
10.0↘	9.4↖	10.4*➡	9.2↖	9.1↗

beste Teiler: 21.9 (24.), 141.0 (22.), 142.2 (28.)
Trefferkreis: 12.80 mm
Trefferlage: 0.70 mm links, 0.91 mm hoch

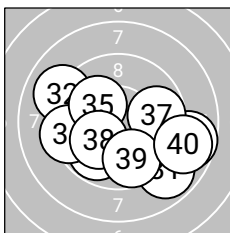

Serie 4: 94.3 (89)

8.9➡	9.0↖	9.8↘	9.4↖	10.1↖
8.7➡	9.8➡	10.1↖	9.7↘	8.8➡

beste Teiler: 205.3 (35.), 206.5 (38.), 281.6 (33.)
Trefferkreis: 14.88 mm
Trefferlage: 0.51 mm rechts, 1.04 mm tief



Ergebnis: 401.0 (385)
Serien: 100.9 100.8 100.7 98.6
Zähler: 27 11 2 0 0 0 0 0 0 0
Innenzehner: 19
Weiteste: 671 (36.), 566 (15.), 408 (37.)
beste Teiler: 57.0 (12.), 60.3 (39.), 85.3 (40.)
Trefferkreis: 13.98 mm
Trefferlage: 1.07 mm rechts, 0.03 mm tief

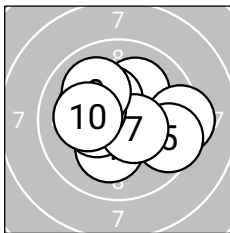
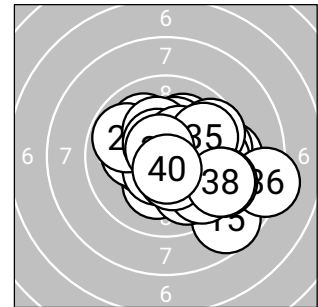

Serie 1: 100.9 (98)

10.1 ↗	10.4* ↖	9.3 →	10.2* ↓	9.6 ↘
10.4* ↖	10.5* ↘	10.2* ↖	10.0 ↖	10.2* ↖

beste Teiler: 117.3 (7.), 139.4 (6.), 143.1 (2.)
Trefferkreis: 10.54 mm
Trefferlage: 0.17 mm rechts, 0.19 mm hoch

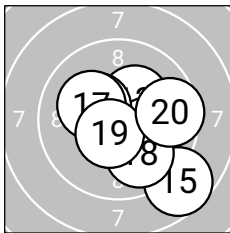

Serie 2: 100.8 (96)

10.5* ↓	10.7* ↓	10.3* ↗	10.1 ↘	8.7 ↘
10.3* ↖	10.2* ↖	9.9 ↘	10.5* ↖	9.6 →

beste Teiler: 57.0 (12.), 101.8 (11.), 108.5 (19.)
Trefferkreis: 12.08 mm
Trefferlage: 0.77 mm rechts, 0.60 mm tief

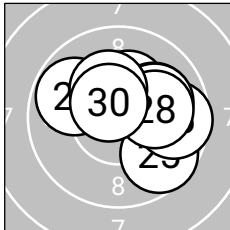

Serie 3: 100.7 (97)

10.3* ↗	10.1 →	9.8 ↖	10.1 →	9.7 ↘
9.7 →	10.0 →	10.1 →	10.3* ↖	10.6* ↖

beste Teiler: 99.5 (30.), 170.1 (21.), 171.1 (29.)
Trefferkreis: 10.53 mm
Trefferlage: 1.09 mm rechts, 0.51 mm hoch

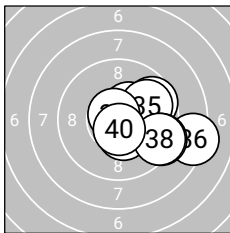

Serie 4: 98.6 (94)

10.4* ↗	9.6 ↗	10.0 →	10.4* ↓	9.9 ↗
8.3 →	9.3 ↘	9.4 ↘	10.7* ↖	10.6* ↓

beste Teiler: 60.3 (39.), 85.3 (40.), 135.3 (31.)
Trefferkreis: 11.71 mm
Trefferlage: 2.24 mm rechts, 0.26 mm tief



Ergebnis: **411.1 (389)**
 Serien: 102.6 103.1 103.0 102.4
 Zähler: 29 11 0 0 0 0 0 0 0 0
 Innenzehner: 24
 Weitester: 441 (19.), 355 (34.), 350 (8.)
 beste Teiler: 11.1 (32.), 14.4 (14.), 23.1 (12.)
 Trefferkreis: 11.94 mm
 Trefferlage: 0.51 mm links, 0.08 mm tief

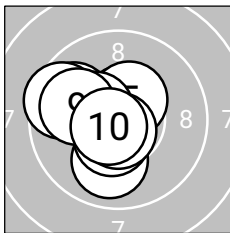
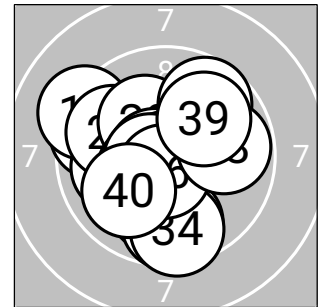

Serie 1: 102.6 (97)

10.6*↑	10.0↓	9.8↙	10.5*↓	10.4*↑
10.4*↙	10.7*↓	9.6↙	9.9↙	10.7*↙

beste Teiler: 64.0 (7.), 68.8 (10.), 98.2 (1.)
 Trefferkreis: 9.24 mm
 Trefferlage: 1.02 mm links, 0.12 mm hoch

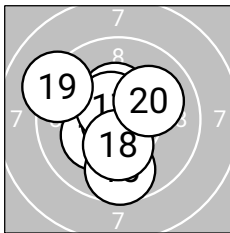

Serie 2: 103.1 (98)

10.8*↙	10.9*→	10.3*↙	10.9*↙	9.7↓
10.4*↑	10.6*↙	10.3*↓	9.2↙	10.0↗

beste Teiler: 14.4 (14.), 23.1 (12.), 42.2 (11.)
 Trefferkreis: 11.33 mm
 Trefferlage: 0.41 mm links, 0.08 mm tief

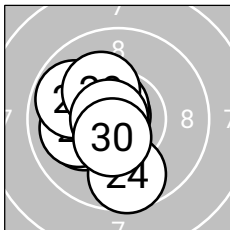

Serie 3: 103.0 (98)

10.6*↙	10.8*↙	10.1↙	9.7↓	10.0↙
9.8↙	10.6*↙	10.2*↙	10.7*↙	10.5*↓

beste Teiler: 43.3 (22.), 53.0 (29.), 79.8 (27.)
 Trefferkreis: 9.79 mm
 Trefferlage: 0.96 mm links, 0.12 mm tief

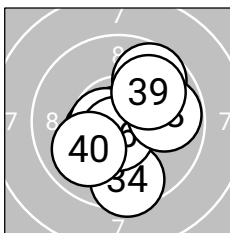

Serie 4: 102.4 (96)

10.5*↙	10.9*↓	10.8*↙	9.5↓	10.6*↙
10.7*↓	9.7↗	9.8→	9.9↗	10.0↙

beste Teiler: 11.1 (32.), 28.8 (33.), 74.4 (36.)
 Trefferkreis: 10.66 mm
 Trefferlage: 0.32 mm rechts, 0.24 mm tief



Ergebnis: 400.1 (380)
Serien: 99.3 99.5 100.1 101.2
Zähler: 21 18 1 0 0 0 0 0 0 0
Innenzehner: 17
Weiteste: 634 (16.), 452 (30.), 420 (31.)
beste Teiler: 48.1 (27.), 63.6 (14.), 83.0 (35.)
Trefferkreis: 14.11 mm
Trefferlage: 0.35 mm links, 0.14 mm tief

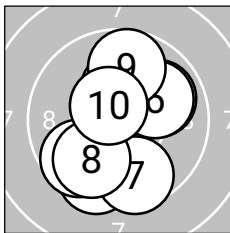
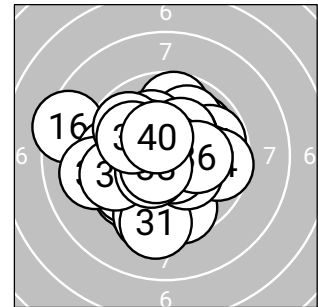

Serie 1: 99.3 (94)

9.9➔	9.6↙	9.7↙	10.3*↑	10.0↙
10.0➔	9.6↘	9.9↙	9.7↑	10.6*↖
beste Teiler: 98.4 (10.), 175.1 (4.), 231.1 (5.)				
Trefferkreis: 10.99 mm				
Trefferlage: 0.06 mm links, 0.51 mm tief				

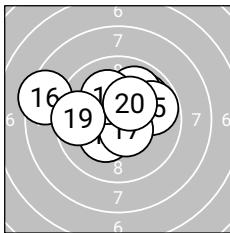

Serie 2: 99.5 (94)

10.3*↙	9.9➔	9.9➔	10.7*↗	9.8➔
8.4↖	10.5*↘	10.1↖	9.6↖	10.3*↗
beste Teiler: 63.6 (14.), 105.6 (17.), 163.0 (20.)				
Trefferkreis: 13.36 mm				
Trefferlage: 0.32 mm links, 0.80 mm hoch				

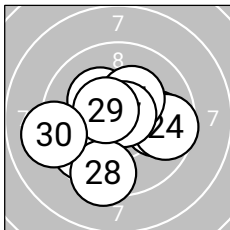

Serie 3: 100.1 (95)

9.9➔	9.7↙	10.6*↖	9.6➔	10.2*↖
10.3*↗	10.8*↗	9.4↘	10.5*↖	9.1↖
beste Teiler: 48.1 (27.), 84.0 (23.), 104.0 (29.)				
Trefferkreis: 12.15 mm				
Trefferlage: 0.35 mm links, 0.40 mm tief				

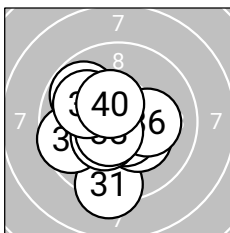

Serie 4: 101.2 (97)

9.3↘	9.6↖	9.8↖	10.3*↘	10.6*↘
10.2*➔	10.4*↙	10.6*↙	10.0↖	10.4*↖
beste Teiler: 83.0 (35.), 92.0 (38.), 128.8 (40.)				
Trefferkreis: 10.70 mm				
Trefferlage: 0.65 mm links, 0.47 mm tief				



Ergebnis: 379.4 (359)
Serien: 93.3 94.9 97.8 93.4
Zähler: 12 16 11 1 0 0 0 0 0 0 0
Innenzehner: 10
Weiteste: 903 (2.), 725 (34.), 708 (40.)
beste Teiler: 17.7 (35.), 57.2 (18.), 73.4 (12.)
Trefferkreis: 20.78 mm
Trefferlage: 0.62 mm rechts, 0.20 mm hoch

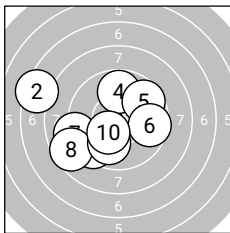
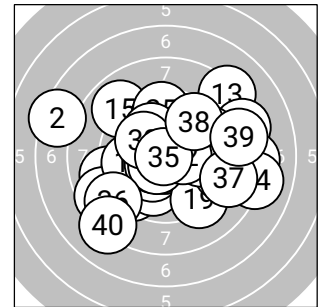

Serie 1: 93.3 (88)

9.8↗ 7.3↖ 9.4↙ 9.8↑ 9.6↗
 9.6↗ 9.0↖ 8.6↙ 9.9↘ 10.3*↙

beste Teiler: 169.6 (10.), 263.5 (9.), 276.3 (1.)
Trefferkreis: 16.84 mm
Trefferlage: 1.42 mm links, 0.26 mm tief

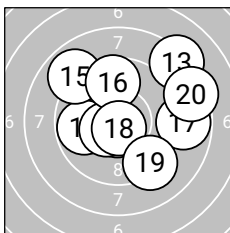

Serie 2: 94.9 (89)

9.8↖ 10.7*↓ 8.2↗ 10.5*↖ 8.9↖
 9.7↑ 8.8→ 10.7*↓ 9.2↘ 8.4↗

beste Teiler: 57.2 (18.), 73.4 (12.), 118.1 (14.)
Trefferkreis: 14.73 mm
Trefferlage: 1.09 mm rechts, 0.80 mm hoch

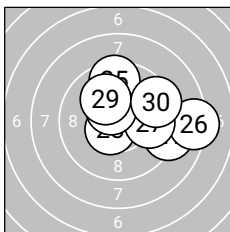

Serie 3: 97.8 (94)

9.1↗ 10.4*↗ 10.5*↙ 10.2*↑ 9.5↑
 8.3↗ 9.8→ 10.5*↖ 10.1↖ 9.4↗

beste Teiler: 102.5 (23.), 119.8 (28.), 150.0 (22.)
Trefferkreis: 12.66 mm
Trefferlage: 1.54 mm rechts, 0.88 mm hoch

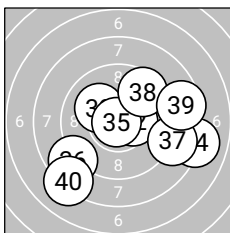

Serie 4: 93.4 (88)

9.9↗ 10.4*→ 10.1↖ 8.1→ 10.9*↖
 8.8↙ 8.9→ 9.6↗ 8.6→ 8.1↙

beste Teiler: 17.7 (35.), 135.0 (32.), 213.6 (33.)
Trefferkreis: 16.93 mm
Trefferlage: 1.29 mm rechts, 0.61 mm tief



Ergebnis: 390.0 (374)
Serien: 97.2 98.2 95.3 99.3
Zähler: 15 24 1 0 0 0 0 0 0 0
Innenzehner: 8
Weiteste: 668 (29.), 466 (12.), 465 (8.)
beste Teiler: 53.8 (39.), 78.7 (19.), 91.2 (36.)
Trefferkreis: 15.24 mm
Trefferlage: 0.09 mm rechts, 0.65 mm hoch

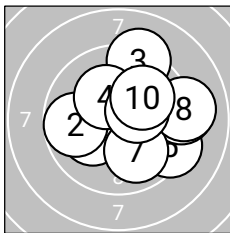
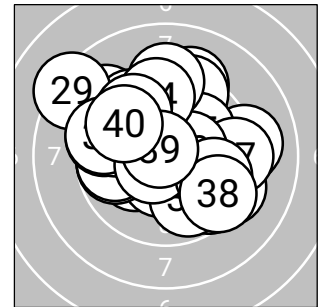

Serie 1: 97.2 (95)

10.1 ←	9.7 ←	9.2 ↑	10.2* ↖	9.3 ↘
9.2 →	10.0 ↘	9.1 →	10.4* →	10.0 ↗

beste Teiler: 146.2 (9.), 181.2 (4.), 202.7 (1.)
Trefferkreis: 12.17 mm
Trefferlage: 1.27 mm rechts, 0.38 mm hoch

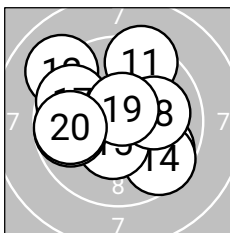

Serie 2: 98.2 (93)

9.4 ↑	9.1 ↖	9.8 ↘	9.6 ↘	10.4* ↓
9.8 ←	9.7 ←	10.0 →	10.6* ↑	9.8 ←

beste Teiler: 78.7 (19.), 135.0 (15.), 226.0 (18.)
Trefferkreis: 12.58 mm
Trefferlage: 0.37 mm links, 0.30 mm hoch

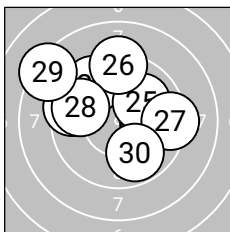

Serie 3: 95.3 (92)

10.0 →	10.0 →	9.4 ←	9.6 ↖	10.0 ↗
9.2 ↑	9.3 →	9.7 ←	8.3 ↖	9.8 ↘

beste Teiler: 233.1 (25.), 239.3 (21.), 250.5 (22.)
Trefferkreis: 14.78 mm
Trefferlage: 0.19 mm links, 1.17 mm hoch

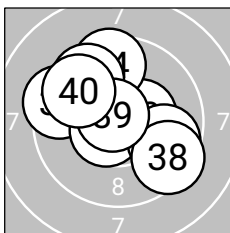

Serie 4: 99.3 (94)

10.2* ↖	9.4 ←	10.4* →	9.5 ↑	9.7 ↖
10.6* ↖	9.7 ↘	9.4 ↘	10.7* ↖	9.7 ↖

beste Teiler: 53.8 (39.), 91.2 (36.), 139.9 (33.)
Trefferkreis: 12.03 mm
Trefferlage: 0.31 mm links, 0.77 mm hoch



Ergebnis: **402.6** (386)
 Serien: 99.9 98.3 102.3 102.1
 Zähler: 26 14 0 0 0 0 0 0 0 0 0
 Innenzehner: 15
 Weitester: 476 (10.), 475 (14.), 437 (13.)
 beste Teiler: 12.6 (38.), 33.5 (23.), 46.0 (9.)
 Trefferkreis: 12.61 mm
 Trefferlage: 0.48 mm links, 0.75 mm hoch

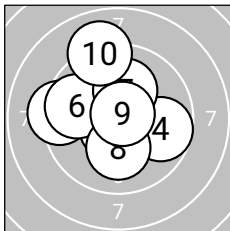
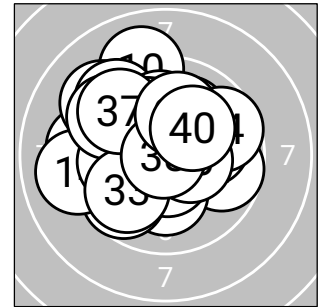

Serie 1: 99.9 (96)
 10.6*↙ 10.1↑ 10.5*↘ 9.7→ 9.3←
 9.7↙ 10.1↑ 10.1↓ 10.8*↗ 9.0↑
 beste Teiler: 46.0 (9.), 78.1 (1.), 117.4 (3.)
 Trefferkreis: 12.00 mm
 Trefferlage: 0.48 mm links, 0.59 mm hoch

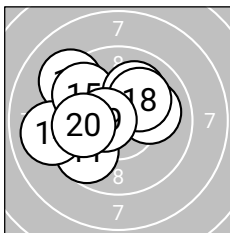

Serie 2: 98.3 (95)
 9.7↙ 9.8↖ 9.2↖ 9.1← 9.7↖
 10.0→ 10.1↗ 10.1↗ 10.6*← 10.0←
 beste Teiler: 95.0 (19.), 210.7 (18.), 225.3 (17.)
 Trefferkreis: 11.53 mm
 Trefferlage: 1.37 mm links, 0.67 mm hoch

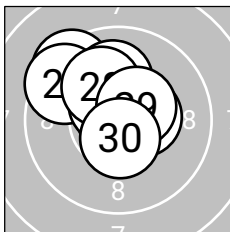

Serie 3: 102.3 (98)
 9.4↖ 10.6*→ 10.8*↖ 9.5↖ 10.5*↖
 10.4*→ 10.0↑ 10.1↖ 10.5*↗ 10.5*↓
 beste Teiler: 33.5 (23.), 87.2 (22.), 102.4 (30.)
 Trefferkreis: 9.31 mm
 Trefferlage: 0.42 mm links, 1.01 mm hoch

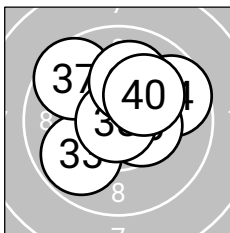

Serie 4: 102.1 (97)
 10.6*↗ 10.4*↗ 9.8↙ 9.7→ 10.5*↑
 10.4*→ 9.6↖ 10.9*← 10.1↑ 10.1↗
 beste Teiler: 12.6 (38.), 81.3 (31.), 118.3 (35.)
 Trefferkreis: 10.66 mm
 Trefferlage: 0.35 mm rechts, 0.74 mm hoch



Ergebnis: **409.7 (394)**
 Serien: 101.2 102.8 102.4 103.3
 Zähler: 34 6 0 0 0 0 0 0 0 0
 Innenzehner: 22
 Weitester: 371 (2.), 349 (4.), 308 (13.)
 beste Teiler: 12.1 (33.), 33.6 (26.), 35.3 (10.)
 Trefferkreis: 10.94 mm
 Trefferlage: 0.18 mm rechts, 0.14 mm hoch

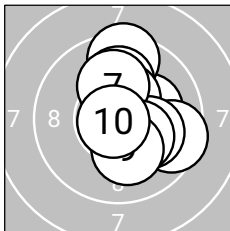
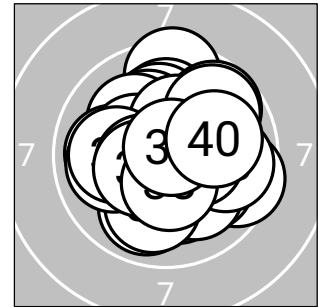

Serie 1: 101.2 (98)

10.2*➔	9.5↑	10.0↑	9.6➔	10.4*↗
10.1➔	10.1↑	10.3*↘	10.2*↓	10.8*↙

beste Teiler: 35.3 (10.), 131.8 (5.), 164.3 (8.)
 Trefferkreis: 10.31 mm
 Trefferlage: 0.88 mm rechts, 0.48 mm hoch

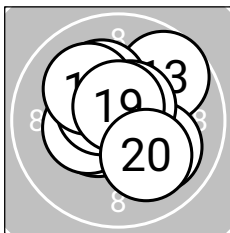

Serie 2: 102.8 (99)

10.5*↙	10.3*↙	9.7↗	10.6*↖	10.2*↖
10.1↖	10.0➔	10.6*↗	10.7*↑	10.1➔

beste Teiler: 69.0 (19.), 90.1 (18.), 97.6 (14.)
 Trefferkreis: 9.13 mm
 Trefferlage: 0.05 mm rechts, 0.35 mm hoch

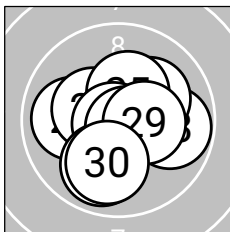

Serie 3: 102.4 (98)

10.0↖	10.4*↖	9.8➔	10.1↗	10.3*↗
10.8*↙	9.9↓	10.7*↘	10.4*➔	10.0↓

beste Teiler: 33.6 (26.), 61.5 (28.), 141.6 (29.)
 Trefferkreis: 9.80 mm
 Trefferlage: 0.12 mm rechts, 0.25 mm tief

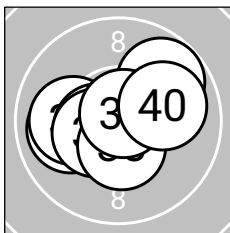

Serie 4: 103.3 (99)

10.5*↙	10.0↖	10.9*↓	10.0↖	10.5*↙
9.8↗	10.4*↙	10.4*↓	10.8*↗	10.0➔

beste Teiler: 12.1 (33.), 45.8 (39.), 111.0 (35.)
 Trefferkreis: 9.66 mm
 Trefferlage: 0.31 mm links, 0.01 mm tief



Ergebnis: 410.3 (393)
Serien: 104.0 102.4 104.0 99.9
Zähler: 33 7 0 0 0 0 0 0 0 0
Innenzehner: 27
Weiteste: 478 (34.), 400 (18.), 385 (35.)
beste Teiler: 3.6 (27.), 43.0 (36.), 50.2 (9.)
Trefferkreis: 13.07 mm
Trefferlage: 0.25 mm rechts, 0.10 mm hoch

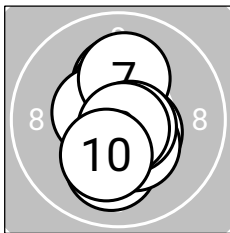
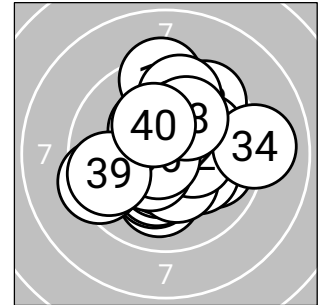

Serie 1: 104.0 (100)

10.2*↑	10.5*↑	10.1↓	10.5*↘	10.5*↙
10.4*↘	10.1↑	10.7*↘	10.8*↘	10.2*↘

beste Teiler: 50.2 (9.), 69.9 (8.), 107.2 (5.)
Trefferkreis: 8.77 mm
Trefferlage: 0.06 mm rechts, 0.11 mm tief

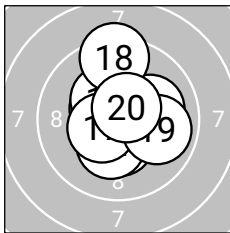

Serie 2: 102.4 (98)

10.5*↙	10.4*↓	10.4*↘	10.3*↘	10.1→
10.3*↙	10.5*↙	9.4↑	9.9→	10.6*↗

beste Teiler: 92.6 (20.), 115.0 (11.), 119.4 (17.)
Trefferkreis: 10.26 mm
Trefferlage: 0.10 mm rechts, 0.19 mm hoch

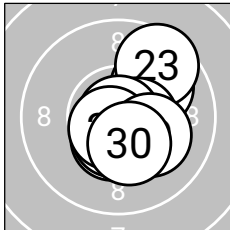

Serie 3: 104.0 (99)

10.0↗	10.7*↘	9.6↗	10.5*↓	10.5*↓
10.6*↘	10.9*↘	10.7*↘	10.2*↘	10.3*↘

beste Teiler: 3.6 (27.), 60.4 (22.), 74.4 (28.)
Trefferkreis: 9.13 mm
Trefferlage: 0.67 mm rechts, 0.10 mm tief

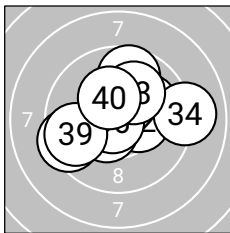

Serie 4: 99.9 (96)

10.0↗	10.4*↘	10.5*↘	9.0→	9.4↙
10.8*↙	9.7↑	10.1↗	9.7↙	10.3*↙

beste Teiler: 43.0 (36.), 115.9 (33.), 146.2 (32.)
Trefferkreis: 13.04 mm
Trefferlage: 0.16 mm rechts, 0.44 mm hoch



Ergebnis: **385.4** (368)
 Serien: 97.5 94.4 97.0 96.5
 Zähler: 12 24 4 0 0 0 0 0 0 0
 Innenezehner: 7
 Weitestе: 600 (35.), 549 (21.), 532 (20.)
 beste Teiler: 54.6 (15.), 55.4 (9.), 121.6 (10.)
 Trefferkreis: 15.54 mm
 Trefferlage: 0.17 mm rechts, 0.20 mm tief

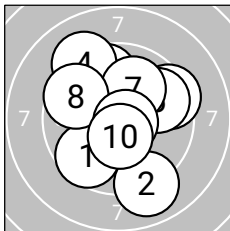
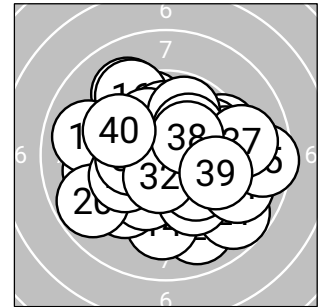

Serie 1: 97.5 (93)
 9.6 ↙ 9.0 ↘ 9.7 ↗ 9.2 ↖ 9.4 ↘
 9.8 ↘ 10.0 ↗ 9.6 ↖ 10.7* ↘ 10.5* ↘
 beste Teiler: 55.4 (9.), 121.6 (10.), 232.5 (7.)
 Trefferkreis: 13.85 mm
 Trefferlage: 0.14 mm rechts, 0.47 mm hoch

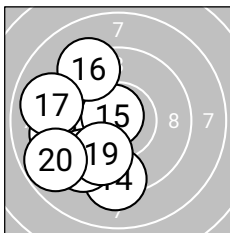

Serie 2: 94.4 (90)
 9.4 ↙ 9.3 ↖ 9.3 ↖ 9.3 ↓ 10.7* ↖
 9.3 ↗ 9.0 ↖ 9.4 ↗ 9.9 ↘ 8.8 ↖
 beste Teiler: 54.6 (15.), 268.3 (19.), 382.6 (18.)
 Trefferkreis: 12.61 mm
 Trefferlage: 2.74 mm links, 1.08 mm tief

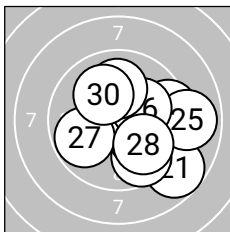

Serie 3: 97.0 (92)
 8.8 ↘ 9.7 ↘ 10.2* ↘ 9.4 → 8.9 →
 10.2* ↗ 9.8 ↖ 9.9 ↘ 10.0 ↑ 10.1 ↖
 beste Teiler: 192.5 (23.), 195.0 (26.), 220.0 (30.)
 Trefferkreis: 12.27 mm
 Trefferlage: 1.61 mm rechts, 0.46 mm tief

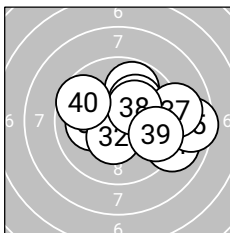

Serie 4: 96.5 (93)
 10.1 ↖ 10.4* ↘ 9.8 ↗ 9.0 ↘ 8.6 →
 10.1 ↗ 9.0 → 10.3* ↗ 9.6 ↘ 9.6 ↖
 beste Teiler: 138.6 (32.), 171.3 (38.), 210.2 (36.)
 Trefferkreis: 13.58 mm
 Trefferlage: 1.67 mm rechts, 0.27 mm hoch



LG 40 ZR

StandNr: 115

Entner, Lorena #70818370

Jungschützinnen

Wertung

StartNr: 63

08.03.2026 11:25

SG_Breitenbach

Ergebnis: **406.1** (388)
 Serien: 104.1 99.3 100.1 102.6
 Zähler: 31 6 3 0 0 0 0 0 0 0
 Innenzehner: 23
 Weitester: 591 (22.), 582 (12.), 514 (23.)
 beste Teiler: 30.0 (33.), 51.0 (26.), 74.1 (3.)
 Trefferkreis: 16.21 mm
 Trefferlage: 0.06 mm links, 0.74 mm hoch

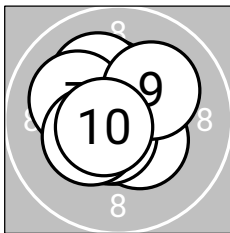
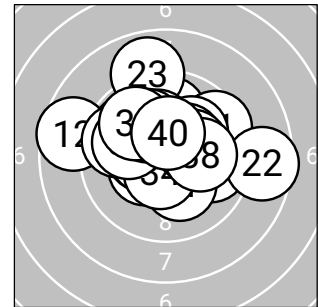

Serie 1: 104.1 (100)

10.6*↖	10.3*↖	10.7*↘	10.4*↗	10.2*↖
10.6*↙	10.1↖	10.4*↖	10.1↗	10.7*↖
beste Teiler: 74.1 (3.), 74.2 (10.), 85.4 (6.)				
Trefferkreis: 8.15 mm				
Trefferlage: 0.36 mm links, 0.28 mm hoch				

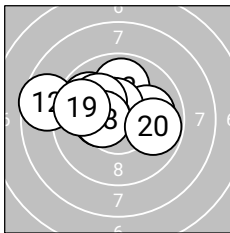

Serie 2: 99.3 (94)

9.9↖	8.6↖	9.9↑	10.4*↖	10.0→
10.5*↖	10.1↖	10.4*↖	9.7↖	9.8→
beste Teiler: 108.1 (16.), 127.0 (18.), 137.1 (14.)				
Trefferkreis: 13.16 mm				
Trefferlage: 1.00 mm links, 0.88 mm hoch				

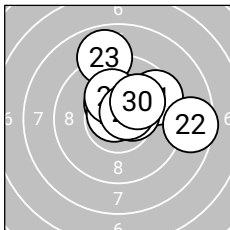

Serie 3: 100.1 (95)

9.6↗	8.6→	8.9↑	10.4*↖	10.5*↗
10.7*↖	10.2*↖	10.5*↗	10.6*↗	10.1↗
beste Teiler: 51.0 (26.), 90.4 (29.), 123.3 (28.)				
Trefferkreis: 13.41 mm				
Trefferlage: 1.08 mm rechts, 1.29 mm hoch				

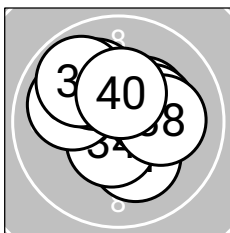

Serie 4: 102.6 (99)

10.2*↘	10.3*↗	10.8*↖	10.5*↘	10.0↖
10.1↖	10.3*↗	10.1→	9.9↖	10.4*↖
beste Teiler: 30.0 (33.), 105.3 (34.), 141.6 (40.)				
Trefferkreis: 9.15 mm				
Trefferlage: 0.02 mm rechts, 0.53 mm hoch				



Ergebnis: 392.9 (372)
Serien: 94.6 99.1 99.7 99.5
Zähler: 19 16 3 2 0 0 0 0 0 0
Innenzehner: 12
Weiteste: 803 (8.), 799 (5.), 611 (4.)
beste Teiler: 47.1 (13.), 73.1 (26.), 84.6 (35.)
Trefferkreis: 18.15 mm
Trefferlage: 0.27 mm links, 0.30 mm hoch

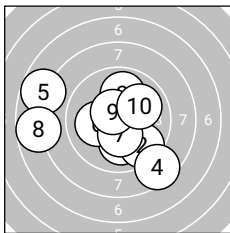
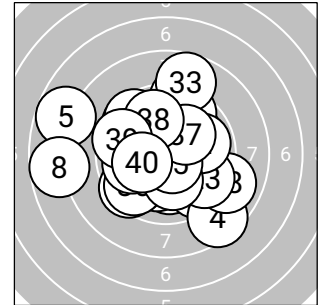

Serie 1: 94.6 (90)

10.0↓	9.6↘	9.9↑	8.5↘	7.8↖
10.1↖	10.4*↓	7.7↖	10.6*↖	10.0↗

beste Teiler: 94.0 (9.), 146.1 (7.), 212.0 (6.)
Trefferkreis: 18.14 mm
Trefferlage: 0.88 mm links, 0.49 mm tief

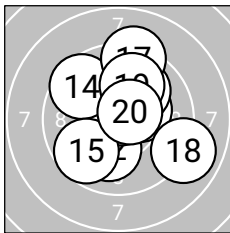

Serie 2: 99.1 (94)

10.3*↗	10.1↓	10.8*↑	9.6↖	9.7↗
10.0↗	9.2↑	8.9↘	9.9↑	10.6*↗

beste Teiler: 47.1 (13.), 94.8 (20.), 161.5 (11.)
Trefferkreis: 12.84 mm
Trefferlage: 0.49 mm rechts, 0.60 mm hoch

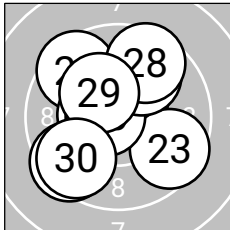

Serie 3: 99.7 (94)

9.5↖	10.5*↗	9.6↘	10.5*↖	9.5↖
10.7*↖	9.9↑	9.6↑	10.3*↖	9.6↖

beste Teiler: 73.1 (26.), 116.4 (22.), 120.7 (24.)
Trefferkreis: 11.61 mm
Trefferlage: 0.41 mm links, 0.38 mm hoch

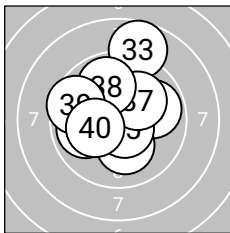

Serie 4: 99.5 (94)

9.9↗	10.5*↖	8.7↑	10.1↓	10.6*↘
9.9↖	10.1↗	9.9↖	9.6↖	10.2*↖

beste Teiler: 84.6 (35.), 112.4 (32.), 188.8 (40.)
Trefferkreis: 12.02 mm
Trefferlage: 0.29 mm links, 0.72 mm hoch



