

LG 40 ZR

StandNr: 119

Scheffler, Maik #70819191

Senioren_1m

Wertung

StartNr: 19

01.03.2026 09:54

SG_Imst

SG Imst 3

Ergebnis: **416.9** (397)
 Serien: 104.1 102.8 104.3 105.7
 Zähler: 37 3 0 0 0 0 0 0 0 0
 Innenzehner: 33
 Weitest: 388 (17.), 301 (5.), 275 (29.)
 beste Teiler: 31.0 (2.), 39.3 (16.), 40.3 (31.)
 Trefferkreis: 10.26 mm
 Trefferlage: 0.14 mm rechts, 0.23 mm tief

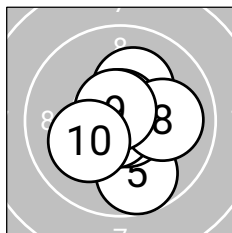
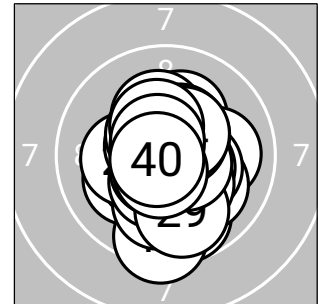
**Serie 1: 104.1** (99)

10.4*➔ 10.8*↓ 10.2*↗ 10.7*↑ 9.7↓
 10.8*↘ 10.7*↙ 10.0➔ 10.7*↖ 10.1↙

beste Teiler: 31.0 (2.), 45.4 (6.), 51.6 (7.)
 Trefferkreis: 9.20 mm
 Trefferlage: 0.32 mm rechts, 0.14 mm tief

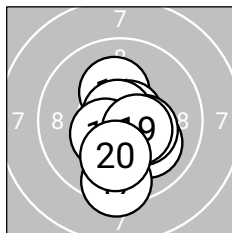
**Serie 2: 102.8** (99)

10.2*↑ 10.7*↗ 10.1↘ 10.4*↙ 10.3*➔
 10.8*↖ 9.4↓ 10.4*↙ 10.5*➔ 10.0↓

beste Teiler: 39.3 (16.), 57.1 (12.), 122.1 (19.)
 Trefferkreis: 10.19 mm
 Trefferlage: 0.20 mm rechts, 0.82 mm tief

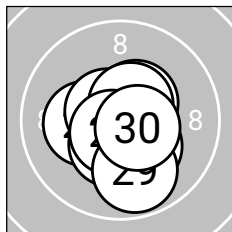
**Serie 3: 104.3** (99)

10.2*← 10.3*↘ 10.4*↙ 10.5*↗ 10.6*↖
 10.6*↘ 10.6*↗ 10.6*↙ 9.9↓ 10.6*➔

beste Teiler: 78.7 (28.), 83.4 (25.), 89.8 (26.)
 Trefferkreis: 8.40 mm
 Trefferlage: 0.13 mm rechts, 0.48 mm tief

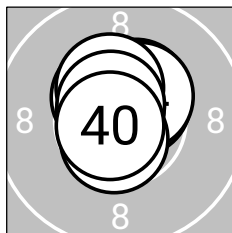
**Serie 4: 105.7** (100)

10.8*← 10.5*↗ 10.4*↗ 10.4*↗ 10.5*↖
 10.6*↓ 10.4*↖ 10.7*↖ 10.6*↖ 10.8*↖

beste Teiler: 40.3 (31.), 47.8 (40.), 54.2 (38.)
 Trefferkreis: 6.72 mm
 Trefferlage: 0.08 mm links, 0.53 mm hoch

Ergebnis: **418.9** (397)
 Serien: 102.6 105.3 105.8 105.2
 Zähler: 37 3 0 0 0 0 0 0 0 0
 Innenzehner: 35
 Weitester: 331 (1.), 301 (3.), 274 (5.)
 beste Teiler: 46.0 (24.), 52.6 (26.), 62.0 (32.)
 Trefferkreis: 10.74 mm
 Trefferlage: 0.08 mm links, 0.14 mm tief

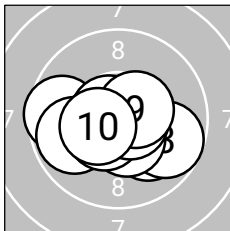
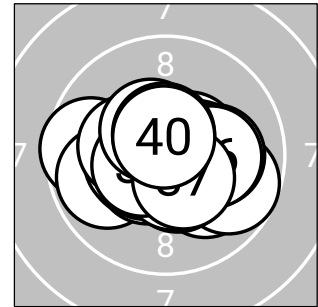

Serie 1: 102.6 (97)

9.6←	10.1↘	9.7↘	10.5*↓	9.9←
10.5*↙	10.7*↙	10.7*→	10.5*→	10.4*←

beste Teiler: 63.5 (7.), 71.1 (8.), 112.4 (6.)
 Trefferkreis: 10.74 mm
 Trefferlage: 0.17 mm links, 0.49 mm tief

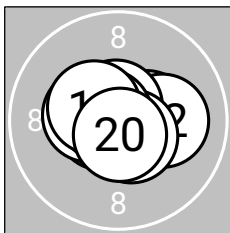

Serie 2: 105.3 (100)

10.4*→	10.1→	10.7*↑	10.6*←	10.7*←
10.4*←	10.6*↘	10.7*←	10.4*←	10.7*↓

beste Teiler: 66.4 (18.), 68.0 (13.), 69.0 (15.)
 Trefferkreis: 8.03 mm
 Trefferlage: 0.06 mm links, 0.03 mm hoch

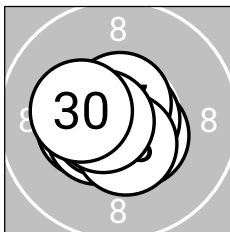

Serie 3: 105.8 (100)

10.4*←	10.5*↙	10.5*↘	10.8*→	10.7*←
10.7*↙	10.7*↑	10.5*↓	10.7*←	10.3*←

beste Teiler: 46.0 (24.), 52.6 (26.), 67.2 (29.)
 Trefferkreis: 7.21 mm
 Trefferlage: 0.39 mm links, 0.13 mm tief

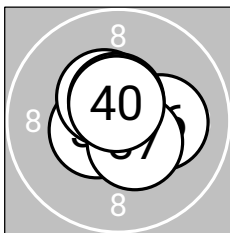

Serie 4: 105.2 (100)

10.6*→	10.7*←	10.5*←	10.6*↘	10.6*→
10.2*→	10.4*↘	10.4*↙	10.6*↑	10.6*↑

beste Teiler: 62.0 (32.), 80.5 (40.), 88.3 (31.)
 Trefferkreis: 7.57 mm
 Trefferlage: 0.28 mm rechts, 0.03 mm hoch



LG 40 ZR

StandNr: 121

Lanthaler, Manfred #70819193

Senioren_1m

Wertung

StartNr: 21

01.03.2026 09:49

SG_Zell_am_Ziller

SG Zell am Ziller 1

Ergebnis: **421.9** (400)
 Serien: 105.5 106.2 104.7 105.5
 Zähler: 40 0 0 0 0 0 0 0 0 0 0
 Innenzehner: 37
 Weitester: 239 (39.), 209 (22.), 206 (8.)
 beste Teiler: 10.4 (29.), 33.2 (34.), 38.4 (19.)
 Trefferkreis: 8.75 mm
 Trefferlage: 0.06 mm links, 0.07 mm tief

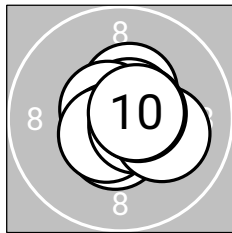
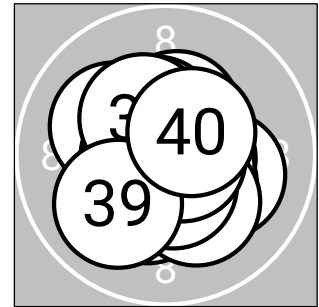
**Serie 1: 105.5** (100)

10.4*↗	10.7*↗	10.7*↖	10.7*↖	10.5*↓
10.6*↙	10.6*↘	10.1↘	10.6*↘	10.6*↘

beste Teiler: 68.5 (4.), 70.2 (2.), 74.2 (3.)
 Trefferkreis: 7.35 mm
 Trefferlage: 0.32 mm rechts, 0.04 mm tief

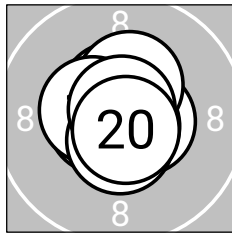
**Serie 2: 106.2** (100)

10.6*←	10.6*→	10.6*↑	10.6*←	10.8*↘
10.4*↗	10.5*←	10.6*↓	10.8*↑	10.7*↘

beste Teiler: 38.4 (19.), 40.6 (15.), 53.2 (20.)
 Trefferkreis: 6.89 mm
 Trefferlage: 0.11 mm links, 0.13 mm hoch

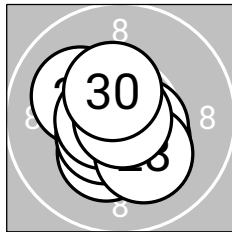
**Serie 3: 104.7** (100)

10.4*↘	10.1↖	10.6*↙	10.6*↘	10.3*↙
10.5*↙	10.7*←	10.2*↘	10.9*↘	10.4*↑

beste Teiler: 10.4 (29.), 75.3 (27.), 82.0 (23.)
 Trefferkreis: 8.42 mm
 Trefferlage: 0.18 mm links, 0.37 mm tief

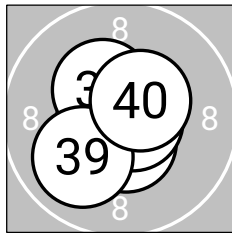
**Serie 4: 105.5** (100)

10.5*↖	10.7*↖	10.8*↙	10.8*↑	10.5*↓
10.7*←	10.7*→	10.3*↖	10.0↙	10.5*↗

beste Teiler: 33.2 (34.), 49.5 (33.), 51.7 (36.)
 Trefferkreis: 8.11 mm
 Trefferlage: 0.27 mm links, 0.00 mm

Ergebnis: **414.4 (391)**
 Serien: 104.1 106.0 97.7 106.6
 Zähler: 38 1 0 0 0 0 0 0 1 0 0
 Innenzehner: 37
 Weitester: 2040 (21.), 433 (4.), 205 (27.)
 beste Teiler: 7.2 (19.), 8.0 (28.), 30.5 (32.)
 Trefferkreis: 26.24 mm
 Trefferlage: 0.03 mm rechts, 0.72 mm tief

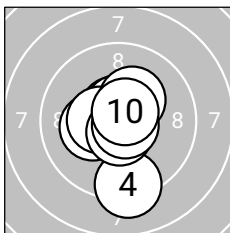
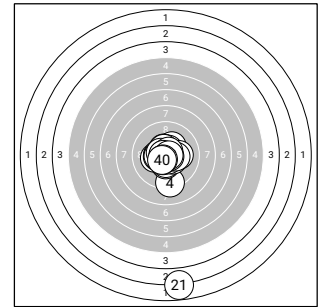

Serie 1: 104.1 (99)

10.6*↖	10.6*↑	10.8*↓	9.2↓	10.2*↙
10.5*↙	10.6*↓	10.3*↗	10.7*↘	10.6*↗

beste Teiler: 46.0 (3.), 54.7 (9.), 76.4 (10.)
 Trefferkreis: 10.20 mm
 Trefferlage: 0.06 mm links, 0.25 mm tief

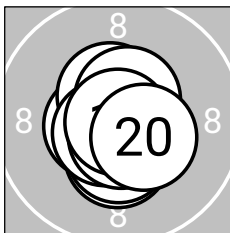

Serie 2: 106.0 (100)

10.6*↙	10.7*↙	10.4*↓	10.5*↑	10.5*↓
10.7*↙	10.7*↓	10.6*↗	10.9*↓	10.4*↘

beste Teiler: 7.2 (19.), 64.1 (17.), 65.2 (12.)
 Trefferkreis: 7.03 mm
 Trefferlage: 0.06 mm links, 0.34 mm tief

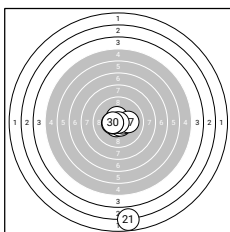

Serie 3: 97.7 (92)

2.8↓	10.6*↙	10.7*↘	10.6*↘	10.5*↑
10.6*↘	10.1→	10.9*↓	10.4*↙	10.5*↙

beste Teiler: 8.0 (28.), 57.2 (23.), 79.6 (24.)
 Trefferkreis: 25.93 mm
 Trefferlage: 0.27 mm rechts, 2.17 mm tief

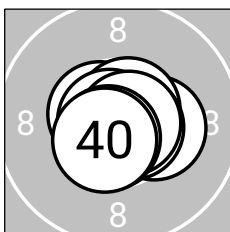

Serie 4: 106.6 (100)

10.6*↙	10.8*↙	10.7*↙	10.3*↘	10.7*↗
10.8*↙	10.7*↘	10.8*↘	10.6*↙	10.6*↙

beste Teiler: 30.5 (32.), 38.4 (36.), 45.0 (38.)
 Trefferkreis: 6.92 mm
 Trefferlage: 0.01 mm rechts, 0.14 mm tief



Ergebnis: **418.6** (400)
 Serien: 104.1 104.6 104.7 105.2
 Zähler: 40 0 0 0 0 0 0 0 0 0 0
 Innenzehner: 34
 Weitester: 232 (7.), 218 (17.), 211 (16.)
 beste Teiler: 23.2 (6.), 40.0 (9.), 50.0 (18.)
 Trefferkreis: 8.92 mm
 Trefferlage: 0.00 mm , 0.01 mm tief

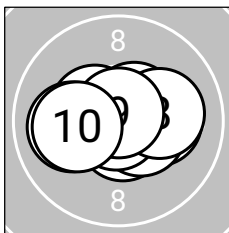
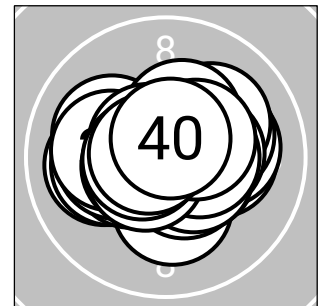

Serie 1: 104.1 (100)

10.4*↖ 10.5*↗ 10.2*↔ 10.6*↓ 10.5*↘
 10.9*↙ 10.0← 10.1→ 10.8*↑ 10.1←

beste Teiler: 23.2 (6.), 40.0 (9.), 78.4 (4.)
 Trefferkreis: 8.92 mm
 Trefferlage: 0.05 mm rechts, 0.00 mm

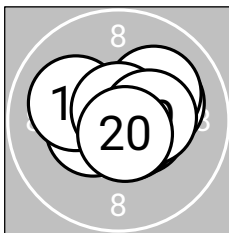

Serie 2: 104.6 (100)

10.7*↖ 10.5*↗ 10.5*↖ 10.6*↘ 10.2*↗
 10.1↗ 10.1← 10.8*↑ 10.4*↔ 10.7*↘

beste Teiler: 50.0 (18.), 64.6 (11.), 71.5 (20.)
 Trefferkreis: 8.35 mm
 Trefferlage: 0.29 mm rechts, 0.16 mm hoch

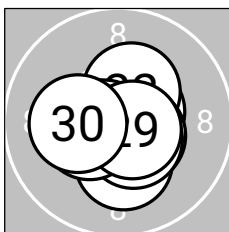

Serie 3: 104.7 (100)

10.6*↗ 10.3*↗ 10.6*↖ 10.7*↖ 10.2*↓
 10.5*↘ 10.5*↘ 10.4*↖ 10.7*↗ 10.2*←

beste Teiler: 71.1 (24.), 74.3 (29.), 94.1 (21.)
 Trefferkreis: 7.91 mm
 Trefferlage: 0.08 mm links, 0.27 mm tief

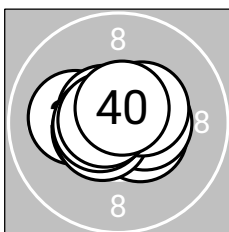

Serie 4: 105.2 (100)

10.1← 10.6*↖ 10.5*↘ 10.6*↖ 10.4*↔
 10.6*↖ 10.6*← 10.4*↗ 10.7*↖ 10.7*↑

beste Teiler: 65.3 (39.), 72.2 (40.), 82.8 (32.)
 Trefferkreis: 7.84 mm
 Trefferlage: 0.23 mm links, 0.07 mm hoch

Ergebnis: **400.2** (382)
 Serien: 100.6 98.8 98.6 102.2
 Zähler: 24 14 2 0 0 0 0 0 0 0
 Innenzehner: 16
 Weitestе: 655 (11.), 592 (16.), 462 (22.)
 beste Teiler: 36.7 (8.), 41.3 (36.), 60.0 (12.)
 Trefferkreis: 16.98 mm
 Trefferlage: 0.35 mm rechts, 0.20 mm tief

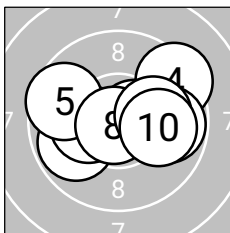
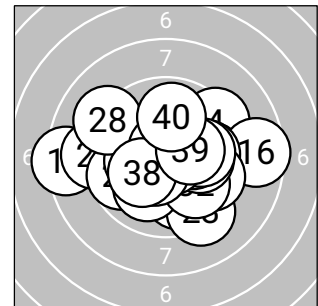

Serie 1: 100.6 (96)

10.1→	9.9←	10.3*←	9.4↗	9.6←
10.6*→	9.8→	10.8*↖	10.1→	10.0→

beste Teiler: 36.7 (8.), 95.0 (6.), 175.1 (3.)
 Trefferkreis: 11.25 mm
 Trefferlage: 0.58 mm rechts, 0.16 mm hoch

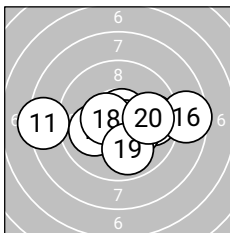

Serie 2: 98.8 (93)

8.3←	10.7*↗	9.8→	10.7*↘	10.1←
8.6→	10.3*↘	10.5*←	9.9↘	9.9→

beste Teiler: 60.0 (12.), 74.8 (14.), 106.0 (18.)
 Trefferkreis: 16.98 mm
 Trefferlage: 0.49 mm rechts, 0.37 mm tief

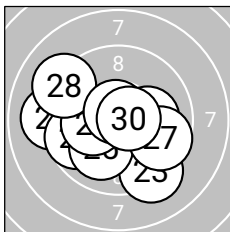

Serie 3: 98.6 (95)

10.1→	9.1←	9.3↘	9.7←	10.0↖
10.2*←	9.7↗	9.1←	10.7*↖	10.7*→

beste Teiler: 61.0 (29.), 73.8 (30.), 180.4 (26.)
 Trefferkreis: 13.04 mm
 Trefferlage: 0.65 mm links, 0.48 mm tief

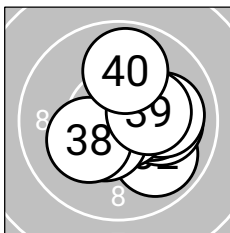

Serie 4: 102.2 (98)

10.2*↘	9.9↘	10.1→	10.3*→	10.0→
10.8*↘	10.5*↖	10.2*←	10.3*→	9.9↑

beste Teiler: 41.3 (36.), 117.0 (37.), 167.4 (39.)
 Trefferkreis: 9.34 mm
 Trefferlage: 1.01 mm rechts, 0.12 mm tief



Ergebnis: **415.5** (397)
 Serien: 102.9 104.0 105.2 103.4
 Zähler: 37 3 0 0 0 0 0 0 0 0
 Innenzehner: 30
 Weitester: 408 (2.), 286 (39.), 251 (6.)
 beste Teiler: 25.0 (28.), 29.2 (31.), 47.0 (8.)
 Trefferkreis: 10.87 mm
 Trefferlage: 0.39 mm rechts, 0.41 mm hoch

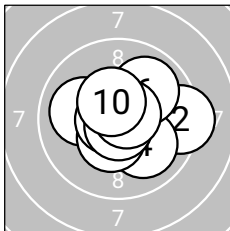
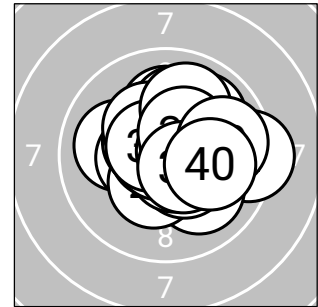

Serie 1: 102.9 (98)

10.0 ←	9.3 →	10.6* ↗	10.0 ↘	10.4* ↘
9.9 ↗	10.7* ←	10.8* ↓	10.7* ↗	10.5* ↖

beste Teiler: 47.0 (8.), 59.3 (7.), 63.1 (9.)
 Trefferkreis: 10.87 mm
 Trefferlage: 0.49 mm rechts, 0.07 mm hoch

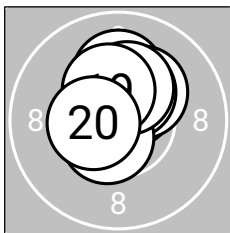

Serie 2: 104.0 (100)

10.1 ↑	10.5* ↑	10.5* ↗	10.6* ←	10.2* ↗
10.4* ↗	10.6* ↘	10.3* ↑	10.3* ↖	10.5* ←

beste Teiler: 90.7 (14.), 96.7 (17.), 105.0 (12.)
 Trefferkreis: 7.49 mm
 Trefferlage: 0.05 mm links, 0.88 mm hoch

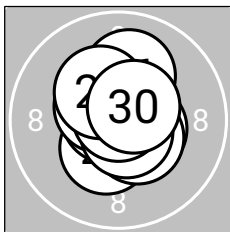

Serie 3: 105.2 (100)

10.4* ↘	10.7* ←	10.5* ↘	10.5* ↘	10.5* ↖
10.1 ↑	10.7* ↘	10.9* ↑	10.3* ↖	10.6* ↗

beste Teiler: 25.0 (28.), 52.4 (22.), 68.0 (27.)
 Trefferkreis: 8.15 mm
 Trefferlage: 0.08 mm rechts, 0.20 mm hoch

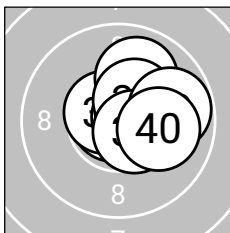

Serie 4: 103.4 (99)

10.8* ←	10.1 →	10.6* ↖	10.6* →	10.5* ↗
10.0 ↗	10.4* ↗	10.5* ↘	9.8 →	10.1 →

beste Teiler: 29.2 (31.), 82.4 (34.), 83.7 (33.)
 Trefferkreis: 7.99 mm
 Trefferlage: 1.05 mm rechts, 0.47 mm hoch



Ergebnis: **407.4** (392)
 Serien: 102.9 102.2 99.9 102.4
 Zähler: 32 8 0 0 0 0 0 0 0 0
 Innenzehner: 27
 Weitestе: 485 (9.), 481 (24.), 462 (21.)
 beste Teiler: 61.7 (22.), 65.2 (5.), 72.2 (6.)
 Trefferkreis: 12.94 mm
 Trefferlage: 0.39 mm links, 0.67 mm hoch

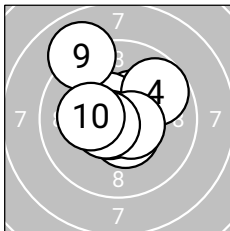
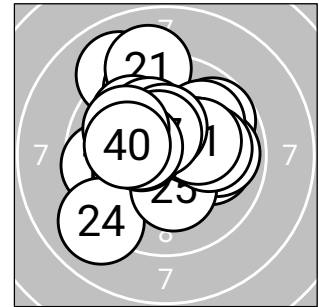

Serie 1: 102.9 (98)

10.5*↘	10.4*↗	10.5*↖	9.7↗	10.7*↙
10.7*↙	10.6*↘	10.6*↖	9.0↖	10.2*↖

beste Teiler: 65.2 (5.), 72.2 (6.), 89.8 (8.)
 Trefferkreis: 10.54 mm
 Trefferlage: 0.22 mm links, 0.53 mm hoch

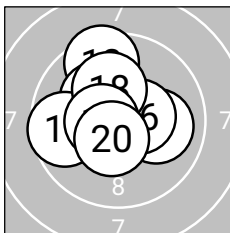

Serie 2: 102.2 (98)

10.0→	9.5↑	10.6*↖	10.5*↖	10.2*↖
10.5*→	9.6←	10.2*↑	10.6*←	10.5*↘

beste Teiler: 93.0 (13.), 100.1 (19.), 114.1 (14.)
 Trefferkreis: 10.37 mm
 Trefferlage: 0.51 mm links, 0.65 mm hoch

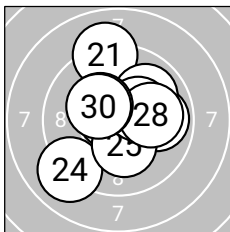

Serie 3: 99.9 (97)

9.1↑	10.7*↖	9.9→	9.0↙	10.3*↓
10.0↗	10.3*↗	10.0→	10.3*↖	10.3*↖

beste Teiler: 61.7 (22.), 158.0 (27.), 161.9 (29.)
 Trefferkreis: 12.93 mm
 Trefferlage: 0.11 mm rechts, 0.45 mm hoch

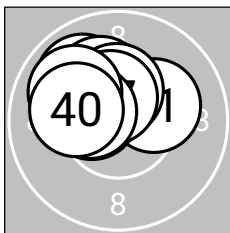

Serie 4: 102.4 (99)

10.2*↗	9.9↖	10.3*↖	10.2*↖	10.4*↑
10.4*↖	10.5*↑	10.4*↖	10.0↖	10.1↖

beste Teiler: 117.9 (37.), 132.8 (36.), 143.8 (38.)
 Trefferkreis: 8.33 mm
 Trefferlage: 0.93 mm links, 1.05 mm hoch



Ergebnis: **421.2** (399)
 Serien: 106.0 105.4 104.6 105.2
 Zähler: 39 1 0 0 0 0 0 0 0 0
 Innenzehner: 38
 Weitester: 270 (29.), 234 (38.), 195 (22.)
 beste Teiler: 36.4 (34.), 45.5 (4.), 47.7 (12.)
 Trefferkreis: 9.06 mm
 Trefferlage: 0.10 mm rechts, 0.03 mm hoch

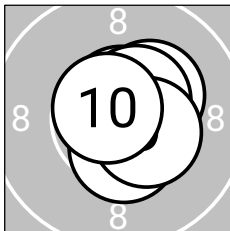
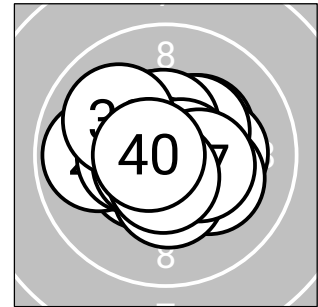

Serie 1: 106.0 (100)

10.3*↗ 10.7*↘ 10.7*↗ 10.8*↘ 10.7*↗
 10.7*↗ 10.5*↘ 10.5*↗ 10.4*↘ 10.7*↘

beste Teiler: 45.5 (4.), 57.0 (5.), 59.6 (2.)
 Trefferkreis: 6.91 mm
 Trefferlage: 0.48 mm rechts, 0.11 mm hoch

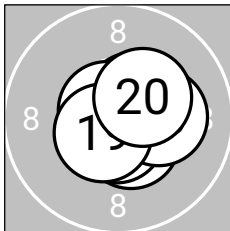

Serie 2: 105.4 (100)

10.4*↗ 10.8*↗ 10.5*↘ 10.7*↘ 10.5*↗
 10.6*↗ 10.7*↘ 10.2*↗ 10.6*↘ 10.4*↗

beste Teiler: 47.7 (12.), 63.0 (17.), 71.5 (14.)
 Trefferkreis: 7.16 mm
 Trefferlage: 0.51 mm rechts, 0.15 mm hoch

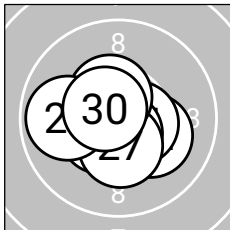

Serie 3: 104.6 (99)

10.7*↖ 10.2*↘ 10.5*↖ 10.6*↘ 10.6*↗
 10.6*↘ 10.4*↘ 10.5*↖ 9.9↖ 10.6*↘

beste Teiler: 63.9 (21.), 77.0 (24.), 83.7 (26.)
 Trefferkreis: 9.01 mm
 Trefferlage: 0.21 mm links, 0.30 mm tief

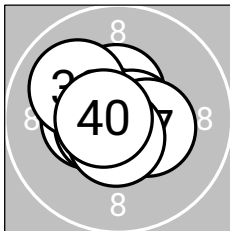

Serie 4: 105.2 (100)

10.4*↖ 10.5*↖ 10.5*↗ 10.8*↖ 10.6*↖
 10.7*↗ 10.4*↘ 10.0↖ 10.6*↘ 10.7*↖

beste Teiler: 36.4 (34.), 60.0 (36.), 68.0 (40.)
 Trefferkreis: 8.19 mm
 Trefferlage: 0.38 mm links, 0.19 mm hoch

LG 40 ZR

StandNr: 128

Maier, Hannes #70819199

Senioren_1m

Wertung

StartNr: 28

01.03.2026 10:03

SG_Sölden

SG Sölden 1

Ergebnis: **418.9** (397)
 Serien: 104.0 104.4 105.2 105.3
 Zähler: 37 3 0 0 0 0 0 0 0 0
 Innenzehner: 34
 Weitester: 291 (4.), 276 (14.), 270 (6.)
 beste Teiler: 35.4 (8.), 36.6 (1.), 39.4 (36.)
 Trefferkreis: 9.71 mm
 Trefferlage: 0.14 mm rechts, 0.24 mm tief

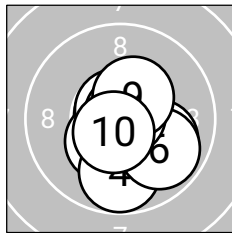
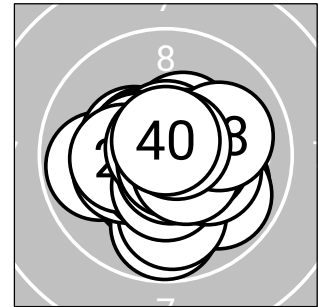
**Serie 1: 104.0** (98)

10.8*↖	10.4*↙	10.6*↘	9.8↓	10.0↘
9.9↘	10.7*↖	10.8*↗	10.4*↗	10.6*↙

beste Teiler: 35.4 (8.), 36.6 (1.), 56.3 (7.)
 Trefferkreis: 8.67 mm
 Trefferlage: 0.42 mm rechts, 0.60 mm tief

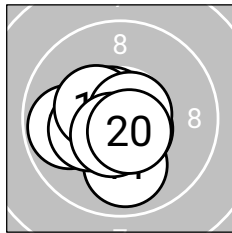
**Serie 2: 104.4** (99)

10.0↓	10.6*↘	10.7*↙	9.8↖	10.7*↖
10.3*↖	10.4*↖	10.7*↗	10.6*↙	10.6*↘

beste Teiler: 55.4 (13.), 57.2 (18.), 74.9 (15.)
 Trefferkreis: 8.30 mm
 Trefferlage: 0.50 mm links, 0.47 mm tief

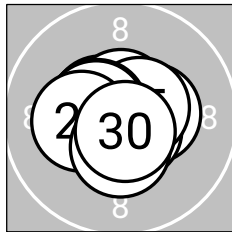
**Serie 3: 105.2** (100)

10.4*→	10.7*↘	10.5*↖	10.6*↑	10.6*↗
10.5*↖	10.5*↖	10.3*←	10.4*↓	10.7*↘

beste Teiler: 63.9 (30.), 74.2 (22.), 84.0 (24.)
 Trefferkreis: 7.63 mm
 Trefferlage: 0.17 mm links, 0.02 mm hoch

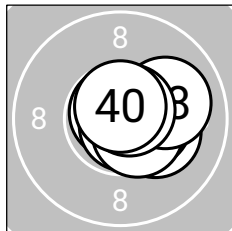
**Serie 4: 105.3** (100)

10.6*→	10.2*↘	10.8*↖	10.5*→	10.5*→
10.8*↘	10.5*↘	10.0→	10.7*↗	10.7*↑

beste Teiler: 39.4 (36.), 40.4 (33.), 60.0 (40.)
 Trefferkreis: 7.03 mm
 Trefferlage: 0.84 mm rechts, 0.06 mm hoch

Ergebnis: **422.7** (400)
 Serien: 106.2 106.0 105.6 104.9
 Zähler: 40 0 0 0 0 0 0 0 0 0 0
 Innenzehner: 37
 Weitester: 244 (30.), 225 (33.), 212 (16.)
 beste Teiler: 16.4 (23.), 25.0 (2.), 37.9 (15.)
 Trefferkreis: 8.73 mm
 Trefferlage: 0.08 mm rechts, 0.06 mm hoch

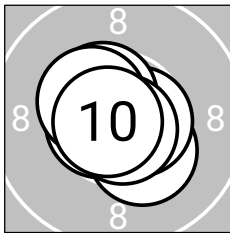
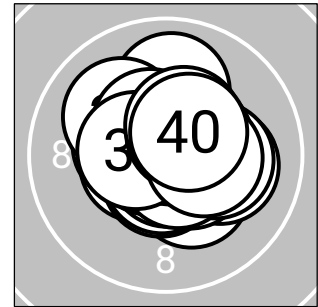

Serie 1: 106.2 (100)

10.6*↘	10.9*↙	10.6*↘	10.7*↖	10.3*↘
10.6*→	10.5*↖	10.8*↘	10.4*↖	10.8*↖

beste Teiler: 25.0 (2.), 45.6 (10.), 46.6 (8.)
 Trefferkreis: 7.40 mm
 Trefferlage: 0.02 mm rechts, 0.16 mm tief

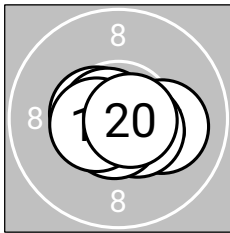

Serie 2: 106.0 (100)

10.5*↖	10.7*↖	10.8*↘	10.7*↘	10.8*↘
10.1→	10.5*↘	10.7*↘	10.5*↖	10.7*→

beste Teiler: 37.9 (15.), 46.0 (13.), 55.6 (12.)
 Trefferkreis: 7.71 mm
 Trefferlage: 0.15 mm rechts, 0.24 mm tief

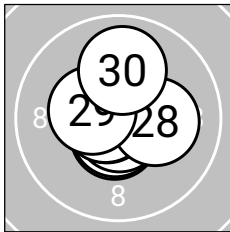

Serie 3: 105.6 (100)

10.6*↓	10.6*↓	10.9*↖	10.8*↓	10.7*↗
10.7*↖	10.7*↖	10.2*→	10.4*↖	10.0↑

beste Teiler: 16.4 (23.), 50.3 (24.), 58.1 (26.)
 Trefferkreis: 7.99 mm
 Trefferlage: 0.04 mm links, 0.07 mm hoch

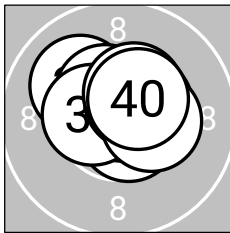

Serie 4: 104.9 (100)

10.7*↘	10.8*↗	10.1↖	10.5*↖	10.5*↗
10.5*↖	10.5*↗	10.4*↗	10.4*→	10.5*↗

beste Teiler: 38.6 (32.), 71.7 (31.), 113.5 (37.)
 Trefferkreis: 8.04 mm
 Trefferlage: 0.20 mm rechts, 0.58 mm hoch



LG 40 ZR

StandNr: 130

Bachnetzer, Martin #70819201

Senioren_1m

Wertung

StartNr: 30

01.03.2026 09:51

SG_Mieming

SG Mieming 1

Ergebnis: **420.0** (398)
 Serien: 104.6 104.7 104.3 106.4
 Zähler: 38 2 0 0 0 0 0 0 0 0
 Innenzehner: 36
 Weitester: 340 (2.), 274 (32.), 236 (17.)
 beste Teiler: 3.6 (6.), 8.2 (31.), 37.3 (35.)
 Trefferkreis: 10.58 mm
 Trefferlage: 0.06 mm links, 0.15 mm hoch

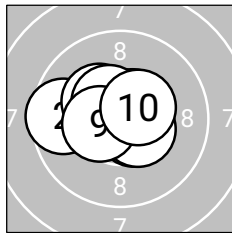
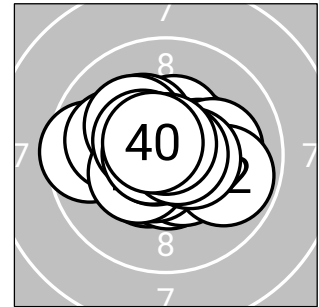
**Serie 1: 104.6** (99)

10.5*↗	9.6←	10.6*↘	10.3*↖	10.7*↑
10.9*↘	10.5*↘	10.5*↖	10.5*←	10.5*↗

beste Teiler: 3.6 (6.), 71.7 (5.), 100.8 (3.)
 Trefferkreis: 9.05 mm
 Trefferlage: 0.27 mm links, 0.27 mm hoch

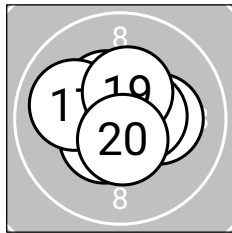
**Serie 2: 104.7** (100)

10.7*↘	10.7*↑	10.5*↙	10.4*↖	10.2*→
10.8*↓	10.0←	10.5*→	10.4*↑	10.5*↓

beste Teiler: 50.2 (16.), 58.2 (12.), 75.0 (11.)
 Trefferkreis: 8.70 mm
 Trefferlage: 0.04 mm rechts, 0.07 mm hoch

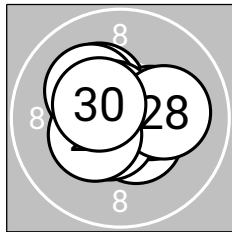
**Serie 3: 104.3** (100)

10.6*↖	10.3*↖	10.5*↘	10.2*↖	10.4*→
10.7*↖	10.6*↙	10.1→	10.4*↖	10.5*↖

beste Teiler: 66.2 (26.), 90.2 (27.), 93.9 (21.)
 Trefferkreis: 8.25 mm
 Trefferlage: 0.21 mm links, 0.22 mm hoch

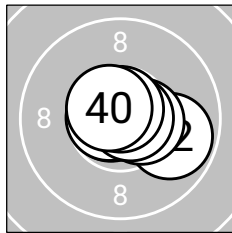
**Serie 4: 106.4** (99)

10.9*↑	9.9→	10.5*→	10.8*←	10.8*↖
10.7*←	10.7*←	10.7*→	10.8*↑	10.6*↖

beste Teiler: 8.2 (31.), 37.3 (35.), 49.0 (34.)
 Trefferkreis: 7.99 mm
 Trefferlage: 0.19 mm rechts, 0.06 mm hoch

LG 40 ZR

StandNr: 131

Trenkwalder, Hermann #70819202

Senioren_1m

Wertung

StartNr: 31

01.03.2026 10:01

SG_Kundl

SG Kundl 2

Ergebnis: **421.4 (399)**
 Serien: 103.9 105.3 106.1 106.1
 Zähler: 39 1 0 0 0 0 0 0 0 0
 Innenzehner: 37
 Weitest: 287 (7.), 219 (13.), 209 (9.)
 beste Teiler: 12.8 (12.), 19.2 (23.), 21.0 (35.)
 Trefferkreis: 9.57 mm
 Trefferlage: 0.13 mm rechts, 0.03 mm tief

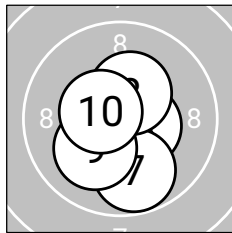
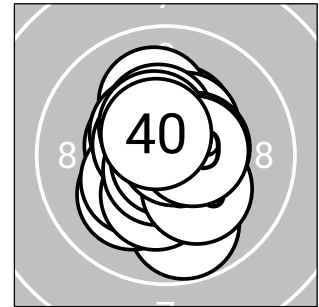
**Serie 1: 103.9 (99)**

10.5*→	10.7*↓	10.7*↗	10.5*↘	10.5*→
10.2*↓	9.8↓	10.4*↗	10.1↘	10.5*↖

beste Teiler: 53.8 (3.), 56.3 (2.), 104.5 (1.)
 Trefferkreis: 8.68 mm
 Trefferlage: 0.15 mm rechts, 0.61 mm tief

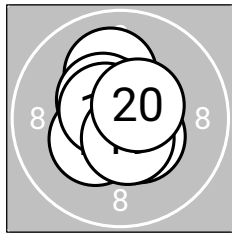
**Serie 2: 105.3 (100)**

10.7*↓	10.9*↖	10.1↑	10.7*↓	10.5*↘
10.3*↖	10.5*↖	10.6*↖	10.5*↘	10.5*↗

beste Teiler: 12.8 (12.), 68.2 (11.), 70.6 (14.)
 Trefferkreis: 7.96 mm
 Trefferlage: 0.16 mm links, 0.00 mm

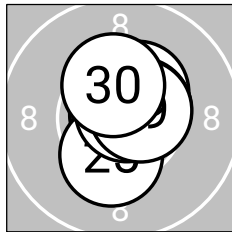
**Serie 3: 106.1 (100)**

10.8*→	10.5*↑	10.9*↑	10.8*↑	10.3*↓
10.4*↗	10.8*↗	10.6*↗	10.6*↗	10.4*↑

beste Teiler: 19.2 (23.), 27.1 (21.), 32.1 (24.)
 Trefferkreis: 7.56 mm
 Trefferlage: 0.22 mm rechts, 0.36 mm hoch

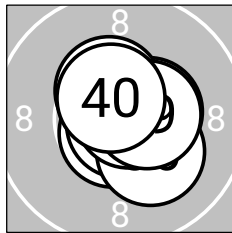
**Serie 4: 106.1 (100)**

10.7*↓	10.8*↑	10.7*↗	10.5*→	10.9*↓
10.2*↘	10.8*↗	10.4*↖	10.5*→	10.6*↖

beste Teiler: 21.0 (35.), 40.3 (37.), 44.2 (32.)
 Trefferkreis: 7.56 mm
 Trefferlage: 0.32 mm rechts, 0.13 mm hoch

Ergebnis: **420.1** (400)
 Serien: 105.2 105.2 105.0 104.7
 Zähler: 40 0 0 0 0 0 0 0 0 0 0
 Innenzehner: 37
 Weitester: 214 (5.), 210 (34.), 203 (37.)
 beste Teiler: 34.2 (21.), 34.5 (11.), 50.2 (13.)
 Trefferkreis: 8.67 mm
 Trefferlage: 0.15 mm links, 0.19 mm tief

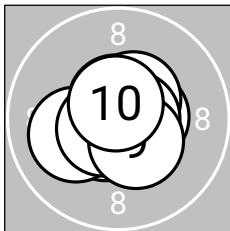
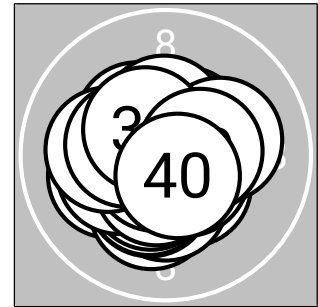

Serie 1: 105.2 (100)

10.5*→	10.5*↘	10.6*↙	10.6*↑	10.1↖
10.5*↗	10.7*→	10.6*↙	10.4*↘	10.7*↑

beste Teiler: 67.0 (7.), 73.9 (10.), 79.0 (4.)
 Trefferkreis: 7.74 mm
 Trefferlage: 0.05 mm rechts, 0.12 mm tief

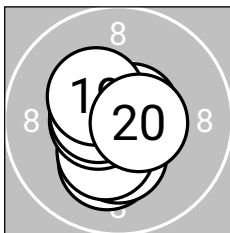

Serie 2: 105.2 (100)

10.8*↖	10.2*↘	10.8*→	10.3*↓	10.3*↘
10.7*↗	10.6*↖	10.6*↖	10.3*↖	10.6*→

beste Teiler: 34.5 (11.), 50.2 (13.), 68.5 (16.)
 Trefferkreis: 7.55 mm
 Trefferlage: 0.22 mm links, 0.29 mm tief

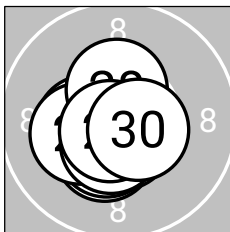

Serie 3: 105.0 (100)

10.8*↘	10.4*↘	10.4*↖	10.4*↘	10.6*↓
10.2*↖	10.5*↘	10.4*↑	10.7*↘	10.6*↘

beste Teiler: 34.2 (21.), 61.4 (29.), 85.5 (25.)
 Trefferkreis: 7.27 mm
 Trefferlage: 0.37 mm links, 0.50 mm tief

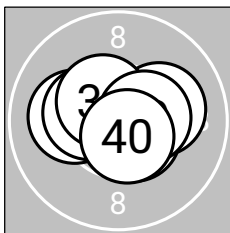

Serie 4: 104.7 (100)

10.6*↘	10.5*↖	10.7*→	10.1↖	10.7*↖
10.4*↖	10.1→	10.5*↖	10.5*→	10.6*↘

beste Teiler: 60.6 (35.), 68.7 (33.), 86.4 (40.)
 Trefferkreis: 8.58 mm
 Trefferlage: 0.07 mm links, 0.15 mm hoch



Ergebnis: **398.5** (381)
 Serien: 99.6 99.5 101.5 97.9
 Zähler: 23 15 2 0 0 0 0 0 0 0
 Innenzehner: 17
 Weitester: 697 (37.), 578 (15.), 485 (8.)
 beste Teiler: 52.0 (7.), 71.1 (26.), 81.3 (29.)
 Trefferkreis: 16.56 mm
 Trefferlage: 0.29 mm links, 0.68 mm tief

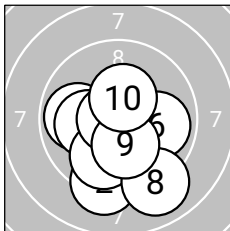
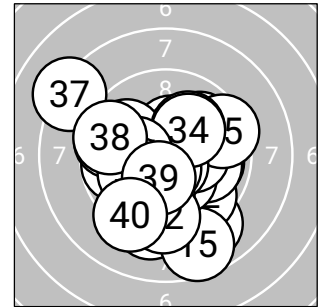

Serie 1: 99.6 (95)
 10.2*➡ 9.3↓ 9.9← 10.1← 9.9↓
 9.9➡ 10.7*← 9.0↓ 10.2*↓ 10.4*↑
 beste Teiler: 52.0 (7.), 143.3 (10.), 177.3 (9.)
 Trefferkreis: 11.22 mm
 Trefferlage: 0.05 mm rechts, 1.22 mm tief

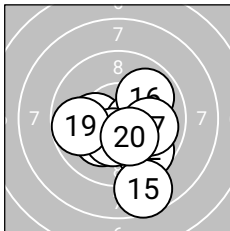

Serie 2: 99.5 (95)
 10.2*↙ 9.7↘ 10.2*← 10.5*➡ 8.6↓
 9.9↗ 10.0➡ 10.3*↓ 9.8← 10.3*↘
 beste Teiler: 125.9 (14.), 151.6 (18.), 164.8 (20.)
 Trefferkreis: 12.08 mm
 Trefferlage: 0.42 mm rechts, 1.24 mm tief

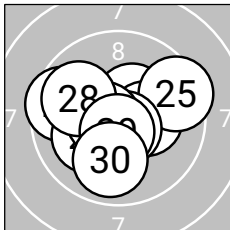

Serie 3: 101.5 (96)
 9.6← 10.4*↗ 10.1← 10.3*➡ 9.4↗
 10.7*↘ 10.6*← 9.9← 10.6*↓ 9.9↓
 beste Teiler: 71.1 (26.), 81.3 (29.), 89.2 (27.)
 Trefferkreis: 11.38 mm
 Trefferlage: 0.26 mm links, 0.05 mm tief

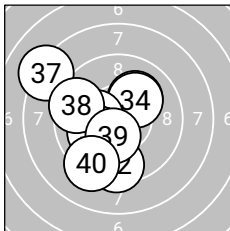

Serie 4: 97.9 (95)
 10.6*← 9.4↓ 10.1↗ 10.1↗ 10.2*←
 10.1← 8.2↙ 9.5← 10.4*↓ 9.3↓
 beste Teiler: 100.5 (31.), 146.4 (39.), 182.2 (35.)
 Trefferkreis: 13.94 mm
 Trefferlage: 1.40 mm links, 0.21 mm tief



Ergebnis: 418.0 (398)
Serien: 103.8 105.9 103.8 104.5
Zähler: 38 2 0 0 0 0 0 0 0 0
Innenzehner: 35
Weiteste: 308 (3.), 286 (38.), 232 (30.)
beste Teiler: 6.3 (6.), 32.0 (31.), 50.9 (33.)
Trefferkreis: 9.31 mm
Trefferlage: 0.34 mm rechts, 0.04 mm tief

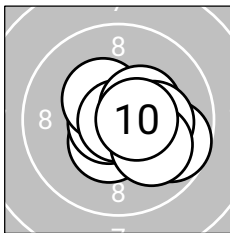
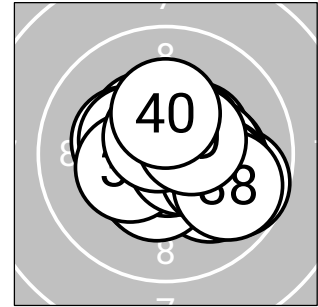

Serie 1: 103.8 (99)

10.4*↓ 10.7*← 9.7→ 10.6*↗ 10.4*↖
 10.9*↓ 10.4*↗ 10.2*→ 10.0→ 10.5*→

beste Teiler: 6.3 (6.), 54.4 (2.), 87.9 (4.)
Trefferkreis: 8.85 mm
Trefferlage: 0.76 mm rechts, 0.17 mm tief

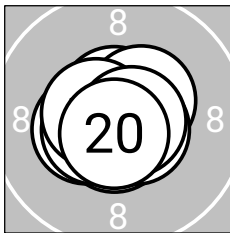

Serie 2: 105.9 (100)

10.6*↑ 10.6*↓ 10.4*← 10.7*↗ 10.5*↖
 10.5*↗ 10.6*↘ 10.6*← 10.7*→ 10.7*↓

beste Teiler: 54.5 (14.), 54.5 (19.), 61.4 (20.)
Trefferkreis: 7.05 mm
Trefferlage: 0.10 mm links, 0.06 mm tief

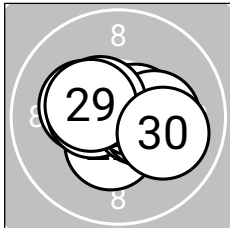

Serie 3: 103.8 (100)

10.3*← 10.4*↓ 10.4*← 10.5*→ 10.4*→
 10.6*↗ 10.3*→ 10.5*↖ 10.4*← 10.0→

beste Teiler: 89.6 (26.), 102.3 (24.), 113.8 (28.)
Trefferkreis: 8.55 mm
Trefferlage: 0.17 mm rechts, 0.00 mm

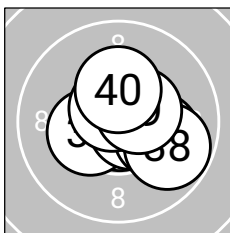

Serie 4: 104.5 (99)

10.8*↓ 10.3*← 10.8*↗ 10.6*↗ 10.7*→
 10.1→ 10.6*↖ 9.8→ 10.5*↗ 10.3*↑

beste Teiler: 32.0 (31.), 50.9 (33.), 73.3 (35.)
Trefferkreis: 8.76 mm
Trefferlage: 0.55 mm rechts, 0.07 mm hoch



LG 40 ZR

StandNr: 135

Rainer, Gerold #70819206

Senioren_1m

Wertung

StartNr: 35

01.03.2026 10:09

SG_Imst

SG Imst 3

Ergebnis: **412.4 (393)**
 Serien: 101.6 104.4 104.3 102.1
 Zähler: 33 7 0 0 0 0 0 0 0 0
 Innenzehner: 29
 Weitestе: 381 (7.), 369 (34.), 358 (4.)
 beste Teiler: 27.2 (1.), 52.1 (27.), 71.1 (3.)
 Trefferkreis: 12.01 mm
 Trefferlage: 0.10 mm links, 0.02 mm hoch

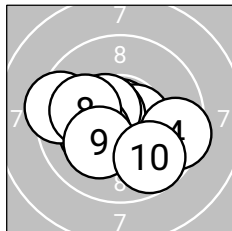
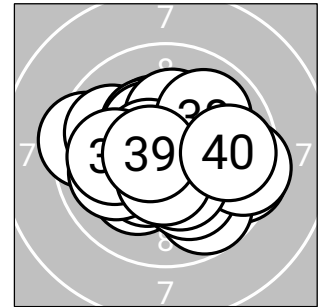
**Serie 1: 101.6 (97)**

10.8*↑	10.6*→	10.7*←	9.5→	10.5*←
10.2*←	9.4←	10.0←	10.2*↖	9.7↘

beste Teiler: 27.2 (1.), 71.1 (3.), 92.4 (2.)
 Trefferkreis: 11.89 mm
 Trefferlage: 0.43 mm links, 0.34 mm tief

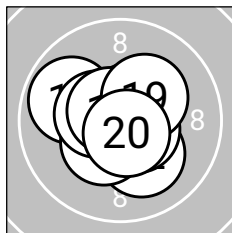
**Serie 2: 104.4 (99)**

9.9←	10.1↘	10.6*↘	10.6*↗	10.6*←
10.4*↖	10.5*←	10.7*←	10.3*↗	10.7*↘

beste Teiler: 72.1 (18.), 73.3 (20.), 93.0 (14.)
 Trefferkreis: 9.08 mm
 Trefferlage: 0.18 mm links, 0.04 mm tief

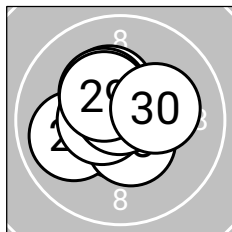
**Serie 3: 104.3 (100)**

10.7*↓	10.0←	10.5*↘	10.6*←	10.3*↑
10.6*←	10.7*↑	10.3*←	10.4*←	10.2*→

beste Teiler: 52.1 (27.), 71.3 (21.), 89.6 (24.)
 Trefferkreis: 8.82 mm
 Trefferlage: 0.40 mm links, 0.29 mm hoch

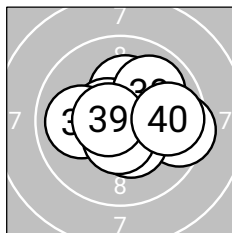
**Serie 4: 102.1 (97)**

10.5*↗	10.2*↑	10.6*←	9.5→	10.0←
10.4*↘	10.5*↓	9.9↗	10.7*←	9.8→

beste Teiler: 73.2 (39.), 88.5 (33.), 104.3 (37.)
 Trefferkreis: 10.57 mm
 Trefferlage: 0.61 mm rechts, 0.18 mm hoch

LG 40 ZR

StandNr: 136

Greber, Markus #70819207

Senioren_1m

Wertung

StartNr: 36

01.03.2026 09:45

SG_Fügenberg

SG Fügenberg 1

Ergebnis: **420.0** (398)
 Serien: 104.6 105.1 105.9 104.4
 Zähler: 38 2 0 0 0 0 0 0 0 0
 Innenzehner: 35
 Weitester: 262 (39.), 253 (12.), 216 (15.)
 beste Teiler: 33.6 (22.), 39.9 (2.), 52.4 (28.)
 Trefferkreis: 9.20 mm
 Trefferlage: 0.27 mm rechts, 0.18 mm tief

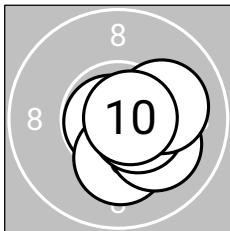
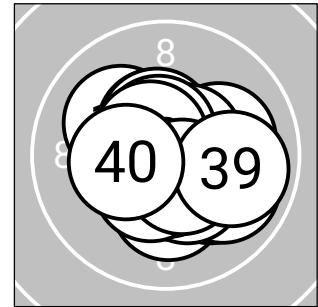

Serie 1: 104.6 (100)

10.4*➡	10.8*⬅	10.5*➡	10.6*➡	10.6*➡
10.2*↓	10.1*➡	10.6*➡	10.1*➡	10.7*➡

beste Teiler: 39.9 (2.), 58.2 (10.), 81.0 (4.)
 Trefferkreis: 7.64 mm
 Trefferlage: 0.92 mm rechts, 0.37 mm tief

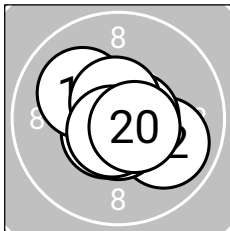

Serie 2: 105.1 (99)

10.6*⬆	9.9*➡	10.7*➡	10.6*⬆	10.1*⬆
10.6*↓	10.7*➡	10.6*⬆	10.7*⬆	10.6*➡

beste Teiler: 67.5 (13.), 70.6 (19.), 75.1 (17.)
 Trefferkreis: 9.19 mm
 Trefferlage: 0.12 mm rechts, 0.11 mm tief

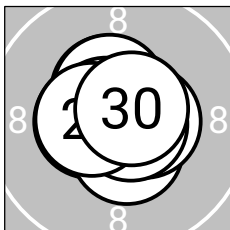

Serie 3: 105.9 (100)

10.5*⬆	10.8*➡	10.5*⬅	10.5*⬆	10.5*↓
10.5*➡	10.7*⬆	10.7*➡	10.5*⬅	10.7*↗

beste Teiler: 33.6 (22.), 52.4 (28.), 53.6 (27.)
 Trefferkreis: 6.84 mm
 Trefferlage: 0.07 mm links, 0.15 mm hoch

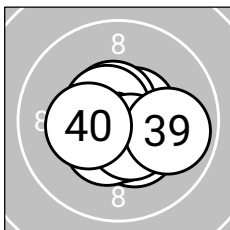

Serie 4: 104.4 (99)

10.6*↗	10.6*⬆	10.6*⬆	10.4*↓	10.5*⬆
10.6*↓	10.4*⬆	10.5*➡	9.9*➡	10.3*⬅

beste Teiler: 88.4 (33.), 91.3 (32.), 94.8 (31.)
 Trefferkreis: 8.64 mm
 Trefferlage: 0.11 mm rechts, 0.37 mm tief



Ergebnis: **418.1** (396)
 Serien: 104.4 106.2 104.4 103.1
 Zähler: 36 4 0 0 0 0 0 0 0 0
 Innenzehner: 34
 Weitester: 322 (24.), 312 (6.), 260 (33.)
 beste Teiler: 8.5 (13.), 13.9 (11.), 32.3 (8.)
 Trefferkreis: 10.67 mm
 Trefferlage: 0.15 mm links, 0.06 mm tief

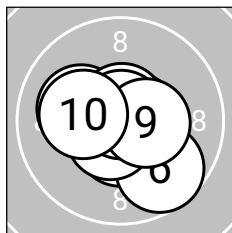
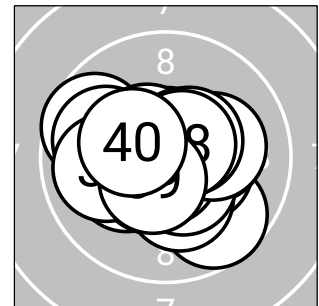

Serie 1: 104.4 (99)

10.6*➔	10.5*↓	10.1↔	10.8*➔	10.7*↑
9.7↘	10.6*↖	10.8*↑	10.4*➔	10.2*↔

beste Teiler: 32.3 (8.), 37.1 (4.), 67.4 (5.)
 Trefferkreis: 9.49 mm
 Trefferlage: 0.01 mm rechts, 0.22 mm tief

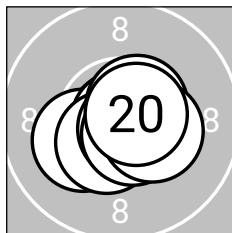

Serie 2: 106.2 (100)

10.9*↙	10.2*↖	10.9*➔	10.5*↙	10.7*↘
10.7*↘	10.6*↗	10.6*↘	10.4*➔	10.7*➔

beste Teiler: 8.5 (13.), 13.9 (11.), 51.6 (16.)
 Trefferkreis: 7.56 mm
 Trefferlage: 0.20 mm rechts, 0.29 mm tief

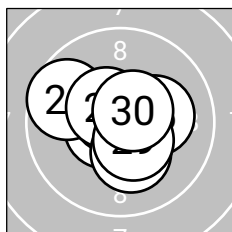

Serie 3: 104.4 (99)

10.6*↖	10.6*↖	10.7*↖	9.7↖	10.8*↑
10.2*➔	10.5*↖	10.2*↓	10.5*↘	10.6*↗

beste Teiler: 42.0 (25.), 70.7 (23.), 93.0 (22.)
 Trefferkreis: 9.48 mm
 Trefferlage: 0.20 mm links, 0.13 mm hoch

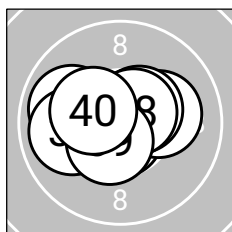

Serie 4: 103.1 (98)

10.3*↖	10.7*↓	9.9↖	10.1➔	10.3*↖
10.5*↗	9.9↖	10.6*↗	10.5*↙	10.3*↖

beste Teiler: 57.0 (32.), 86.8 (38.), 108.9 (39.)
 Trefferkreis: 9.04 mm
 Trefferlage: 0.64 mm links, 0.14 mm hoch



Ergebnis: **421.9** (400)
 Serien: 105.7 104.7 105.6 105.9
 Zähler: 40 0 0 0 0 0 0 0 0 0 0
 Innenzehner: 40
 Weitester: 179 (18.), 171 (10.), 146 (29.)
 beste Teiler: 30.3 (24.), 33.0 (9.), 35.8 (20.)
 Trefferkreis: 7.71 mm
 Trefferlage: 0.13 mm links, 0.10 mm hoch

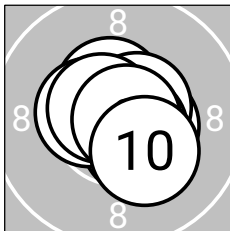
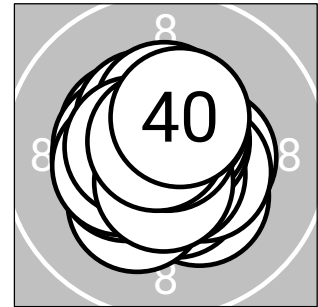

Serie 1: 105.7 (100)

10.5*↑	10.5*→	10.7*→	10.6*→	10.5*↓
10.7*→	10.5*←	10.6*←	10.8*→	10.3*→

beste Teiler: 33.0 (9.), 56.4 (3.), 74.6 (6.)
 Trefferkreis: 7.38 mm
 Trefferlage: 0.28 mm rechts, 0.10 mm tief

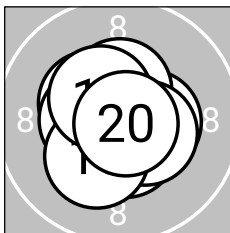

Serie 2: 104.7 (100)

10.6*←	10.4*←	10.4*→	10.4*↑	10.5*↓
10.4*→	10.5*←	10.2*↓	10.5*←	10.8*→

beste Teiler: 35.8 (20.), 96.1 (11.), 111.4 (15.)
 Trefferkreis: 7.53 mm
 Trefferlage: 0.18 mm links, 0.03 mm tief

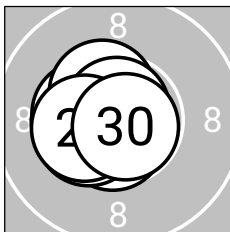

Serie 3: 105.6 (100)

10.7*↓	10.4*←	10.5*←	10.8*↑	10.4*←
10.4*←	10.4*←	10.8*↑	10.4*←	10.8*→

beste Teiler: 30.3 (24.), 41.0 (30.), 41.5 (28.)
 Trefferkreis: 6.47 mm
 Trefferlage: 0.71 mm links, 0.09 mm hoch

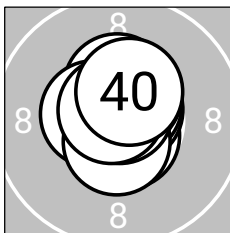

Serie 4: 105.9 (100)

10.7*↓	10.4*↑	10.7*→	10.6*→	10.5*←
10.6*↓	10.5*→	10.8*↑	10.7*←	10.4*→

beste Teiler: 45.2 (38.), 53.5 (39.), 65.7 (33.)
 Trefferkreis: 6.78 mm
 Trefferlage: 0.07 mm rechts, 0.46 mm hoch

LG 40 ZR

StandNr: 139

Oberhauser, Wolfgang #70819210**Senioren_1m**

Wertung

StartNr: 39

01.03.2026 09:54

SG_Angerberg

SG Angerberg 1

Ergebnis: **419.2** (397)
 Serien: 104.1 103.9 105.4 105.8
 Zähler: 37 3 0 0 0 0 0 0 0 0
 Innenzehner: 34
 Weitest: 313 (10.), 275 (28.), 259 (11.)
 beste Teiler: 12.0 (22.), 19.2 (19.), 20.0 (38.)
 Trefferkreis: 10.33 mm
 Trefferlage: 0.12 mm rechts, 0.03 mm tief

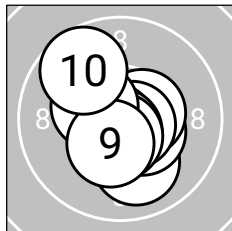
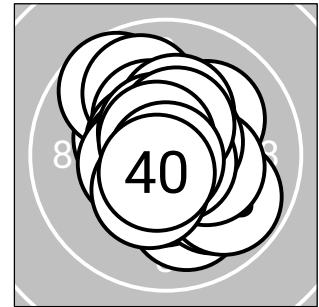
**Serie 1: 104.1** (99)

10.0 ↘ 10.4* ↗ 10.5* ↗ 10.7* ↗ 10.7* ↗
 10.7* ↘ 10.6* ↘ 10.4* ↗ 10.4* ↘ 9.7 ↗

beste Teiler: 56.5 (5.), 66.6 (6.), 67.5 (4.)
 Trefferkreis: 9.92 mm
 Trefferlage: 0.06 mm links, 0.29 mm tief

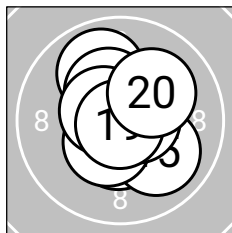
**Serie 2: 103.9** (99)

9.9 ↗ 10.3* ↗ 10.7* ↗ 10.4* ↘ 10.0 ↗
 10.4* ↘ 10.6* ↗ 10.6* ↗ 10.9* ↘ 10.1 ↗

beste Teiler: 19.2 (19.), 56.0 (13.), 81.3 (18.)
 Trefferkreis: 9.35 mm
 Trefferlage: 0.04 mm rechts, 0.14 mm hoch

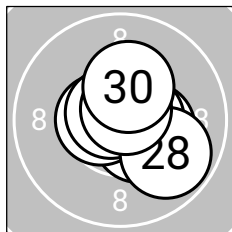
**Serie 3: 105.4** (99)

10.8* ↗ 10.9* ↗ 10.4* ↗ 10.5* ↗ 10.6* ↗
 10.6* ↗ 10.7* ↗ 9.9 ↗ 10.7* ↗ 10.3* ↗

beste Teiler: 12.0 (22.), 37.0 (21.), 59.2 (27.)
 Trefferkreis: 8.33 mm
 Trefferlage: 0.48 mm rechts, 0.01 mm hoch

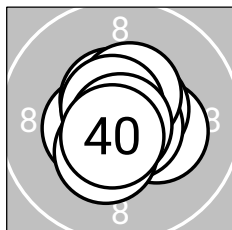
**Serie 4: 105.8** (100)

10.3* ↗ 10.6* ↗ 10.5* ↗ 10.6* ↗ 10.7* ↗
 10.5* ↗ 10.7* ↗ 10.9* ↘ 10.4* ↘ 10.6* ↘

beste Teiler: 20.0 (38.), 55.5 (35.), 69.4 (37.)
 Trefferkreis: 7.29 mm
 Trefferlage: 0.03 mm rechts, 0.01 mm tief