

Ergebnis: **415.6** (397)
 Serien: 103.6 104.6 104.3 103.1
 Zähler: 37 3 0 0 0 0 0 0 0 0
 Innenzehner: 32
 Weitester: 301 (26.), 301 (36.), 276 (9.)
 beste Teiler: 27.1 (22.), 39.4 (19.), 48.0 (12.)
 Trefferkreis: 10.25 mm
 Trefferlage: 0.00 mm , 0.23 mm hoch

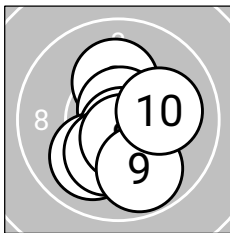
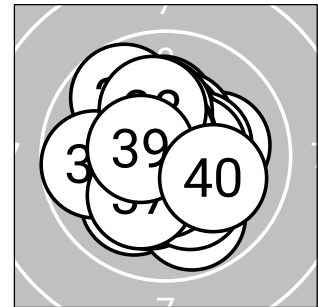

Serie 1: 103.6 (99)

10.7*↗	10.6*↑	10.2*↑	10.7*↑	10.0↘
10.7*↘	10.2*↘	10.6*↘	9.8↘	10.1↗

beste Teiler: 51.4 (4.), 60.4 (6.), 67.9 (1.)
 Trefferkreis: 9.17 mm
 Trefferlage: 0.22 mm rechts, 0.32 mm tief

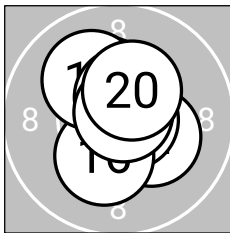

Serie 2: 104.6 (100)

10.3*↘	10.8*→	10.5*↖	10.7*↗	10.3*↖
10.2*↘	10.1↖	10.5*↑	10.8*↗	10.4*↗

beste Teiler: 39.4 (19.), 48.0 (12.), 72.4 (14.)
 Trefferkreis: 8.34 mm
 Trefferlage: 0.05 mm rechts, 0.52 mm hoch

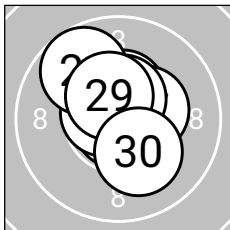

Serie 3: 104.3 (99)

10.6*↖	10.8*↘	10.4*↑	10.7*↘	10.6*↖
9.7↖	10.4*↗	10.5*↑	10.4*↖	10.2*↘

beste Teiler: 27.1 (22.), 69.3 (24.), 79.6 (25.)
 Trefferkreis: 9.48 mm
 Trefferlage: 0.02 mm rechts, 0.53 mm hoch

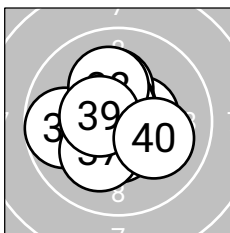

Serie 4: 103.1 (99)

10.5*↗	10.5*↘	10.2*↑	10.6*↑	10.7*↑
9.7↖	10.2*↘	10.1↖	10.5*↖	10.1↘

beste Teiler: 74.9 (35.), 88.2 (34.), 109.2 (39.)
 Trefferkreis: 9.52 mm
 Trefferlage: 0.31 mm links, 0.18 mm hoch



Ergebnis: **415.3** (397)
 Serien: 104.6 101.0 104.5 105.2
 Zähler: 38 1 1 0 0 0 0 0 0 0
 Innenzehner: 31
 Weitester: 732 (12.), 261 (11.), 249 (31.)
 beste Teiler: 8.5 (32.), 9.4 (4.), 38.6 (5.)
 Trefferkreis: 14.18 mm
 Trefferlage: 0.03 mm links, 0.15 mm tief

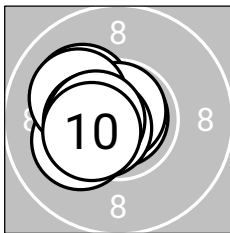
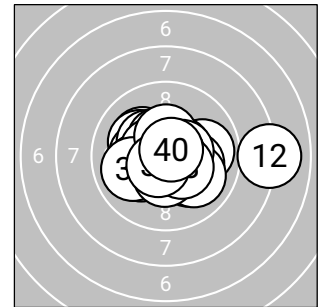

Serie 1: 104.6 (100)

10.5*← 10.1↖ 10.2*← 10.9*↗ 10.8*↑
 10.6*← 10.1↖ 10.5*← 10.5*← 10.4*←

beste Teiler: 9.4 (4.), 38.6 (5.), 81.4 (6.)
 Trefferkreis: 6.90 mm
 Trefferlage: 1.05 mm links, 0.10 mm hoch

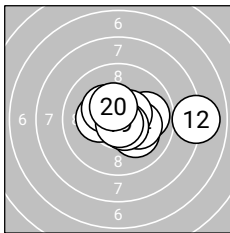

Serie 2: 101.0 (97)

9.9→ 8.0→ 10.1↘ 10.2*↘ 10.2*←
 10.5*↗ 10.3*↖ 10.6*↘ 10.8*↓ 10.4*↗

beste Teiler: 40.5 (19.), 89.1 (18.), 107.0 (16.)
 Trefferkreis: 13.58 mm
 Trefferlage: 1.16 mm rechts, 0.02 mm hoch

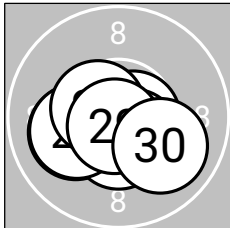

Serie 3: 104.5 (100)

10.1← 10.7*↓ 10.7*→ 10.5*↘ 10.6*←
 10.5*↓ 10.1← 10.5*← 10.8*↓ 10.0↘

beste Teiler: 47.5 (29.), 52.6 (22.), 70.2 (23.)
 Trefferkreis: 8.57 mm
 Trefferlage: 0.28 mm links, 0.54 mm tief

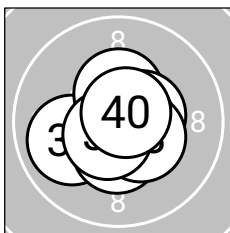

Serie 4: 105.2 (100)

10.0← 10.9*↘ 10.6*↓ 10.4*↑ 10.4*↓
 10.5*→ 10.7*→ 10.4*↘ 10.6*← 10.7*↗

beste Teiler: 8.5 (32.), 54.4 (37.), 58.8 (40.)
 Trefferkreis: 8.16 mm
 Trefferlage: 0.02 mm rechts, 0.23 mm tief



LG 40 ZR

StandNr: 126

Schneider, Christian #70819023**Senioren_1m**

Wertung

StartNr: 165

01.03.2026 14:05

SG_Zirl

SG Zirl 2

Ergebnis: **398.3** (381)
 Serien: 100.9 100.2 100.2 97.0
 Zähler: 24 13 3 0 0 0 0 0 0 0
 Innenzehner: 14
 Weitestе: 595 (35.), 548 (5.), 548 (36.)
 beste Teiler: 56.0 (18.), 61.5 (29.), 65.9 (3.)
 Trefferkreis: 15.17 mm
 Trefferlage: 0.34 mm rechts, 0.85 mm hoch

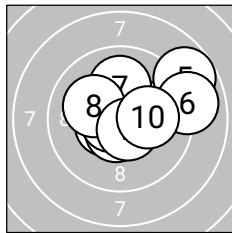
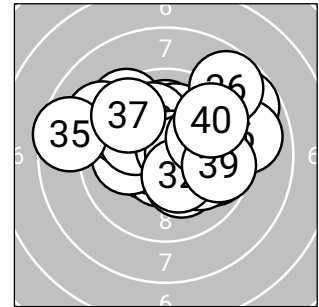
**Serie 1: 100.9** (97)

10.5* \leftarrow 10.6* \downarrow 10.7* \leftarrow 10.4* \rightarrow 8.8 \rightarrow
 9.0 \rightarrow 10.0 \uparrow 10.1 \leftarrow 10.6* \downarrow 10.2* \rightarrow

beste Teiler: 65.9 (3.), 93.2 (9.), 93.3 (2.)
 Trefferkreis: 11.36 mm
 Trefferlage: 0.94 mm rechts, 0.57 mm hoch

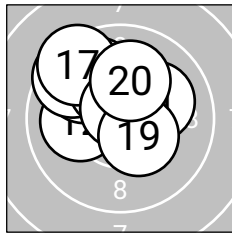
**Serie 2: 100.2** (96)

10.1 \rightarrow 10.1 \leftarrow 9.8 \leftarrow 9.9 \leftarrow 9.5 \leftarrow
 10.2* \leftarrow 9.4 \leftarrow 10.7* \uparrow 10.4* \downarrow 10.1 \uparrow

beste Teiler: 56.0 (18.), 140.7 (19.), 189.4 (16.)
 Trefferkreis: 9.73 mm
 Trefferlage: 0.77 mm links, 1.38 mm hoch

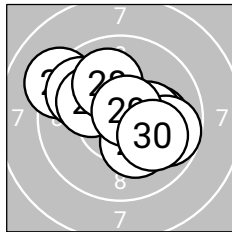
**Serie 3: 100.2** (97)

10.2* \downarrow 9.2 \leftarrow 10.1 \rightarrow 10.3* \rightarrow 9.8 \leftarrow
 9.8 \rightarrow 10.1 \leftarrow 10.0 \leftarrow 10.7* \nearrow 10.0 \searrow

beste Teiler: 61.5 (29.), 173.1 (24.), 181.4 (21.)
 Trefferkreis: 11.90 mm
 Trefferlage: 0.12 mm rechts, 0.40 mm hoch

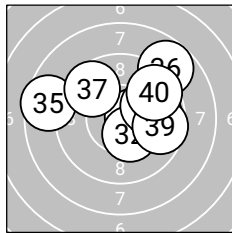
**Serie 4: 97.0** (91)

10.6* \rightarrow 10.4* \downarrow 9.9 \rightarrow 9.9 \rightarrow 8.6 \leftarrow
 8.8 \nearrow 9.6 \leftarrow 10.0 \rightarrow 9.6 \rightarrow 9.6 \rightarrow

beste Teiler: 100.4 (31.), 145.6 (32.), 247.8 (38.)
 Trefferkreis: 14.46 mm
 Trefferlage: 1.08 mm rechts, 1.07 mm hoch

Ergebnis: **413.7 (395)**
 Serien: 103.2 102.7 103.5 104.3
 Zähler: 35 5 0 0 0 0 0 0 0 0
 Innenzehner: 30
 Weitester: 314 (21.), 313 (16.), 306 (10.)
 beste Teiler: 48.7 (30.), 61.1 (27.), 68.2 (15.)
 Trefferkreis: 10.70 mm
 Trefferlage: 0.00 mm , 0.19 mm hoch

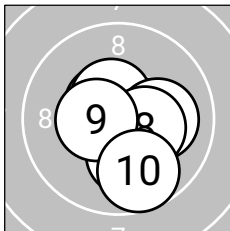
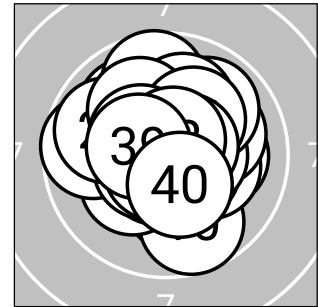

Serie 1: 103.2 (99)

10.5*→	10.2*↓	10.3*↘	10.5*↖	10.6*↙
10.5*↗	10.1→	10.3*→	10.5*←	9.7↓

beste Teiler: 100.9 (5.), 101.8 (4.), 104.0 (1.)
 Trefferkreis: 8.67 mm
 Trefferlage: 0.56 mm rechts, 0.55 mm tief

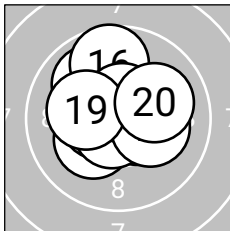

Serie 2: 102.7 (99)

10.2*↙	10.5*←	10.5*→	10.0↖	10.7*↙
9.7↑	10.6*↑	10.2*→	10.2*←	10.1→

beste Teiler: 68.2 (15.), 92.6 (17.), 106.3 (12.)
 Trefferkreis: 9.17 mm
 Trefferlage: 0.15 mm links, 0.45 mm hoch

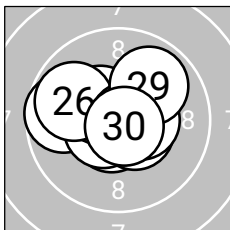

Serie 3: 103.5 (97)

9.7←	10.6*↙	10.5*↘	10.6*↖	10.4*↖
9.9↖	10.7*→	10.4*→	9.9↗	10.8*↘

beste Teiler: 48.7 (30.), 61.1 (27.), 82.2 (22.)
 Trefferkreis: 9.61 mm
 Trefferlage: 0.30 mm links, 0.20 mm hoch

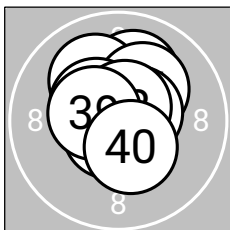

Serie 4: 104.3 (100)

10.1↑	10.1↖	10.6*↖	10.2*↗	10.7*↙
10.6*↗	10.4*↖	10.7*↑	10.5*←	10.4*↙

beste Teiler: 68.4 (35.), 73.8 (38.), 83.0 (33.)
 Trefferkreis: 8.17 mm
 Trefferlage: 0.07 mm links, 0.64 mm hoch

LG 40 ZR

StandNr: 128

Dannemüller, Franz #70819025

Senioren_1m

Wertung

StartNr: 167

01.03.2026 14:04

SG_Thaur

SG Thaur 1

Ergebnis: **418.3** (397)
 Serien: 105.8 104.6 103.8 104.1
 Zähler: 37 3 0 0 0 0 0 0 0 0
 Innenzehner: 33
 Weitester: 278 (22.), 267 (37.), 254 (20.)
 beste Teiler: 8.5 (38.), 38.2 (8.), 40.6 (6.)
 Trefferkreis: 9.79 mm
 Trefferlage: 0.32 mm rechts, 0.27 mm hoch

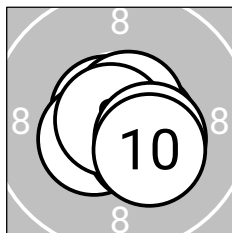
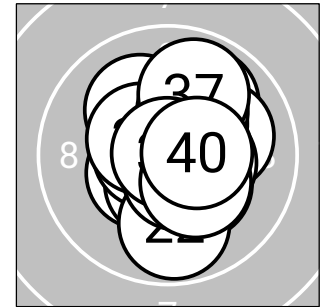
**Serie 1: 105.8** (100)

10.6*→	10.7*↖	10.7*↘	10.4*↖	10.4*↘
10.8*→	10.7*↗	10.8*←	10.4*↗	10.3*↘

beste Teiler: 38.2 (8.), 40.6 (6.), 62.7 (7.)
 Trefferkreis: 6.87 mm
 Trefferlage: 0.25 mm rechts, 0.34 mm tief

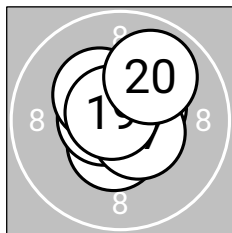
**Serie 2: 104.6** (99)

10.6*↘	10.5*↘	10.5*↗	10.4*↗	10.6*↖
10.6*←	10.5*↘	10.3*↖	10.7*↖	9.9↗

beste Teiler: 55.9 (19.), 78.6 (16.), 86.6 (15.)
 Trefferkreis: 8.16 mm
 Trefferlage: 0.05 mm rechts, 0.34 mm hoch

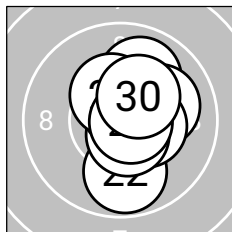
**Serie 3: 103.8** (99)

10.0↗	9.8↓	10.8*↗	10.1→	10.4*→
10.6*↘	10.7*↗	10.4*↖	10.7*→	10.3*↗

beste Teiler: 48.8 (23.), 57.7 (29.), 72.3 (27.)
 Trefferkreis: 9.58 mm
 Trefferlage: 0.66 mm rechts, 0.28 mm hoch

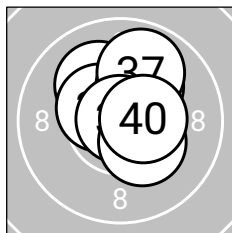
**Serie 4: 104.1** (99)

10.5*↗	10.1↖	10.5*↗	10.5*↖	10.8*↗
10.1↗	9.9↗	10.9*↖	10.3*↘	10.5*→

beste Teiler: 8.5 (38.), 42.4 (35.), 106.3 (31.)
 Trefferkreis: 8.31 mm
 Trefferlage: 0.35 mm rechts, 0.80 mm hoch

Ergebnis: **411.3 (394)**
 Serien: 103.3 102.1 102.2 103.7
 Zähler: 34 6 0 0 0 0 0 0 0 0 0
 Innenzehner: 29
 Weitester: 360 (19.), 348 (7.), 341 (25.)
 beste Teiler: 66.4 (36.), 67.0 (8.), 75.0 (17.)
 Trefferkreis: 10.61 mm
 Trefferlage: 0.29 mm links, 0.47 mm hoch

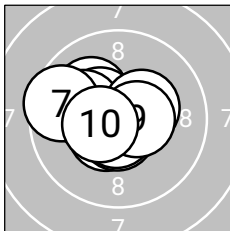
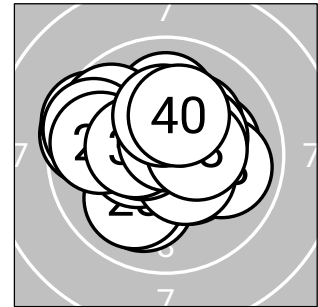

Serie 1: 103.3 (99)

10.1 ↖	10.4* ↖	10.1 ↖	10.5* ↖	10.3* ↗
10.6* ↓	9.6 ↖	10.7* ↓	10.5* →	10.5* ↖

beste Teiler: 67.0 (8.), 81.2 (6.), 109.8 (4.)
 Trefferkreis: 9.25 mm
 Trefferlage: 0.76 mm links, 0.18 mm hoch

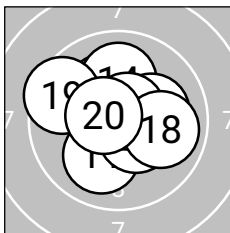

Serie 2: 102.1 (98)

10.1 ↙	10.5* ↖	10.2* ↖	10.0 ↑	10.2* ↗
10.4* ↘	10.7* ↗	9.9 →	9.5 ↖	10.6* ↖

beste Teiler: 75.0 (17.), 90.7 (20.), 123.8 (12.)
 Trefferkreis: 10.61 mm
 Trefferlage: 0.04 mm links, 0.45 mm hoch

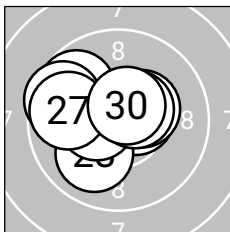

Serie 3: 102.2 (97)

10.6* ↗	10.5* →	10.0 ↙	9.7 ↖	9.6 ↖
10.5* ↖	9.8 ↖	10.4* ↗	10.5* ↗	10.6* ↗

beste Teiler: 89.1 (21.), 96.7 (30.), 103.5 (22.)
 Trefferkreis: 9.18 mm
 Trefferlage: 0.67 mm links, 0.44 mm hoch

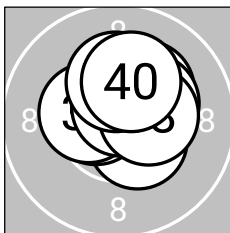

Serie 4: 103.7 (100)

10.5* ↘	10.3* ↑	10.5* ↖	10.4* ↖	10.2* ↗
10.7* ↑	10.3* ↗	10.4* →	10.2* ↑	10.2* ↗

beste Teiler: 66.4 (36.), 104.5 (33.), 120.2 (31.)
 Trefferkreis: 7.40 mm
 Trefferlage: 0.32 mm rechts, 0.80 mm hoch



Ergebnis: **419.4** (397)
 Serien: 106.2 103.7 103.7 105.8
 Zähler: 37 3 0 0 0 0 0 0 0 0
 Innenzehner: 34
 Weitester: 354 (29.), 291 (36.), 263 (24.)
 beste Teiler: 8.0 (34.), 11.3 (40.), 23.0 (8.)
 Trefferkreis: 10.88 mm
 Trefferlage: 0.10 mm links, 0.03 mm tief

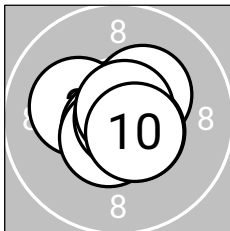
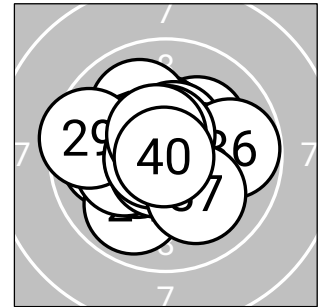

Serie 1: 106.2 (100)

10.8*↑	10.2*←	10.3*↗	10.7*↙	10.7*↓
10.6*↘	10.6*↙	10.9*→	10.8*↗	10.6*↘

beste Teiler: 23.0 (8.), 42.0 (1.), 50.4 (9.)
 Trefferkreis: 7.56 mm
 Trefferlage: 0.04 mm rechts, 0.05 mm tief

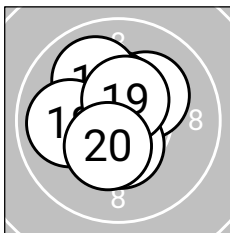

Serie 2: 103.7 (100)

10.7*↓	10.5*↙	10.2*↗	10.4*↑	10.5*↓
10.5*↑	10.0*←	10.0*←	10.5*↗	10.4*↙

beste Teiler: 52.9 (11.), 106.5 (12.), 112.8 (19.)
 Trefferkreis: 8.64 mm
 Trefferlage: 0.30 mm links, 0.29 mm hoch

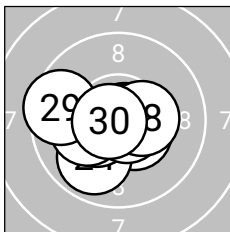

Serie 3: 103.7 (98)

10.8*→	10.6*→	10.5*↘	9.9↙	10.4*←
10.2*←	10.7*↘	10.4*→	9.5←	10.7*←

beste Teiler: 37.0 (21.), 54.5 (30.), 60.7 (27.)
 Trefferkreis: 9.44 mm
 Trefferlage: 0.44 mm links, 0.36 mm tief

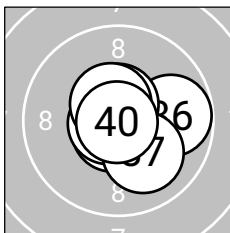

Serie 4: 105.8 (99)

10.7*↙	10.8*↗	10.8*←	10.9*↙	10.7*←
9.8→	10.1↘	10.6*↑	10.5*↗	10.9*↙

beste Teiler: 8.0 (34.), 11.3 (40.), 31.9 (33.)
 Trefferkreis: 8.08 mm
 Trefferlage: 0.28 mm rechts, 0.01 mm tief



Ergebnis: **407.0 (391)**
 Serien: 102.5 100.7 102.8 101.0
 Zähler: 31 9 0 0 0 0 0 0 0 0
 Innenezehner: 23
 Weitestе: 478 (15.), 401 (38.), 398 (35.)
 beste Teiler: 2.0 (33.), 53.4 (16.), 62.5 (25.)
 Trefferkreis: 12.76 mm
 Trefferlage: 0.56 mm links, 0.16 mm tief

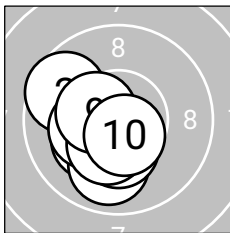
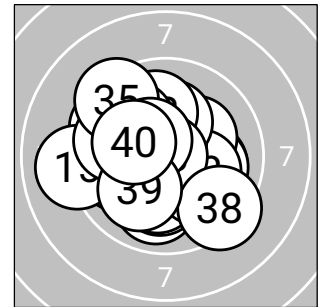

Serie 1: 102.5 (98)

10.2*↙	9.6↖	10.2*↓	9.9↓	10.6*↘
10.3*↙	10.3*↓	10.4*↘	10.4*↖	10.6*↓

beste Teiler: 83.2 (5.), 92.4 (10.), 129.0 (9.)
 Trefferkreis: 9.15 mm
 Trefferlage: 0.91 mm links, 0.80 mm tief

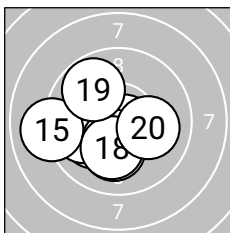

Serie 2: 100.7 (97)

10.1↓	10.4*↘	10.1↖	9.9↖	9.0↖
10.7*↘	10.4*↓	10.2*↓	9.8↖	10.1→

beste Teiler: 53.4 (16.), 143.0 (17.), 143.3 (12.)
 Trefferkreis: 11.38 mm
 Trefferlage: 0.98 mm links, 0.76 mm tief

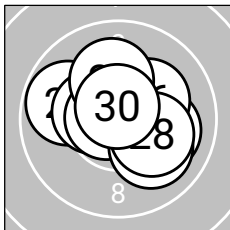

Serie 3: 102.8 (99)

10.6*↗	9.8↖	10.4*↖	10.1→	10.7*↖
10.2*↗	10.0↘	10.2*↗	10.1↑	10.7*↑

beste Teiler: 62.5 (25.), 67.2 (30.), 96.7 (21.)
 Trefferkreis: 9.58 mm
 Trefferlage: 0.31 mm rechts, 0.24 mm hoch

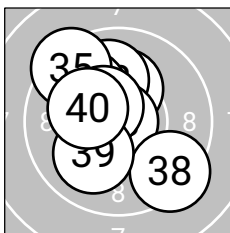

Serie 4: 101.0 (97)

10.2*↑	10.0↑	10.9*↖	9.9↖	9.4↖
10.5*↖	10.5*↖	9.3↘	10.1↖	10.2*↖

beste Teiler: 2.0 (33.), 120.2 (37.), 124.7 (36.)
 Trefferkreis: 12.50 mm
 Trefferlage: 0.68 mm links, 0.65 mm hoch



Ergebnis: **411.6** (393)
 Serien: 102.9 102.1 102.9 103.7
 Zähler: 33 7 0 0 0 0 0 0 0 0 0
 Innenzehner: 28
 Weitester: 396 (18.), 347 (36.), 320 (19.)
 beste Teiler: 18.6 (24.), 38.9 (17.), 55.7 (1.)
 Trefferkreis: 10.66 mm
 Trefferlage: 0.34 mm rechts, 0.00 mm

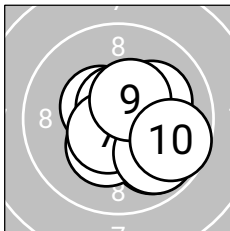
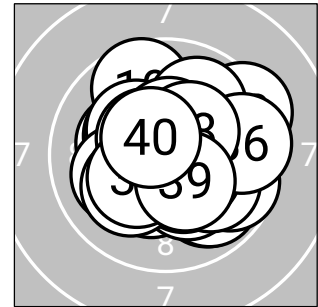

Serie 1: 102.9 (97)

10.7*↖	10.1↗	9.9↘	10.5*↖	10.3*↘
10.7*↑	10.6*↙	9.9↘	10.5*↗	9.7↘

beste Teiler: 55.7 (1.), 68.5 (6.), 94.2 (7.)
 Trefferkreis: 8.77 mm
 Trefferlage: 0.66 mm rechts, 0.33 mm tief

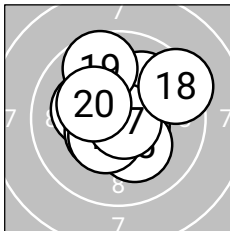

Serie 2: 102.1 (98)

10.6*↘	10.1↗	10.2*↖	10.4*↙	10.2*↘
10.4*↙	10.8*↘	9.4↗	9.7↖	10.3*↖

beste Teiler: 38.9 (17.), 94.3 (11.), 126.5 (14.)
 Trefferkreis: 9.95 mm
 Trefferlage: 0.09 mm rechts, 0.41 mm hoch

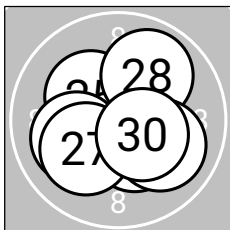

Serie 3: 102.9 (99)

10.6*↗	10.2*↘	10.4*↘	10.9*↙	10.3*↖
10.1↖	10.1↙	9.9↗	10.0↘	10.4*↘

beste Teiler: 18.6 (24.), 82.2 (21.), 136.8 (30.)
 Trefferkreis: 9.25 mm
 Trefferlage: 0.23 mm rechts, 0.24 mm tief

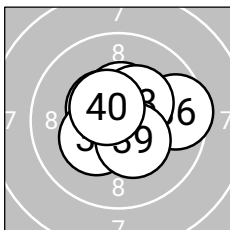

Serie 4: 103.7 (99)

10.5*↗	10.6*↙	10.5*↖	10.5*↘	10.4*↑
9.6↗	10.3*↙	10.4*↗	10.4*↘	10.5*↖

beste Teiler: 87.6 (32.), 104.9 (40.), 116.2 (31.)
 Trefferkreis: 9.47 mm
 Trefferlage: 0.37 mm rechts, 0.20 mm hoch



Ergebnis: **415.1 (397)**
Serien: 102.7 103.7 104.1 104.6
Zähler: 37 3 0 0 0 0 0 0 0 0
Innenzehner: 32
Weiteste: 268 (10.), 262 (11.), 258 (25.)
beste Teiler: 32.2 (19.), 37.3 (29.), 48.3 (24.)
Trefferkreis: 9.40 mm
Trefferlage: 0.00 mm , 0.12 mm tief

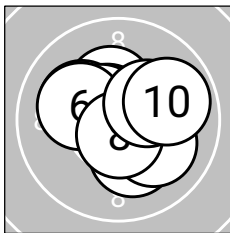
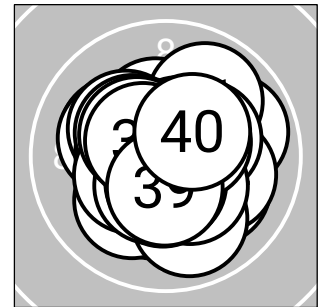

Serie 1: 102.7 (99)

10.3*↑ 10.6*↖ 10.1↙ 10.5*↖ 10.2*↓
 10.1↙ 10.1↘ 10.6*↓ 10.3*↗ 9.9↘

beste Teiler: 77.4 (8.), 84.2 (2.), 107.6 (4.)
Trefferkreis: 9.02 mm
Trefferlage: 0.09 mm rechts, 0.23 mm hoch

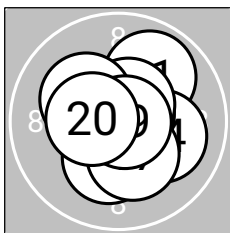

Serie 2: 103.7 (99)

9.9↗ 10.5*↘ 10.2*↓ 10.1↘ 10.7*↗
 10.6*↗ 10.3*↘ 10.2*↖ 10.8*↗ 10.4*↖

beste Teiler: 32.2 (19.), 58.0 (15.), 95.5 (16.)
Trefferkreis: 8.86 mm
Trefferlage: 0.30 mm rechts, 0.05 mm tief

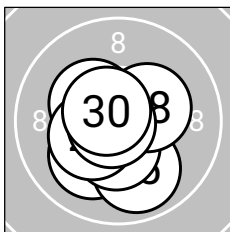

Serie 3: 104.1 (99)

10.6*↓ 10.3*↖ 10.1↙ 10.8*↖ 9.9↓
 10.4*↓ 10.3*↖ 10.3*↗ 10.8*↖ 10.6*↖

beste Teiler: 37.3 (29.), 48.3 (24.), 78.1 (30.)
Trefferkreis: 8.51 mm
Trefferlage: 0.35 mm links, 0.49 mm tief

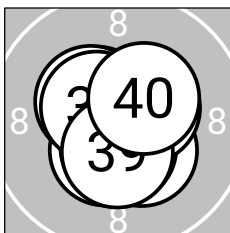

Serie 4: 104.6 (100)

10.4*↘ 10.5*↖ 10.5*↓ 10.5*↗ 10.4*↓
 10.4*↖ 10.5*↓ 10.5*↖ 10.5*↓ 10.4*↗

beste Teiler: 102.4 (37.), 106.4 (33.), 106.7 (38.)
Trefferkreis: 7.38 mm
Trefferlage: 0.04 mm links, 0.19 mm tief



LG 40 ZR

StandNr: 134

Penz, Florian #70819080

Senioren_1m

Wertung

StartNr: 173

01.03.2026 14:13

SG_Matrei_a._Br.

SG Matrei a. Br. 3

Ergebnis: **416.6** (397)
 Serien: 104.8 104.7 103.2 103.9
 Zähler: 37 3 0 0 0 0 0 0 0 0
 Innenzehner: 34
 Weitestе: 297 (28.), 266 (26.), 251 (38.)
 beste Teiler: 46.8 (12.), 47.3 (27.), 50.0 (13.)
 Trefferkreis: 10.13 mm
 Trefferlage: 0.25 mm rechts, 0.36 mm hoch

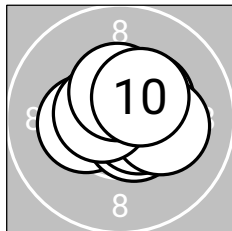
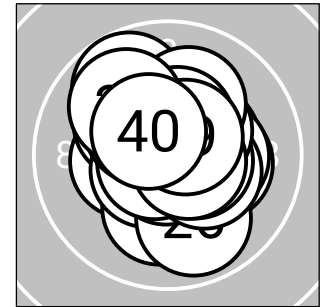
**Serie 1: 104.8** (100)

10.5*↗	10.4*↗	10.3*←	10.7*↖	10.6*↘
10.6*↘	10.2*↘	10.6*←	10.5*↑	10.4*↗

beste Teiler: 71.6 (4.), 87.6 (8.), 88.8 (6.)
 Trefferkreis: 7.95 mm
 Trefferlage: 0.31 mm rechts, 0.28 mm hoch

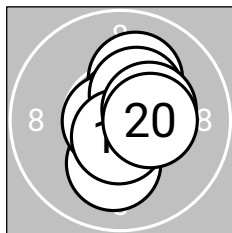
**Serie 2: 104.7** (100)

10.1↗	10.8*↑	10.8*↗	10.4*→	10.1↓
10.7*←	10.4*↗	10.6*↓	10.4*→	10.4*→

beste Teiler: 46.8 (12.), 50.0 (13.), 52.0 (16.)
 Trefferkreis: 8.63 mm
 Trefferlage: 0.51 mm rechts, 0.19 mm hoch

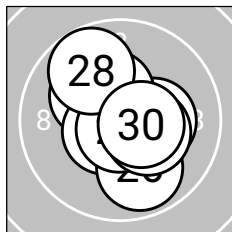
**Serie 3: 103.2** (98)

10.4*↘	10.2*↖	10.3*→	10.4*↖	10.6*↖
9.9↓	10.8*↓	9.8↖	10.3*→	10.5*→

beste Teiler: 47.3 (27.), 97.2 (25.), 111.4 (30.)
 Trefferkreis: 10.13 mm
 Trefferlage: 0.22 mm rechts, 0.01 mm hoch

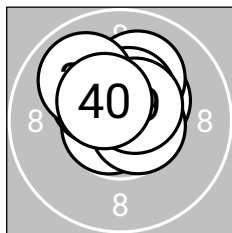
**Serie 4: 103.9** (99)

10.4*↑	10.7*↖	10.4*↗	10.1↗	10.3*↖
10.6*↘	10.4*↗	9.9↖	10.6*↗	10.5*↖

beste Teiler: 58.1 (32.), 85.7 (36.), 99.0 (39.)
 Trefferkreis: 7.77 mm
 Trefferlage: 0.02 mm links, 0.97 mm hoch

LG 40 ZR

StandNr: 135

Bachnetzer, Martin #70819201

Senioren_1m

Wertung

StartNr: 174

01.03.2026 14:01

SG_Mieming

SG Mieming 1

Ergebnis: **415.0** (397)
 Serien: 103.5 103.8 103.8 103.9
 Zähler: 37 3 0 0 0 0 0 0 0 0
 Innenzehner: 34
 Weitester: 302 (23.), 281 (21.), 272 (14.)
 beste Teiler: 40.1 (15.), 53.4 (30.), 54.5 (38.)
 Trefferkreis: 10.21 mm
 Trefferlage: 0.11 mm rechts, 0.09 mm hoch

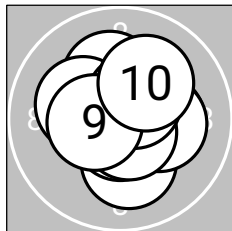
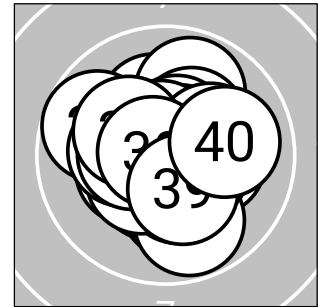
**Serie 1: 103.5** (100)

10.1 ↓ 10.7* ↓ 10.3* → 10.2* → 10.2* ↑
 10.7* ↓ 10.2* ← 10.5* ↗ 10.5* ← 10.1 ↗

beste Teiler: 65.0 (2.), 73.7 (6.), 107.2 (8.)
 Trefferkreis: 8.48 mm
 Trefferlage: 0.27 mm rechts, 0.13 mm hoch

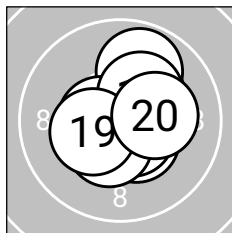
**Serie 2: 103.8** (99)

10.4* ↘ 10.6* ↘ 10.3* ↗ 9.9 ↑ 10.8* ←
 10.6* ← 10.4* ↓ 10.3* ↗ 10.3* ← 10.2* →

beste Teiler: 40.1 (15.), 88.5 (12.), 100.0 (16.)
 Trefferkreis: 8.56 mm
 Trefferlage: 0.30 mm rechts, 0.18 mm hoch

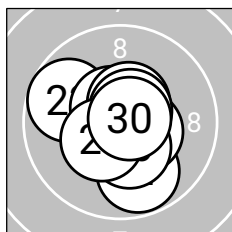
**Serie 3: 103.8** (98)

9.8 ↓ 10.6* ↘ 9.7 ← 10.6* ← 10.5* →
 10.4* ↓ 10.5* ↗ 10.6* ↗ 10.4* ← 10.7* →

beste Teiler: 53.4 (30.), 82.8 (28.), 91.0 (24.)
 Trefferkreis: 9.85 mm
 Trefferlage: 0.05 mm rechts, 0.23 mm tief

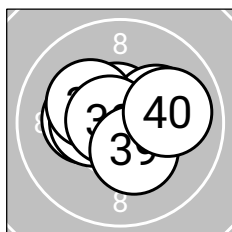
**Serie 4: 103.9** (100)

10.5* ← 10.7* ↑ 10.3* ← 10.6* ↑ 10.2* →
 10.4* ← 10.2* ← 10.7* ← 10.3* ↓ 10.0 →

beste Teiler: 54.5 (38.), 57.4 (32.), 81.4 (34.)
 Trefferkreis: 8.66 mm
 Trefferlage: 0.15 mm links, 0.27 mm hoch

Ergebnis: 409.1 (391)
Serien: 102.0 104.1 98.5 104.5
Zähler: 35 3 1 0 1 0 0 0 0 0 0
Innenzehner: 29
Weiteste: 1194 (29.), 533 (3.), 300 (19.)
beste Teiler: 11.0 (9.), 40.3 (37.), 42.0 (15.)
Trefferkreis: 18.79 mm
Trefferlage: 0.39 mm links, 0.01 mm hoch

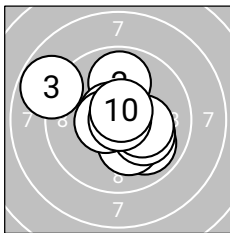
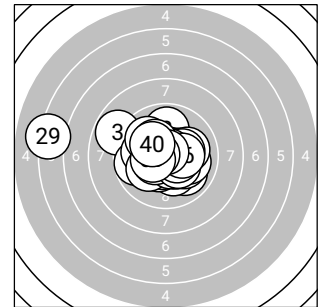

Serie 1: 102.0 (96)

9.9 ↘	9.9 ↑	8.8 ↙	10.2* ↘	10.7* ↙
10.1 ↘	10.2* →	10.6* ←	10.9* →	10.7* ↑

beste Teiler: 11.0 (9.), 69.2 (10.), 73.0 (5.)
Trefferkreis: 12.32 mm
Trefferlage: 0.03 mm rechts, 0.10 mm hoch

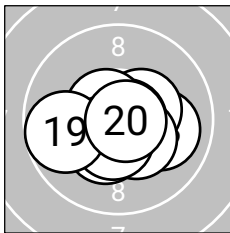

Serie 2: 104.1 (99)

10.4* ↙	10.4* ↘	10.0 →	10.4* →	10.8* →
10.6* ↙	10.4* ↘	10.5* ↘	9.8 ←	10.8* →

beste Teiler: 42.0 (15.), 42.2 (20.), 86.2 (16.)
Trefferkreis: 9.70 mm
Trefferlage: 0.03 mm links, 0.45 mm tief

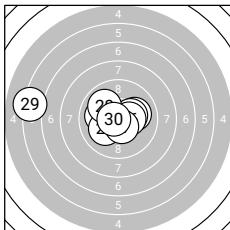

Serie 3: 98.5 (96)

10.1 →	10.2* ←	10.0 ←	10.3* →	10.1 ↙
10.4* →	10.5* ↘	10.0 ↙	6.2 ←	10.7* ←

beste Teiler: 60.0 (30.), 112.8 (27.), 143.0 (26.)
Trefferkreis: 18.50 mm
Trefferlage: 1.43 mm links, 0.29 mm hoch

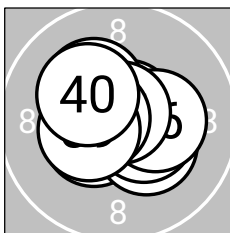

Serie 4: 104.5 (100)

10.5* ↙	10.7* ↗	10.3* ↘	10.5* →	10.2* ↙
10.3* →	10.8* ↑	10.6* ←	10.4* ←	10.2* ↙

beste Teiler: 40.3 (37.), 59.2 (32.), 86.3 (38.)
Trefferkreis: 7.88 mm
Trefferlage: 0.12 mm links, 0.12 mm hoch



Ergebnis: **413.8** (396)
 Serien: 104.6 103.0 104.0 102.2
 Zähler: 36 4 0 0 0 0 0 0 0 0
 Innenzehner: 31
 Weitestе: 415 (38.), 402 (11.), 375 (27.)
 beste Teiler: 51.0 (6.), 51.2 (37.), 54.1 (18.)
 Trefferkreis: 10.84 mm
 Trefferlage: 0.24 mm links, 0.26 mm hoch

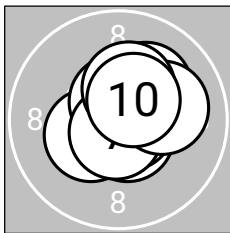
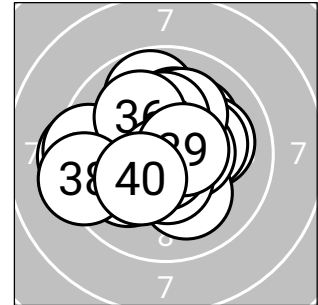

Serie 1: 104.6 (100)

10.4*↙	10.6*↘	10.2*↗	10.6*↗	10.5*↗
10.7*↘	10.7*↘	10.1→	10.3*↗	10.5*↗

beste Teiler: 51.0 (6.), 62.1 (7.), 85.2 (2.)
 Trefferkreis: 8.16 mm
 Trefferlage: 0.48 mm rechts, 0.39 mm hoch

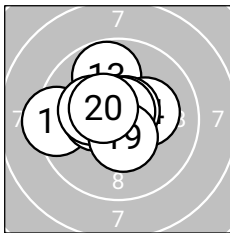

Serie 2: 103.0 (98)

9.3←	10.7*↗	9.8↑	10.2*→	10.7*↗
10.4*←	10.2*←	10.7*↑	10.5*↘	10.5*↖

beste Teiler: 54.1 (18.), 66.7 (12.), 71.2 (15.)
 Trefferkreis: 10.30 mm
 Trefferlage: 0.56 mm links, 0.49 mm hoch

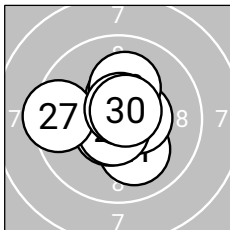

Serie 3: 104.0 (99)

10.1↘	10.6*↙	10.6*↗	10.5*→	10.7*↘
10.4*↑	9.5←	10.2*↑	10.7*↑	10.7*↗

beste Teiler: 65.3 (29.), 69.4 (30.), 72.4 (25.)
 Trefferkreis: 9.86 mm
 Trefferlage: 0.08 mm links, 0.23 mm hoch

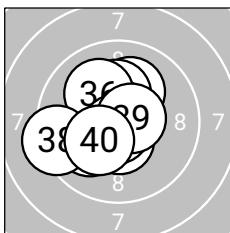

Serie 4: 102.2 (99)

10.5*↓	10.1↗	10.3*↙	10.1↙	10.2*↑
10.1↖	10.7*↘	9.3←	10.6*→	10.3*↙

beste Teiler: 51.2 (37.), 85.6 (39.), 115.2 (31.)
 Trefferkreis: 10.19 mm
 Trefferlage: 0.81 mm links, 0.07 mm tief



LG 40 ZR

StandNr: 138

Trenkwalder, Hermann #70819202

Senioren_1m

Wertung

StartNr: 177

01.03.2026 14:13

SG_Kundl

SG Kundl 1

Ergebnis: **417.8** (399)
 Serien: 103.7 105.5 105.1 103.5
 Zähler: 39 1 0 0 0 0 0 0 0 0
 Innenzehner: 33
 Weitester: 282 (10.), 245 (40.), 239 (1.)
 beste Teiler: 30.5 (6.), 32.5 (8.), 37.4 (18.)
 Trefferkreis: 9.73 mm
 Trefferlage: 0.07 mm links, 0.04 mm tief

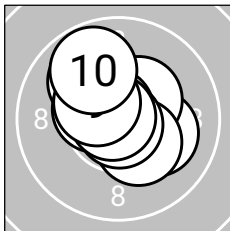
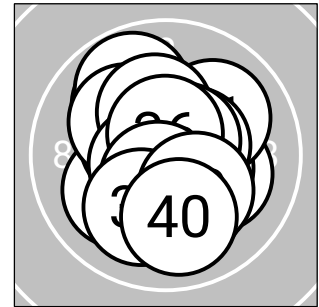

Serie 1: 103.7 (99)

10.0 ↗	10.1 ↘	10.4* ↗	10.3* ↘	10.4* ↖
10.8* ↓	10.7* ↖	10.8* ↖	10.4* ↖	9.8 ↘

beste Teiler: 30.5 (6.), 32.5 (8.), 57.2 (7.)
 Trefferkreis: 9.05 mm
 Trefferlage: 0.16 mm links, 0.50 mm hoch

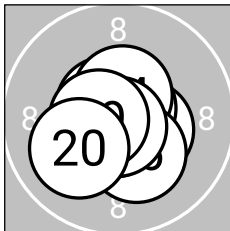

Serie 2: 105.5 (100)

10.6* ↖	10.4* ↘	10.7* ↗	10.5* ↑	10.7* ↘
10.3* ↘	10.8* ↘	10.8* ↓	10.6* ↖	10.1 ↖

beste Teiler: 37.4 (18.), 45.6 (17.), 58.4 (13.)
 Trefferkreis: 7.75 mm
 Trefferlage: 0.14 mm links, 0.27 mm tief

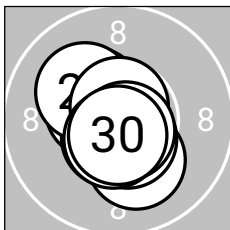

Serie 3: 105.1 (100)

10.5* ↖	10.6* ↘	10.2* ↘	10.3* ↖	10.2* ↖
10.7* ↑	10.6* ↘	10.6* ↓	10.7* ↘	10.7* ↓

beste Teiler: 59.9 (29.), 62.1 (26.), 69.0 (30.)
 Trefferkreis: 8.39 mm
 Trefferlage: 0.27 mm links, 0.20 mm tief

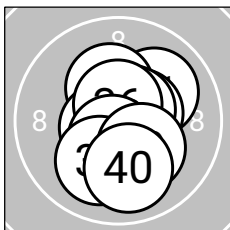

Serie 4: 103.5 (100)

10.0 ↗	10.5* ↗	10.3* ↑	10.6* ↗	10.6* ↖
10.6* ↑	10.6* ↘	10.1 ↘	10.2* ↘	10.0 ↓

beste Teiler: 81.9 (35.), 84.0 (36.), 85.7 (34.)
 Trefferkreis: 8.94 mm
 Trefferlage: 0.27 mm rechts, 0.21 mm tief



LG 40 ZR

StandNr: 139

Schatz, Christoph #70819200**Senioren_1m**

Wertung

StartNr: 178

01.03.2026 14:06

SG_Imst

SG Imst 1

Ergebnis: **413.1** (398)
 Serien: 103.3 104.5 103.2 102.1
 Zähler: 38 2 0 0 0 0 0 0 0 0
 Innenzehner: 29
 Weitest: 335 (34.), 261 (30.), 246 (1.)
 beste Teiler: 41.4 (22.), 48.6 (14.), 57.3 (6.)
 Trefferkreis: 9.86 mm
 Trefferlage: 0.21 mm links, 0.24 mm tief

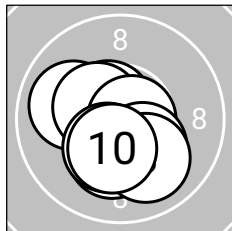
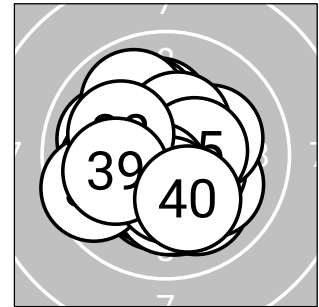
**Serie 1: 103.3** (100)

10.0 ← 10.6* ↓ 10.6* ↖ 10.4* ↖ 10.2* ↓
 10.7* → 10.2* ↘ 10.0 ↓ 10.3* ↘ 10.3* ↘

beste Teiler: 57.3 (6.), 86.1 (2.), 92.7 (3.)
 Trefferkreis: 9.01 mm
 Trefferlage: 0.23 mm links, 0.70 mm tief

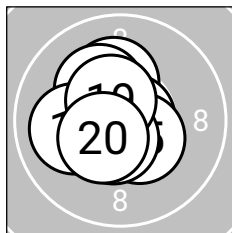
**Serie 2: 104.5** (100)

10.7* ← 10.2* ↑ 10.6* ↓ 10.8* → 10.4* ↘
 10.2* ↖ 10.0 ← 10.6* ↘ 10.5* ↖ 10.5* ↖

beste Teiler: 48.6 (14.), 65.1 (11.), 78.7 (13.)
 Trefferkreis: 8.09 mm
 Trefferlage: 0.46 mm links, 0.05 mm hoch

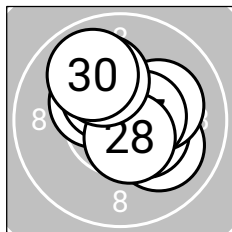
**Serie 3: 103.2** (99)

10.3* ↖ 10.8* → 10.0 ↘ 10.4* ↖ 10.4* ↘
 10.2* → 10.5* → 10.6* ↘ 10.1 ↖ 9.9 ↖

beste Teiler: 41.4 (22.), 97.5 (28.), 102.7 (27.)
 Trefferkreis: 9.26 mm
 Trefferlage: 0.26 mm rechts, 0.44 mm hoch

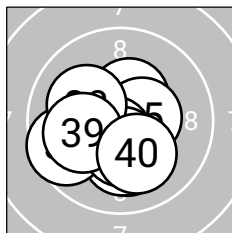
**Serie 4: 102.1** (99)

10.4* ↑ 10.1 ↓ 10.2* ↓ 9.6 ← 10.5* →
 10.6* ↓ 10.4* ↓ 10.1 ↖ 10.1 ← 10.1 ↓

beste Teiler: 96.1 (36.), 123.4 (35.), 137.4 (31.)
 Trefferkreis: 9.09 mm
 Trefferlage: 0.42 mm links, 0.78 mm tief

LG 40 ZR

StandNr: 140

Hörtnagl, Martin #70819282**Senioren_1m**

Wertung

StartNr: 179

01.03.2026 14:00

SG_Matrei_a._Br.

SG Matrei a. Br. 3

Ergebnis: **422.4** (400)
 Serien: 104.7 106.2 105.0 106.5
 Zähler: 40 0 0 0 0 0 0 0 0 0 0
 Innenzehner: 39
 Weitester: 228 (1.), 185 (4.), 170 (7.)
 beste Teiler: 12.0 (35.), 19.6 (5.), 21.9 (31.)
 Trefferkreis: 8.25 mm
 Trefferlage: 0.06 mm rechts, 0.14 mm hoch

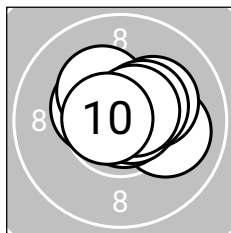
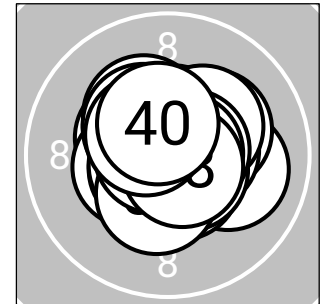
**Serie 1: 104.7** (100)

10.0➔	10.5*➔	10.4*↖	10.2*➔	10.9*➔
10.7*➔	10.3*↖	10.4*➔	10.6*➔	10.7*↖

beste Teiler: 19.6 (5.), 57.9 (6.), 64.9 (10.)
 Trefferkreis: 8.19 mm
 Trefferlage: 0.45 mm rechts, 0.44 mm hoch

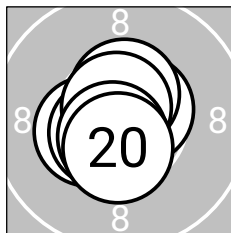
**Serie 2: 106.2** (100)

10.8*↓	10.6*➔	10.8*↖	10.6*↖	10.4*↖
10.5*↑	10.6*↖	10.7*↖	10.7*↖	10.5*↓

beste Teiler: 39.1 (11.), 49.4 (13.), 56.3 (18.)
 Trefferkreis: 6.78 mm
 Trefferlage: 0.26 mm links, 0.17 mm tief

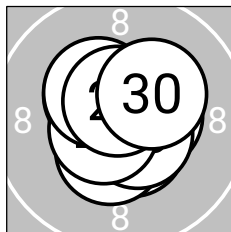
**Serie 3: 105.0** (100)

10.6*↘	10.4*↖	10.5*➔	10.6*➔	10.4*↘
10.6*↘	10.6*↖	10.4*↖	10.6*↑	10.3*➔

beste Teiler: 76.9 (27.), 78.7 (29.), 79.2 (24.)
 Trefferkreis: 7.42 mm
 Trefferlage: 0.10 mm rechts, 0.18 mm hoch

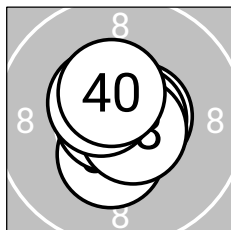
**Serie 4: 106.5** (100)

10.9*➔	10.4*↘	10.6*➔	10.7*➔	10.9*↖
10.8*↖	10.5*↖	10.7*➔	10.5*↖	10.5*↑

beste Teiler: 12.0 (35.), 21.9 (31.), 49.2 (36.)
 Trefferkreis: 7.08 mm
 Trefferlage: 0.05 mm links, 0.14 mm hoch

LG 40 ZR

StandNr: 141

Kilzer, Reinhard #70818497

Senioren_1m

Wertung

StartNr: 180

01.03.2026 14:11

SG_Lienz_SSV

Ergebnis: **422.0** (399)
 Serien: 105.2 105.0 106.0 105.8
 Zähler: 39 1 0 0 0 0 0 0 0 0
 Innenzehner: 37
 Weitestе: 259 (10.), 221 (16.), 220 (7.)
 beste Teiler: 7.2 (26.), 10.0 (37.), 23.2 (5.)
 Trefferkreis: 8.67 mm
 Trefferlage: 0.10 mm rechts, 0.00 mm

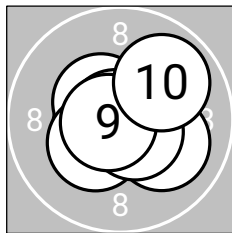
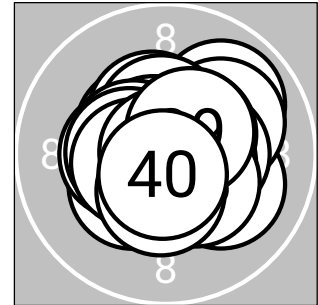

Serie 1: 105.2 (99)

10.6*←	10.5*↖	10.7*↘	10.9*←	10.9*↘
10.3*↙	10.1*→	10.6*↘	10.7*←	9.9*↗

beste Teiler: 23.2 (5.), 23.7 (4.), 56.5 (9.)
 Trefferkreis: 8.67 mm
 Trefferlage: 0.13 mm rechts, 0.11 mm tief

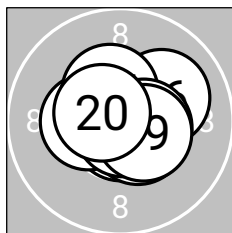

Serie 2: 105.0 (100)

10.7*↓	10.5*↘	10.4*←	10.5*↖	10.8*↘
10.1*↗	10.4*↖	10.5*→	10.5*→	10.6*↖

beste Teiler: 35.4 (15.), 52.0 (11.), 93.9 (20.)
 Trefferkreis: 8.08 mm
 Trefferlage: 0.16 mm rechts, 0.13 mm hoch

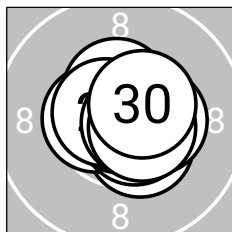

Serie 3: 106.0 (100)

10.5*↘	10.4*→	10.5*←	10.5*↑	10.7*↘
10.9*↗	10.7*↖	10.7*→	10.6*→	10.5*↗

beste Teiler: 7.2 (26.), 61.5 (28.), 70.8 (27.)
 Trefferkreis: 6.92 mm
 Trefferlage: 0.34 mm rechts, 0.07 mm hoch

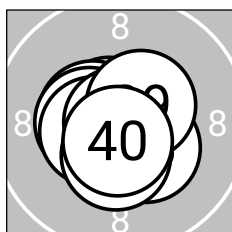

Serie 4: 105.8 (100)

10.8*↑	10.7*↖	10.5*←	10.4*←	10.5*←
10.4*↘	10.9*↖	10.4*↓	10.5*↗	10.7*↓

beste Teiler: 10.0 (37.), 36.0 (31.), 65.1 (32.)
 Trefferkreis: 7.09 mm
 Trefferlage: 0.23 mm links, 0.12 mm tief



Ergebnis: 394.7 (379)
Serien: 98.4 98.3 99.8 98.2
Zähler: 22 15 3 0 0 0 0 0 0 0
Innenzehner: 18
Weiteste: 569 (16.), 565 (27.), 560 (32.)
beste Teiler: 84.6 (29.), 90.7 (21.), 92.2 (22.)
Trefferkreis: 14.93 mm
Trefferlage: 1.42 mm links, 0.37 mm hoch

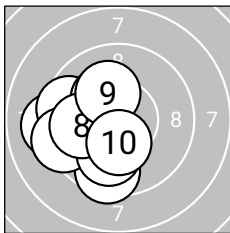
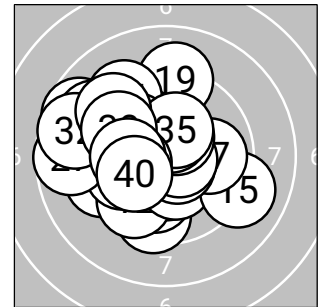

Serie 1: 98.4 (95)

9.2←	10.2*←	9.5↓	9.6←	9.3←
10.0↓	10.2*↖	9.9←	10.2*↖	10.3*↓

beste Teiler: 158.0 (10.), 179.0 (7.), 195.7 (9.)
Trefferkreis: 10.18 mm
Trefferlage: 1.89 mm links, 0.66 mm tief

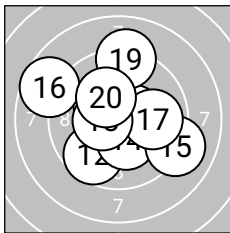

Serie 2: 98.3 (94)

10.3*↖	9.7↙	10.5*→	10.3*↓	9.1↘
8.7←	9.9→	10.5*←	9.1↑	10.2*↖

beste Teiler: 114.7 (13.), 119.2 (18.), 164.9 (14.)
Trefferkreis: 14.93 mm
Trefferlage: 0.11 mm links, 0.39 mm hoch

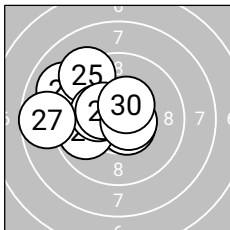

Serie 3: 99.8 (95)

10.6*↘	10.6*↑	9.9←	9.0←	9.3↖
10.3*←	8.7←	10.4*←	10.6*→	10.4*↗

beste Teiler: 84.6 (29.), 90.7 (21.), 92.2 (22.)
Trefferkreis: 11.01 mm
Trefferlage: 1.54 mm links, 0.70 mm hoch

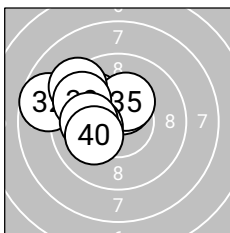

Serie 4: 98.2 (95)

9.5↖	8.7←	10.0↖	10.4*↑	10.3*↗
10.2*←	9.3↖	9.7←	10.0←	10.1←

beste Teiler: 129.7 (34.), 164.5 (35.), 194.5 (36.)
Trefferkreis: 10.48 mm
Trefferlage: 2.13 mm links, 1.05 mm hoch



LG 40 ZR

StandNr: 143

Wachtler, Hubert #70818144

Senioren_1m

Wertung

StartNr: 182

01.03.2026 14:08

SG_Fügenberg

SG Fügenberg 1

Ergebnis: **417.7 (398)**
 Serien: 103.3 104.2 104.8 105.4
 Zähler: 38 2 0 0 0 0 0 0 0 0
 Innenzehner: 32
 Weitest: 282 (13.), 261 (2.), 248 (10.)
 beste Teiler: 28.1 (40.), 32.5 (5.), 37.1 (38.)
 Trefferkreis: 9.73 mm
 Trefferlage: 0.04 mm links, 0.07 mm hoch

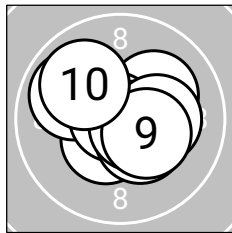
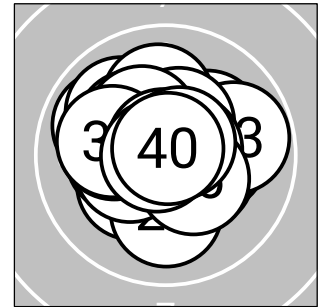
**Serie 1: 103.3 (99)**

10.5*↙	9.9↖	10.4*↗	10.1↗	10.8*↖
10.4*↘	10.6*↗	10.2*↗	10.4*↗	10.0↖

beste Teiler: 32.5 (5.), 76.9 (7.), 124.6 (1.)
 Trefferkreis: 8.84 mm
 Trefferlage: 0.26 mm rechts, 0.05 mm hoch

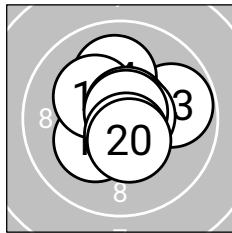
**Serie 2: 104.2 (99)**

10.2*↙	10.7*↗	9.8↗	10.1↑	10.2*↖
10.7*↗	10.7*↗	10.8*↗	10.6*↘	10.4*↘

beste Teiler: 46.0 (18.), 58.0 (12.), 62.6 (16.)
 Trefferkreis: 9.05 mm
 Trefferlage: 0.22 mm rechts, 0.23 mm hoch

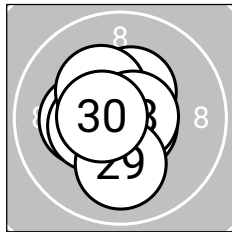
**Serie 3: 104.8 (100)**

10.7*↘	10.6*↖	10.2*←	10.4*←	10.8*↗
10.4*↗	10.3*↖	10.7*↗	10.1↓	10.6*←

beste Teiler: 44.8 (25.), 63.5 (28.), 67.4 (21.)
 Trefferkreis: 8.25 mm
 Trefferlage: 0.37 mm links, 0.03 mm tief

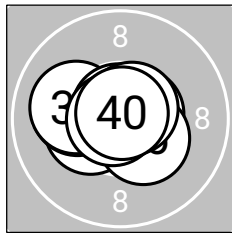
**Serie 4: 105.4 (100)**

10.7*↘	10.6*↗	10.4*←	10.1←	10.1←
10.4*↘	10.8*↑	10.8*←	10.7*↗	10.8*↗

beste Teiler: 28.1 (40.), 37.1 (38.), 43.4 (37.)
 Trefferkreis: 8.10 mm
 Trefferlage: 0.30 mm links, 0.06 mm hoch

LG 40 ZR

StandNr: 144

Rizzi, Harald #70819283

Senioren_1m

Wertung

StartNr: 183

01.03.2026 14:03

SG_Imst

SG Imst 3

Ergebnis: **402.5** (385)
 Serien: 100.8 101.8 99.7 100.2
 Zähler: 25 15 0 0 0 0 0 0 0 0
 Innenzehner: 16
 Weitester: 442 (1.), 439 (26.), 432 (11.)
 beste Teiler: 22.8 (20.), 47.0 (38.), 66.1 (37.)
 Trefferkreis: 12.00 mm
 Trefferlage: 0.45 mm links, 0.63 mm hoch

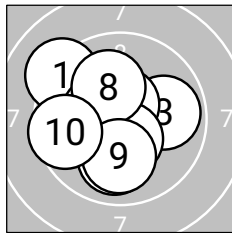
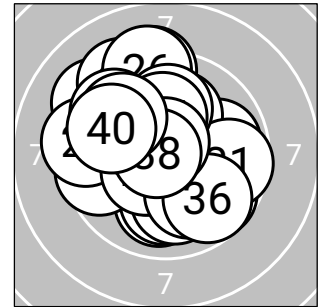
**Serie 1: 100.8** (97)

9.2↖	10.6*↖	9.9→	10.4*↖	10.6*↑
10.4*↓	10.0↓	10.1↑	10.0↓	9.6↖

beste Teiler: 79.1 (2.), 87.8 (5.), 126.9 (6.)
 Trefferkreis: 11.18 mm
 Trefferlage: 0.69 mm links, 0.08 mm tief

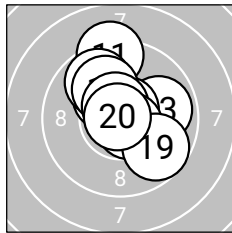
**Serie 2: 101.8** (96)

9.2↑	10.3*↖	9.9→	10.7*↑	9.8↖
10.1↑	10.6*↖	10.6*↘	9.7↘	10.9*↖

beste Teiler: 22.8 (20.), 68.0 (14.), 78.2 (18.)
 Trefferkreis: 11.41 mm
 Trefferlage: 0.12 mm rechts, 0.98 mm hoch

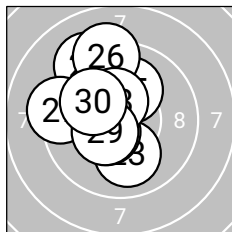
**Serie 3: 99.7** (97)

10.5*↖	9.2↖	10.0↓	10.5*↖	10.1↑
9.2↑	9.3↖	10.4*↑	10.4*↖	10.1↖

beste Teiler: 115.8 (21.), 118.3 (24.), 129.8 (29.)
 Trefferkreis: 11.26 mm
 Trefferlage: 1.08 mm links, 1.03 mm hoch

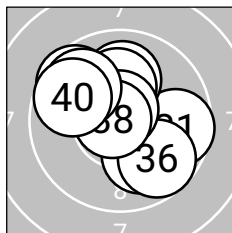
**Serie 4: 100.2** (95)

9.7→	10.0↑	9.6↖	10.0↘	10.2*↑
9.7↘	10.7*↑	10.8*↖	9.8↖	9.7↖

beste Teiler: 47.0 (38.), 66.1 (37.), 194.6 (35.)
 Trefferkreis: 10.94 mm
 Trefferlage: 0.16 mm links, 0.58 mm hoch

LG 40 ZR

StandNr: 145

Leitner, Martin #70819284

Senioren_1m

Wertung

StartNr: 184

01.03.2026 14:03

SG_Haiming

SG Haiming 1

Ergebnis: **405.2** (388)
 Serien: 100.7 100.0 101.2 103.3
 Zähler: 29 10 1 0 0 0 0 0 0 0
 Innezzehner: 21
 Weitest: 538 (17.), 442 (16.), 441 (2.)
 beste Teiler: 46.3 (29.), 61.4 (31.), 62.1 (36.)
 Trefferkreis: 13.32 mm
 Trefferlage: 0.59 mm rechts, 0.75 mm tief

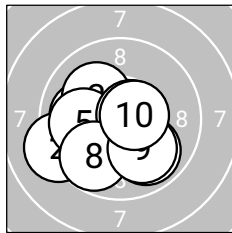
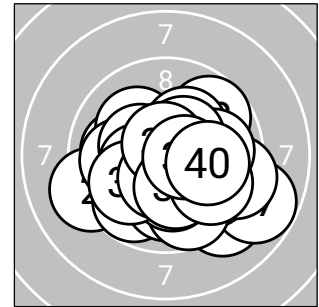
**Serie 1: 100.7** (97)

10.0 ← 9.2 ← 10.1 ↗ 10.4* ↘ 10.0 ←
 9.9 ↘ 10.7* → 9.8 ↘ 10.0 ↘ 10.6* →

beste Teiler: 74.0 (7.), 93.8 (10.), 150.7 (4.)
 Trefferkreis: 10.28 mm
 Trefferlage: 0.66 mm links, 0.77 mm tief

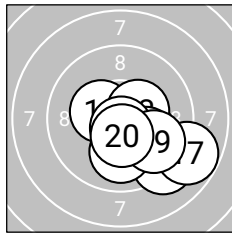
**Serie 2: 100.0** (96)

10.4* ← 10.2* ↘ 10.4* → 10.0 ↘ 10.7* ↓
 9.2 ↘ 8.8 ↘ 10.0 ↓ 9.8 ↘ 10.5* ↓

beste Teiler: 67.3 (15.), 123.5 (20.), 136.6 (13.)
 Trefferkreis: 11.34 mm
 Trefferlage: 1.38 mm rechts, 1.28 mm tief

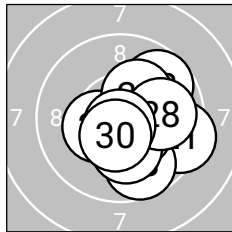
**Serie 3: 101.2** (96)

9.4 → 9.7 ↗ 9.7 ↘ 10.4* ← 10.4* ↘
 10.2* ↗ 10.2* ↓ 9.9 → 10.8* ↓ 10.5* ↓

beste Teiler: 46.3 (29.), 113.3 (30.), 130.0 (25.)
 Trefferkreis: 9.75 mm
 Trefferlage: 1.04 mm rechts, 0.50 mm tief

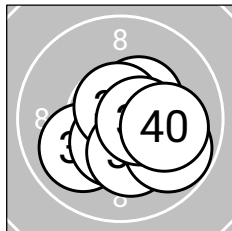
**Serie 4: 103.3** (99)

10.7* ↗ 10.0 ← 10.5* → 10.5* ↓ 10.4* ↗
 10.7* ↗ 10.2* ↓ 9.8 ↘ 10.5* → 10.0 →

beste Teiler: 61.4 (31.), 62.1 (36.), 101.5 (39.)
 Trefferkreis: 8.88 mm
 Trefferlage: 0.61 mm rechts, 0.45 mm tief

LG 40 ZR

StandNr: 146

Scheiber, Norbert #70819285**Senioren_1m**

Wertung

StartNr: 185

01.03.2026 14:11

SG_Fulpmes

Ergebnis: **416.8** (397)
 Serien: 103.6 105.2 104.3 103.7
 Zähler: 37 3 0 0 0 0 0 0 0 0
 Innenzehner: 33
 Weitestе: 309 (39.), 300 (22.), 261 (31.)
 beste Teiler: 8.9 (16.), 11.4 (27.), 17.6 (32.)
 Trefferkreis: 9.69 mm
 Trefferlage: 0.56 mm rechts, 0.22 mm hoch

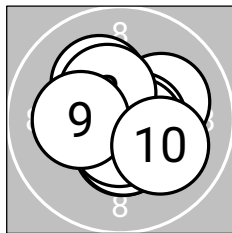
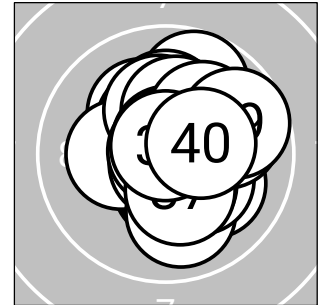
**Serie 1: 103.6** (100)

10.1 ↗ 10.6* ↗ 10.4* ↓ 10.6* ↗ 10.2* ↖
 10.4* ↓ 10.6* ↓ 10.4* ↖ 10.2* ← 10.1 ↗

beste Teiler: 76.6 (4.), 83.1 (2.), 85.1 (7.)
 Trefferkreis: 8.57 mm
 Trefferlage: 0.20 mm rechts, 0.11 mm tief

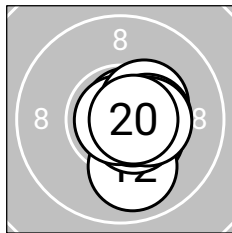
**Serie 2: 105.2** (100)

10.4* ↘ 10.0 ↓ 10.6* ↘ 10.7* ↗ 10.7* ↗
 10.9* ↖ 10.4* ↗ 10.4* ↗ 10.4* ↗ 10.7* ↗

beste Teiler: 8.9 (16.), 51.6 (14.), 64.9 (15.)
 Trefferkreis: 7.69 mm
 Trefferlage: 0.78 mm rechts, 0.28 mm tief

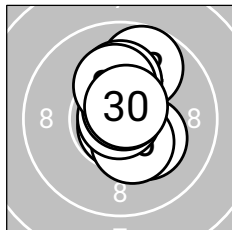
**Serie 3: 104.3** (99)

10.3* ↑ 9.8 ↗ 10.3* ↘ 10.8* ↓ 10.2* ↑
 10.4* ↘ 10.9* ↖ 10.7* ↑ 10.2* ↑ 10.7* ↗

beste Teiler: 11.4 (27.), 40.6 (24.), 60.0 (28.)
 Trefferkreis: 8.55 mm
 Trefferlage: 0.31 mm rechts, 0.69 mm hoch

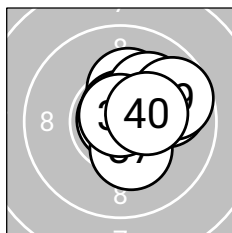
**Serie 4: 103.7** (98)

9.9 ↗ 10.9* ↖ 10.2* ↑ 10.7* ↑ 10.7* ↗
 10.1 ↗ 10.3* ↓ 10.8* ↑ 9.7 ↗ 10.4* ↗

beste Teiler: 17.6 (32.), 34.0 (38.), 53.2 (34.)
 Trefferkreis: 8.15 mm
 Trefferlage: 0.95 mm rechts, 0.59 mm hoch

LG 40 ZR

StandNr: 101

Egger, Mario #70819286

Senioren_1m

Wertung

StartNr: 186

01.03.2026 15:31

SG_Kirchbichl

SG Kirchbichl 1

Ergebnis: **415.3** (394)
 Serien: 103.6 104.9 102.1 104.7
 Zähler: 34 6 0 0 0 0 0 0 0 0
 Innenzehner: 30
 Weitester: 321 (25.), 291 (28.), 275 (37.)
 beste Teiler: 6.0 (38.), 37.3 (33.), 37.8 (32.)
 Trefferkreis: 10.33 mm
 Trefferlage: 0.02 mm links, 0.00 mm

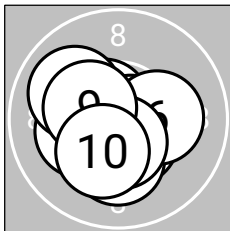
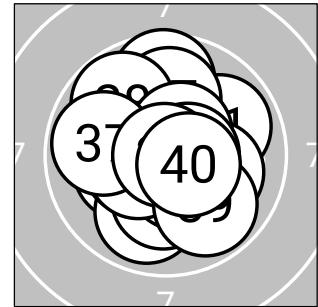

Serie 1: 103.6 (100)

10.6*↖	10.2*↖	10.5*↘	10.2*↓	10.7*→
10.2*→	10.0↖	10.5*↓	10.4*↖	10.3*↘

beste Teiler: 60.8 (5.), 94.9 (1.), 112.4 (8.)
 Trefferkreis: 8.72 mm
 Trefferlage: 0.35 mm links, 0.38 mm tief

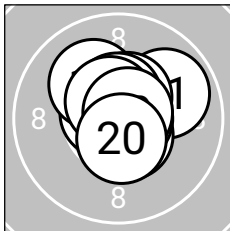

Serie 2: 104.9 (99)

9.9↗	10.7*↖	10.1↖	10.5*↗	10.6*↘
10.5*↑	10.8*→	10.6*↖	10.7*↗	10.5*↓

beste Teiler: 48.0 (17.), 55.7 (19.), 73.5 (12.)
 Trefferkreis: 8.31 mm
 Trefferlage: 0.19 mm rechts, 0.46 mm hoch

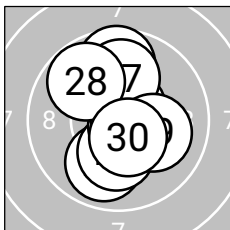

Serie 3: 102.1 (97)

10.6*↘	9.9↓	10.2*↓	10.7*↘	9.7↑
10.6*↗	10.0↑	9.8↖	10.1→	10.5*↘

beste Teiler: 59.9 (24.), 77.3 (21.), 83.4 (26.)
 Trefferkreis: 10.21 mm
 Trefferlage: 0.13 mm rechts, 0.16 mm hoch

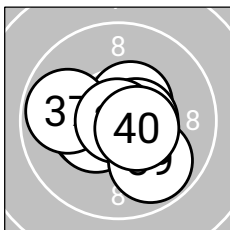

Serie 4: 104.7 (98)

10.5*↗	10.8*↘	10.8*↓	10.6*→	10.4*↖
10.4*↖	9.9↖	10.9*↖	9.9↘	10.5*↘

beste Teiler: 6.0 (38.), 37.3 (33.), 37.8 (32.)
 Trefferkreis: 9.66 mm
 Trefferlage: 0.07 mm links, 0.25 mm tief



Ergebnis: 408.5 (392)
Serien: 102.8 101.6 103.1 101.0
Zähler: 32 8 0 0 0 0 0 0 0 0
Innenzehner: 23
Weiteste: 442 (4.), 424 (13.), 339 (36.)
beste Teiler: 8.5 (2.), 36.7 (3.), 49.6 (20.)
Trefferkreis: 12.15 mm
Trefferlage: 0.56 mm links, 0.11 mm hoch

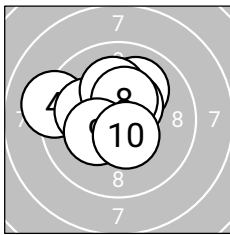
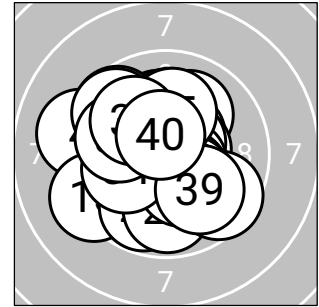

Serie 1: 102.8 (99)

10.0 ↗	10.9* ↖	10.8* ↗	9.2 ↖	10.1 ↖
10.1 ↑	10.5* ↗	10.4* ↑	10.3* ↖	10.5* ↘

beste Teiler: 8.5 (2.), 36.7 (3.), 117.6 (10.)
Trefferkreis: 10.17 mm
Trefferlage: 0.51 mm links, 0.63 mm hoch

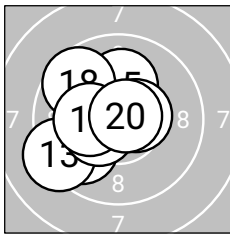

Serie 2: 101.6 (97)

10.5* ↖	9.8 ↖	9.3 ↖	10.4* ↖	10.1 ↑
10.5* →	10.3* ↖	9.6 ↖	10.3* ↖	10.8* ↗

beste Teiler: 49.6 (20.), 101.7 (11.), 109.4 (16.)
Trefferkreis: 10.24 mm
Trefferlage: 1.15 mm links, 0.15 mm hoch

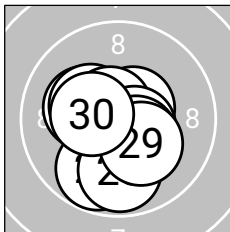

Serie 3: 103.1 (98)

10.2* ↖	10.6* ↗	10.3* ↖	10.7* ↖	9.8 ↘
10.6* ↘	10.4* ↘	9.9 ↓	10.2* ↘	10.4* ↖

beste Teiler: 72.0 (24.), 97.4 (22.), 98.4 (26.)
Trefferkreis: 8.42 mm
Trefferlage: 0.23 mm links, 0.54 mm tief

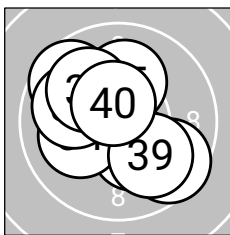

Serie 4: 101.0 (98)

10.3* ↘	10.7* ↖	9.6 ↖	10.1 ↖	10.1 ↑
9.6 ↘	10.0 ↖	10.0 ↖	10.0 ↘	10.6* ↑

beste Teiler: 61.6 (32.), 100.6 (40.), 163.4 (31.)
Trefferkreis: 11.17 mm
Trefferlage: 0.36 mm links, 0.20 mm hoch



LG 40 ZR

StandNr: 103

Manzl, Robert #70819287

Senioren_1m

Wertung

StartNr: 188

01.03.2026 15:40

SG_Kirchbichl

SG Kirchbichl 1

Ergebnis: **416.4** (398)
 Serien: 104.6 104.4 103.0 104.4
 Zähler: 38 2 0 0 0 0 0 0 0 0 0
 Innenzehner: 32
 Weitest: 348 (23.), 279 (27.), 245 (39.)
 beste Teiler: 37.6 (3.), 47.4 (30.), 54.6 (17.)
 Trefferkreis: 10.58 mm
 Trefferlage: 0.30 mm rechts, 0.19 mm tief

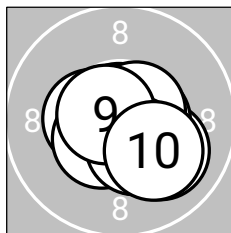
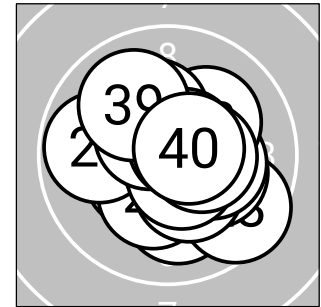
**Serie 1: 104.6** (100)

10.4*↘	10.4*←	10.8*↑	10.1↘	10.5*↙
10.6*→	10.6*↗	10.4*↘	10.7*←	10.1↘

beste Teiler: 37.6 (3.), 71.1 (9.), 84.3 (7.)
 Trefferkreis: 7.92 mm
 Trefferlage: 0.35 mm rechts, 0.45 mm tief

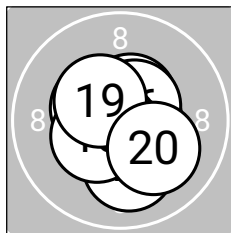
**Serie 2: 104.4** (100)

10.5*↓	10.4*↖	10.5*↗	10.1↓	10.7*→
10.6*↗	10.7*↙	10.4*↖	10.4*↖	10.1↘

beste Teiler: 54.6 (17.), 75.1 (15.), 98.2 (16.)
 Trefferkreis: 8.03 mm
 Trefferlage: 0.03 mm rechts, 0.26 mm tief

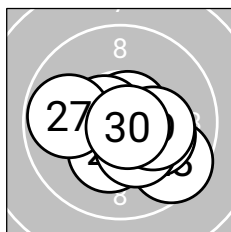
**Serie 3: 103.0** (98)

10.7*↗	10.6*←	9.6↘	10.5*↘	10.2*↗
10.3*↓	9.8←	10.3*↘	10.2*→	10.8*↘

beste Teiler: 47.4 (30.), 64.0 (21.), 90.1 (22.)
 Trefferkreis: 10.55 mm
 Trefferlage: 0.46 mm rechts, 0.60 mm tief

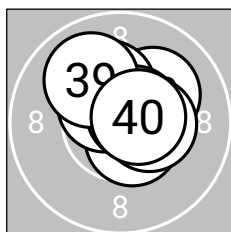
**Serie 4: 104.4** (100)

10.7*↗	10.6*↘	10.1↗	10.3*↖	10.6*↘
10.5*↖	10.6*↗	10.4*→	10.0↖	10.6*→

beste Teiler: 56.8 (31.), 78.8 (37.), 90.1 (40.)
 Trefferkreis: 7.98 mm
 Trefferlage: 0.35 mm rechts, 0.55 mm hoch

LG 40 ZR

StandNr: 104

Rainer, Gerold #70819206

Senioren_1m

Wertung

StartNr: 189

01.03.2026 15:46

SG_Imst

SG Imst 3

Ergebnis: **410.9** (394)
 Serien: 104.2 101.5 102.4 102.8
 Zähler: 34 6 0 0 0 0 0 0 0 0 0
 Innenzehner: 24
 Weitester: 373 (28.), 301 (18.), 291 (16.)
 beste Teiler: 30.8 (26.), 35.4 (21.), 42.9 (6.)
 Trefferkreis: 11.13 mm
 Trefferlage: 0.38 mm rechts, 0.19 mm hoch

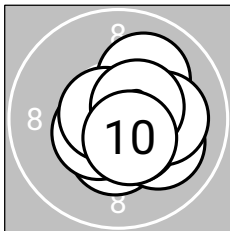
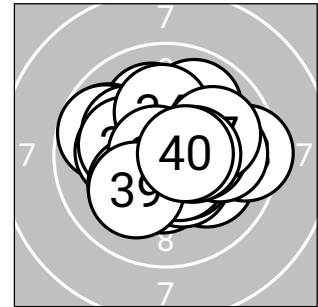

Serie 1: 104.2 (100)

10.1 ↗	10.4* ↓	10.1 ↘	10.5* ↘	10.5* ↙
10.8* ↘	10.1 →	10.7* ↙	10.5* ↗	10.5* ↘

beste Teiler: 42.9 (6.), 64.8 (8.), 106.3 (10.)
 Trefferkreis: 8.09 mm
 Trefferlage: 0.60 mm rechts, 0.24 mm tief

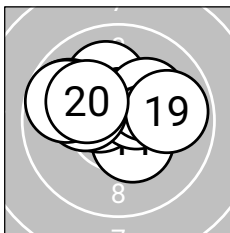

Serie 2: 101.5 (97)

10.4* ↘	10.1 ↗	10.5* ↙	10.5* ↗	10.2* ↗
9.8 ↙	10.2* ↙	9.7 ↙	9.9 →	10.2* ↙

beste Teiler: 115.3 (13.), 119.8 (14.), 136.4 (11.)
 Trefferkreis: 10.01 mm
 Trefferlage: 0.48 mm links, 0.75 mm hoch

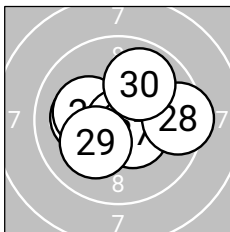

Serie 3: 102.4 (98)

10.8* ↗	10.3* →	10.1 ←	10.1 →	10.2* ↙
10.8* ↘	10.5* ↘	9.5 →	10.2* ↙	9.9 ↗

beste Teiler: 30.8 (26.), 35.4 (21.), 117.9 (27.)
 Trefferkreis: 10.24 mm
 Trefferlage: 0.49 mm rechts, 0.11 mm hoch

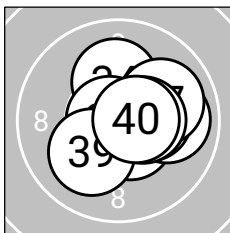

Serie 4: 102.8 (99)

10.1 →	10.5* ↘	9.9 →	10.1 ↑	10.8* ↙
10.3* →	10.0 →	10.4* →	10.1 ↙	10.6* →

beste Teiler: 46.3 (35.), 92.2 (40.), 102.8 (32.)
 Trefferkreis: 8.97 mm
 Trefferlage: 0.92 mm rechts, 0.16 mm hoch



LG 40 ZR

StandNr: 105

Hanser, Hannes #70819203

Senioren_1m

Wertung

StartNr: 190

01.03.2026 15:36

SG_Aschau

SG Aschau 1

Ergebnis: **418.2** (398)
 Serien: 105.3 104.5 103.7 104.7
 Zähler: 38 2 0 0 0 0 0 0 0 0
 Innenzehner: 36
 Weitester: 276 (27.), 255 (19.), 241 (38.)
 beste Teiler: 29.6 (35.), 44.5 (8.), 44.8 (32.)
 Trefferkreis: 9.68 mm
 Trefferlage: 0.05 mm rechts, 0.12 mm tief

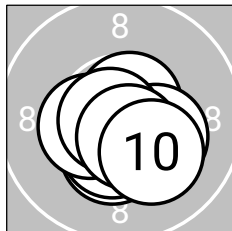
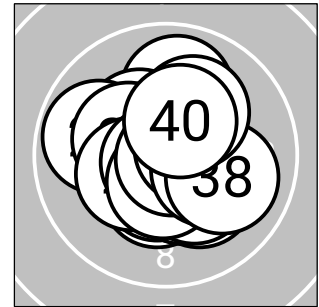
**Serie 1: 105.3** (100)

10.7*↗	10.3*↘	10.7*↓	10.4*↓	10.7*↓
10.5*↓	10.4*←	10.8*←	10.6*↘	10.2*↘

beste Teiler: 44.5 (8.), 57.7 (3.), 66.1 (5.)
 Trefferkreis: 7.39 mm
 Trefferlage: 0.10 mm rechts, 0.65 mm tief

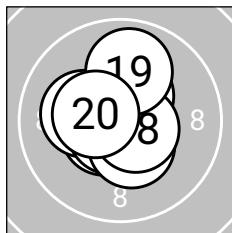
**Serie 2: 104.5** (99)

10.8*↙	10.4*↗	10.5*↙	10.6*←	10.2*←
10.7*↙	10.4*↘	10.6*↘	9.9↑	10.4*←

beste Teiler: 48.8 (11.), 72.1 (16.), 91.3 (18.)
 Trefferkreis: 8.39 mm
 Trefferlage: 0.33 mm links, 0.13 mm hoch

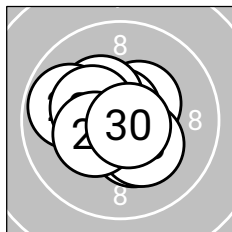
**Serie 3: 103.7** (99)

10.4*↗	10.7*↑	10.4*↘	10.5*↘	10.3*↘
10.3*↖	9.8←	10.3*←	10.3*←	10.7*↘

beste Teiler: 51.8 (30.), 52.9 (22.), 102.0 (24.)
 Trefferkreis: 8.81 mm
 Trefferlage: 0.28 mm links, 0.04 mm tief

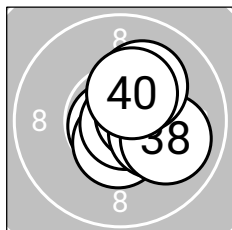
**Serie 4: 104.7** (100)

10.6*↗	10.8*↙	10.7*↘	10.5*↓	10.8*↘
10.5*↗	10.3*↘	10.0↔	10.1↗	10.4*↗

beste Teiler: 29.6 (35.), 44.8 (32.), 68.6 (33.)
 Trefferkreis: 7.71 mm
 Trefferlage: 0.74 mm rechts, 0.06 mm hoch

LG 40 ZR

StandNr: 106

Bliem, Peter #70819288

Senioren_1m

Wertung

StartNr: 191

01.03.2026 15:29

SG_Fügenberg

SG Fügenberg 1

Ergebnis: **417.9** (397)
 Serien: 104.3 105.5 104.5 103.6
 Zähler: 37 3 0 0 0 0 0 0 0 0
 Innenzehner: 34
 Weitester: 320 (34.), 267 (1.), 254 (8.)
 beste Teiler: 38.4 (7.), 39.2 (11.), 42.2 (33.)
 Trefferkreis: 10.30 mm
 Trefferlage: 0.18 mm rechts, 0.13 mm tief

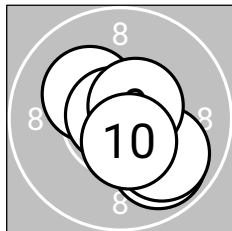
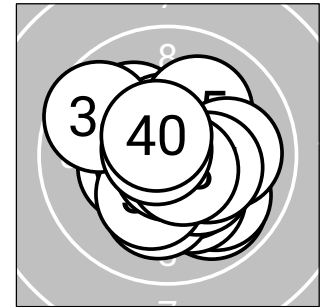
**Serie 1: 104.3** (98)

9.9 ↘	10.4* ↘	10.7* ↘	10.7* ↗	10.6* ↘
10.2* ↖	10.8* ↖	9.9 ↘	10.6* ↗	10.5* ↘

beste Teiler: 38.4 (7.), 70.9 (3.), 72.1 (4.)
 Trefferkreis: 9.02 mm
 Trefferlage: 0.58 mm rechts, 0.42 mm tief

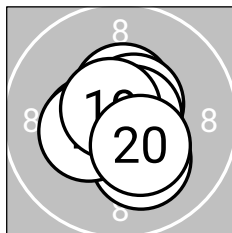
**Serie 2: 105.5** (100)

10.8* ←	10.8* ↘	10.5* ↑	10.6* ↗	10.7* ↗
10.4* ←	10.2* ↘	10.4* ←	10.7* ↖	10.4* ↘

beste Teiler: 39.2 (11.), 45.7 (12.), 56.0 (15.)
 Trefferkreis: 7.65 mm
 Trefferlage: 0.00 mm , 0.11 mm tief

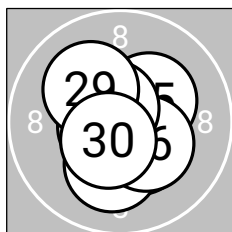
**Serie 3: 104.5** (100)

10.4* ↘	10.2* ↓	10.7* ↓	10.7* ↑	10.3* ↗
10.3* ↘	10.7* ←	10.6* ↖	10.1 ↖	10.5* ↘

beste Teiler: 54.1 (24.), 69.5 (23.), 73.0 (27.)
 Trefferkreis: 8.37 mm
 Trefferlage: 0.00 mm , 0.21 mm tief

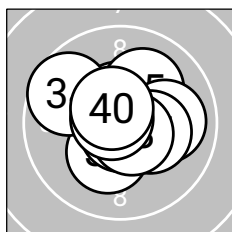
**Serie 4: 103.6** (99)

10.3* ↘	10.5* ↑	10.8* ↓	9.7 ↖	10.1 ↗
10.0 →	10.3* ↘	10.6* ↘	10.7* ↖	10.6* ↖

beste Teiler: 42.2 (33.), 51.8 (39.), 87.0 (38.)
 Trefferkreis: 9.92 mm
 Trefferlage: 0.13 mm rechts, 0.24 mm hoch

LG 40 ZR

StandNr: 107

Wimmer, Martin #70819208

Senioren_1m

Wertung

StartNr: 192

01.03.2026 15:35

SG_Fieberbrunn

SG Fieberbrunn 1

Ergebnis: **403.8** (383)
 Serien: 100.3 102.1 101.5 99.9
 Zähler: 25 13 2 0 0 0 0 0 0 0
 Innenzehner: 22
 Weitester: 676 (15.), 506 (40.), 462 (37.)
 beste Teiler: 31.0 (34.), 34.8 (17.), 57.2 (7.)
 Trefferkreis: 15.72 mm
 Trefferlage: 0.63 mm links, 0.02 mm tief

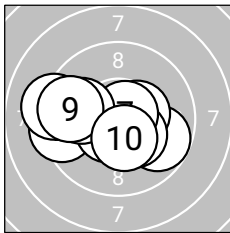
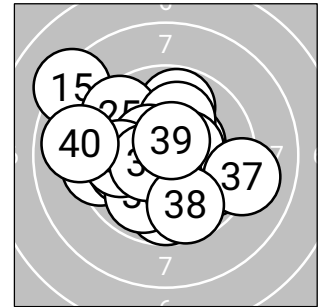
**Serie 1: 100.3** (95)

9.8↘	9.4↙	10.4*↗	9.2↙	10.3*↘
10.6*↙	10.7*↗	9.9↙	9.6↙	10.4*↘

beste Teiler: 57.2 (7.), 100.4 (6.), 132.9 (3.)
 Trefferkreis: 11.87 mm
 Trefferlage: 0.87 mm links, 0.23 mm tief

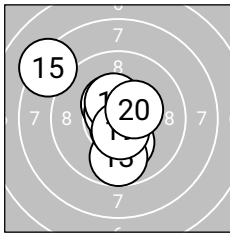
**Serie 2: 102.1** (97)

10.4*↖	10.2*↘	9.7↓	10.7*↓	8.2↖
10.7*↖	10.8*↗	10.4*↖	10.6*↓	10.4*↗

beste Teiler: 34.8 (17.), 61.6 (16.), 71.1 (14.)
 Trefferkreis: 13.37 mm
 Trefferlage: 0.47 mm links, 0.13 mm hoch

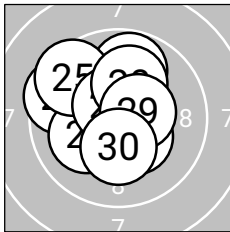
**Serie 3: 101.5** (97)

9.8↑	9.5↙	10.1↙	10.4*↘	9.5↖
10.7*↗	10.6*↖	10.1↑	10.5*↗	10.3*↓

beste Teiler: 65.0 (26.), 90.2 (27.), 121.1 (29.)
 Trefferkreis: 9.62 mm
 Trefferlage: 0.42 mm links, 0.58 mm hoch

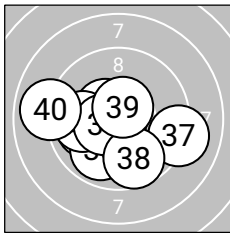
**Serie 4: 99.9** (94)

10.5*↖	10.0↙	9.9↘	10.8*↘	9.9↙
10.5*↖	9.1↗	9.7↘	10.6*↗	8.9↙

beste Teiler: 31.0 (34.), 91.1 (39.), 114.3 (36.)
 Trefferkreis: 14.16 mm
 Trefferlage: 0.75 mm links, 0.57 mm tief



Ergebnis: **413.9 (394)**
 Serien: 103.2 103.8 103.3 103.6
 Zähler: 34 6 0 0 0 0 0 0 0 0
 Innenzehner: 29
 Weitester: 348 (28.), 317 (38.), 289 (17.)
 beste Teiler: 24.3 (32.), 45.8 (20.), 52.8 (16.)
 Trefferkreis: 10.84 mm
 Trefferlage: 0.22 mm links, 0.26 mm tief

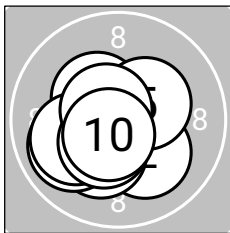
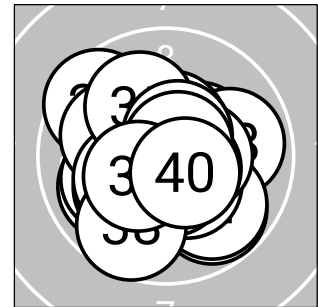

Serie 1: 103.2 (99)

10.7*←	10.1↘	10.2*↙	10.4*↖	10.3*↗
9.9↙	10.0↙	10.4*↙	10.6*↖	10.6*↙

beste Teiler: 53.0 (1.), 76.8 (9.), 86.8 (10.)
 Trefferkreis: 8.56 mm
 Trefferlage: 0.58 mm links, 0.48 mm tief

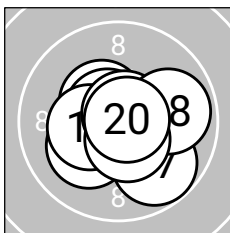

Serie 2: 103.8 (98)

10.7*→	10.4*↖	10.6*↖	10.1↙	10.3*←
10.7*↗	9.8↘	9.9→	10.5*↘	10.8*→

beste Teiler: 45.8 (20.), 52.8 (16.), 56.0 (11.)
 Trefferkreis: 9.04 mm
 Trefferlage: 0.18 mm rechts, 0.21 mm tief

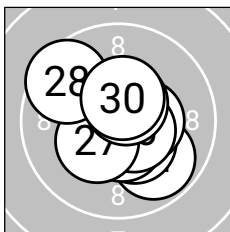

Serie 3: 103.3 (98)

9.9↘	10.4*↘	10.5*↓	10.7*←	10.4*→
10.6*↘	10.3*↙	9.6↖	10.5*↗	10.4*↑

beste Teiler: 61.0 (24.), 98.2 (26.), 103.8 (29.)
 Trefferkreis: 10.71 mm
 Trefferlage: 0.13 mm rechts, 0.14 mm tief

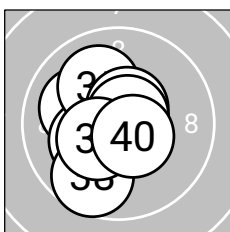

Serie 4: 103.6 (99)

10.5*↙	10.9*↓	10.1↖	10.2*↙	10.0↖
10.6*↗	10.7*↗	9.7↙	10.4*↙	10.5*↘

beste Teiler: 24.3 (32.), 63.4 (37.), 96.7 (36.)
 Trefferkreis: 9.37 mm
 Trefferlage: 0.64 mm links, 0.21 mm tief

LG 40 ZR

StandNr: 109

Fiegl, Franz-Josef #70819290

Senioren_1m

Wertung

StartNr: 194

01.03.2026 15:33

SG_Aschau

SG Aschau 1

Ergebnis: **419.8** (400)
 Serien: 104.4 104.5 105.4 105.5
 Zähler: 40 0 0 0 0 0 0 0 0 0 0
 Innenzehner: 37
 Weitester: 226 (3.), 224 (18.), 201 (12.)
 beste Teiler: 35.1 (7.), 60.4 (11.), 61.7 (40.)
 Trefferkreis: 8.72 mm
 Trefferlage: 0.07 mm links, 0.11 mm hoch

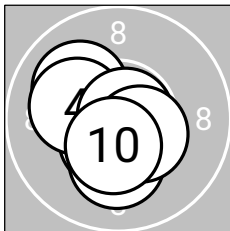
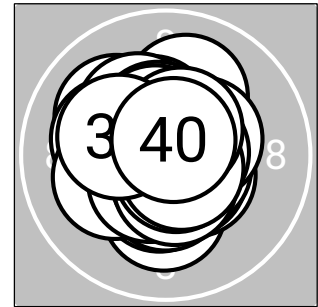

Serie 1: 104.4 (100)

10.7*↙	10.5*↙	10.0↖	10.2*↖	10.6*↘
10.5*↘	10.8*→	10.2*↓	10.5*↘	10.4*↓

beste Teiler: 35.1 (7.), 62.1 (1.), 99.9 (5.)
 Trefferkreis: 8.26 mm
 Trefferlage: 0.29 mm links, 0.50 mm tief

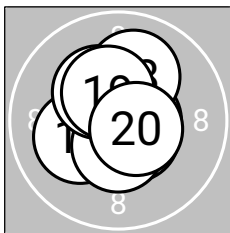

Serie 2: 104.5 (100)

10.7*↙	10.1↖	10.6*↘	10.6*↗	10.5*↓
10.3*↖	10.6*→	10.1↗	10.4*↖	10.6*↘

beste Teiler: 60.4 (11.), 80.0 (17.), 86.1 (14.)
 Trefferkreis: 8.39 mm
 Trefferlage: 0.03 mm links, 0.21 mm hoch

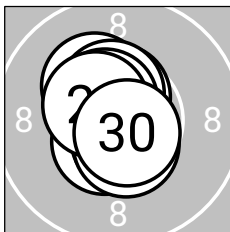

Serie 3: 105.4 (100)

10.2*↖	10.7*↖	10.5*↙	10.6*↑	10.5*↑
10.6*↖	10.6*↓	10.5*↓	10.5*↖	10.7*↘

beste Teiler: 65.4 (30.), 66.8 (22.), 82.5 (27.)
 Trefferkreis: 7.30 mm
 Trefferlage: 0.29 mm links, 0.23 mm hoch

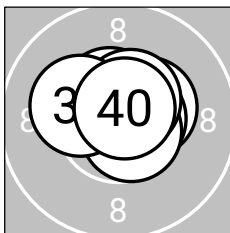

Serie 4: 105.5 (100)

10.7*↗	10.5*→	10.7*↗	10.4*→	10.6*→
10.7*↘	10.5*↖	10.5*↗	10.2*↖	10.7*↗

beste Teiler: 61.7 (40.), 64.4 (31.), 69.8 (33.)
 Trefferkreis: 7.45 mm
 Trefferlage: 0.30 mm rechts, 0.50 mm hoch



LG 40 ZR

StandNr: 110

Oberhauser, Wolfgang #70819210**Senioren_1m**

Wertung

StartNr: 195

01.03.2026 15:34

SG_Angerberg

SG Angerberg 1

Ergebnis: **416.7** (399)
 Serien: 103.8 105.3 104.4 103.2
 Zähler: 39 1 0 0 0 0 0 0 0 0
 Innenzehner: 32
 Weitestе: 313 (32.), 237 (34.), 216 (5.)
 beste Teiler: 29.2 (8.), 31.3 (28.), 38.8 (36.)
 Trefferkreis: 9.59 mm
 Trefferlage: 0.19 mm links, 0.02 mm hoch

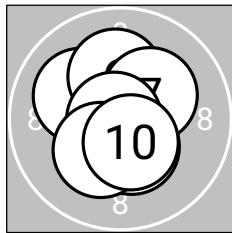
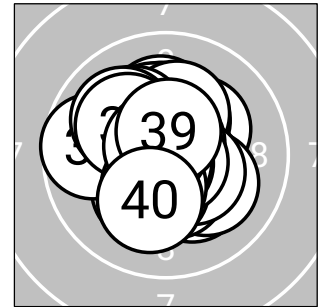
**Serie 1: 103.8** (100)

10.6*↓	10.3*↖	10.4*↓	10.5*↓	10.1↖
10.1↑	10.2*↗	10.8*←	10.3*↙	10.5*↓

beste Teiler: 29.2 (8.), 87.5 (1.), 108.3 (4.)
 Trefferkreis: 8.19 mm
 Trefferlage: 0.23 mm links, 0.06 mm tief

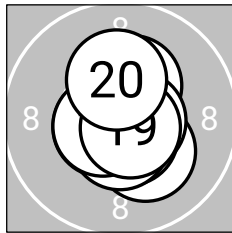
**Serie 2: 105.3** (100)

10.7*↗	10.6*↖	10.3*↗	10.2*↓	10.6*↓
10.6*↓	10.6*↖	10.7*↗	10.7*↓	10.3*↑

beste Teiler: 61.5 (19.), 68.8 (11.), 70.7 (18.)
 Trefferkreis: 7.95 mm
 Trefferlage: 0.16 mm rechts, 0.05 mm tief

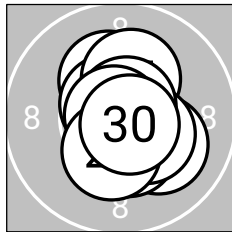
**Serie 3: 104.4** (100)

10.2*↑	10.1↘	10.6*↖	10.2*↑	10.4*↓
10.4*↘	10.7*↗	10.8*↖	10.3*↓	10.7*↘

beste Teiler: 31.3 (28.), 51.0 (30.), 59.9 (27.)
 Trefferkreis: 8.19 mm
 Trefferlage: 0.26 mm rechts, 0.02 mm tief

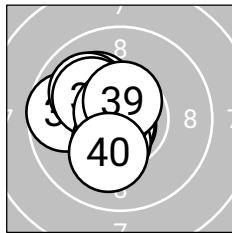
**Serie 4: 103.2** (99)

10.1↖	9.7←	10.8*↓	10.0↖	10.1↖
10.8*↙	10.4*↓	10.7*↖	10.5*↑	10.1↓

beste Teiler: 38.8 (36.), 41.6 (33.), 56.5 (38.)
 Trefferkreis: 8.23 mm
 Trefferlage: 0.99 mm links, 0.22 mm hoch