

Ergebnis: **418.2** (396)
Serien: 103.4 104.9 106.4 103.5
Zähler: 36 4 0 0 0 0 0 0 0 0
Innenzehner: 34
Weiteste: 346 (4.), 337 (39.), 269 (6.)
beste Teiler: 7.8 (16.), 22.2 (3.), 44.6 (27.)
Trefferkreis: 10.56 mm
Trefferlage: 0.07 mm links, 0.32 mm tief

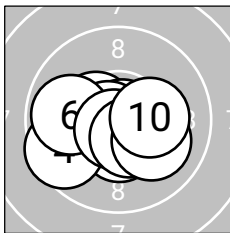
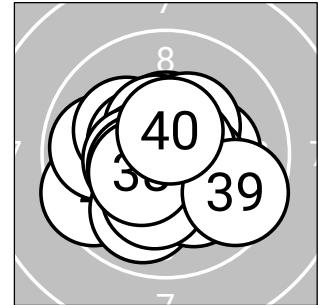

Serie 1: 103.4 (98)

10.4*↓	10.4*←	10.9*→	9.6←	10.7*←
9.9←	10.7*↓	10.5*↓	10.1→	10.2*→

beste Teiler: 22.2 (3.), 58.4 (5.), 59.0 (7.)
Trefferkreis: 9.63 mm
Trefferlage: 0.32 mm links, 0.48 mm tief

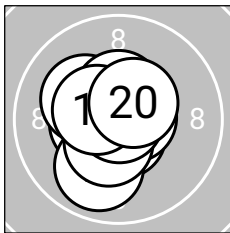

Serie 2: 104.9 (99)

10.7*↓	10.7*→	10.5*←	9.9↓	10.5*↓
10.9*↗	10.2*←	10.5*↑	10.5*←	10.5*↗

beste Teiler: 7.8 (16.), 69.5 (12.), 74.9 (11.)
Trefferkreis: 8.27 mm
Trefferlage: 0.37 mm links, 0.06 mm tief

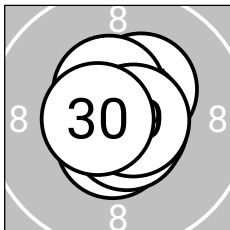

Serie 3: 106.4 (100)

10.7*↙	10.7*↘	10.7*↓	10.6*↓	10.7*↓
10.4*↗	10.8*→	10.5*↖	10.7*→	10.6*←

beste Teiler: 44.6 (27.), 57.2 (23.), 58.1 (21.)
Trefferkreis: 6.91 mm
Trefferlage: 0.11 mm rechts, 0.05 mm tief

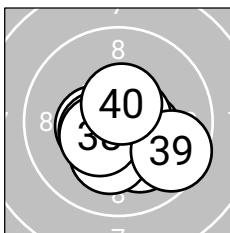

Serie 4: 103.5 (99)

10.4*↘	10.7*→	10.1↓	10.4*←	10.5*←
10.6*↓	10.2*↓	10.4*←	9.6→	10.6*↑

beste Teiler: 71.8 (32.), 99.6 (40.), 100.6 (36.)
Trefferkreis: 8.94 mm
Trefferlage: 0.29 mm rechts, 0.70 mm tief



Ergebnis: 416.4 (398)
Serien: 103.9 104.8 103.9 103.8
Zähler: 38 2 0 0 0 0 0 0 0 0
Innenzehner: 35
Weiteste: 419 (6.), 283 (32.), 246 (29.)
beste Teiler: 21.5 (36.), 22.3 (18.), 34.8 (15.)
Trefferkreis: 11.06 mm
Trefferlage: 0.00 mm , 0.12 mm hoch

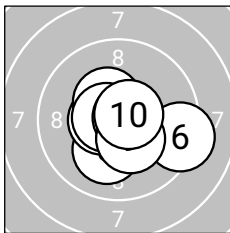
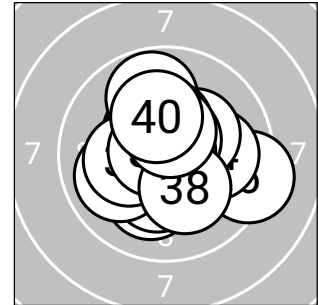

Serie 1: 103.9 (99)

10.7*←	10.6*←	10.1↓	10.5*←	10.4*↖
9.3→	10.6*←	10.7*→	10.4*↓	10.6*→

beste Teiler: 58.9 (8.), 62.1 (1.), 76.0 (10.)
Trefferkreis: 9.85 mm
Trefferlage: 0.14 mm rechts, 0.28 mm tief

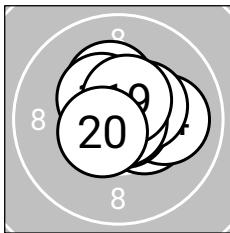

Serie 2: 104.8 (100)

10.6*↑	10.3*↑	10.4*→	10.0→	10.8*→
10.4*→	10.4*↖	10.9*→	10.5*↑	10.5*↖

beste Teiler: 22.3 (18.), 34.8 (15.), 85.0 (11.)
Trefferkreis: 7.92 mm
Trefferlage: 0.34 mm rechts, 0.37 mm hoch

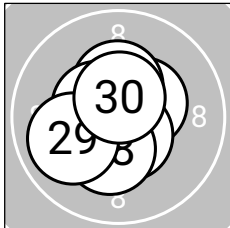

Serie 3: 103.9 (100)

10.4*→	10.5*↖	10.3*↑	10.6*↓	10.4*↓
10.5*↖	10.3*↖	10.3*↓	10.0←	10.6*↑

beste Teiler: 96.1 (30.), 99.2 (24.), 114.4 (26.)
Trefferkreis: 8.31 mm
Trefferlage: 0.46 mm links, 0.31 mm tief

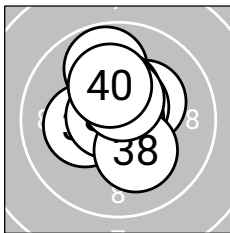

Serie 4: 103.8 (99)

10.3*→	9.8↑	10.2*←	10.4*↑	10.6*↗
10.9*→	10.7*←	10.2*↓	10.5*↑	10.2*↑

beste Teiler: 21.5 (36.), 60.4 (37.), 83.4 (35.)
Trefferkreis: 9.19 mm
Trefferlage: 0.02 mm links, 0.70 mm hoch



Ergebnis: **417.7 (400)**
 Serien: 104.2 105.0 104.8 103.7
 Zähler: 40 0 0 0 0 0 0 0 0 0 0
 Innenzehner: 38
 Weitester: 221 (33.), 209 (22.), 200 (32.)
 beste Teiler: 31.3 (23.), 34.9 (25.), 41.7 (26.)
 Trefferkreis: 8.55 mm
 Trefferlage: 0.02 mm links, 0.20 mm hoch

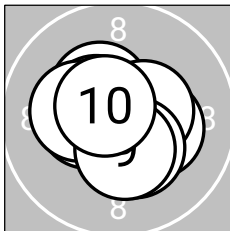
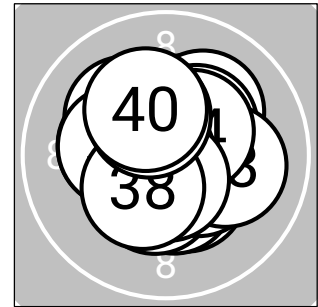

Serie 1: 104.2 (100)
 10.4*↘ 10.4*← 10.4*↗ 10.5*↖ 10.3*→
 10.5*→ 10.4*↘ 10.3*← 10.4*↓ 10.6*↖
 beste Teiler: 83.4 (10.), 115.2 (4.), 118.5 (6.)
 Trefferkreis: 7.90 mm
 Trefferlage: 0.10 mm links, 0.11 mm tief

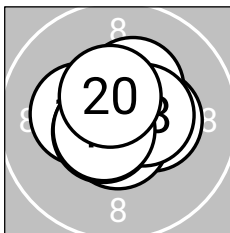

Serie 2: 105.0 (100)
 10.4*→ 10.6*↓ 10.3*← 10.6*↗ 10.5*↗
 10.3*↗ 10.6*↖ 10.5*→ 10.7*↖ 10.5*↖
 beste Teiler: 75.1 (19.), 77.0 (12.), 82.2 (17.)
 Trefferkreis: 7.62 mm
 Trefferlage: 0.11 mm rechts, 0.28 mm hoch

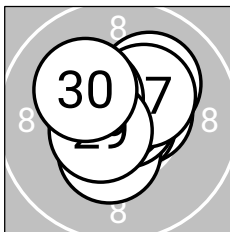

Serie 3: 104.8 (100)
 10.5*→ 10.1 ↗ 10.8*↘ 10.4*↓ 10.8*↗
 10.8*↑ 10.3*↗ 10.3*↖ 10.6*↖ 10.2*↖
 beste Teiler: 31.3 (23.), 34.9 (25.), 41.7 (26.)
 Trefferkreis: 8.07 mm
 Trefferlage: 0.02 mm rechts, 0.39 mm hoch

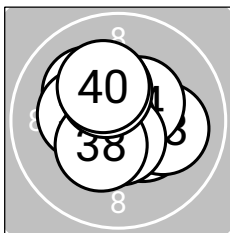

Serie 4: 103.7 (100)
 10.4*↘ 10.2*↖ 10.1 → 10.4*↗ 10.8*←
 10.6*↓ 10.3*← 10.4*↖ 10.3*↖ 10.2*↖
 beste Teiler: 46.0 (35.), 89.2 (36.), 131.7 (34.)
 Trefferkreis: 8.55 mm
 Trefferlage: 0.13 mm links, 0.24 mm hoch



Ergebnis: **417.3** (396)
 Serien: 104.5 104.7 104.2 103.9
 Zähler: 36 4 0 0 0 0 0 0 0 0
 Innenzehner: 36
 Weitest: 387 (31.), 275 (37.), 273 (21.)
 beste Teiler: 11.0 (8.), 40.8 (15.), 49.8 (24.)
 Trefferkreis: 10.00 mm
 Trefferlage: 0.39 mm rechts, 0.16 mm tief

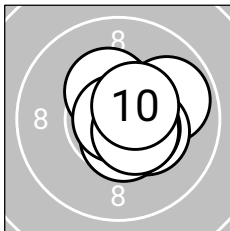
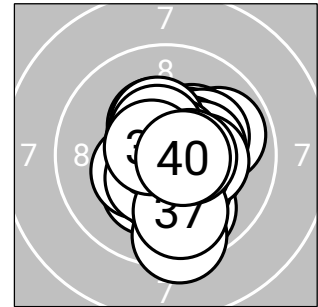

Serie 1: 104.5 (99)

10.4*↗	9.9↗	10.6*↘	10.4*↖	10.3*↘
10.5*↘	10.5*↘	10.9*↖	10.5*↘	10.5*↘

beste Teiler: 11.0 (8.), 84.0 (3.), 101.6 (6.)
 Trefferkreis: 7.82 mm
 Trefferlage: 0.66 mm rechts, 0.12 mm hoch

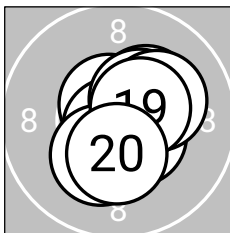

Serie 2: 104.7 (100)

10.3*↗	10.7*↗	10.6*↖	10.5*↘	10.8*↘
10.4*↗	10.3*↘	10.2*↗	10.5*↘	10.4*↘

beste Teiler: 40.8 (15.), 58.2 (12.), 82.8 (13.)
 Trefferkreis: 8.01 mm
 Trefferlage: 0.42 mm rechts, 0.07 mm hoch

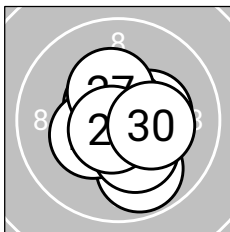

Serie 3: 104.2 (99)

9.9↘	10.3*↗	10.7*↖	10.8*↗	10.6*↖
10.3*↖	10.3*↗	10.3*↘	10.7*↘	10.3*↗

beste Teiler: 49.8 (24.), 56.5 (23.), 59.6 (29.)
 Trefferkreis: 8.73 mm
 Trefferlage: 0.23 mm rechts, 0.24 mm tief

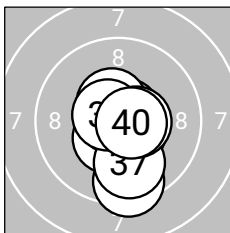

Serie 4: 103.9 (98)

9.4↘	10.5*↘	10.7*↗	10.7*↖	10.5*↖
10.5*↘	9.9↘	10.5*↗	10.6*↖	10.6*↗

beste Teiler: 58.1 (34.), 62.2 (33.), 76.5 (39.)
 Trefferkreis: 9.50 mm
 Trefferlage: 0.24 mm rechts, 0.61 mm tief

LG 40 ZR

StandNr: 116

Haslwanter, Armin #70819226

Senioren_2m

Wertung

StartNr: 62

01.03.2026 11:11

SG_Scharnitz

SG Scharnitz 1

Ergebnis: **410.5** (394)
 Serien: 103.6 101.4 103.1 102.4
 Zähler: 34 6 0 0 0 0 0 0 0 0 0
 Innenzehner: 24
 Weitestе: 383 (12.), 314 (20.), 311 (31.)
 beste Teiler: 21.3 (16.), 55.6 (11.), 55.8 (33.)
 Trefferkreis: 10.96 mm
 Trefferlage: 0.83 mm links, 0.13 mm hoch

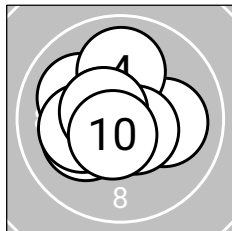
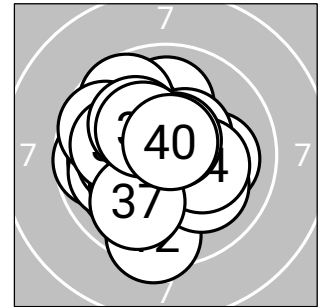
**Serie 1: 103.6** (100)

10.1 ↖	10.1 →	10.6* ↖	10.0 ↑	10.2* ↖
10.6* ↖	10.6* ↘	10.2* ↖	10.6* ↖	10.6* ↘

beste Teiler: 77.6 (3.), 89.8 (10.), 91.2 (7.)
 Trefferkreis: 8.87 mm
 Trefferlage: 0.54 mm links, 0.16 mm hoch

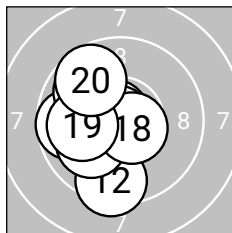
**Serie 2: 101.4** (96)

10.7* ↖	9.4 ↓	9.7 ←	10.5* ↖	9.9 ↖
10.9* ↖	10.0 ↖	10.6* ↘	10.0 ←	9.7 ↖

beste Teiler: 21.3 (16.), 55.6 (11.), 87.3 (18.)
 Trefferkreis: 10.95 mm
 Trefferlage: 1.27 mm links, 0.11 mm tief

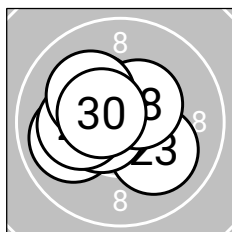
**Serie 3: 103.1** (100)

10.2* ↖	10.5* ↗	10.1 ↘	10.0 ←	10.5* ↖
10.6* ↖	10.2* ←	10.4* ↗	10.1 ↖	10.5* ↖

beste Teiler: 98.6 (26.), 105.1 (30.), 106.6 (22.)
 Trefferkreis: 8.83 mm
 Trefferlage: 0.66 mm links, 0.29 mm hoch

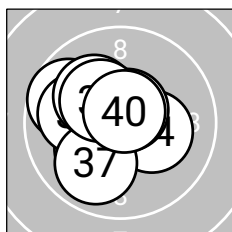
**Serie 4: 102.4** (98)

9.7 ↖	10.2* ↖	10.7* ↖	10.2* →	10.0 ←
10.6* ↗	9.9 ↖	10.1 ↖	10.3* ↖	10.7* ↗

beste Teiler: 55.8 (33.), 65.4 (40.), 79.6 (36.)
 Trefferkreis: 9.41 mm
 Trefferlage: 0.84 mm links, 0.20 mm hoch

Ergebnis: **411.8** (393)
 Serien: 101.7 103.4 103.0 103.7
 Zähler: 34 5 1 0 0 0 0 0 0 0
 Innenzehner: 30
 Weitestе: 544 (9.), 378 (23.), 315 (3.)
 beste Teiler: 22.8 (25.), 33.3 (20.), 35.9 (22.)
 Trefferkreis: 13.04 mm
 Trefferlage: 0.01 mm rechts, 0.27 mm tief

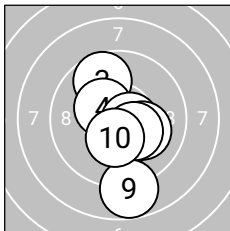
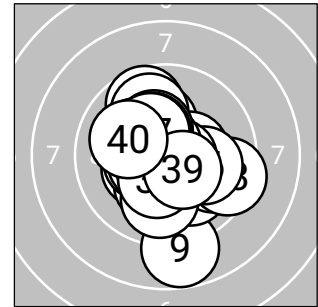

Serie 1: 101.7 (97)

10.6*↓ 10.3*↓ 9.7↗
 10.6*→ 10.1→ 10.3*↘
 beste Teiler: 77.1 (1.), 91.6 (6.), 114.1 (5.)
 Trefferkreis: 13.04 mm
 Trefferlage: 0.29 mm rechts, 0.84 mm tief

10.4*↖ 10.5*↘
 8.8↓ 10.4*↓

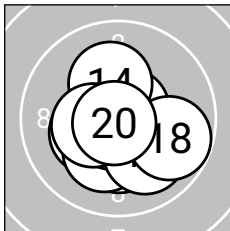

Serie 2: 103.4 (99)

10.7*↗ 10.3*↓ 10.3*↖
 10.7*↘ 10.0↘ 9.8→
 beste Teiler: 33.3 (20.), 60.2 (16.), 67.9 (11.)
 Trefferkreis: 9.03 mm
 Trefferlage: 0.01 mm rechts, 0.58 mm tief

10.2*↑ 10.2*↘
 10.4*↖ 10.8*↖

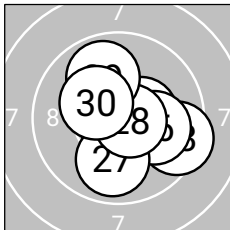

Serie 3: 103.0 (97)

10.7*↗ 10.8*↖ 9.4→
 10.0→ 9.9↓ 10.7*→
 beste Teiler: 22.8 (25.), 35.9 (22.), 59.0 (21.)
 Trefferkreis: 10.46 mm
 Trefferlage: 0.51 mm rechts, 0.04 mm tief

10.4*→ 10.9*↓
 9.9↗ 10.3*↖

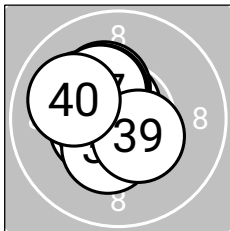

Serie 4: 103.7 (100)

10.2*↖ 10.7*↑ 10.3*↖
 10.6*↖ 10.3*↖ 10.4*↓
 beste Teiler: 65.1 (32.), 86.4 (36.), 118.4 (34.)
 Trefferkreis: 8.10 mm
 Trefferlage: 0.77 mm links, 0.36 mm hoch

10.5*↖ 10.3*↖
 10.4*↘ 10.0↖

LG 40 ZR

StandNr: 120

Thaler, Günther #70819229

Senioren_2m

Wertung

StartNr: 66

01.03.2026 11:16

SG_Kundl

SG Kundl 2

Ergebnis: **420.0** (397)
 Serien: 105.5 104.1 104.8 105.6
 Zähler: 37 3 0 0 0 0 0 0 0 0
 Innenzehner: 35
 Weitestе: 376 (21.), 260 (11.), 252 (20.)
 beste Teiler: 6.0 (1.), 12.1 (13.), 14.3 (30.)
 Trefferkreis: 10.08 mm
 Trefferlage: 0.19 mm rechts, 0.11 mm hoch

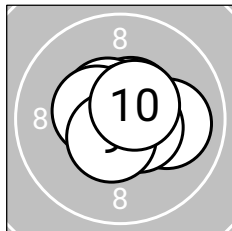
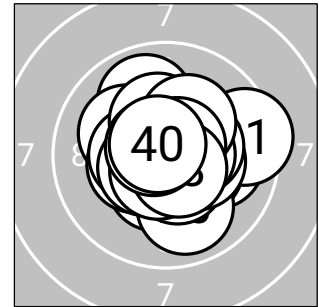
**Serie 1: 105.5** (100)

10.9*←	10.6*→	10.6*↗	10.5*↖	10.0→
10.7*↗	10.6*↘	10.5*←	10.5*↘	10.6*↗

beste Teiler: 6.0 (1.), 61.5 (6.), 83.9 (2.)
 Trefferkreis: 8.05 mm
 Trefferlage: 0.33 mm rechts, 0.18 mm hoch

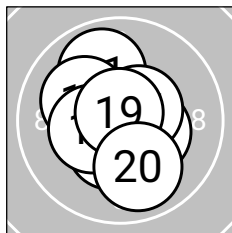
**Serie 2: 104.1** (98)

9.9↗	10.1↖	10.9*→	10.4*→	10.5*↗
10.4*↘	10.8*←	10.4*←	10.8*↗	9.9↘

beste Teiler: 12.1 (13.), 40.0 (17.), 41.4 (19.)
 Trefferkreis: 9.63 mm
 Trefferlage: 0.18 mm links, 0.02 mm tief

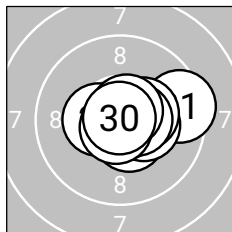
**Serie 3: 104.8** (99)

9.4→	10.5*↘	10.4*→	10.4*→	10.4*←
10.8*↘	10.6*→	10.7*↗	10.7*↘	10.9*↖

beste Teiler: 14.3 (30.), 27.7 (26.), 53.3 (29.)
 Trefferkreis: 9.58 mm
 Trefferlage: 0.69 mm rechts, 0.00 mm

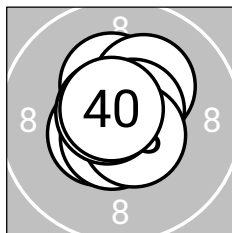
**Serie 4: 105.6** (100)

10.6*↗	10.3*↗	10.2*↗	10.7*↗	10.7*←
10.5*←	10.6*↘	10.6*↘	10.7*↖	10.7*↖

beste Teiler: 63.6 (40.), 66.1 (35.), 67.1 (39.)
 Trefferkreis: 7.33 mm
 Trefferlage: 0.07 mm links, 0.30 mm hoch

LG 40 ZR

StandNr: 121

Windbichler, Martin #70819036

Senioren_2m

Wertung

StartNr: 67

01.03.2026 11:12

SG_Hall

SG Hall 2

Ergebnis: **409.3 (393)**
 Serien: 101.3 101.5 103.6 102.9
 Zähler: 33 7 0 0 0 0 0 0 0 0
 Innenzehner: 27
 Weitest: 395 (14.), 335 (13.), 312 (1.)
 beste Teiler: 71.7 (27.), 77.6 (38.), 79.8 (19.)
 Trefferkreis: 11.67 mm
 Trefferlage: 0.22 mm links, 0.61 mm hoch

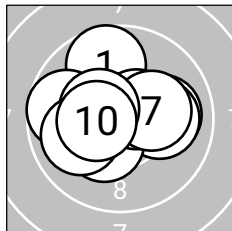
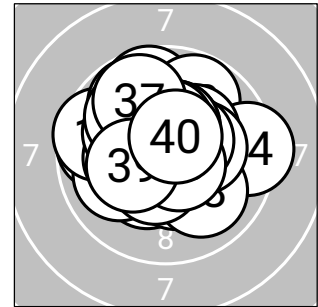
**Serie 1: 101.3 (98)**

9.7↑	10.0→	10.1→	10.3*↘	9.7←
10.5*↗	10.2*↗	10.4*←	10.0←	10.4*←

beste Teiler: 105.8 (6.), 131.5 (8.), 134.5 (10.)
 Trefferkreis: 9.87 mm
 Trefferlage: 0.22 mm links, 0.29 mm hoch

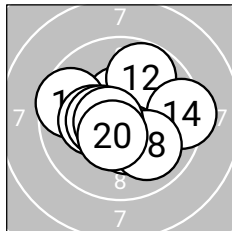
**Serie 2: 101.5 (97)**

10.5*↑	9.8↗	9.6←	9.4→	10.3*←
10.4*←	10.4*↘	10.0↘	10.6*←	10.5*↘

beste Teiler: 79.8 (19.), 111.1 (11.), 120.3 (20.)
 Trefferkreis: 11.67 mm
 Trefferlage: 0.01 mm links, 0.04 mm hoch

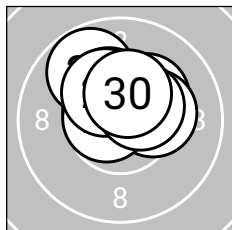
**Serie 3: 103.6 (99)**

10.3*↗	10.6*←	9.8↘	10.3*→	10.4*↑
10.3*↘	10.7*←	10.3*↘	10.5*↗	10.4*↑

beste Teiler: 71.7 (27.), 86.8 (22.), 125.9 (29.)
 Trefferkreis: 8.34 mm
 Trefferlage: 0.02 mm links, 1.08 mm hoch

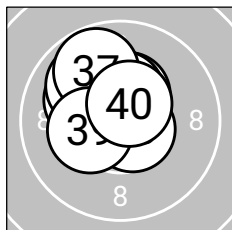
**Serie 4: 102.9 (99)**

10.1←	10.5*←	10.4*↑	10.0↘	10.3*↘
10.4*↑	9.8↘	10.6*↘	10.3*←	10.5*↗

beste Teiler: 77.6 (38.), 101.5 (40.), 105.6 (32.)
 Trefferkreis: 8.13 mm
 Trefferlage: 0.63 mm links, 1.01 mm hoch



Ergebnis: **411.1** (395)
 Serien: 102.7 102.6 102.8 103.0
 Zähler: 35 5 0 0 0 0 0 0 0 0 0
 Innenzehner: 26
 Weitestе: 368 (1.), 318 (16.), 317 (28.)
 beste Teiler: 40.1 (26.), 55.9 (33.), 65.1 (4.)
 Trefferkreis: 11.12 mm
 Trefferlage: 0.08 mm rechts, 0.35 mm tief

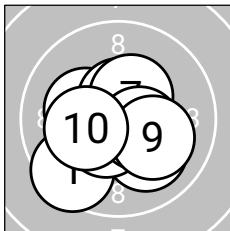
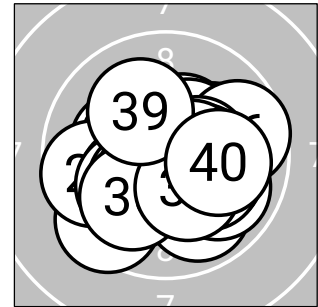

Serie 1: 102.7 (99)

9.5 ↙	10.2* ←	10.1 ↘	10.7* →	10.5* ↙
10.5* ↑	10.4* ↗	10.5* →	10.1 ↘	10.2* ←

beste Teiler: 65.1 (4.), 101.1 (6.), 111.0 (5.)
 Trefferkreis: 9.58 mm
 Trefferlage: 0.07 mm links, 0.48 mm tief

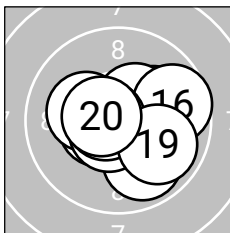

Serie 2: 102.6 (97)

9.9 ↘	10.1 →	10.4* ↗	10.5* ←	10.2* ←
9.7 →	10.6* ↙	10.7* ←	9.9 ↘	10.6* ←

beste Teiler: 71.0 (18.), 83.8 (17.), 97.7 (20.)
 Trefferkreis: 9.51 mm
 Trefferlage: 0.44 mm rechts, 0.11 mm tief

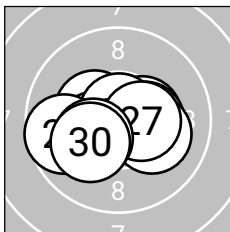

Serie 3: 102.8 (99)

10.4* ←	10.4* →	10.3* →	10.4* ←	10.1 ↘
10.8* ↑	10.4* →	9.7 ←	10.2* ←	10.1 ↙

beste Teiler: 40.1 (26.), 130.1 (27.), 137.1 (22.)
 Trefferkreis: 9.47 mm
 Trefferlage: 0.26 mm links, 0.34 mm tief

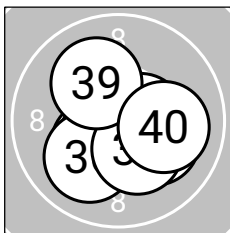

Serie 4: 103.0 (100)

10.5* ↘	10.3* ↙	10.7* ↖	10.5* ↙	10.5* →
10.0 ↙	10.1 ↘	10.3* ↘	10.1 ↖	10.0 →

beste Teiler: 55.9 (33.), 108.3 (35.), 109.2 (31.)
 Trefferkreis: 8.95 mm
 Trefferlage: 0.24 mm rechts, 0.47 mm tief



LG 40 ZR

StandNr: 123

Bucher, Reinhold #70819231

Senioren_2m

Wertung

StartNr: 69

01.03.2026 11:18

SG_Fieberbrunn

SG Fieberbrunn 1

Ergebnis: **415.0** (397)
 Serien: 104.2 102.0 103.2 105.6
 Zähler: 37 3 0 0 0 0 0 0 0 0
 Innenzehner: 33
 Weitester: 428 (30.), 279 (11.), 270 (14.)
 beste Teiler: 7.6 (40.), 28.6 (29.), 38.9 (37.)
 Trefferkreis: 10.83 mm
 Trefferlage: 0.10 mm rechts, 0.04 mm hoch

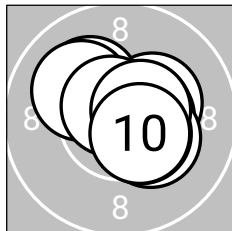
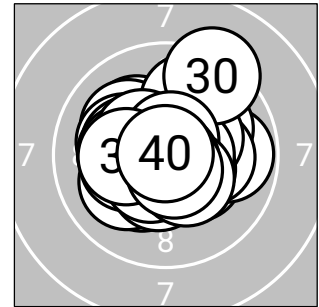
**Serie 1: 104.2** (100)

10.3*➔	10.2*↖	10.5*➔	10.1↖	10.7*↖
10.5*➔	10.3*↘	10.5*↘	10.6*➔	10.5*↘

beste Teiler: 71.6 (5.), 99.9 (9.), 102.7 (6.)
 Trefferkreis: 8.27 mm
 Trefferlage: 0.41 mm rechts, 0.26 mm hoch

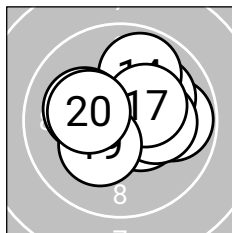
**Serie 2: 102.0** (98)

9.8➔	10.5*↘	10.1↗	9.9↗	10.6*↖
10.2*➔	10.3*↗	10.1↖	10.3*↖	10.2*↖

beste Teiler: 85.4 (15.), 120.0 (12.), 159.1 (17.)
 Trefferkreis: 9.26 mm
 Trefferlage: 0.46 mm rechts, 0.33 mm hoch

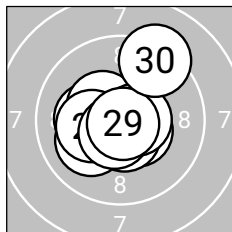
**Serie 3: 103.2** (99)

10.2*↖	10.1↖	10.5*↘	10.4*↖	10.6*↘
10.2*↖	10.6*↘	10.6*➔	10.8*↘	9.2↗

beste Teiler: 28.6 (29.), 85.9 (27.), 95.0 (28.)
 Trefferkreis: 10.83 mm
 Trefferlage: 0.23 mm links, 0.04 mm hoch

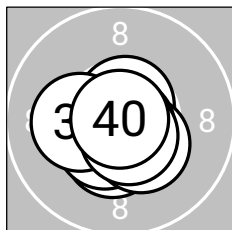
**Serie 4: 105.6** (100)

10.6*↘	10.5*↖	10.7*↗	10.4*↘	10.5*↖
10.4*↘	10.8*↘	10.2*↖	10.6*↘	10.9*↖

beste Teiler: 7.6 (40.), 38.9 (37.), 74.6 (33.)
 Trefferkreis: 7.47 mm
 Trefferlage: 0.20 mm links, 0.47 mm tief

LG 40 ZR

StandNr: 124

Ledermaid, Rainer #70819232

Senioren_2m

Wertung

StartNr: 70

01.03.2026 11:30

SG_Kundl

SG Kundl 3

Ergebnis: **420.3** (399)
 Serien: 104.3 106.7 105.3 104.0
 Zähler: 39 1 0 0 0 0 0 0 0 0
 Innenzehner: 36
 Weitest: 263 (32.), 242 (3.), 226 (34.)
 beste Teiler: 18.4 (13.), 18.6 (10.), 18.6 (25.)
 Trefferkreis: 9.27 mm
 Trefferlage: 0.17 mm rechts, 0.24 mm tief

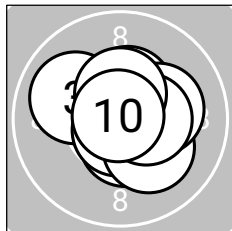
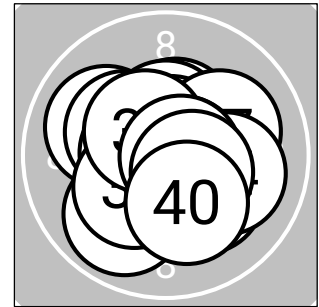
**Serie 1: 104.3** (100)

10.5*↓	10.5*↓	10.0↖	10.4*↑	10.7*↓
10.2*↘	10.2*→	10.4*→	10.5*↑	10.9*↖

beste Teiler: 18.6 (10.), 56.0 (5.), 104.5 (1.)
 Trefferkreis: 8.83 mm
 Trefferlage: 0.29 mm rechts, 0.01 mm hoch

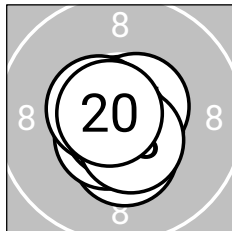
**Serie 2: 106.7** (100)

10.8*↑	10.7*↘	10.9*↗	10.4*↓	10.6*↖
10.6*↗	10.8*↖	10.5*↓	10.6*↖	10.8*↖

beste Teiler: 18.4 (13.), 31.0 (17.), 39.0 (11.)
 Trefferkreis: 6.79 mm
 Trefferlage: 0.02 mm links, 0.22 mm tief

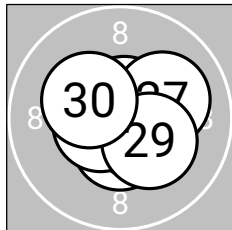
**Serie 3: 105.3** (100)

10.5*↓	10.8*→	10.6*↘	10.7*↑	10.9*↘
10.5*↘	10.1*→	10.6*↖	10.3*↘	10.3*↖

beste Teiler: 18.6 (25.), 38.0 (22.), 68.6 (24.)
 Trefferkreis: 8.09 mm
 Trefferlage: 0.33 mm rechts, 0.12 mm tief

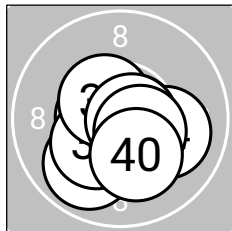
**Serie 4: 104.0** (99)

10.7*→	9.9↙	10.6*↖	10.0→	10.6*↓
10.3*↙	10.5*↖	10.7*→	10.5*↘	10.2*↘

beste Teiler: 55.3 (38.), 60.5 (31.), 92.3 (33.)
 Trefferkreis: 8.58 mm
 Trefferlage: 0.09 mm rechts, 0.64 mm tief

Ergebnis: 414.0 (396)
Serien: 101.8 104.4 104.8 103.0
Zähler: 36 4 0 0 0 0 0 0 0 0
Innenzehner: 30
Weiteste: 371 (38.), 276 (4.), 257 (5.)
beste Teiler: 26.2 (25.), 61.2 (1.), 68.2 (7.)
Trefferkreis: 10.89 mm
Trefferlage: 0.23 mm rechts, 0.07 mm hoch

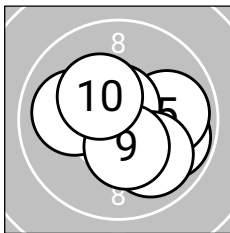
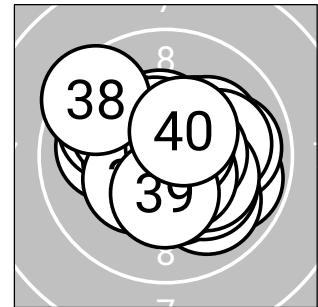

Serie 1: 101.8 (98)

10.7*↘ 10.0→ 10.0→ 9.8→ 9.9→
 10.0← 10.7*↑ 10.0↘ 10.4*↓ 10.3*↖

beste Teiler: 61.2 (1.), 68.2 (7.), 147.7 (9.)
Trefferkreis: 9.59 mm
Trefferlage: 0.90 mm rechts, 0.29 mm tief

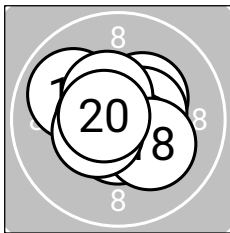

Serie 2: 104.4 (99)

9.9↖ 10.3*↗ 10.5*→ 10.6*↘ 10.5*↖
 10.6*← 10.6*↓ 10.2*↘ 10.5*← 10.7*←

beste Teiler: 71.8 (20.), 84.1 (16.), 93.0 (17.)
Trefferkreis: 8.99 mm
Trefferlage: 0.08 mm links, 0.02 mm hoch

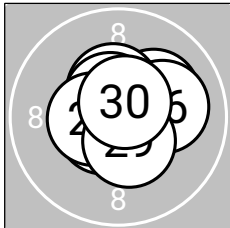

Serie 3: 104.8 (100)

10.2*↗ 10.4*↑ 10.6*↗ 10.6*↖ 10.8*↗
 10.1→ 10.6*↖ 10.5*← 10.4*↓ 10.6*↗

beste Teiler: 26.2 (25.), 78.7 (30.), 84.2 (23.)
Trefferkreis: 7.89 mm
Trefferlage: 0.27 mm rechts, 0.35 mm hoch

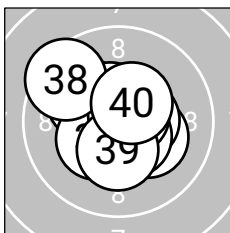

Serie 4: 103.0 (99)

10.1↖ 10.2*↘ 10.5*→ 10.5*↖ 10.5*↘
 10.3*↖ 10.7*↗ 9.5↖ 10.3*↓ 10.4*↗

beste Teiler: 70.4 (37.), 107.0 (35.), 111.4 (34.)
Trefferkreis: 10.02 mm
Trefferlage: 0.15 mm links, 0.18 mm hoch



LG 40 ZR

StandNr: 126

Jäger, Michael #70819234

Senioren_2m

Wertung

StartNr: 72

01.03.2026 11:25

SG_Imst

SG Imst 1

Ergebnis: **420.7** (400)
 Serien: 104.6 105.1 105.5 105.5
 Zähler: 40 0 0 0 0 0 0 0 0 0 0
 Innenzehner: 36
 Weitester: 240 (18.), 238 (2.), 234 (5.)
 beste Teiler: 37.3 (30.), 43.8 (29.), 46.0 (19.)
 Trefferkreis: 8.58 mm
 Trefferlage: 0.17 mm links, 0.11 mm tief

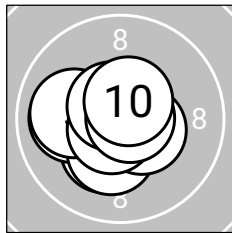
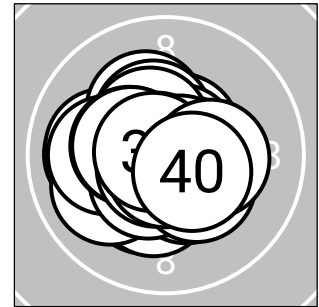
**Serie 1: 104.6** (100)

10.3*↙	10.0←	10.3*↓	10.8*↖	10.0←
10.5*↘	10.7*↗	10.6*↖	10.8*→	10.6*↗

beste Teiler: 46.6 (4.), 50.1 (9.), 68.8 (7.)
 Trefferkreis: 8.02 mm
 Trefferlage: 0.52 mm links, 0.20 mm tief

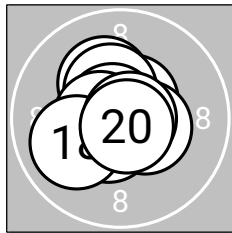
**Serie 2: 105.1** (100)

10.6*↙	10.6*↗	10.2*↖	10.4*↖	10.7*↖
10.4*↘	10.6*←	10.0←	10.8*→	10.8*↘

beste Teiler: 46.0 (19.), 49.0 (20.), 55.8 (15.)
 Trefferkreis: 8.15 mm
 Trefferlage: 0.27 mm links, 0.15 mm hoch

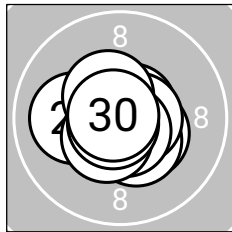
**Serie 3: 105.5** (100)

10.4*↘	10.4*↘	10.1←	10.7*↗	10.6*↘
10.7*↓	10.5*↖	10.5*↙	10.8*↖	10.8*↖

beste Teiler: 37.3 (30.), 43.8 (29.), 67.7 (26.)
 Trefferkreis: 7.96 mm
 Trefferlage: 0.06 mm links, 0.20 mm tief

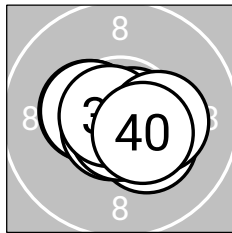
**Serie 4: 105.5** (100)

10.6*↘	10.4*←	10.7*→	10.4*←	10.3*↘
10.7*↙	10.8*↓	10.8*←	10.3*→	10.5*↘

beste Teiler: 49.0 (37.), 49.4 (38.), 53.0 (33.)
 Trefferkreis: 7.61 mm
 Trefferlage: 0.15 mm rechts, 0.22 mm tief

Ergebnis: **417.1** (399)
 Serien: 103.8 104.2 104.7 104.4
 Zähler: 39 1 0 0 0 0 0 0 0 0
 Innenzehner: 36
 Weitester: 263 (9.), 243 (6.), 225 (25.)
 beste Teiler: 31.0 (8.), 52.6 (5.), 57.2 (23.)
 Trefferkreis: 9.06 mm
 Trefferlage: 0.10 mm rechts, 0.43 mm hoch

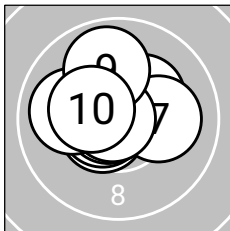
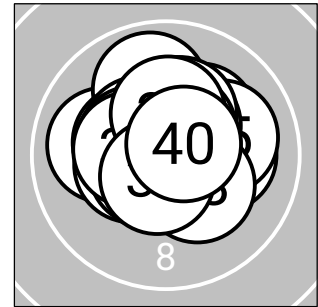

Serie 1: 103.8 (99)

10.4*←	10.6*←	10.3*↗	10.6*←	10.7*←
10.0←	10.1→	10.8*←	9.9↑	10.4*←

beste Teiler: 31.0 (8.), 52.6 (5.), 86.3 (4.)
 Trefferkreis: 9.02 mm
 Trefferlage: 0.49 mm links, 0.42 mm hoch

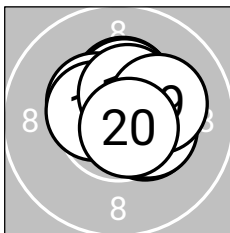

Serie 2: 104.2 (100)

10.5*↗	10.3*↑	10.4*↘	10.4*↘	10.4*↑
10.4*←	10.5*←	10.4*↑	10.2*↘	10.7*↘

beste Teiler: 58.2 (20.), 110.6 (11.), 112.5 (17.)
 Trefferkreis: 7.36 mm
 Trefferlage: 0.47 mm rechts, 0.55 mm hoch

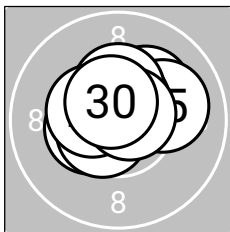

Serie 3: 104.7 (100)

10.4*←	10.6*←	10.7*↗	10.2*↗	10.1→
10.6*↗	10.4*↑	10.4*←	10.7*↗	10.6*↖

beste Teiler: 57.2 (23.), 63.1 (29.), 90.1 (26.)
 Trefferkreis: 8.15 mm
 Trefferlage: 0.09 mm rechts, 0.55 mm hoch

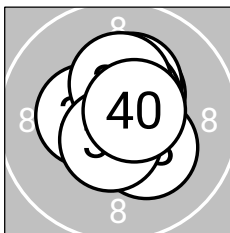

Serie 4: 104.4 (100)

10.4*↗	10.4*←	10.3*↑	10.5*↗	10.6*↘
10.3*↑	10.4*↘	10.3*↘	10.6*↘	10.6*↗

beste Teiler: 82.6 (40.), 90.2 (39.), 95.8 (35.)
 Trefferkreis: 7.69 mm
 Trefferlage: 0.36 mm rechts, 0.21 mm hoch



Ergebnis: **415.7 (395)**
 Serien: 104.4 103.5 103.2 104.6
 Zähler: 35 5 0 0 0 0 0 0 0 0
 Innenzehner: 29
 Weitester: 350 (11.), 313 (36.), 269 (24.)
 beste Teiler: 11.7 (19.), 12.8 (37.), 25.0 (30.)
 Trefferkreis: 10.95 mm
 Trefferlage: 0.57 mm links, 0.30 mm hoch

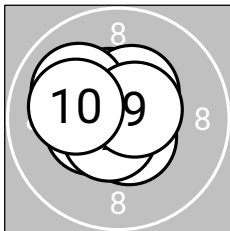
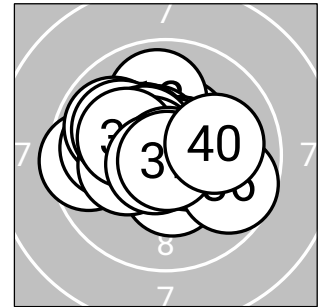

Serie 1: 104.4 (100)

10.6*↖	10.6*↘	10.5*↗	10.4*↗	10.4*↖
10.6*↖	10.6*↘	10.0↖	10.6*↗	10.1↖

beste Teiler: 81.6 (7.), 81.7 (6.), 81.8 (1.)
 Trefferkreis: 7.75 mm
 Trefferlage: 0.53 mm links, 0.36 mm hoch

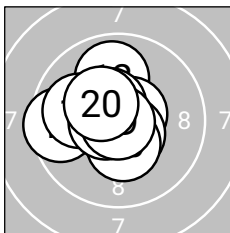

Serie 2: 103.5 (98)

9.6↖	9.9↗	10.6*↗	10.6*↘	10.4*↘
10.0↖	10.6*↖	10.5*↖	10.9*↘	10.4*↖

beste Teiler: 11.7 (19.), 76.7 (17.), 81.0 (13.)
 Trefferkreis: 9.19 mm
 Trefferlage: 0.70 mm links, 0.27 mm hoch

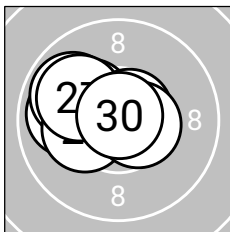

Serie 3: 103.2 (98)

10.8*↖	10.1↖	9.9↖	9.9↖	10.2*↖
10.2*↖	10.0↖	10.7*↗	10.5*↗	10.9*↗

beste Teiler: 25.0 (30.), 49.6 (21.), 71.0 (28.)
 Trefferkreis: 8.23 mm
 Trefferlage: 1.10 mm links, 0.43 mm hoch

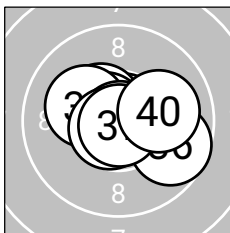

Serie 4: 104.6 (99)

10.5*↖	10.8*↗	10.4*↖	10.6*↖	10.2*↖
9.7↘	10.9*↘	10.7*↖	10.8*↘	10.0↗

beste Teiler: 12.8 (37.), 26.6 (39.), 44.6 (32.)
 Trefferkreis: 9.58 mm
 Trefferlage: 0.04 mm rechts, 0.14 mm hoch

LG 40 ZR

StandNr: 129

Felderer, Raimund #70818590

Senioren_2m

Wertung

StartNr: 75

01.03.2026 11:21

SG_Breitenbach

SG Breitenbach 1

Ergebnis: **425.0** (400)
 Serien: 106.2 106.1 106.3 106.4
 Zähler: 40 0 0 0 0 0 0 0 0 0 0
 Innenzehner: 40
 Weitester: 190 (15.), 178 (38.), 175 (25.)
 beste Teiler: 7.0 (3.), 8.9 (18.), 15.6 (40.)
 Trefferkreis: 8.15 mm
 Trefferlage: 0.02 mm links, 0.01 mm hoch

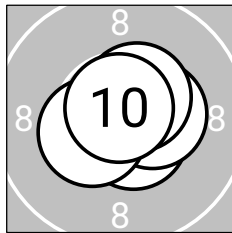
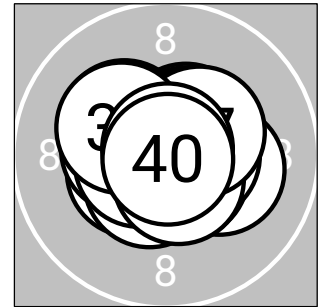
**Serie 1: 106.2** (100)

10.7*↖	10.6*↗	10.9*↓	10.6*→	10.7*→
10.6*↘	10.4*→	10.5*↗	10.4*←	10.8*↑

beste Teiler: 7.0 (3.), 45.2 (10.), 52.4 (1.)
 Trefferkreis: 7.11 mm
 Trefferlage: 0.30 mm rechts, 0.08 mm hoch

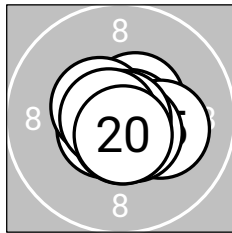
**Serie 2: 106.1** (100)

10.6*↖	10.5*↗	10.8*→	10.5*↖	10.2*→
10.7*↓	10.6*↘	10.9*→	10.7*←	10.6*↓

beste Teiler: 8.9 (18.), 43.0 (13.), 53.0 (19.)
 Trefferkreis: 7.47 mm
 Trefferlage: 0.17 mm rechts, 0.18 mm tief

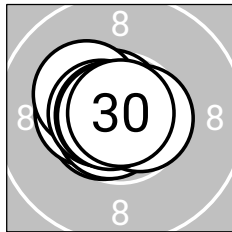
**Serie 3: 106.3** (100)

10.6*↖	10.4*←	10.7*↖	10.7*↖	10.3*↖
10.6*→	10.6*←	10.7*←	10.8*←	10.9*↑

beste Teiler: 21.0 (30.), 41.7 (29.), 51.4 (28.)
 Trefferkreis: 6.98 mm
 Trefferlage: 0.52 mm links, 0.18 mm hoch

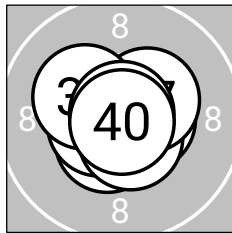
**Serie 4: 106.4** (100)

10.5*↖	10.6*→	10.8*←	10.6*←	10.9*→
10.6*↘	10.4*↗	10.2*↖	10.9*↑	10.9*↘

beste Teiler: 15.6 (40.), 17.0 (35.), 22.8 (39.)
 Trefferkreis: 7.32 mm
 Trefferlage: 0.04 mm links, 0.02 mm tief