

**Ergebnis: 396.5 (379)**  
**Serien:** 97.0 99.2 97.9 102.4  
**Zähler:** 20 19 1 0 0 0 0 0 0 0  
**Innenzehner:** 14  
**Weiteste:** 530 (3.), 475 (5.), 457 (28.)  
**beste Teiler:** 51.1 (12.), 60.6 (38.), 61.1 (36.)  
**Trefferkreis:** 13.79 mm  
**Trefferlage:** 0.64 mm links, 0.09 mm hoch

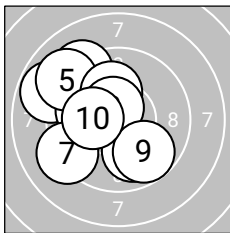
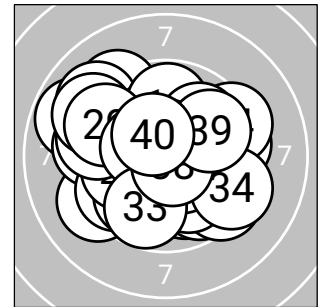

**Serie 1: 97.0 (94)**

9.2 ↖	10.0 ↘	8.8 ↖	10.0 ↖	9.1 ↖
10.1 ↗	9.2 ↖	10.6* ↗	9.8 ↘	10.2* ↖

**beste Teiler:** 96.2 (8.), 186.3 (10.), 206.4 (6.)  
**Trefferkreis:** 12.54 mm  
**Trefferlage:** 1.71 mm links, 0.51 mm hoch

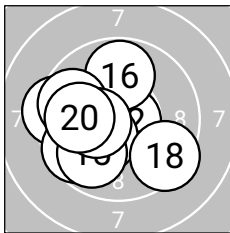

**Serie 2: 99.2 (94)**

9.4 ↖	10.7* ↗	10.3* ↖	9.6 ↖	9.9 ↗
9.8 ↗	9.7 ↖	9.4 ↘	10.4* ↖	10.0 ↖

**beste Teiler:** 51.1 (12.), 142.8 (19.), 153.2 (13.)  
**Trefferkreis:** 12.03 mm  
**Trefferlage:** 1.25 mm links, 0.34 mm tief

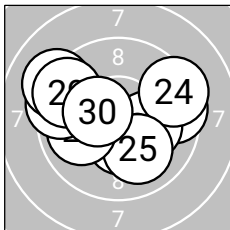

**Serie 3: 97.9 (95)**

10.4* ↘	9.5 ↗	10.2* ↗	9.4 ↗	10.0 ↘
10.0 ↖	9.4 ↖	9.1 ↖	9.5 ↖	10.4* ↖

**beste Teiler:** 136.0 (21.), 142.3 (30.), 193.3 (23.)  
**Trefferkreis:** 12.16 mm  
**Trefferlage:** 0.43 mm links, 0.33 mm hoch

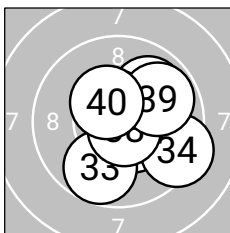

**Serie 4: 102.4 (96)**

10.6* ↘	10.5* ↘	9.8 ↘	9.4 ↘	9.9 ↗
10.7* ↗	10.6* ↗	10.7* ↘	9.8 ↗	10.4* ↖

**beste Teiler:** 60.6 (38.), 61.1 (36.), 86.2 (31.)  
**Trefferkreis:** 10.08 mm  
**Trefferlage:** 0.84 mm rechts, 0.11 mm tief



**Ergebnis: 408.6 (391)**  
**Serien:** 101.7 103.3 102.2 101.4  
**Zähler:** 31 9 0 0 0 0 0 0 0 0  
**Innenzehner:** 26  
**Weiteste:** 440 (10.), 436 (29.), 393 (33.)  
**beste Teiler:** 54.7 (34.), 79.7 (2.), 83.2 (21.)  
**Trefferkreis:** 11.51 mm  
**Trefferlage:** 0.28 mm links, 0.18 mm hoch

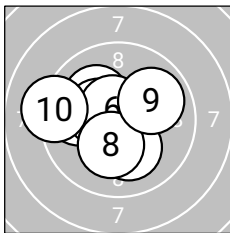
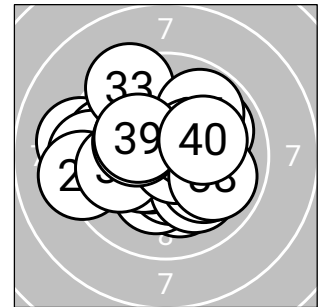

**Serie 1: 101.7 (97)**

10.6*←	10.6*←	9.9←	10.1↖	10.4*←
10.6*↖	10.2*↓	10.2*↓	9.9↗	9.2←

**beste Teiler:** 79.7 (2.), 86.7 (6.), 100.8 (1.)  
**Trefferkreis:** 11.10 mm  
**Trefferlage:** 0.95 mm links, 0.14 mm hoch

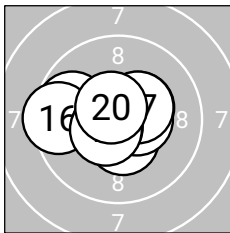

**Serie 2: 103.3 (98)**

10.4*↗	10.6*↖	9.8←	10.4*↓	10.5*↗
9.5←	10.4*↗	10.6*←	10.5*←	10.6*↖

**beste Teiler:** 86.5 (18.), 86.6 (20.), 87.6 (12.)  
**Trefferkreis:** 9.54 mm  
**Trefferlage:** 0.53 mm links, 0.11 mm hoch

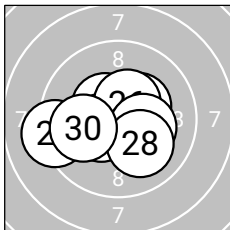

**Serie 3: 102.2 (99)**

10.6*↓	10.3*↗	10.4*←	10.3*↗	10.5*↖
10.5*↗	10.3*↗	10.1↓	9.2←	10.0←

**beste Teiler:** 83.2 (21.), 121.6 (25.), 122.6 (26.)  
**Trefferkreis:** 10.44 mm  
**Trefferlage:** 0.16 mm links, 0.28 mm tief

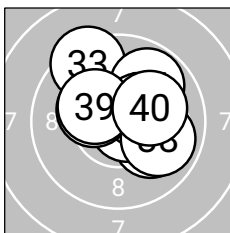

**Serie 4: 101.4 (97)**

10.1↘	10.4*↑	9.4↖	10.7*↗	9.8↗
10.4*↗	10.3*←	9.9↗	10.3*←	10.1↗

**beste Teiler:** 54.7 (34.), 140.1 (32.), 145.8 (36.)  
**Trefferkreis:** 10.69 mm  
**Trefferlage:** 0.51 mm rechts, 0.78 mm hoch



**LG 40 ZR**

StandNr: 137

Erlar, Hubert #70819035

**Senioren\_2m**

Wertung

**StartNr: 222**

01.03.2026 15:24

SG\_Zirl

SG Zirl 2

Ergebnis: **393.5** (376)  
 Serien: 97.1 98.3 99.6 98.5  
 Zähler: 22 12 6 0 0 0 0 0 0 0  
 Innenezehner: 17  
 Weitestе: 652 (13.), 585 (34.), 558 (5.)  
 beste Teiler: 84.3 (17.), 99.0 (38.), 101.0 (18.)  
 Trefferkreis: 15.96 mm  
 Trefferlage: 0.34 mm links, 0.23 mm hoch

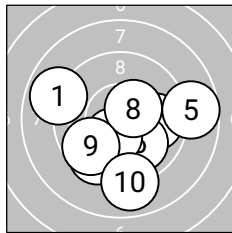
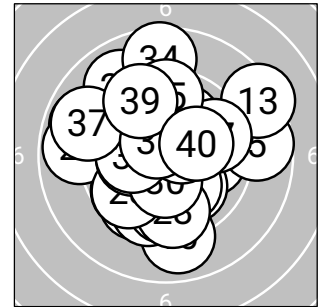
**Serie 1: 97.1** (92)

8.9 ↙	9.6 ↘	10.5* ↘	9.9 →	8.7 →
10.0 ↘	10.4* ↘	10.4* ↗	9.7 ↘	9.0 ↓

beste Teiler: 103.9 (3.), 130.2 (8.), 148.1 (7.)  
 Trefferkreis: 15.11 mm  
 Trefferlage: 0.24 mm rechts, 1.10 mm tief

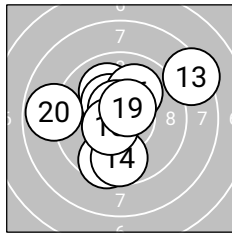
**Serie 2: 98.3** (94)

9.6 ↘	10.0 ↖	8.3 ↗	9.7 ↓	10.3* ↖
10.0 ↗	10.6* ↖	10.5* ↘	10.5* ↗	8.8 ←

beste Teiler: 84.3 (17.), 101.0 (18.), 101.5 (19.)  
 Trefferkreis: 15.73 mm  
 Trefferlage: 0.21 mm links, 0.38 mm hoch

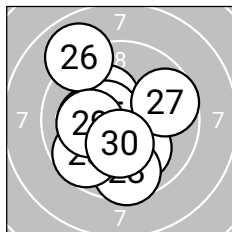
**Serie 3: 99.6** (96)

10.1 ↘	10.3* ↖	9.6 ↓	10.2* ←	10.5* ↖
9.0 ↖	9.7 ↗	9.7 ↘	10.2* ←	10.3* ↓

beste Teiler: 104.1 (25.), 156.0 (30.), 172.5 (22.)  
 Trefferkreis: 12.69 mm  
 Trefferlage: 0.63 mm links, 0.21 mm tief

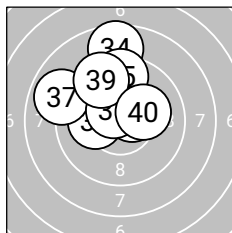
**Serie 4: 98.5** (94)

10.3* ↖	10.1 ←	10.3* ↑	8.6 ↑	9.5 ↑
10.5* ↗	8.9 ↙	10.6* ↖	9.5 ↘	10.2* ↗

beste Teiler: 99.0 (38.), 109.6 (36.), 152.2 (33.)  
 Trefferkreis: 11.58 mm  
 Trefferlage: 0.78 mm links, 1.89 mm hoch

**Ergebnis: 417.3 (400)**  
**Serien:** 103.7 104.7 104.8 104.1  
**Zähler:** 40 0 0 0 0 0 0 0 0 0 0  
**Innenzehner:** 38  
**Weiteste:** 237 (32.), 228 (7.), 194 (33.)  
**beste Teiler:** 35.5 (26.), 44.9 (23.), 55.0 (16.)  
**Trefferkreis:** 8.77 mm  
**Trefferlage:** 0.09 mm rechts, 0.05 mm tief

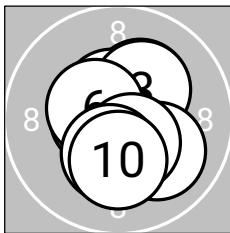
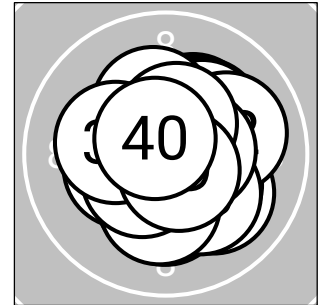

**Serie 1: 103.7 (100)**

10.2*↗	10.5*↖	10.2*↗	10.6*←	10.7*↓
10.5*↖	10.0↘	10.5*↘	10.3*↓	10.2*↓

**beste Teiler:** 55.5 (5.), 90.4 (4.), 104.6 (2.)  
**Trefferkreis:** 8.00 mm  
**Trefferlage:** 0.15 mm rechts, 0.19 mm tief

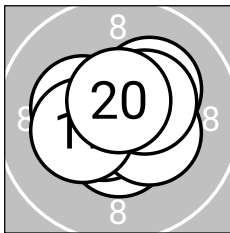

**Serie 2: 104.7 (100)**

10.5*↓	10.2*↗	10.6*↗	10.3*←	10.7*↖
10.7*↗	10.4*↘	10.4*↗	10.3*←	10.6*↑

**beste Teiler:** 55.0 (16.), 75.8 (15.), 81.0 (20.)  
**Trefferkreis:** 7.90 mm  
**Trefferlage:** 0.12 mm rechts, 0.16 mm hoch

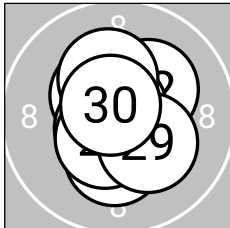

**Serie 3: 104.8 (100)**

10.4*↖	10.2*↗	10.8*←	10.3*↓	10.6*↖
10.8*↑	10.2*↑	10.5*↓	10.3*↘	10.7*↖

**beste Teiler:** 35.5 (26.), 44.9 (23.), 63.5 (30.)  
**Trefferkreis:** 8.05 mm  
**Trefferlage:** 0.08 mm links, 0.03 mm hoch

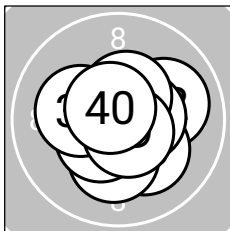

**Serie 4: 104.1 (100)**

10.7*↖	10.0→	10.2*↘	10.2*↓	10.5*↖
10.5*→	10.2*←	10.5*↑	10.6*↘	10.7*↖

**beste Teiler:** 70.4 (40.), 72.1 (31.), 77.4 (39.)  
**Trefferkreis:** 8.69 mm  
**Trefferlage:** 0.16 mm rechts, 0.22 mm tief



Ergebnis: **419.2** (400)  
 Serien: 103.8 105.4 105.2 104.8  
 Zähler: 40 0 0 0 0 0 0 0 0 0 0  
 Innenzehner: 36  
 Weitester: 239 (5.), 237 (39.), 226 (14.)  
 beste Teiler: 9.0 (24.), 11.0 (7.), 13.3 (17.)  
 Trefferkreis: 8.92 mm  
 Trefferlage: 0.00 mm , 0.01 mm tief

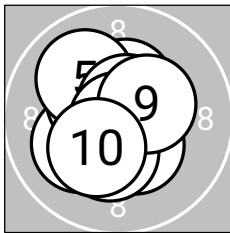
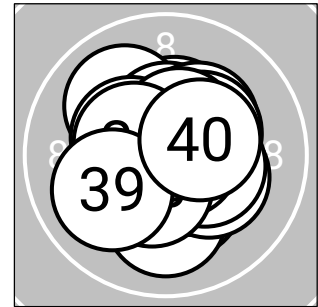

**Serie 1: 103.8** (100)

10.4* ↑	10.1 ↙	10.4* ↖	10.4* ↘	10.0 ↘
10.6* ↗	10.9* ↓	10.3* ↓	10.4* ↗	10.3* ↘

beste Teiler: 11.0 (7.), 79.6 (6.), 135.0 (3.)  
 Trefferkreis: 8.32 mm  
 Trefferlage: 0.29 mm links, 0.02 mm hoch

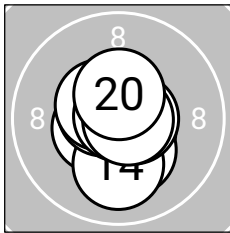

**Serie 2: 105.4** (100)

10.6* ↘	10.3* ↘	10.5* ↙	10.0 ↓	10.6* ↙
10.5* ↖	10.9* ↑	10.7* →	10.8* →	10.5* ↑

beste Teiler: 13.3 (17.), 48.3 (19.), 74.0 (18.)  
 Trefferkreis: 7.96 mm  
 Trefferlage: 0.01 mm links, 0.25 mm tief

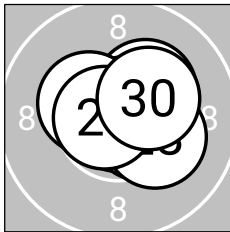

**Serie 3: 105.2** (100)

10.3* ↗	10.3* ↗	10.8* ↖	10.9* ↓	10.8* ↗
10.5* ↘	10.4* ↖	10.2* ↗	10.7* ↖	10.3* ↗

beste Teiler: 9.0 (24.), 33.7 (23.), 50.6 (25.)  
 Trefferkreis: 7.76 mm  
 Trefferlage: 0.42 mm rechts, 0.29 mm hoch

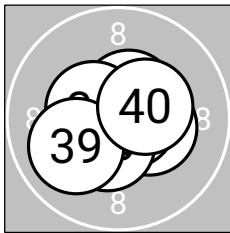

**Serie 4: 104.8** (100)

10.3* →	10.8* →	10.8* →	10.4* ↙	10.5* ↘
10.7* ↑	10.5* ↗	10.4* ↖	10.0 ↙	10.4* →

beste Teiler: 36.6 (32.), 50.4 (33.), 56.7 (36.)  
 Trefferkreis: 8.25 mm  
 Trefferlage: 0.08 mm links, 0.12 mm tief



**Ergebnis: 413.1 (395)**  
**Serien:** 102.4 102.1 104.9 103.7  
**Zähler:** 35 5 0 0 0 0 0 0 0 0  
**Innenzehner:** 28  
**Weiteste:** 346 (9.), 301 (13.), 275 (4.)  
**beste Teiler:** 4.2 (38.), 60.2 (26.), 67.6 (2.)  
**Trefferkreis:** 10.70 mm  
**Trefferlage:** 0.21 mm links, 0.14 mm tief

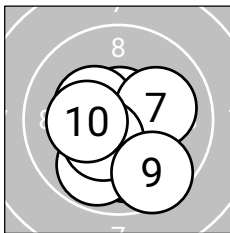
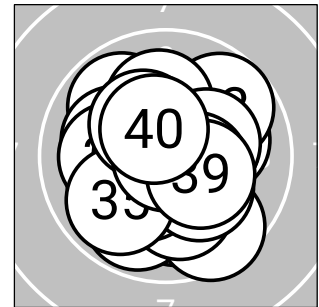

**Serie 1: 102.4 (98)**

10.0↓	10.7*↑	10.4*↖	9.9↙	10.4*↘
10.6*↓	10.1→	10.4*↗	9.6↘	10.3*←

**beste Teiler:** 67.6 (2.), 88.0 (6.), 138.7 (5.)  
**Trefferkreis:** 9.34 mm  
**Trefferlage:** 0.06 mm rechts, 0.86 mm tief

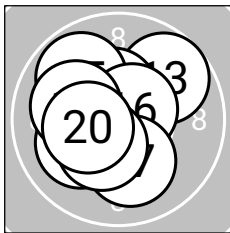

**Serie 2: 102.1 (98)**

10.5*←	10.1↖	9.7↗	10.4*↑	9.9↘
10.6*↗	10.1↓	10.1←	10.4*↗	10.3*←

**beste Teiler:** 84.4 (16.), 121.0 (11.), 131.0 (14.)  
**Trefferkreis:** 9.67 mm  
**Trefferlage:** 0.60 mm links, 0.16 mm hoch

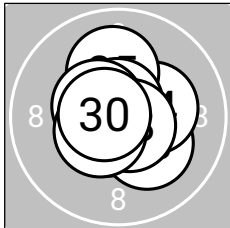

**Serie 3: 104.9 (100)**

10.6*↖	10.6*↖	10.2*↘	10.3*→	10.1↑
10.7*↑	10.5*↖	10.7*↘	10.5*↖	10.7*←

**beste Teiler:** 60.2 (26.), 67.8 (28.), 69.0 (30.)  
**Trefferkreis:** 8.32 mm  
**Trefferlage:** 0.05 mm links, 0.04 mm hoch

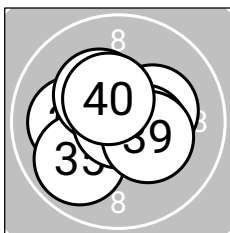

**Serie 4: 103.7 (99)**

10.2*→	10.5*↖	10.1←	10.6*←	9.9↙
10.3*↖	10.4*↘	10.9*↘	10.3*→	10.5*↖

**beste Teiler:** 4.2 (38.), 76.3 (34.), 105.3 (32.)  
**Trefferkreis:** 8.79 mm  
**Trefferlage:** 0.26 mm links, 0.07 mm hoch



**LG 40 ZR**

StandNr: 141

Salchner, Helmut #70819102

**Senioren\_2m**

Wertung

**StartNr: 226**

01.03.2026 15:33

SG\_Matrei\_a.\_Br.

SG Matrei a. Br. 3

Ergebnis: **413.1** (398)  
 Serien: 103.5 104.2 102.4 103.0  
 Zähler: 38 2 0 0 0 0 0 0 0 0  
 Innenzehner: 32  
 Weitest: 349 (26.), 262 (29.), 243 (36.)  
 beste Teiler: 3.1 (17.), 52.4 (12.), 55.9 (20.)  
 Trefferkreis: 10.17 mm  
 Trefferlage: 0.07 mm rechts, 0.07 mm hoch

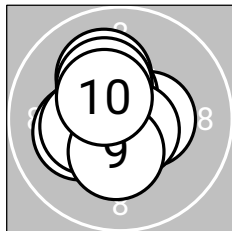
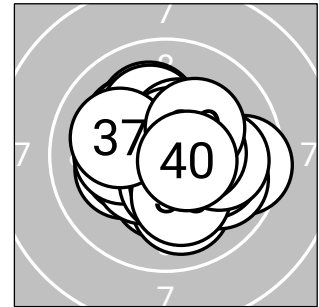
**Serie 1: 103.5** (100)

10.1 ↗	10.2* ↖	10.4* →	10.5* ↖	10.2* ↖
10.3* ↖	10.7* ↘	10.3* ↖	10.3* ↓	10.5* ↖

beste Teiler: 73.5 (7.), 123.5 (4.), 125.8 (10.)  
 Trefferkreis: 8.05 mm  
 Trefferlage: 0.62 mm links, 0.21 mm hoch

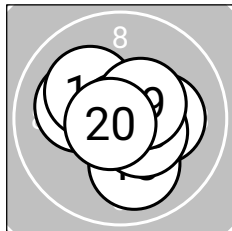
**Serie 2: 104.2** (100)

10.4* ↖	10.7* ↗	10.0 ↓	10.2* →	10.1 ↖
10.2* ↖	10.9* →	10.5* →	10.5* ↗	10.7* ↖

beste Teiler: 3.1 (17.), 52.4 (12.), 55.9 (20.)  
 Trefferkreis: 8.70 mm  
 Trefferlage: 0.03 mm links, 0.04 mm hoch

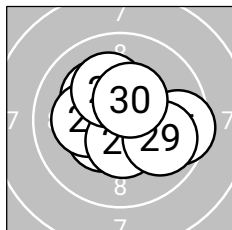
**Serie 3: 102.4** (98)

10.2* ↖	10.5* ↑	10.5* ↖	10.4* ↖	10.2* ↖
9.6 →	10.5* ↓	10.2* ↖	9.9 →	10.4* ↗

beste Teiler: 109.0 (22.), 122.7 (23.), 123.9 (27.)  
 Trefferkreis: 9.90 mm  
 Trefferlage: 0.06 mm rechts, 0.26 mm hoch

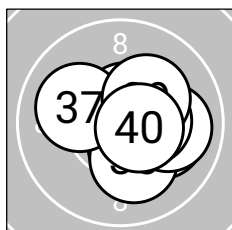
**Serie 4: 103.0** (100)

10.4* ↘	10.1 →	10.6* ↑	10.4* ↓	10.2* ↓
10.0 →	10.1 ↖	10.4* →	10.2* ↗	10.6* →

beste Teiler: 84.4 (33.), 100.4 (40.), 137.2 (34.)  
 Trefferkreis: 9.10 mm  
 Trefferlage: 0.88 mm rechts, 0.21 mm tief

Ergebnis: **411.8 (391)**  
 Serien: 102.6 103.5 103.2 102.5  
 Zähler: 31 9 0 0 0 0 0 0 0 0  
 Innenzehner: 28  
 Weitester: 409 (21.), 361 (39.), 351 (37.)  
 beste Teiler: 15.6 (24.), 19.2 (28.), 22.0 (14.)  
 Trefferkreis: 11.72 mm  
 Trefferlage: 0.19 mm rechts, 0.59 mm tief

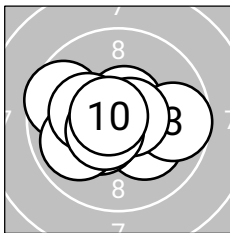
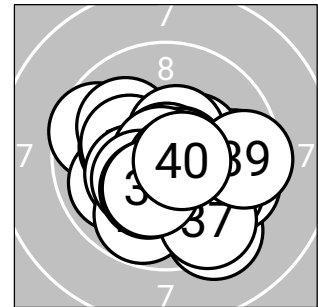

**Serie 1: 102.6 (97)**

10.2*↘	10.6*↗	9.7→	10.7*↗	9.6↖
10.4*↙	9.9↖	10.2*↖	10.6*↙	10.7*↖

beste Teiler: 58.8 (10.), 68.6 (4.), 89.6 (2.)  
 Trefferkreis: 10.91 mm  
 Trefferlage: 0.38 mm links, 0.13 mm tief

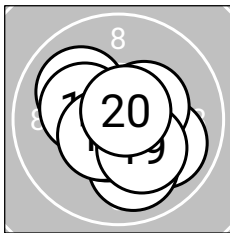

**Serie 2: 103.5 (100)**

10.0↖	10.0↘	10.4*↗	10.9*↓	10.0↘
10.6*↙	10.2*↖	10.5*↙	10.2*↘	10.7*↗

beste Teiler: 22.0 (14.), 55.9 (20.), 99.2 (16.)  
 Trefferkreis: 9.28 mm  
 Trefferlage: 0.08 mm rechts, 0.37 mm tief

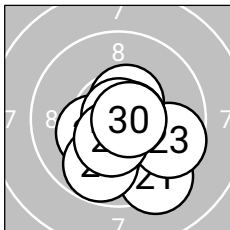

**Serie 3: 103.2 (97)**

9.3↘	10.3*↖	9.6↘	10.9*↗	9.8↘
10.5*↗	10.7*↗	10.9*↑	10.5*↙	10.7*↗

beste Teiler: 15.6 (24.), 19.2 (28.), 60.0 (27.)  
 Trefferkreis: 9.38 mm  
 Trefferlage: 0.41 mm rechts, 0.81 mm tief

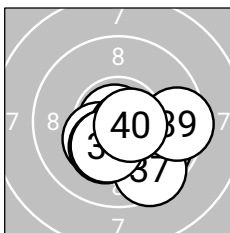

**Serie 4: 102.5 (97)**

10.9*↖	10.5*↘	10.3*↙	9.9↘	10.7*↘
10.3*↙	9.5↘	10.3*↙	9.5→	10.6*↗

beste Teiler: 22.2 (31.), 64.3 (35.), 78.1 (40.)  
 Trefferkreis: 9.38 mm  
 Trefferlage: 0.66 mm rechts, 1.04 mm tief



**LG 40 ZR**

StandNr: 143

Eller, Herbert #70819098

**Senioren\_2m**

Wertung

**StartNr: 228**

01.03.2026 15:29

SG\_Matrei\_a.\_Br.

SG Matrei a. Br. 1

Ergebnis: **417.2 (399)**  
 Serien: 103.2 104.6 105.5 103.9  
 Zähler: 39 1 0 0 0 0 0 0 0 0  
 Innenzehner: 35  
 Weitestе: 283 (8.), 246 (40.), 240 (38.)  
 beste Teiler: 32.0 (17.), 32.8 (2.), 35.3 (19.)  
 Trefferkreis: 9.66 mm  
 Trefferlage: 0.13 mm rechts, 0.37 mm hoch

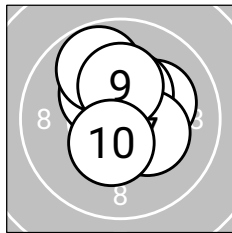
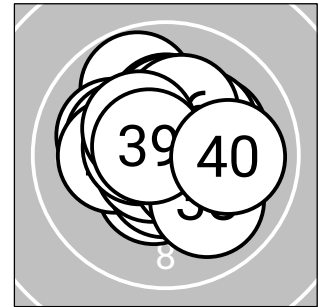
**Serie 1: 103.2 (99)**

10.2*↗	10.8*↖	10.5*↘	10.2*↖	10.3*↖
10.4*↗	10.3*↘	9.8↖	10.3*↖	10.4*↘

beste Teiler: 32.8 (2.), 122.2 (3.), 134.4 (10.)  
 Trefferkreis: 8.71 mm  
 Trefferlage: 0.16 mm rechts, 0.73 mm hoch

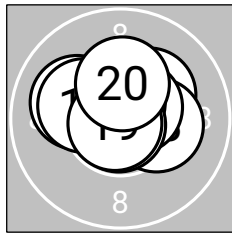
**Serie 2: 104.6 (100)**

10.2*↗	10.6*↗	10.3*↘	10.6*↗	10.1↖
10.7*↖	10.8*↘	10.2*↖	10.8*↖	10.3*↖

beste Teiler: 32.0 (17.), 35.3 (19.), 75.6 (16.)  
 Trefferkreis: 8.45 mm  
 Trefferlage: 0.02 mm rechts, 0.52 mm hoch

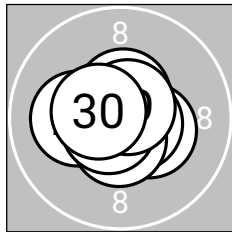
**Serie 3: 105.5 (100)**

10.4*↘	10.6*↖	10.7*↖	10.5*↖	10.7*↘
10.1↖	10.6*↘	10.7*↖	10.7*↗	10.5*↖

beste Teiler: 62.6 (29.), 63.6 (23.), 66.8 (28.)  
 Trefferkreis: 7.92 mm  
 Trefferlage: 0.21 mm links, 0.05 mm hoch

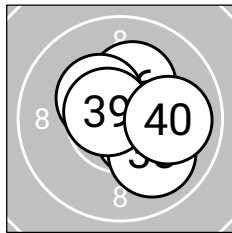
**Serie 4: 103.9 (100)**

10.3*↘	10.5*↘	10.7*↖	10.5*↖	10.6*↗
10.2*↖	10.4*↖	10.0↘	10.7*↖	10.0↘

beste Teiler: 62.6 (33.), 74.7 (39.), 85.9 (35.)  
 Trefferkreis: 8.44 mm  
 Trefferlage: 0.55 mm rechts, 0.18 mm hoch

Ergebnis: **408.5** (395)  
 Serien: 101.3 101.4 102.3 103.5  
 Zähler: 35 5 0 0 0 0 0 0 0 0 0  
 Innenzehner: 25  
 Weitest: 386 (5.), 356 (29.), 326 (17.)  
 beste Teiler: 61.8 (25.), 81.3 (27.), 96.1 (31.)  
 Trefferkreis: 10.91 mm  
 Trefferlage: 0.18 mm rechts, 0.12 mm hoch

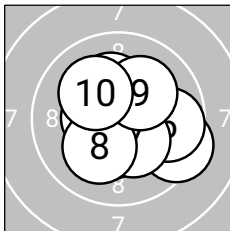
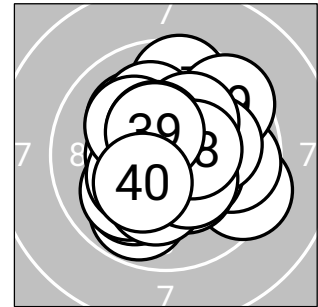

**Serie 1: 101.3** (98)

10.2\*↑ 10.5\*↙ 10.4\*↓ 10.5\*← 9.4→  
 9.7→ 10.3\*↘ 10.1↙ 10.1↗ 10.1↘

beste Teiler: 110.5 (2.), 123.1 (4.), 145.4 (3.)  
 Trefferkreis: 10.33 mm  
 Trefferlage: 0.33 mm rechts, 0.21 mm tief

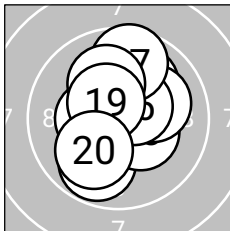

**Serie 2: 101.4** (98)

10.0↗ 9.8↙ 10.4\*↘ 10.1↗ 10.4\*←  
 10.5\*↗ 9.6↑ 10.1↑ 10.5\*↘ 10.0↙

beste Teiler: 114.6 (16.), 117.0 (19.), 142.0 (15.)  
 Trefferkreis: 10.52 mm  
 Trefferlage: 0.05 mm rechts, 0.45 mm hoch

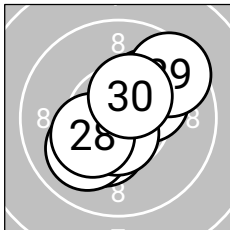

**Serie 3: 102.3** (99)

10.2\*↙ 10.1↗ 10.3\*↙ 10.0↙ 10.7\*↗  
 10.2\*↗ 10.6\*↓ 10.3\*↙ 9.5↗ 10.4\*↗

beste Teiler: 61.8 (25.), 81.3 (27.), 134.2 (30.)  
 Trefferkreis: 10.38 mm  
 Trefferlage: 0.18 mm rechts, 0.00 mm

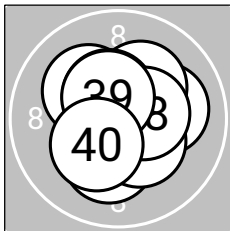

**Serie 4: 103.5** (100)

10.6\*↑ 10.2\*↘ 10.2\*↓ 10.1↗ 10.4\*↘  
 10.2\*↗ 10.5\*↘ 10.5\*↗ 10.5\*↘ 10.3\*↙

beste Teiler: 96.1 (31.), 116.2 (39.), 120.5 (37.)  
 Trefferkreis: 8.55 mm  
 Trefferlage: 0.15 mm rechts, 0.25 mm hoch



**LG 40 ZR**

StandNr: 146

**Helgert, Hans-Maximilian** #70819236**Senioren\_2m**

Wertung

**StartNr: 231**

01.03.2026 15:33

SG\_Eben

SG Eben 2

Ergebnis: **413.6** (394)  
 Serien: 101.8 103.8 103.2 104.8  
 Zähler: 34 6 0 0 0 0 0 0 0 0 0  
 Innenzehner: 30  
 Weitester: 427 (2.), 359 (35.), 332 (21.)  
 beste Teiler: 22.5 (36.), 24.0 (5.), 35.0 (31.)  
 Trefferkreis: 12.34 mm  
 Trefferlage: 0.15 mm links, 0.04 mm hoch

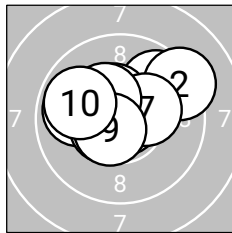
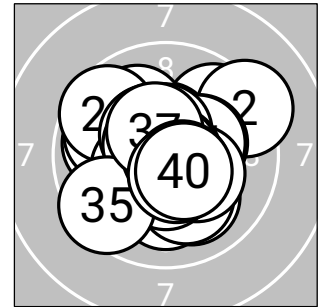
**Serie 1: 101.8** (96)

9.8 ↗	9.2 ↗	9.9 ←	10.4* ↖	10.9* →
10.5* ↙	10.3* →	10.3* ↘	10.6* ↙	9.9 ↙

beste Teiler: 24.0 (5.), 91.2 (9.), 103.3 (6.)  
 Trefferkreis: 10.97 mm  
 Trefferlage: 0.03 mm links, 0.75 mm hoch

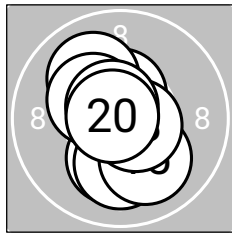
**Serie 2: 103.8** (100)

10.5* ↑	10.2* ↓	10.6* ↓	10.1 ↓	10.0 ↓
10.0 ↘	10.3* ↘	10.6* →	10.7* ↘	10.8* ↙

beste Teiler: 40.5 (20.), 71.0 (19.), 81.9 (18.)  
 Trefferkreis: 9.12 mm  
 Trefferlage: 0.14 mm links, 0.25 mm tief

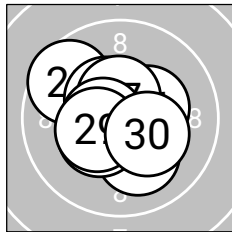
**Serie 3: 103.2** (99)

9.6 ↙	10.1 ↓	10.4* ↘	10.4* ↙	10.6* →
10.3* →	10.5* ↑	10.6* ←	10.4* ↙	10.3* ↘

beste Teiler: 78.1 (25.), 93.5 (28.), 108.3 (27.)  
 Trefferkreis: 9.77 mm  
 Trefferlage: 0.22 mm links, 0.02 mm hoch

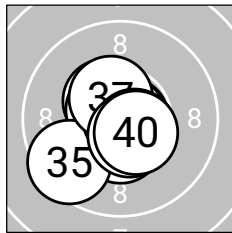
**Serie 4: 104.8** (99)

10.8* →	10.4* ↘	10.5* ↓	10.6* ↘	9.5 ↙
10.9* →	10.5* ↘	10.6* ↘	10.5* ↓	10.5* ↘

beste Teiler: 22.5 (36.), 35.0 (31.), 83.8 (34.)  
 Trefferkreis: 8.70 mm  
 Trefferlage: 0.20 mm links, 0.32 mm tief

**Ergebnis: 412.7 (396)**  
**Serien:** 103.5 103.0 103.4 102.8  
**Zähler:** 36 4 0 0 0 0 0 0 0 0  
**Innenzehner:** 26  
**Weiteste:** 287 (9.), 258 (1.), 258 (32.)  
**beste Teiler:** 29.0 (8.), 31.4 (7.), 58.5 (5.)  
**Trefferkreis:** 9.94 mm  
**Trefferlage:** 0.08 mm rechts, 0.30 mm hoch

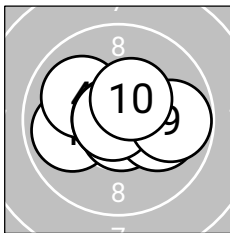
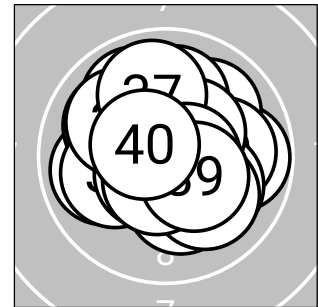

**Serie 1: 103.5 (98)**

9.9 ←	10.4* ↖	10.6* ↖	10.0 ↖	10.7* ↓
10.1 →	10.8* ←	10.8* ←	9.8 →	10.4* ↗

**beste Teiler:** 29.0 (8.), 31.4 (7.), 58.5 (5.)  
**Trefferkreis:** 9.92 mm  
**Trefferlage:** 0.09 mm links, 0.20 mm hoch

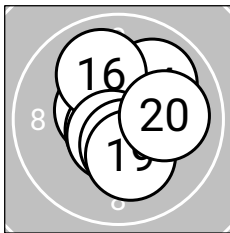

**Serie 2: 103.0 (100)**

10.3* →	10.5* ↖	10.3* →	10.0 ↗	10.7* ↖
10.0 ↗	10.6* ↓	10.4* ↓	10.2* ↓	10.0 →

**beste Teiler:** 67.0 (15.), 86.1 (17.), 104.6 (12.)  
**Trefferkreis:** 8.82 mm  
**Trefferlage:** 0.56 mm rechts, 0.14 mm hoch

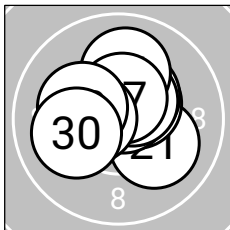

**Serie 3: 103.4 (100)**

10.1 →	10.5* ↗	10.4* ↗	10.7* ↗	10.5* ↗
10.0 ↑	10.5* ↑	10.4* ←	10.2* ←	10.1 ←

**beste Teiler:** 60.8 (24.), 105.7 (27.), 115.2 (25.)  
**Trefferkreis:** 8.96 mm  
**Trefferlage:** 0.01 mm links, 0.54 mm hoch

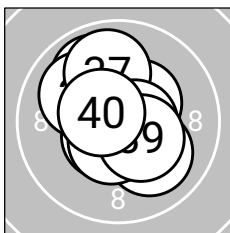

**Serie 4: 102.8 (98)**

10.0 ↘	9.9 ↖	10.4* ↗	10.5* ↖	10.5* ↓
10.0 ↖	9.9 ↑	10.6* →	10.4* ↘	10.6* ↖

**beste Teiler:** 84.3 (38.), 98.8 (40.), 101.8 (34.)  
**Trefferkreis:** 9.31 mm  
**Trefferlage:** 0.09 mm links, 0.33 mm hoch



**Ergebnis: 412.0 (395)**  
**Serien:** 103.5 102.2 103.2 103.1  
**Zähler:** 35 5 0 0 0 0 0 0 0 0  
**Innenzehner:** 27  
**Weiteste:** 331 (35.), 328 (25.), 299 (13.)  
**beste Teiler:** 44.9 (29.), 68.0 (31.), 70.8 (5.)  
**Trefferkreis:** 10.93 mm  
**Trefferlage:** 0.07 mm links, 0.05 mm tief

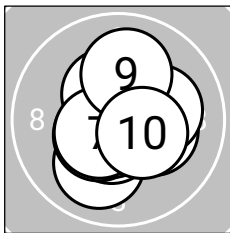
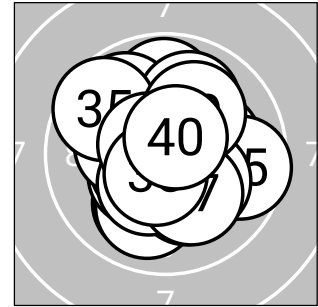

**Serie 1: 103.5 (100)**

10.0 ↘	10.6* ↘	10.2* ➡	10.5* ↙	10.7* ↘
10.4* ↗	10.5* ↙	10.2* ➡	10.0 ↑	10.4* ➡

**beste Teiler:** 70.8 (5.), 95.8 (2.), 112.0 (7.)  
**Trefferkreis:** 9.07 mm  
**Trefferlage:** 0.11 mm rechts, 0.22 mm tief

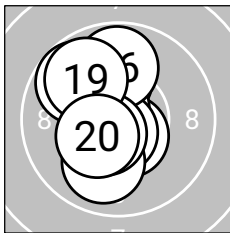

**Serie 2: 102.2 (97)**

10.1 ↑	10.5* ↘	9.8 ↘	10.6* ↘	10.7* ↓
9.8 ↑	10.0 ↘	10.5* ↙	9.8 ↘	10.4* ↙

**beste Teiler:** 71.8 (15.), 83.4 (14.), 102.0 (12.)  
**Trefferkreis:** 9.64 mm  
**Trefferlage:** 0.73 mm links, 0.40 mm hoch

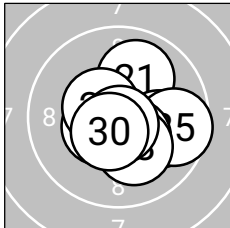

**Serie 3: 103.2 (99)**

10.0 ↗	10.6* ↙	10.0 ➡	10.5* ↙	9.6 ➡
10.4* ↘	10.5* ↙	10.2* ↘	10.8* ↓	10.6* ↙

**beste Teiler:** 44.9 (29.), 90.4 (22.), 99.1 (30.)  
**Trefferkreis:** 8.93 mm  
**Trefferlage:** 0.50 mm rechts, 0.37 mm tief

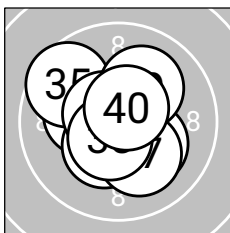

**Serie 4: 103.1 (99)**

10.7* ↘	10.2* ↙	10.2* ➡	10.4* ↙	9.6 ↙
10.6* ↙	10.1 ↘	10.6* ↘	10.1 ↗	10.6* ↗

**beste Teiler:** 68.0 (31.), 83.3 (36.), 84.7 (40.)  
**Trefferkreis:** 9.77 mm  
**Trefferlage:** 0.16 mm links, 0.02 mm tief



**Ergebnis: 412.5 (397)**  
**Serien:** 102.8 102.1 105.5 102.1  
**Zähler:** 37 3 0 0 0 0 0 0 0 0  
**Innenzehner:** 29  
**Weiteste:** 437 (3.), 331 (19.), 291 (16.)  
**beste Teiler:** 24.1 (21.), 45.1 (26.), 58.0 (6.)  
**Trefferkreis:** 10.88 mm  
**Trefferlage:** 0.17 mm rechts, 0.42 mm tief

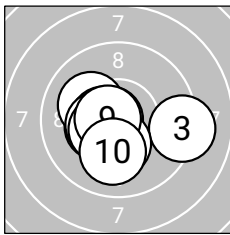
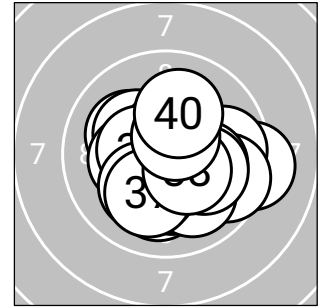

**Serie 1: 102.8 (99)**

10.4*←	10.1↖	9.2→	10.5*←	10.4*←
10.7*←	10.4*←	10.3*↓	10.7*←	10.1↓

**beste Teiler:** 58.0 (6.), 72.3 (9.), 101.0 (4.)  
**Trefferkreis:** 10.88 mm  
**Trefferlage:** 0.41 mm links, 0.47 mm tief

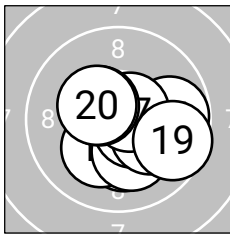

**Serie 2: 102.1 (98)**

10.2*↓	10.2*↙	10.2*↓	10.6*↘	10.1↘
9.8→	10.6*↗	10.4*↖	9.6→	10.4*↖

**beste Teiler:** 76.8 (17.), 97.7 (14.), 132.6 (18.)  
**Trefferkreis:** 9.26 mm  
**Trefferlage:** 0.70 mm rechts, 0.56 mm tief

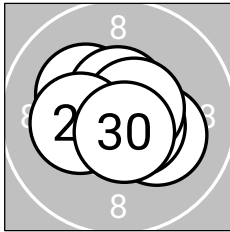

**Serie 3: 105.5 (100)**

10.9*↖	10.6*↘	10.2*↘	10.6*↘	10.2*↖
10.8*←	10.6*↑	10.6*↗	10.3*←	10.7*↓

**beste Teiler:** 24.1 (21.), 45.1 (26.), 73.1 (30.)  
**Trefferkreis:** 8.17 mm  
**Trefferlage:** 0.04 mm rechts, 0.03 mm tief

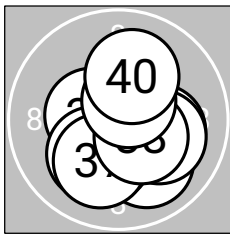

**Serie 4: 102.1 (100)**

10.4*←	10.2*↘	10.0↘	10.2*↓	10.1↘
10.1→	10.1↓	10.4*↘	10.5*↗	10.1↑

**beste Teiler:** 103.8 (39.), 128.7 (31.), 136.4 (38.)  
**Trefferkreis:** 8.87 mm  
**Trefferlage:** 0.35 mm rechts, 0.62 mm tief



Ergebnis: **415.3 (397)**  
 Serien: 102.9 102.5 106.1 103.8  
 Zähler: 37 3 0 0 0 0 0 0 0 0  
 Innenzehner: 34  
 Weitester: 337 (9.), 321 (3.), 251 (16.)  
 beste Teiler: 38.4 (37.), 38.9 (29.), 45.8 (5.)  
 Trefferkreis: 10.21 mm  
 Trefferlage: 0.25 mm links, 0.05 mm tief

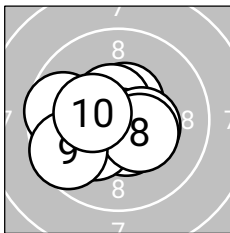
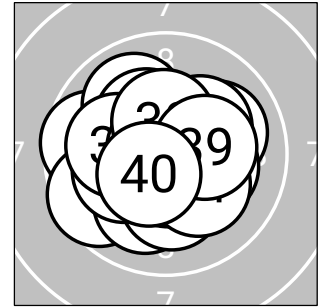

**Serie 1: 102.9 (98)**

10.5*↑	10.5*↖	9.7←	10.5*↓	10.8*↓
10.2*↙	10.4*↗	10.4*↗	9.6↙	10.3*↖

beste Teiler: 45.8 (5.), 102.3 (2.), 108.2 (4.)  
 Trefferkreis: 9.17 mm  
 Trefferlage: 0.58 mm links, 0.27 mm tief

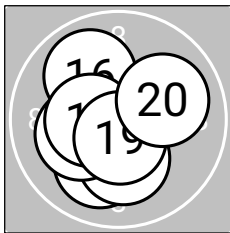

**Serie 2: 102.5 (99)**

10.5*↖	10.2*↓	10.1↓	10.4*↙	10.2*↓
9.9↖	10.2*↖	10.4*↖	10.6*↓	10.0↗

beste Teiler: 90.4 (19.), 112.6 (11.), 133.0 (18.)  
 Trefferkreis: 9.20 mm  
 Trefferlage: 0.57 mm links, 0.54 mm tief

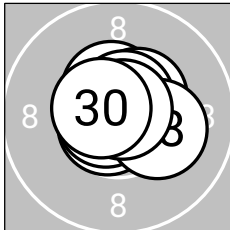

**Serie 3: 106.1 (100)**

10.5*↑	10.5*↗	10.8*↖	10.6*↗	10.7*↙
10.7*↖	10.7*↖	10.2*↗	10.8*↗	10.6*↖

beste Teiler: 38.9 (29.), 49.3 (23.), 56.0 (27.)  
 Trefferkreis: 7.24 mm  
 Trefferlage: 0.00 mm, 0.27 mm hoch

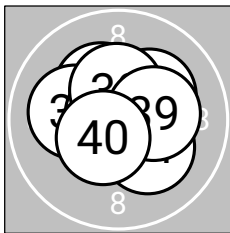

**Serie 4: 103.8 (100)**

10.5*↑	10.3*↖	10.5*↗	10.2*↗	10.1←
10.2*↗	10.8*↖	10.4*↑	10.3*↗	10.5*↙

beste Teiler: 38.4 (37.), 103.0 (31.), 108.4 (33.)  
 Trefferkreis: 8.49 mm  
 Trefferlage: 0.14 mm rechts, 0.31 mm hoch



Ergebnis: **414.3** (398)  
 Serien: 104.0 103.2 103.6 103.5  
 Zähler: 38 2 0 0 0 0 0 0 0 0  
 Innenzehner: 34  
 Weitester: 420 (18.), 336 (27.), 243 (35.)  
 beste Teiler: 58.3 (1.), 61.4 (39.), 74.3 (38.)  
 Trefferkreis: 10.62 mm  
 Trefferlage: 0.16 mm links, 0.18 mm tief

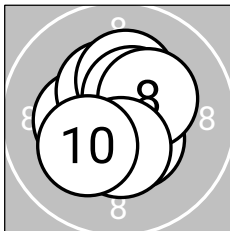
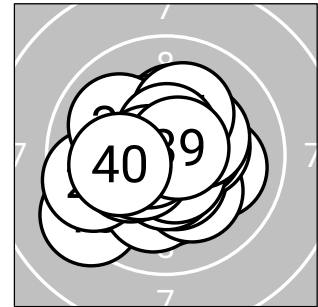

**Serie 1: 104.0** (100)

10.7*↘	10.5*↘	10.3*←	10.5*↘	10.4*↖
10.2*↑	10.5*↗	10.3*↗	10.4*↓	10.2*↙

beste Teiler: 58.3 (1.), 105.8 (2.), 115.8 (4.)  
 Trefferkreis: 7.98 mm  
 Trefferlage: 0.06 mm rechts, 0.02 mm hoch

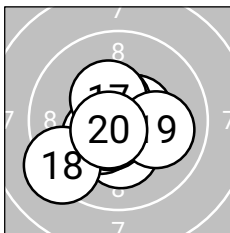

**Serie 2: 103.2** (99)

10.6*↗	10.3*↓	10.4*↙	10.6*↙	10.5*↗
10.5*↖	10.4*↖	9.3↙	10.0→	10.6*↙

beste Teiler: 79.1 (20.), 83.4 (14.), 85.1 (11.)  
 Trefferkreis: 10.38 mm  
 Trefferlage: 0.22 mm links, 0.38 mm tief

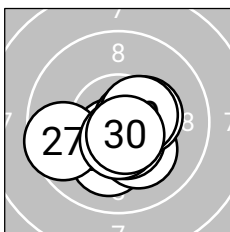

**Serie 3: 103.6** (99)

10.6*↙	10.6*→	10.1↓	10.2*↘	10.5*↘
10.4*→	9.6←	10.5*↓	10.5*→	10.6*↘

beste Teiler: 81.0 (22.), 83.2 (30.), 95.6 (21.)  
 Trefferkreis: 9.37 mm  
 Trefferlage: 0.13 mm rechts, 0.75 mm tief

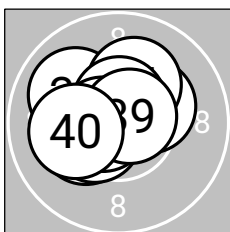

**Serie 4: 103.5** (100)

10.3*←	10.2*←	10.3*↗	10.4*←	10.0↖
10.2*↗	10.6*↑	10.7*←	10.7*↗	10.1←

beste Teiler: 61.4 (39.), 74.3 (38.), 90.1 (37.)  
 Trefferkreis: 8.21 mm  
 Trefferlage: 0.64 mm links, 0.37 mm hoch

**LG 40 ZR**

StandNr: 104

Felderer, Raimund #70818590

**Senioren\_2m**

Wertung

**StartNr: 237**

01.03.2026 17:04

SG\_Breitenbach

SG Breitenbach 1

Ergebnis: **419.3** (400)  
 Serien: 105.5 104.4 105.2 104.2  
 Zähler: 40 0 0 0 0 0 0 0 0 0 0  
 Innenzehner: 38  
 Weitester: 249 (2.), 241 (18.), 197 (40.)  
 beste Teiler: 22.4 (32.), 28.4 (8.), 48.2 (22.)  
 Trefferkreis: 9.26 mm  
 Trefferlage: 0.08 mm rechts, 0.21 mm tief

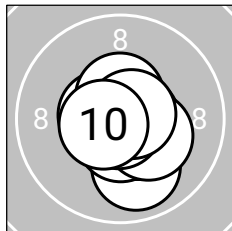
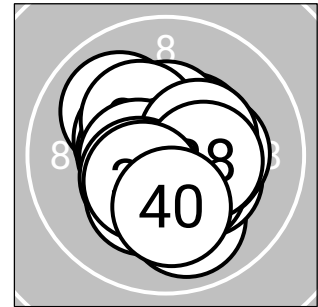
**Serie 1: 105.5** (100)

10.7\*← 10.0↓ 10.6\*↓ 10.6\*← 10.7\*→  
 10.5\*↑ 10.3\*↘ 10.8\*↓ 10.7\*→ 10.6\*←

beste Teiler: 28.4 (8.), 60.9 (9.), 65.2 (1.)  
 Trefferkreis: 8.04 mm  
 Trefferlage: 0.10 mm rechts, 0.31 mm tief

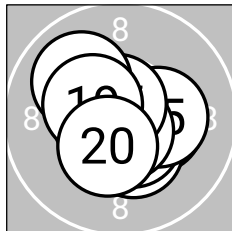
**Serie 2: 104.4** (100)

10.3\*→ 10.6\*← 10.4\*↓ 10.6\*↓ 10.3\*→  
 10.7\*↓ 10.7\*↑ 10.0↖ 10.4\*← 10.4\*↓

beste Teiler: 57.0 (16.), 67.4 (17.), 76.6 (12.)  
 Trefferkreis: 8.41 mm  
 Trefferlage: 0.00 mm, 0.13 mm tief

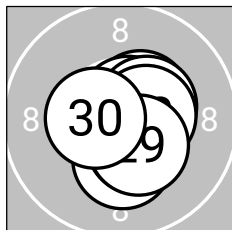
**Serie 3: 105.2** (100)

10.5\*↗ 10.8\*← 10.7\*→ 10.7\*↗ 10.4\*→  
 10.3\*↓ 10.4\*↓ 10.5\*→ 10.4\*↓ 10.5\*←

beste Teiler: 48.2 (22.), 69.8 (23.), 71.6 (24.)  
 Trefferkreis: 7.29 mm  
 Trefferlage: 0.43 mm rechts, 0.16 mm tief

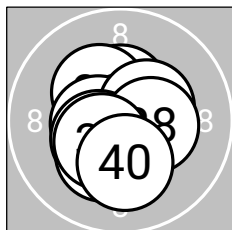
**Serie 4: 104.2** (100)

10.4\*↑ 10.9\*← 10.3\*↖ 10.5\*← 10.4\*→  
 10.4\*↖ 10.3\*↓ 10.4\*→ 10.4\*↖ 10.2\*↓

beste Teiler: 22.4 (32.), 104.9 (34.), 131.0 (31.)  
 Trefferkreis: 8.01 mm  
 Trefferlage: 0.20 mm links, 0.24 mm tief

**Ergebnis: 406.9 (390)**  
**Serien: 98.9 101.4 103.7 102.9**  
**Zähler: 30 10 0 0 0 0 0 0 0 0**  
**Innenzehner: 26**  
**Weiteste: 499 (9.), 446 (6.), 411 (11.)**  
**beste Teiler: 39.2 (21.), 64.0 (2.), 76.6 (29.)**  
**Trefferkreis: 12.16 mm**  
**Trefferlage: 0.20 mm links, 0.70 mm hoch**

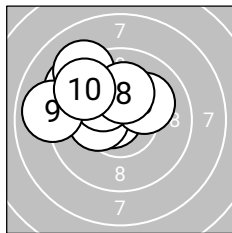
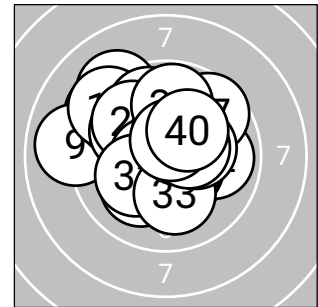

**Serie 1: 98.9 (96)**

9.3 ↖	10.7* ↖	10.3* ↑	10.3* ↖	10.1 ↗
9.2 ↖	10.2* ↖	10.2* ↑	9.0 ↖	9.6 ↖
beste Teiler: 64.0 (2.), 151.2 (3.), 162.0 (4.)				
Trefferkreis: 11.25 mm				
Trefferlage: 1.53 mm links, 1.49 mm hoch				

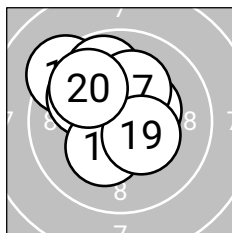

**Serie 2: 101.4 (97)**

9.3 ↖	10.0 ↖	10.6* ↗	9.8 ↑	10.5* ↗
10.4* ↗	10.2* ↑	10.3* ↘	10.4* ↘	9.9 ↖
beste Teiler: 90.7 (13.), 115.4 (15.), 139.9 (16.)				
Trefferkreis: 10.03 mm				
Trefferlage: 0.39 mm links, 0.99 mm hoch				

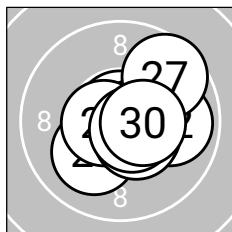

**Serie 3: 103.7 (98)**

10.8* ↑	9.9 →	10.6* →	10.5* ↘	10.1 ↘
10.6* ↖	9.6 ↗	10.5* ↘	10.6* ↘	10.5* →
beste Teiler: 39.2 (21.), 76.6 (29.), 84.0 (23.)				
Trefferkreis: 9.92 mm				
Trefferlage: 0.71 mm rechts, 0.12 mm tief				

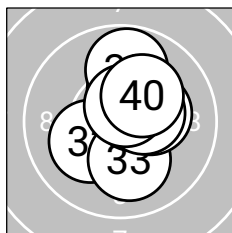

**Serie 4: 102.9 (99)**

10.5* ↘	10.2* ↖	10.1 ↓	10.2* ↑	9.8 ↑
10.6* ↗	10.3* →	10.4* →	10.6* ↑	10.2* ↗
beste Teiler: 92.3 (39.), 96.2 (36.), 113.4 (31.)				
Trefferkreis: 9.39 mm				
Trefferlage: 0.41 mm rechts, 0.43 mm hoch				



Ergebnis: **409.7** (391)  
 Serien: 102.5 102.6 102.3 102.3  
 Zähler: 31 9 0 0 0 0 0 0 0 0 0  
 Innenzehner: 23  
 Weitester: 366 (12.), 296 (8.), 291 (17.)  
 beste Teiler: 6.4 (14.), 17.0 (9.), 54.7 (1.)  
 Trefferkreis: 10.98 mm  
 Trefferlage: 0.38 mm links, 0.05 mm hoch

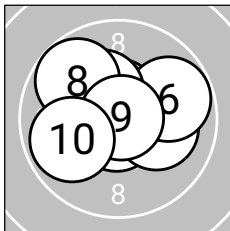
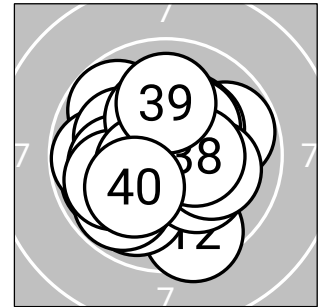

**Serie 1: 102.5** (96)  
 10.7\*↓      10.1→      9.9↖      10.6\*↑      10.5\*↖  
 9.8→      10.3\*↖      9.8↖      10.9\*→      9.9↖  
 beste Teiler: 17.0 (9.), 54.7 (1.), 96.1 (4.)  
 Trefferkreis: 10.09 mm  
 Trefferlage: 0.31 mm links, 0.61 mm hoch

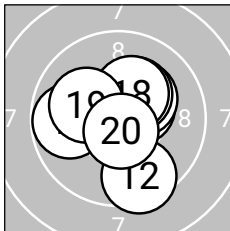

**Serie 2: 102.6** (98)  
 10.4\*↗      9.5↓      10.3\*↗      10.9\*↗      10.3\*↗  
 10.4\*↖      9.8←      10.3\*↗      10.1↖      10.6\*↓  
 beste Teiler: 6.4 (14.), 77.6 (20.), 127.1 (16.)  
 Trefferkreis: 10.12 mm  
 Trefferlage: 0.03 mm links, 0.16 mm hoch

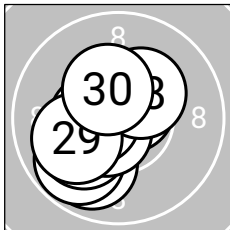

**Serie 3: 102.3** (98)  
 9.9↙      10.2\*↖      10.6\*↗      9.8↙      10.1↖  
 10.6\*↙      10.5\*←      10.3\*↗      10.0↖      10.3\*↖  
 beste Teiler: 77.0 (23.), 86.3 (26.), 117.0 (27.)  
 Trefferkreis: 8.98 mm  
 Trefferlage: 0.93 mm links, 0.48 mm tief

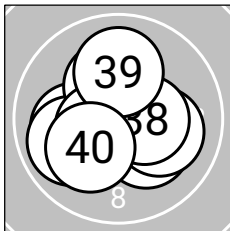

**Serie 4: 102.3** (99)  
 10.7\*↑      10.1←      10.2\*↘      10.1→      9.9↖  
 10.3\*↑      10.5\*↖      10.4\*→      10.0↑      10.1↖  
 beste Teiler: 60.0 (31.), 103.3 (37.), 132.0 (38.)  
 Trefferkreis: 9.25 mm  
 Trefferlage: 0.25 mm links, 0.08 mm tief



Ergebnis: **410.2** (392)  
 Serien: 104.2 102.9 101.2 101.9  
 Zähler: 32 8 0 0 0 0 0 0 0 0 0  
 Innenzehner: 27  
 Weitestе: 479 (40.), 353 (29.), 313 (14.)  
 beste Teiler: 29.1 (32.), 30.2 (26.), 47.0 (10.)  
 Trefferkreis: 12.57 mm  
 Trefferlage: 0.28 mm rechts, 0.16 mm tief

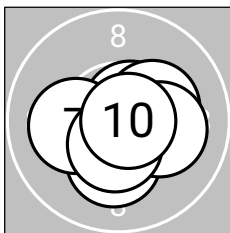
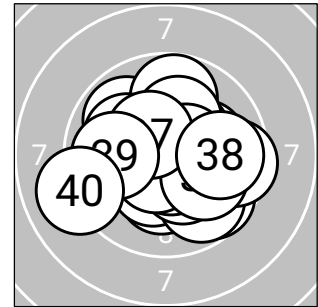

**Serie 1: 104.2** (100)

10.5*↓	10.5*↖	10.6*↗	10.3*→	10.5*↖
10.2*↓	10.1←	10.2*→	10.5*↓	10.8*→

beste Teiler: 47.0 (10.), 81.3 (3.), 104.1 (5.)  
 Trefferkreis: 8.45 mm  
 Trefferlage: 0.07 mm rechts, 0.48 mm tief

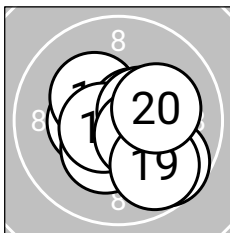

**Serie 2: 102.9** (98)

10.4*←	10.3*↖	10.6*↗	9.7↘	10.3*↖
10.6*↖	10.5*↗	10.5*↘	9.8↘	10.2*→

beste Teiler: 82.2 (16.), 89.8 (13.), 125.3 (17.)  
 Trefferkreis: 9.32 mm  
 Trefferlage: 0.51 mm rechts, 0.42 mm tief

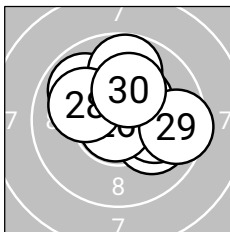

**Serie 3: 101.2** (97)

10.0↘	9.9↖	10.5*↗	10.1→	10.3*↗
10.8*↖	9.8↑	10.1←	9.5→	10.2*↗

beste Teiler: 30.2 (26.), 109.7 (23.), 152.0 (25.)  
 Trefferkreis: 10.45 mm  
 Trefferlage: 0.66 mm rechts, 0.70 mm hoch

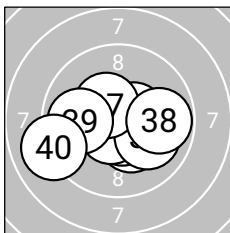

**Serie 4: 101.9** (97)

10.3*↘	10.8*↘	10.6*↓	10.5*→	10.6*↖
10.0↘	10.4*↖	9.8→	9.9←	9.0←

beste Teiler: 29.1 (32.), 87.5 (33.), 87.6 (35.)  
 Trefferkreis: 11.96 mm  
 Trefferlage: 0.12 mm links, 0.46 mm tief



Ergebnis: **409.6** (392)  
 Serien: 103.5 102.6 101.8 101.7  
 Zähler: 32 8 0 0 0 0 0 0 0 0  
 Innenzehner: 21  
 Weitester: 352 (38.), 346 (34.), 317 (10.)  
 beste Teiler: 33.2 (22.), 43.5 (18.), 45.8 (1.)  
 Trefferkreis: 11.33 mm  
 Trefferlage: 0.20 mm rechts, 0.08 mm hoch

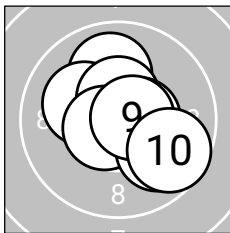
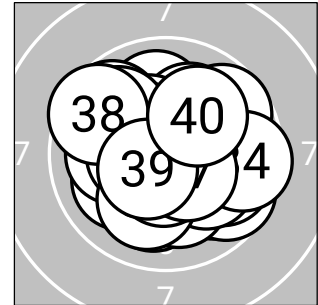

**Serie 1: 103.5** (98)

10.8\*➔ 10.7\*➤ 10.0↑ 10.1↖ 10.5\*↑  
 10.6\*↙ 9.9➤ 10.5\*➔ 10.7\*➔ 9.7➤

beste Teiler: 45.8 (1.), 60.0 (2.), 75.8 (9.)  
 Trefferkreis: 9.77 mm  
 Trefferlage: 0.46 mm rechts, 0.06 mm hoch

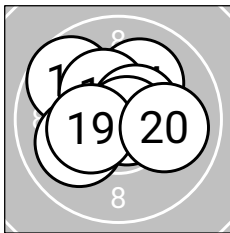

**Serie 2: 102.6** (99)

9.7↖ 10.4\*➤ 10.4\*➔ 10.1↗ 10.3\*↖  
 10.0↙ 10.5\*➤ 10.8\*➔ 10.4\*↖ 10.0➔

beste Teiler: 43.5 (18.), 101.3 (17.), 130.4 (12.)  
 Trefferkreis: 9.82 mm  
 Trefferlage: 0.06 mm rechts, 0.47 mm hoch

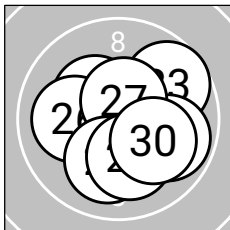

**Serie 3: 101.8** (98)

10.2\*➤ 10.8\*↖ 9.7↗ 10.3\*↖ 9.9➤  
 10.0↖ 10.6\*↗ 10.1↘ 10.1↘ 10.1➤

beste Teiler: 33.2 (22.), 99.0 (27.), 160.8 (24.)  
 Trefferkreis: 9.76 mm  
 Trefferlage: 0.50 mm rechts, 0.14 mm tief

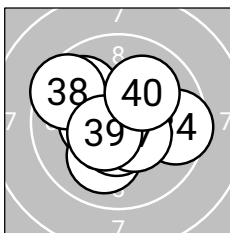

**Serie 4: 101.7** (97)

10.6\*↘ 9.9↖ 10.4\*↖ 9.6➔ 10.1↘  
 10.5\*↘ 10.5\*➤ 9.5↖ 10.5\*↖ 10.1↗

beste Teiler: 86.0 (31.), 101.4 (36.), 106.5 (39.)  
 Trefferkreis: 11.32 mm  
 Trefferlage: 0.21 mm links, 0.04 mm tief



**LG 40 ZR**

StandNr: 109

Oberhofer, Johann\_sen. #70819115

**Senioren\_2m**

Wertung

**StartNr: 242**

01.03.2026 17:00

SG\_Bruckhäusl

SG Bruckhäusl 2

Ergebnis: **415.9** (394)  
 Serien: 103.9 103.3 105.1 103.6  
 Zähler: 34 6 0 0 0 0 0 0 0 0 0  
 Innenzehner: 34  
 Weitester: 309 (14.), 309 (33.), 301 (2.)  
 beste Teiler: 2.2 (16.), 21.1 (37.), 40.3 (26.)  
 Trefferkreis: 10.44 mm  
 Trefferlage: 0.12 mm links, 0.11 mm tief

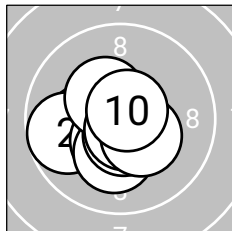
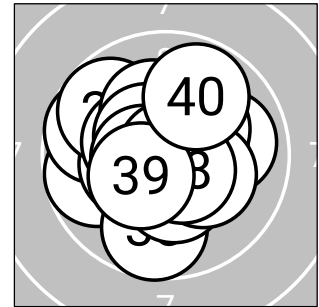
**Serie 1: 103.9** (99)

10.2*←	9.7←	10.6*↘	10.4*↘	10.2*↓
10.6*↓	10.4*↖	10.7*↘	10.4*↗	10.7*↗

beste Teiler: 59.0 (10.), 64.4 (8.), 87.7 (3.)  
 Trefferkreis: 8.56 mm  
 Trefferlage: 0.40 mm links, 0.56 mm tief

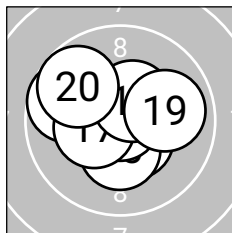
**Serie 2: 103.3** (97)

10.7*↑	10.5*↘	10.7*↖	9.7←	10.3*↓
10.9*↖	10.4*←	10.4*↗	9.9→	9.8↖

beste Teiler: 2.2 (16.), 53.0 (13.), 58.0 (11.)  
 Trefferkreis: 9.89 mm  
 Trefferlage: 0.34 mm links, 0.25 mm hoch

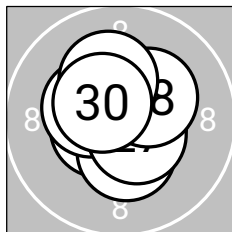
**Serie 3: 105.1** (100)

10.6*→	10.7*↖	10.6*←	10.4*↓	10.4*↖
10.8*→	10.6*↘	10.3*↗	10.2*↑	10.5*↖

beste Teiler: 40.3 (26.), 62.4 (22.), 78.7 (21.)  
 Trefferkreis: 7.83 mm  
 Trefferlage: 0.05 mm links, 0.21 mm hoch

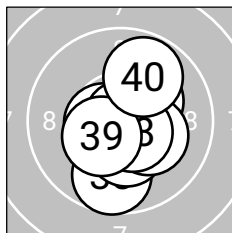
**Serie 4: 103.6** (98)

10.3*↗	10.8*↓	9.7↓	10.6*←	10.3*↓
10.2*↘	10.9*↗	10.6*↘	10.4*↖	9.8↗

beste Teiler: 21.1 (37.), 47.0 (32.), 94.8 (34.)  
 Trefferkreis: 10.32 mm  
 Trefferlage: 0.30 mm rechts, 0.38 mm tief

# LG 40 ZR

StandNr: 110

Koller, Horst #70819302

# Senioren\_2m

Wertung

StartNr: 243

01.03.2026 16:58

SG\_Bad-Häring

SG Bad-Häring 1

Ergebnis: **408.0** (389)  
 Serien: 100.6 101.9 103.3 102.2  
 Zähler: 30 9 1 0 0 0 0 0 0 0 0  
 Innenzehner: 26  
 Weitester: 654 (8.), 459 (18.), 340 (35.)  
 beste Teiler: 22.2 (20.), 39.0 (14.), 43.6 (9.)  
 Trefferkreis: 13.94 mm  
 Trefferlage: 0.35 mm rechts, 0.45 mm tief

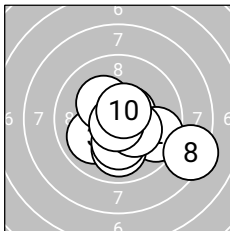
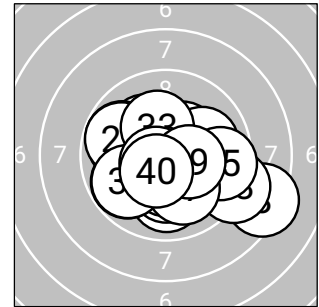

### Serie 1: 100.6 (97)

10.6*➔	9.6➔	10.0↙	10.0↓	10.2*↓
10.2*↙	10.3*➔	8.3➔	10.8*↙	10.6*➔

beste Teiler: 43.6 (9.), 79.3 (10.), 92.1 (1.)  
 Trefferkreis: 12.77 mm  
 Trefferlage: 0.83 mm rechts, 0.87 mm tief

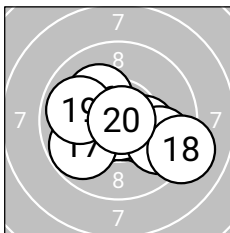

### Serie 2: 101.9 (96)

10.7*➔	10.5*↙	10.3*➔	10.8*↓	9.7➔
10.2*↙	9.8↙	9.1➔	9.9↙	10.9*➔

beste Teiler: 22.2 (20.), 39.0 (14.), 64.8 (11.)  
 Trefferkreis: 11.72 mm  
 Trefferlage: 0.20 mm rechts, 0.45 mm tief

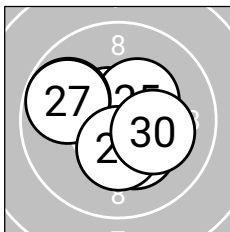

### Serie 3: 103.3 (98)

10.5*➔	10.7*↗	10.7*↙	10.6*↙	10.4*↗
9.8↙	9.8↙	10.3*➔	10.3*↓	10.2*➔

beste Teiler: 54.2 (23.), 59.4 (22.), 79.2 (24.)  
 Trefferkreis: 9.36 mm  
 Trefferlage: 0.13 mm links, 0.02 mm hoch

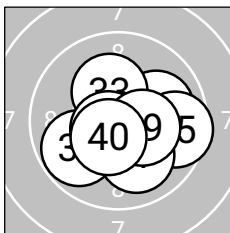

### Serie 4: 102.2 (98)

10.7*➔	10.0➔	10.2*↗	10.4*↙	9.6➔
9.8↙	10.0↓	10.6*↙	10.4*➔	10.5*↙

beste Teiler: 60.2 (31.), 78.1 (38.), 113.0 (40.)  
 Trefferkreis: 10.29 mm  
 Trefferlage: 0.52 mm rechts, 0.49 mm tief

