

Ergebnis: **414.3** (394)
 Serien: 101.6 105.2 102.3 105.2
 Zähler: 34 6 0 0 0 0 0 0 0 0
 Innenzehner: 32
 Weitest: 419 (9.), 401 (2.), 283 (22.)
 beste Teiler: 44.5 (18.), 48.1 (26.), 50.6 (35.)
 Trefferkreis: 11.52 mm
 Trefferlage: 0.03 mm links, 0.43 mm tief

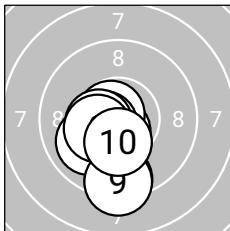
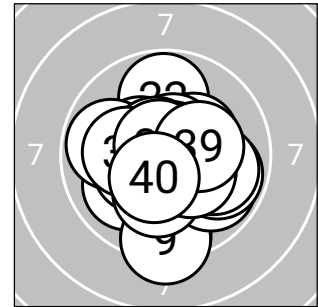

Serie 1: 101.6 (98)

10.6*↓	9.3↓	10.7*↖	10.2*↓	10.0↙
10.5*↖	10.4*↖	10.3*↖	9.3↓	10.3*↓

beste Teiler: 57.8 (3.), 82.7 (1.), 104.5 (6.)
 Trefferkreis: 9.01 mm
 Trefferlage: 0.66 mm links, 1.49 mm tief

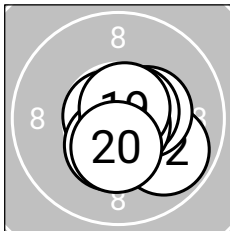

Serie 2: 105.2 (99)

10.6*↘	9.9↘	10.7*↙	10.4*→	10.7*↖
10.4*↓	10.6*→	10.8*↘	10.7*↗	10.4*↓

beste Teiler: 44.5 (18.), 51.0 (13.), 51.4 (15.)
 Trefferkreis: 7.71 mm
 Trefferlage: 0.44 mm rechts, 0.42 mm tief

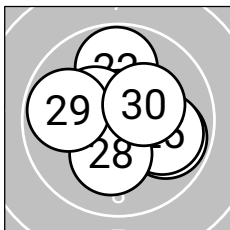

Serie 3: 102.3 (97)

10.7*↘	9.8↑	10.4*↖	9.9↘	10.0→
10.8*↑	10.4*↖	10.2*↓	9.8↖	10.3*↗

beste Teiler: 48.1 (26.), 70.6 (21.), 132.6 (23.)
 Trefferkreis: 10.05 mm
 Trefferlage: 0.12 mm rechts, 0.19 mm hoch

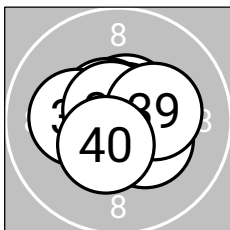

Serie 4: 105.2 (100)

10.6*↙	10.6*↗	10.3*↘	10.7*↗	10.8*↖
10.6*↖	10.2*↖	10.7*↖	10.3*→	10.4*↓

beste Teiler: 50.6 (35.), 51.8 (34.), 61.2 (38.)
 Trefferkreis: 8.08 mm
 Trefferlage: 0.06 mm links, 0.00 mm



Ergebnis: **403.9** (386)
 Serien: 98.4 101.5 100.9 103.1
 Zähler: 26 14 0 0 0 0 0 0 0 0
 Innenzehner: 20
 Weitester: 495 (24.), 454 (12.), 390 (9.)
 beste Teiler: 14.1 (40.), 43.8 (13.), 52.8 (17.)
 Trefferkreis: 13.22 mm
 Trefferlage: 0.05 mm rechts, 0.57 mm tief

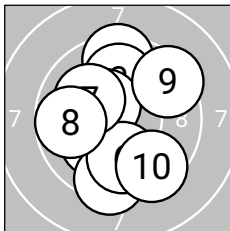
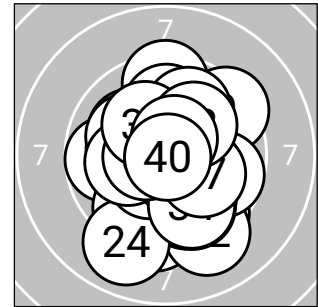

Serie 1: 98.4 (95)
 9.5↑ 10.2*↙ 10.0↑ 10.5*↖ 9.4↓
 10.0↓ 10.1↖ 9.8← 9.4↗ 9.5↘
 beste Teiler: 121.6 (4.), 200.1 (2.), 218.5 (7.)
 Trefferkreis: 12.09 mm
 Trefferlage: 0.21 mm links, 0.01 mm tief

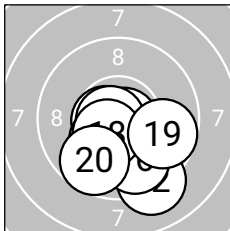

Serie 2: 101.5 (96)
 10.6*← 9.1↘ 10.8*↘ 10.3*↙ 10.3*↘
 9.8↘ 10.7*← 10.5*↙ 9.7↘ 9.7↙
 beste Teiler: 43.8 (13.), 52.8 (17.), 82.2 (11.)
 Trefferkreis: 9.37 mm
 Trefferlage: 0.25 mm rechts, 1.49 mm tief

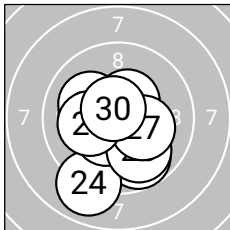

Serie 3: 100.9 (97)
 9.8↘ 10.4*↗ 10.2*← 9.0↙ 10.4*↙
 9.9↘ 10.2*↘ 10.1↖ 10.2*← 10.7*↖
 beste Teiler: 74.7 (30.), 129.3 (22.), 135.2 (25.)
 Trefferkreis: 10.75 mm
 Trefferlage: 0.39 mm links, 0.84 mm tief

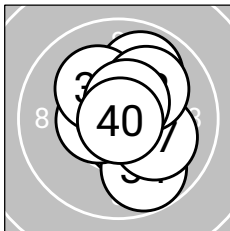

Serie 4: 103.1 (98)
 9.9↗ 10.4*↘ 10.6*↘ 9.8↘ 10.5*←
 10.2*↖ 10.1↘ 10.1↗ 10.6*↗ 10.9*↘
 beste Teiler: 14.1 (40.), 96.6 (39.), 98.7 (33.)
 Trefferkreis: 9.54 mm
 Trefferlage: 0.56 mm rechts, 0.07 mm hoch

Ergebnis: 413.7 (391)
Serien: 100.7 103.5 103.9 105.6
Zähler: 31 9 0 0 0 0 0 0 0 0
Innenzehner: 30
Weiteste: 389 (3.), 355 (18.), 340 (6.)
beste Teiler: 4.1 (24.), 11.0 (32.), 21.4 (40.)
Trefferkreis: 11.66 mm
Trefferlage: 0.32 mm links, 0.04 mm hoch

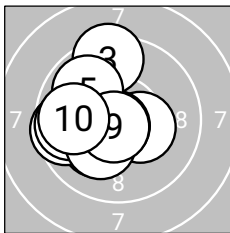
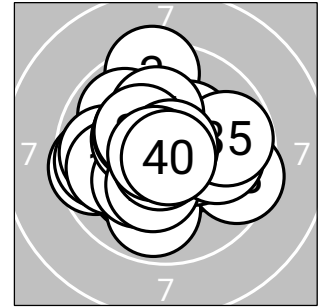

Serie 1: 100.7 (95)

10.4*➔	10.2*↙	9.4↑	10.8*↙	9.9↘
9.6↙	9.7↙	10.2*↙	10.7*↙	9.8↙

beste Teiler: 45.4 (4.), 54.3 (9.), 147.0 (1.)
Trefferkreis: 10.19 mm
Trefferlage: 1.34 mm links, 0.05 mm hoch

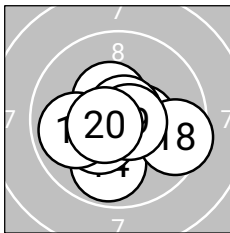

Serie 2: 103.5 (97)

10.4*↖	10.8*↗	10.5*➔	9.9↓	10.8*↗
10.4*↙	9.9↙	9.5➔	10.7*➔	10.6*↙

beste Teiler: 34.4 (12.), 49.5 (15.), 66.9 (19.)
Trefferkreis: 10.40 mm
Trefferlage: 0.03 mm rechts, 0.42 mm tief

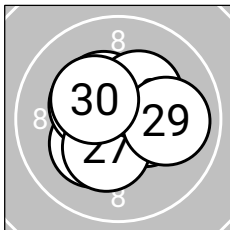

Serie 3: 103.9 (100)

10.4*↖	10.2*↙	10.4*↖	10.9*↓	10.7*↙
10.4*➔	10.3*↙	10.3*↗	10.0➔	10.3*↖

beste Teiler: 4.1 (24.), 68.8 (25.), 135.3 (26.)
Trefferkreis: 8.53 mm
Trefferlage: 0.06 mm links, 0.05 mm hoch

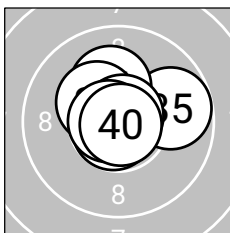

Serie 4: 105.6 (99)

10.8*↙	10.9*↑	10.6*↖	10.6*↗	9.8➔
10.2*↑	10.3*↖	10.8*↗	10.7*↙	10.9*↘

beste Teiler: 11.0 (32.), 21.4 (40.), 40.2 (38.)
Trefferkreis: 8.55 mm
Trefferlage: 0.08 mm rechts, 0.50 mm hoch

Ergebnis: **423.0** (400)
 Serien: 105.0 105.7 106.2 106.1
 Zähler: 40 0 0 0 0 0 0 0 0 0 0
 Innenzehner: 40
 Weitester: 186 (4.), 175 (38.), 172 (3.)
 beste Teiler: 23.7 (33.), 32.0 (22.), 35.4 (23.)
 Trefferkreis: 8.06 mm
 Trefferlage: 0.09 mm rechts, 0.08 mm hoch

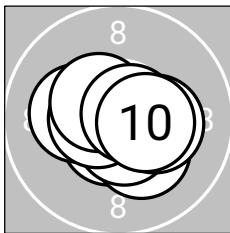
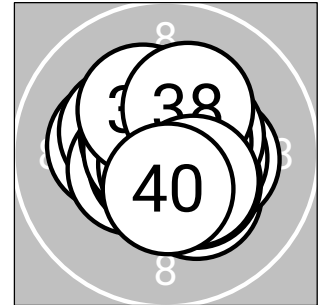

Serie 1: 105.0 (100)

10.6*↙	10.7*→	10.3*↘	10.2*←	10.6*↘
10.6*←	10.3*→	10.5*↖	10.7*→	10.5*→

beste Teiler: 60.8 (9.), 69.6 (2.), 80.0 (5.)
 Trefferkreis: 8.05 mm
 Trefferlage: 0.13 mm rechts, 0.19 mm tief

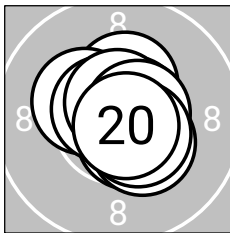

Serie 2: 105.7 (100)

10.6*↘	10.4*↑	10.3*↖	10.7*↖	10.7*↗
10.7*↑	10.4*↘	10.6*→	10.5*↘	10.8*↘

beste Teiler: 42.6 (20.), 68.8 (15.), 72.1 (16.)
 Trefferkreis: 7.53 mm
 Trefferlage: 0.22 mm rechts, 0.14 mm hoch

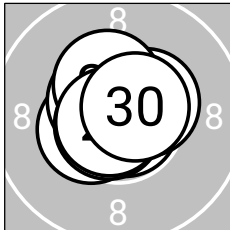

Serie 3: 106.2 (100)

10.5*↖	10.8*←	10.8*↘	10.6*↗	10.6*↖
10.7*↖	10.4*→	10.4*↖	10.8*←	10.6*↗

beste Teiler: 32.0 (22.), 35.4 (23.), 41.1 (29.)
 Trefferkreis: 7.03 mm
 Trefferlage: 0.07 mm links, 0.22 mm hoch

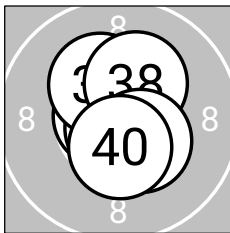

Serie 4: 106.1 (100)

10.7*↑	10.8*↑	10.9*→	10.7*←	10.8*↓
10.7*↘	10.3*↖	10.3*↗	10.4*↘	10.5*↓

beste Teiler: 23.7 (33.), 36.8 (35.), 44.7 (32.)
 Trefferkreis: 7.51 mm
 Trefferlage: 0.10 mm rechts, 0.14 mm hoch

LG 40 ZR

StandNr: 109

Zobl, Gerhard #70819243

Senioren_3am

Wertung

StartNr: 148

01.03.2026 14:08

SG_Schattwald-Zöblen

Ergebnis: **420.1 (398)**
 Serien: 105.4 104.9 105.9 103.9
 Zähler: 38 2 0 0 0 0 0 0 0 0
 Innenzehner: 35
 Weitestе: 302 (31.), 279 (3.), 237 (38.)
 beste Teiler: 37.1 (17.), 39.8 (30.), 44.0 (13.)
 Trefferkreis: 10.32 mm
 Trefferlage: 0.09 mm links, 0.16 mm hoch

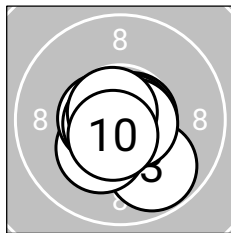
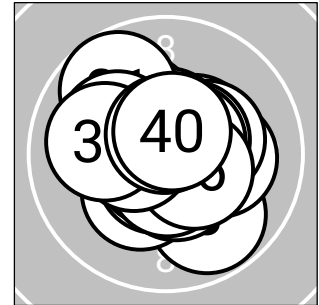
**Serie 1: 105.4 (99)**

10.5*↙ 10.7*→ 9.8↘ 10.8*→ 10.7*→
 10.3*↙ 10.6*← 10.7*← 10.7*↖ 10.6*↙

beste Teiler: 48.0 (4.), 54.4 (9.), 60.0 (2.)
 Trefferkreis: 7.93 mm
 Trefferlage: 0.07 mm links, 0.51 mm tief

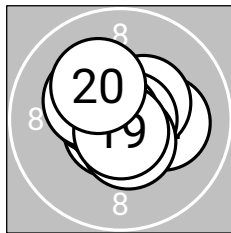
**Serie 2: 104.9 (100)**

10.1→ 10.4*↗ 10.8*→ 10.7*↙ 10.5*↘
 10.4*↖ 10.8*← 10.3*↖ 10.7*↓ 10.2*↖

beste Teiler: 37.1 (17.), 44.0 (13.), 57.1 (19.)
 Trefferkreis: 8.08 mm
 Trefferlage: 0.04 mm links, 0.16 mm hoch

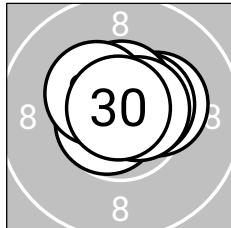
**Serie 3: 105.9 (100)**

10.3*↗ 10.5*↗ 10.7*↖ 10.7*↖ 10.7*↗
 10.7*↗ 10.5*↑ 10.6*↗ 10.4*↖ 10.8*↑

beste Teiler: 39.8 (30.), 52.8 (26.), 59.4 (23.)
 Trefferkreis: 7.11 mm
 Trefferlage: 0.17 mm rechts, 0.50 mm hoch

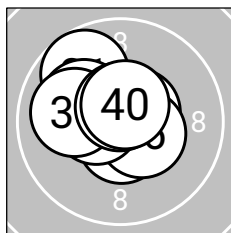
**Serie 4: 103.9 (99)**

9.7↖ 10.7*↗ 10.6*↗ 10.6*↓ 10.1↖
 10.5*↘ 10.5*← 10.0← 10.6*↑ 10.6*↑

beste Teiler: 67.6 (32.), 76.1 (39.), 89.2 (40.)
 Trefferkreis: 8.69 mm
 Trefferlage: 0.45 mm links, 0.48 mm hoch

Ergebnis: 406.7 (390)
Serien: 101.7 102.6 99.2 103.2
Zähler: 31 8 1 0 0 0 0 0 0 0
Innenzehner: 23
Weiteste: 522 (28.), 472 (1.), 395 (21.)
beste Teiler: 30.6 (18.), 36.2 (33.), 55.2 (35.)
Trefferkreis: 13.37 mm
Trefferlage: 0.11 mm rechts, 0.12 mm hoch

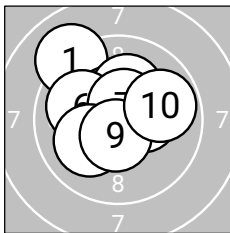
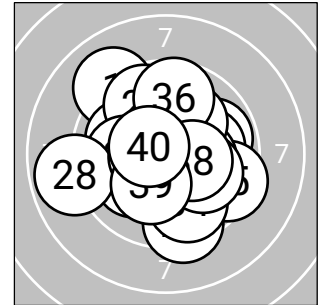

Serie 1: 101.7 (98)

9.1 ↖	10.5* ↖	10.2* ↗	10.4* ↖	10.3* →
10.0 ↖	10.6* ↗	10.1 ↖	10.6* ↓	9.9 →

beste Teiler: 98.0 (7.), 99.2 (9.), 121.6 (2.)
Trefferkreis: 10.90 mm
Trefferlage: 0.39 mm links, 0.74 mm hoch

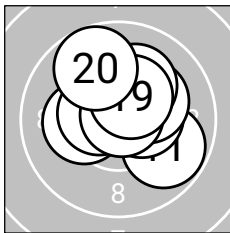

Serie 2: 102.6 (98)

9.8 ↘	10.4* ↗	10.2* ↖	10.4* →	10.2* ↗
10.1 ↗	10.5* ↖	10.8* ↗	10.4* ↗	9.8 ↖

beste Teiler: 30.6 (18.), 108.1 (17.), 128.4 (14.)
Trefferkreis: 10.05 mm
Trefferlage: 0.36 mm rechts, 0.71 mm hoch

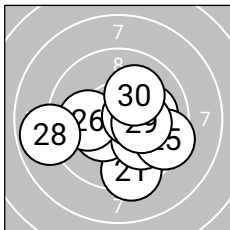

Serie 3: 99.2 (96)

9.4 ↓	10.4* ↖	10.0 ↘	10.1 →	9.4 ↘
10.1 ↖	10.5* →	8.9 ↖	10.3* →	10.1 ↗

beste Teiler: 105.3 (27.), 142.9 (22.), 175.4 (29.)
Trefferkreis: 13.05 mm
Trefferlage: 0.38 mm rechts, 0.69 mm tief

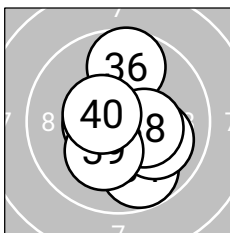

Serie 4: 103.2 (98)

10.6* ↖	10.6* ↖	10.8* ↖	9.8 ↓	10.7* ↖
9.7 ↗	10.0 ↘	10.3* →	10.2* ↖	10.5* ↖

beste Teiler: 36.2 (33.), 55.2 (35.), 79.3 (31.)
Trefferkreis: 10.36 mm
Trefferlage: 0.09 mm rechts, 0.26 mm tief



Ergebnis: 423.2 (399)
Serien: 104.9 106.2 106.6 105.5
Zähler: 39 1 0 0 0 0 0 0 0 0
Innenzehner: 38
Weiteste: 261 (14.), 242 (31.), 166 (39.)
beste Teiler: 10.0 (40.), 15.6 (13.), 15.6 (20.)
Trefferkreis: 9.50 mm
Trefferlage: 0.18 mm links, 0.00 mm

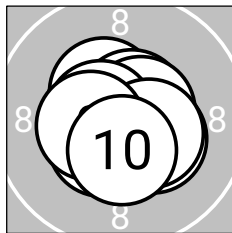
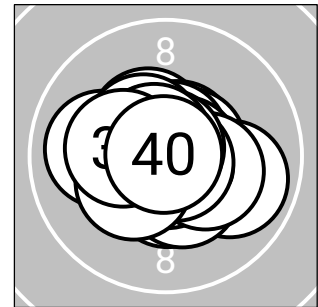

Serie 1: 104.9 (100)

10.6*↖	10.4*↖	10.6*↗	10.5*↙	10.3*↘
10.6*↗	10.6*↖	10.4*↘	10.5*↖	10.4*↓

beste Teiler: 79.4 (3.), 83.1 (7.), 91.3 (6.)
Trefferkreis: 7.30 mm
Trefferlage: 0.03 mm links, 0.09 mm tief

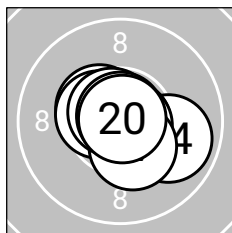

Serie 2: 106.2 (99)

10.5*↖	10.5*↖	10.9*↗	9.9↘	10.8*↘
10.8*↘	10.4*↘	10.7*↖	10.8*↑	10.9*↗

beste Teiler: 15.6 (13.), 15.6 (20.), 28.0 (19.)
Trefferkreis: 8.35 mm
Trefferlage: 0.14 mm rechts, 0.04 mm tief

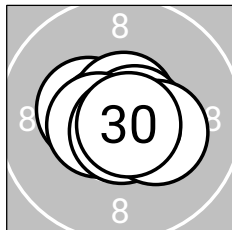

Serie 3: 106.6 (100)

10.9*↓	10.4*↖	10.8*↗	10.7*↖	10.7*↑
10.7*↗	10.6*↖	10.7*↓	10.3*↘	10.8*↘

beste Teiler: 16.1 (21.), 43.8 (30.), 45.0 (23.)
Trefferkreis: 7.56 mm
Trefferlage: 0.03 mm rechts, 0.06 mm tief

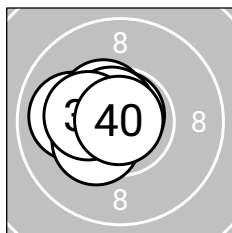

Serie 4: 105.5 (100)

10.0↖	10.5*↖	10.6*↖	10.8*↑	10.7*↖
10.7*↖	10.3*↙	10.7*↖	10.3*↖	10.9*↖

beste Teiler: 10.0 (40.), 33.0 (34.), 68.8 (36.)
Trefferkreis: 6.91 mm
Trefferlage: 0.87 mm links, 0.20 mm hoch



LG 40 ZR

StandNr: 112

Wierer, Alfred #70819166

Senioren_3am

Wertung

StartNr: 151

01.03.2026 14:14

SG_Aschau

SG Aschau 1

Ergebnis: **419.3** (397)
 Serien: 103.8 104.9 105.4 105.2
 Zähler: 37 3 0 0 0 0 0 0 0 0 0
 Innenzehner: 37
 Weitester: 330 (9.), 260 (24.), 254 (38.)
 beste Teiler: 21.3 (34.), 26.6 (4.), 45.0 (27.)
 Trefferkreis: 9.81 mm
 Trefferlage: 0.02 mm rechts, 0.20 mm hoch

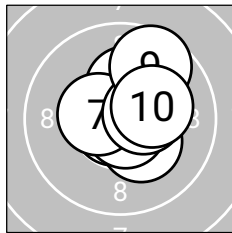
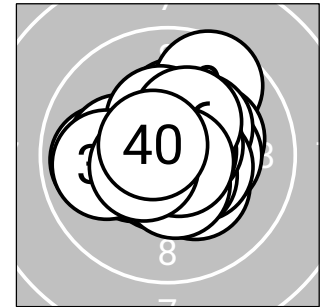
**Serie 1: 103.8** (99)

10.8*↙	10.3*↘	10.3*↗	10.8*→	10.7*↘
10.2*↑	10.5*←	10.4*→	9.6↗	10.2*→

beste Teiler: 26.6 (4.), 46.0 (1.), 54.3 (5.)
 Trefferkreis: 8.77 mm
 Trefferlage: 0.61 mm rechts, 0.51 mm hoch

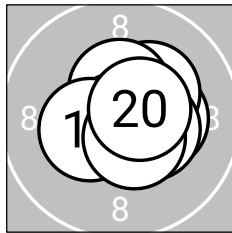
**Serie 2: 104.9** (100)

10.3*→	10.5*↗	10.7*↙	10.7*↑	10.3*↗
10.5*↑	10.4*←	10.4*→	10.5*↘	10.6*→

beste Teiler: 63.6 (13.), 74.6 (14.), 94.3 (20.)
 Trefferkreis: 7.58 mm
 Trefferlage: 0.48 mm rechts, 0.18 mm hoch

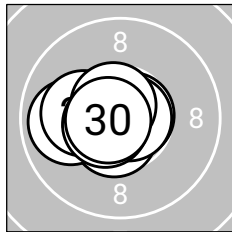
**Serie 3: 105.4** (99)

10.6*↙	10.7*→	10.6*↙	9.9←	10.7*↖
10.2*←	10.8*→	10.6*←	10.6*↖	10.7*←

beste Teiler: 45.0 (27.), 54.4 (25.), 59.9 (22.)
 Trefferkreis: 7.70 mm
 Trefferlage: 0.63 mm links, 0.07 mm tief

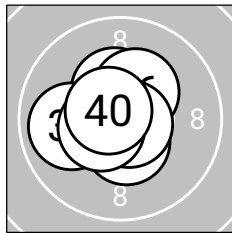
**Serie 4: 105.2** (99)

10.7*↖	10.5*↘	10.6*↖	10.9*↓	10.4*↑
10.3*↗	10.7*↘	9.9←	10.5*←	10.7*↖

beste Teiler: 21.3 (34.), 51.6 (31.), 53.3 (37.)
 Trefferkreis: 8.26 mm
 Trefferlage: 0.36 mm links, 0.18 mm hoch

Ergebnis: 401.8 (382)
Serien: 99.9 100.6 101.7 99.6
Zähler: 24 14 2 0 0 0 0 0 0 0
Innenzehner: 21
Weiteste: 533 (8.), 512 (35.), 494 (36.)
beste Teiler: 23.3 (17.), 42.4 (26.), 72.7 (23.)
Trefferkreis: 14.48 mm
Trefferlage: 0.03 mm rechts, 0.12 mm hoch

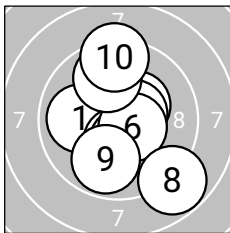
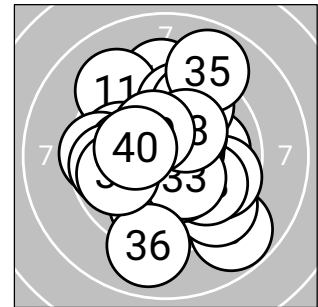

Serie 1: 99.9 (95)
 10.0 ← 10.3* ↗ 10.5* → 10.4* ↓ 10.4* ↓
 10.5* ↘ 9.8 ↑ 8.8 ↘ 9.9 ↓ 9.3 ↑
beste Teiler: 105.1 (3.), 106.0 (6.), 142.0 (4.)
Trefferkreis: 13.43 mm
Trefferlage: 0.26 mm rechts, 0.16 mm tief

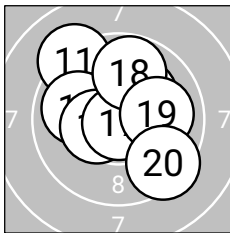

Serie 2: 100.6 (96)
 9.2 ↘ 10.4* ↗ 10.4* ← 9.9 ← 10.4* ←
 10.2* ↗ 10.9* ↓ 9.8 ↑ 10.0 → 9.4 ↘
beste Teiler: 23.3 (17.), 128.7 (12.), 129.7 (13.)
Trefferkreis: 12.73 mm
Trefferlage: 0.05 mm rechts, 0.70 mm hoch

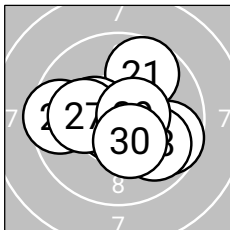

Serie 3: 101.7 (96)
 9.7 ↗ 9.7 ↘ 10.7* ↘ 9.5 ← 10.4* ←
 10.8* ↘ 10.1 ← 9.9 ↘ 10.6* → 10.3* ↘
beste Teiler: 42.4 (26.), 72.7 (23.), 94.6 (29.)
Trefferkreis: 11.18 mm
Trefferlage: 0.15 mm rechts, 0.10 mm tief

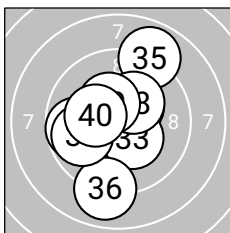

Serie 4: 99.6 (95)
 10.3* ↗ 10.6* ↓ 10.3* ↘ 9.7 ← 8.9 ↗
 9.0 ↓ 9.8 ← 10.3* ↗ 10.4* ↘ 10.3* ←
beste Teiler: 78.8 (32.), 146.7 (39.), 152.7 (31.)
Trefferkreis: 14.48 mm
Trefferlage: 0.33 mm links, 0.05 mm hoch



Ergebnis: **416.5** (399)
 Serien: 104.5 104.0 104.1 103.9
 Zähler: 39 1 0 0 0 0 0 0 0 0
 Innenzehner: 36
 Weitestе: 410 (19.), 239 (11.), 229 (40.)
 beste Teiler: 21.9 (12.), 51.0 (26.), 59.2 (35.)
 Trefferkreis: 10.26 mm
 Trefferlage: 0.02 mm links, 0.26 mm hoch

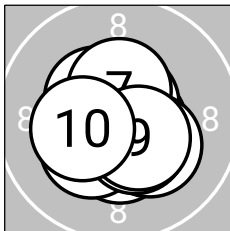
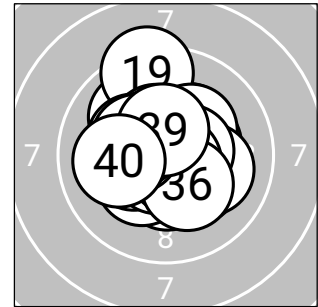

Serie 1: 104.5 (100)

10.7*→	10.4*↓	10.3*↙	10.7*↗	10.4*↖
10.2*↘	10.5*↑	10.5*↘	10.5*↘	10.3*↖

beste Teiler: 75.2 (4.), 75.8 (1.), 120.2 (9.)
 Trefferkreis: 7.64 mm
 Trefferlage: 0.05 mm rechts, 0.34 mm tief

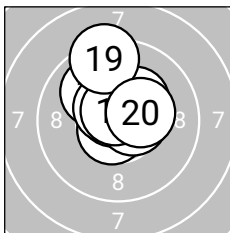

Serie 2: 104.0 (99)

10.0↖	10.9*↙	10.3*↗	10.7*↙	10.7*↖
10.6*→	10.5*↖	10.7*↖	9.3↑	10.3*→

beste Teiler: 21.9 (12.), 64.1 (15.), 67.0 (18.)
 Trefferkreis: 9.13 mm
 Trefferlage: 0.07 mm links, 0.88 mm hoch

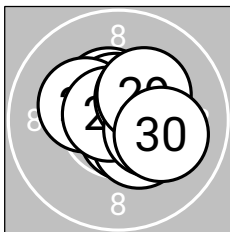

Serie 3: 104.1 (100)

10.4*↖	10.6*↑	10.3*↖	10.7*↘	10.4*↘
10.7*↖	10.3*↗	10.3*→	10.3*↗	10.1→

beste Teiler: 51.0 (26.), 71.3 (24.), 94.7 (22.)
 Trefferkreis: 8.39 mm
 Trefferlage: 0.47 mm rechts, 0.26 mm hoch

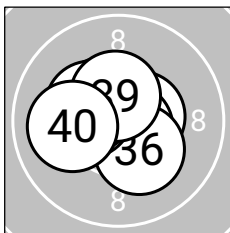

Serie 4: 103.9 (100)

10.6*↖	10.5*→	10.3*↖	10.5*↖	10.7*↘
10.2*↘	10.3*↖	10.3*↖	10.5*↑	10.0↖

beste Teiler: 59.2 (35.), 93.8 (31.), 109.0 (32.)
 Trefferkreis: 8.07 mm
 Trefferlage: 0.56 mm links, 0.23 mm hoch



Ergebnis: 422.7 (400)
Serien: 105.0 104.7 106.3 106.7
Zähler: 40 0 0 0 0 0 0 0 0 0 0
Innenzehner: 39
Weiteste: 226 (18.), 190 (2.), 186 (8.)
beste Teiler: 14.4 (32.), 16.1 (34.), 20.2 (31.)
Trefferkreis: 8.42 mm
Trefferlage: 0.09 mm links, 0.21 mm hoch

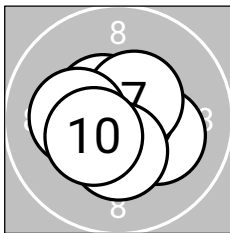
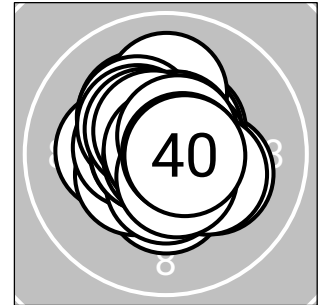

Serie 1: 105.0 (100)

10.7*←	10.2*→	10.6*↓	10.5*↖	10.7*←
10.8*↗	10.5*↗	10.2*←	10.4*↓	10.4*↖

beste Teiler: 44.5 (6.), 59.5 (1.), 68.1 (5.)
Trefferkreis: 8.22 mm
Trefferlage: 0.24 mm links, 0.20 mm tief

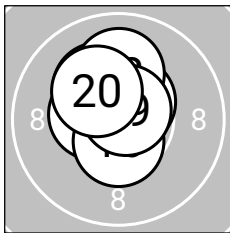

Serie 2: 104.7 (100)

10.6*←	10.6*←	10.2*↖	10.8*↑	10.5*←
10.5*↓	10.5*↗	10.0↑	10.7*↗	10.3*↖

beste Teiler: 42.9 (14.), 59.0 (19.), 82.0 (11.)
Trefferkreis: 7.84 mm
Trefferlage: 0.40 mm links, 0.62 mm hoch

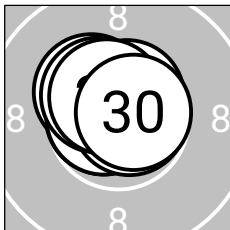

Serie 3: 106.3 (100)

10.7*←	10.4*↖	10.7*↑	10.6*↖	10.7*←
10.6*↗	10.5*↖	10.8*→	10.6*↖	10.7*↗

beste Teiler: 43.4 (28.), 56.5 (25.), 58.5 (23.)
Trefferkreis: 6.32 mm
Trefferlage: 0.26 mm links, 0.53 mm hoch

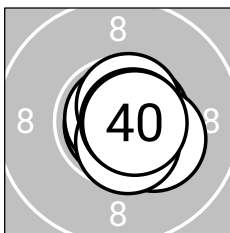

Serie 4: 106.7 (100)

10.9*↗	10.9*↖	10.6*→	10.9*↖	10.5*→
10.6*↗	10.3*→	10.6*↓	10.7*→	10.7*→

beste Teiler: 14.4 (32.), 16.1 (34.), 20.2 (31.)
Trefferkreis: 6.34 mm
Trefferlage: 0.54 mm rechts, 0.09 mm tief



LG 40 ZR

StandNr: 116

Isep, Margaritha #70819274

Senioren_3aw

Wertung

StartNr: 155

01.03.2026 14:07

SG_Lienz_SSV

SG Lienz SSV 1

Ergebnis: **414.1** (393)
 Serien: 104.6 102.4 104.0 103.1
 Zähler: 33 7 0 0 0 0 0 0 0 0
 Innenzehner: 32
 Weitester: 324 (19.), 292 (12.), 288 (14.)
 beste Teiler: 13.0 (4.), 23.1 (13.), 28.1 (17.)
 Trefferkreis: 10.53 mm
 Trefferlage: 0.24 mm links, 0.08 mm tief

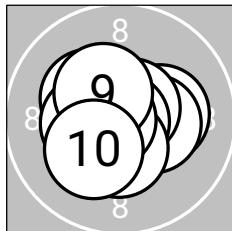
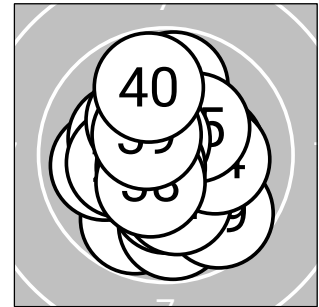
**Serie 1: 104.6** (100)

10.2*→	10.4*→	10.7*↗	10.9*↓	10.4*↓
10.3*↖	10.7*←	10.4*←	10.4*↖	10.2*↖

beste Teiler: 13.0 (4.), 62.2 (7.), 69.3 (3.)
 Trefferkreis: 8.09 mm
 Trefferlage: 0.17 mm links, 0.04 mm tief

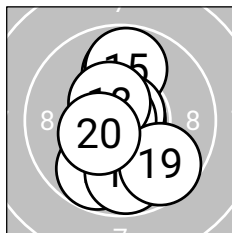
**Serie 2: 102.4** (95)

9.9↑	9.8↙	10.9*→	9.8↓	9.8↑
10.8*↗	10.8*←	10.5*↖	9.7↘	10.4*↖

beste Teiler: 23.1 (13.), 28.1 (17.), 38.9 (16.)
 Trefferkreis: 10.41 mm
 Trefferlage: 0.00 mm, 0.18 mm tief

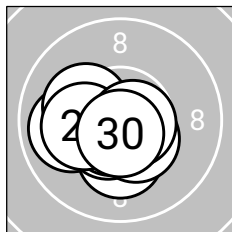
**Serie 3: 104.0** (99)

10.6*←	9.9←	10.2*←	10.2*↓	10.5*↙
10.4*↘	10.6*↙	10.2*←	10.7*→	10.7*↓

beste Teiler: 66.7 (29.), 69.0 (30.), 77.2 (27.)
 Trefferkreis: 7.86 mm
 Trefferlage: 0.67 mm links, 0.53 mm tief

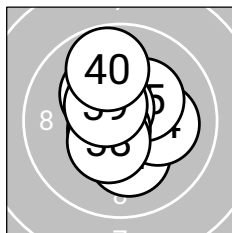
**Serie 4: 103.1** (99)

10.2*↓	10.4*↖	10.2*↖	10.1→	10.3*↗
10.6*↖	10.6*↙	10.4*↙	10.5*↖	9.8↑

beste Teiler: 78.2 (36.), 79.6 (37.), 115.3 (39.)
 Trefferkreis: 9.29 mm
 Trefferlage: 0.12 mm links, 0.43 mm hoch