

LG 40 ZR

StandNr: 112

Niederhauser, Gerda #70819215

Senioren_1w

Wertung

StartNr: 197

01.03.2026 15:32

SG_Thaur

SG Thaur 1

Ergebnis: **421.5** (400)
 Serien: 104.8 105.6 105.1 106.0
 Zähler: 40 0 0 0 0 0 0 0 0 0 0
 Innenzehner: 37
 Weitest: 228 (39.), 214 (8.), 203 (25.)
 beste Teiler: 13.0 (40.), 22.4 (32.), 26.1 (2.)
 Trefferkreis: 8.76 mm
 Trefferlage: 0.16 mm rechts, 0.09 mm tief

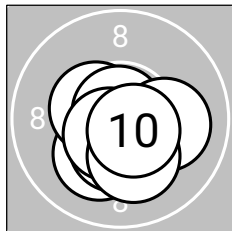
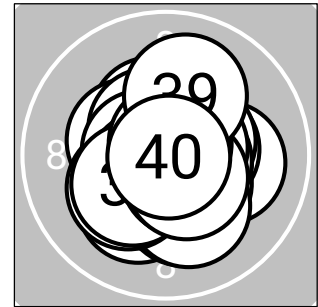
**Serie 1: 104.8** (100)

10.2*↙

10.8*↘

10.4*↖

10.7*↘

10.8*↗

10.4*↘

10.6*↙

10.1→

10.2*↘

10.6*↘

beste Teiler: 26.1 (2.), 32.2 (5.), 52.9 (4.)

Trefferkreis: 8.12 mm

Trefferlage: 0.07 mm rechts, 0.62 mm tief

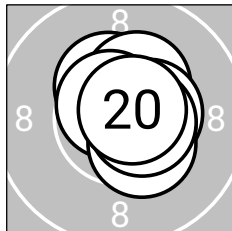
**Serie 2: 105.6** (100)

10.6*↗

10.4*↗

10.3*↗

10.5*→

10.8*↗

10.7*↖

10.6*→

10.4*↘

10.6*→

10.7*↗

beste Teiler: 44.0 (15.), 61.6 (20.), 71.6 (16.)

Trefferkreis: 7.25 mm

Trefferlage: 0.49 mm rechts, 0.34 mm hoch

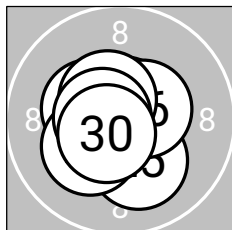
**Serie 3: 105.1** (100)

10.7*↗

10.7*↘

10.4*↖

10.8*↗

10.1↘

10.5*↗

10.5*↖

10.2*↖

10.6*↖

10.6*↖

beste Teiler: 26.9 (24.), 58.8 (22.), 67.9 (21.)

Trefferkreis: 7.77 mm

Trefferlage: 0.21 mm links, 0.08 mm tief

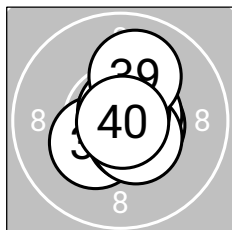
**Serie 4: 106.0** (100)

10.6*→

10.9*↗

10.8*↘

10.3*↖

10.6*↗

10.6*↘

10.5*↘

10.8*↗

10.0↗

10.9*↘

beste Teiler: 13.0 (40.), 22.4 (32.), 43.8 (33.)

Trefferkreis: 8.26 mm

Trefferlage: 0.31 mm rechts, 0.01 mm tief

Ergebnis: **413.6** (396)
 Serien: 104.2 104.0 103.3 102.1
 Zähler: 36 4 0 0 0 0 0 0 0 0
 Innenzehner: 29
 Weitester: 436 (36.), 336 (16.), 272 (15.)
 beste Teiler: 11.1 (23.), 27.8 (12.), 41.0 (3.)
 Trefferkreis: 12.23 mm
 Trefferlage: 0.29 mm links, 0.19 mm hoch

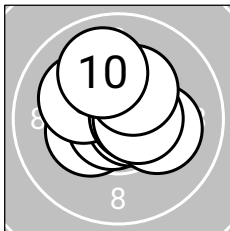
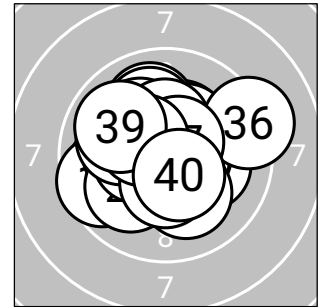

Serie 1: 104.2 (100)

10.6*↗	10.3*↖	10.8*↘	10.7*↘	10.1↖
10.6*↗	10.2*↗	10.6*↗	10.3*↗	10.0↖

beste Teiler: 41.0 (3.), 66.9 (4.), 81.2 (6.)
 Trefferkreis: 8.52 mm
 Trefferlage: 0.16 mm rechts, 0.40 mm hoch

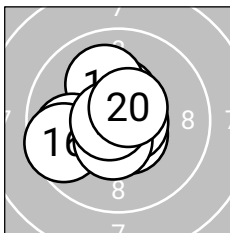

Serie 2: 104.0 (98)

10.6*↘	10.8*↘	10.4*↑	10.1↖	9.9↖
9.6↖	10.7*↗	10.5*↓	10.8*↖	10.6*↗

beste Teiler: 27.8 (12.), 50.0 (19.), 61.0 (17.)
 Trefferkreis: 8.79 mm
 Trefferlage: 0.53 mm links, 0.00 mm

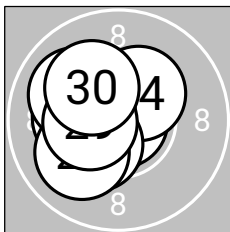

Serie 3: 103.3 (100)

10.4*↖	10.6*↖	10.9*↗	10.3*↗	10.2*↖
10.3*↖	10.0↖	10.0↖	10.4*↖	10.2*↖

beste Teiler: 11.1 (23.), 92.0 (22.), 135.5 (29.)
 Trefferkreis: 8.40 mm
 Trefferlage: 0.97 mm links, 0.18 mm hoch

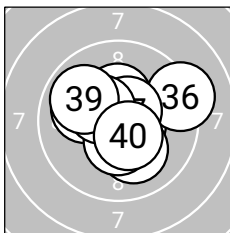

Serie 4: 102.1 (98)

10.0↖	10.6*↗	10.1↘	10.4*↓	10.4*↑
9.2↗	10.6*↗	10.4*↖	9.9↖	10.5*↘

beste Teiler: 88.4 (37.), 92.1 (32.), 117.5 (40.)
 Trefferkreis: 10.81 mm
 Trefferlage: 0.16 mm rechts, 0.21 mm hoch



Ergebnis: **409.7 (393)**
 Serien: 102.7 102.2 102.2 102.6
 Zähler: 33 7 0 0 0 0 0 0 0 0 0
 Innenzehner: 23
 Weitester: 372 (21.), 345 (2.), 301 (38.)
 beste Teiler: 5.0 (40.), 53.0 (25.), 63.0 (34.)
 Trefferkreis: 10.71 mm
 Trefferlage: 0.34 mm links, 0.58 mm tief

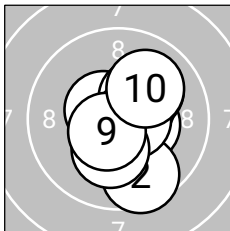
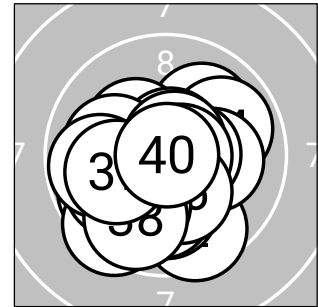

Serie 1: 102.7 (99)

10.4*→	9.6↓	10.1↗	10.5*↖	10.4*↗
10.3*↗	10.6*→	10.2*↓	10.6*↖	10.0↗

beste Teiler: 81.0 (7.), 99.1 (9.), 101.3 (4.)
 Trefferkreis: 9.48 mm
 Trefferlage: 0.67 mm rechts, 0.00 mm

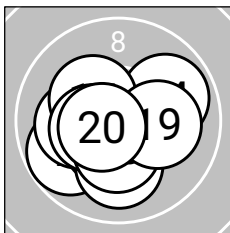

Serie 2: 102.2 (98)

9.8↖	10.5*↖	10.1←	9.9→	10.3*↖
10.1↓	10.4*↖	10.4*↓	10.1→	10.6*↖

beste Teiler: 91.0 (20.), 120.9 (12.), 136.3 (17.)
 Trefferkreis: 10.06 mm
 Trefferlage: 0.41 mm links, 0.52 mm tief

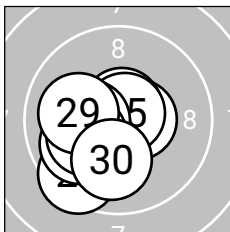

Serie 3: 102.2 (98)

9.5↖	10.5*→	10.3*↖	10.7*↑	10.7*↗
9.9↖	10.3*←	10.2*↖	10.0←	10.1↓

beste Teiler: 53.0 (25.), 69.9 (24.), 102.0 (22.)
 Trefferkreis: 8.97 mm
 Trefferlage: 0.96 mm links, 0.73 mm tief

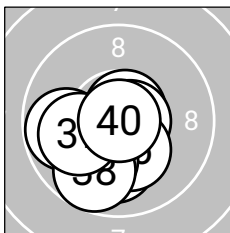

Serie 4: 102.6 (98)

10.7*↗	10.4*↖	9.8←	10.7*→	10.1↓
10.3*↓	10.0↖	9.7↓	10.0←	10.9*→

beste Teiler: 5.0 (40.), 63.0 (34.), 64.6 (31.)
 Trefferkreis: 8.33 mm
 Trefferlage: 0.69 mm links, 1.05 mm tief

LG 40 ZR

StandNr: 115

Tipotsch, Andrea #70819217

Senioren_1w

Wertung

StartNr: 200

01.03.2026 15:29

SG_Zell_am_Ziller

SG Zell am Ziller 1

Ergebnis: **418.1** (397)
 Serien: 105.4 104.5 103.3 104.9
 Zähler: 37 3 0 0 0 0 0 0 0 0
 Innenzehner: 36
 Weitester: 317 (30.), 264 (21.), 261 (12.)
 beste Teiler: 24.3 (29.), 43.1 (4.), 43.4 (39.)
 Trefferkreis: 9.85 mm
 Trefferlage: 0.06 mm links, 0.04 mm tief

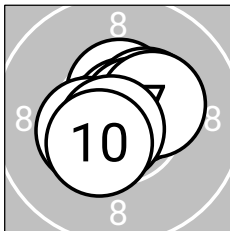
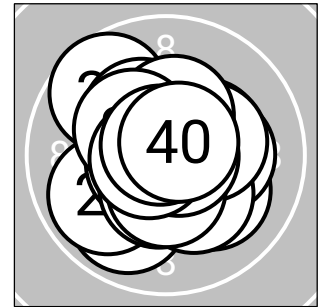

Serie 1: 105.4 (100)

10.5*↑	10.6*↙	10.6*↖	10.8*↗	10.4*↘
10.7*↗	10.3*↗	10.4*↖	10.7*↙	10.4*↙

beste Teiler: 43.1 (4.), 52.4 (9.), 75.1 (6.)
 Trefferkreis: 7.40 mm
 Trefferlage: 0.00 mm , 0.02 mm hoch

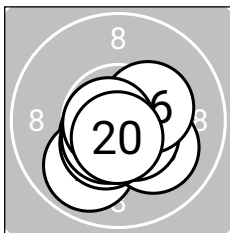

Serie 2: 104.5 (99)

10.6*↙	9.9↙	10.1↘	10.7*↖	10.5*↘
10.3*↗	10.4*↙	10.6*↙	10.8*↖	10.6*↓

beste Teiler: 50.2 (19.), 55.0 (14.), 84.2 (20.)
 Trefferkreis: 8.54 mm
 Trefferlage: 0.03 mm links, 0.75 mm tief

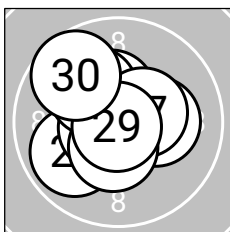

Serie 3: 103.3 (98)

9.9↙	10.6*↗	10.6*↖	10.2*→	10.4*↑
10.2*↖	10.4*↗	10.4*↓	10.9*↓	9.7↖

beste Teiler: 24.3 (29.), 81.9 (23.), 85.5 (22.)
 Trefferkreis: 9.47 mm
 Trefferlage: 0.33 mm links, 0.31 mm hoch

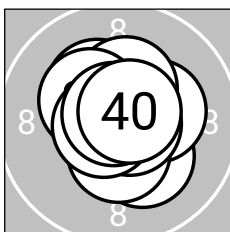

Serie 4: 104.9 (100)

10.2*↘	10.3*↗	10.3*↖	10.5*↓	10.8*→
10.3*↑	10.3*↖	10.7*↖	10.8*↖	10.7*↗

beste Teiler: 43.4 (39.), 50.1 (35.), 64.3 (38.)
 Trefferkreis: 7.95 mm
 Trefferlage: 0.09 mm rechts, 0.24 mm hoch

Ergebnis: **415.4** (398)
 Serien: 103.3 104.4 102.8 104.9
 Zähler: 38 2 0 0 0 0 0 0 0 0
 Innenzehner: 31
 Weitester: 270 (6.), 254 (5.), 244 (22.)
 beste Teiler: 20.2 (2.), 33.1 (35.), 55.0 (37.)
 Trefferkreis: 9.69 mm
 Trefferlage: 0.00 mm , 0.14 mm hoch

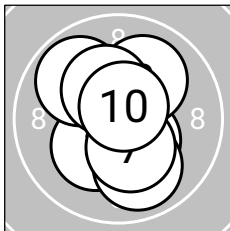
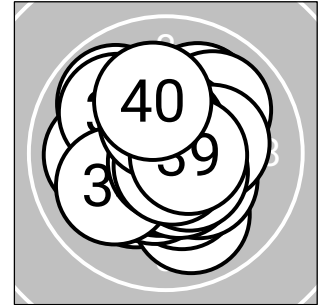

Serie 1: 103.3 (98)

10.7*←	10.9*→	10.2*↖	10.4*↘	9.9↘
9.9↘	10.3*↘	10.0↗	10.3*↖	10.7*↗

beste Teiler: 20.2 (2.), 65.7 (1.), 67.6 (10.)
 Trefferkreis: 9.65 mm
 Trefferlage: 0.01 mm links, 0.03 mm tief

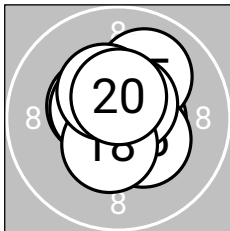

Serie 2: 104.4 (100)

10.7*↗	10.4*←	10.5*←	10.6*→	10.0↗
10.3*↘	10.6*↗	10.4*↘	10.4*↖	10.5*↑

beste Teiler: 57.9 (11.), 86.8 (17.), 95.1 (14.)
 Trefferkreis: 8.09 mm
 Trefferlage: 0.09 mm rechts, 0.42 mm hoch

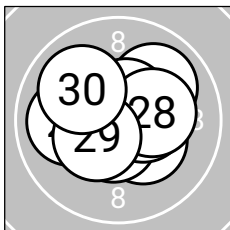

Serie 3: 102.8 (100)

10.3*↘	10.0↗	10.6*↘	10.6*↗	10.3*←
10.0←	10.4*→	10.2*→	10.4*↖	10.0↘

beste Teiler: 95.3 (23.), 97.1 (24.), 127.3 (27.)
 Trefferkreis: 9.07 mm
 Trefferlage: 0.08 mm links, 0.22 mm hoch

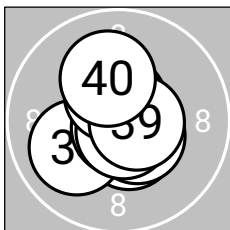

Serie 4: 104.9 (100)

10.6*↑	10.7*↘	10.5*↘	10.0←	10.8*↓
10.5*↘	10.7*↘	10.4*↑	10.6*→	10.1↑

beste Teiler: 33.1 (35.), 55.0 (37.), 73.0 (32.)
 Trefferkreis: 8.21 mm
 Trefferlage: 0.01 mm rechts, 0.04 mm tief



LG 40 ZR

StandNr: 117

Bichlmaier, Ramona #70819292**Senioren_1w**

Wertung

StartNr: 202

01.03.2026 15:28

SG_Thaur

SG Thaur 2

Ergebnis: **413.0** (393)
 Serien: 102.7 103.4 103.5 103.4
 Zähler: 33 7 0 0 0 0 0 0 0 0
 Innenzehner: 29
 Weitestе: 373 (12.), 367 (7.), 323 (27.)
 beste Teiler: 49.2 (3.), 50.0 (22.), 55.2 (19.)
 Trefferkreis: 11.13 mm
 Trefferlage: 0.23 mm rechts, 0.86 mm tief

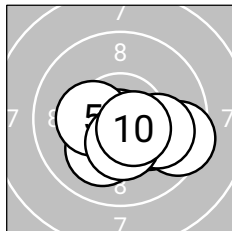
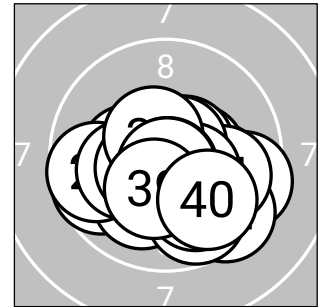
**Serie 1: 102.7** (99)

10.4*↙	10.1↙	10.8*↓	10.4*↘	10.3*←
10.2*↘	9.5↘	10.0↘	10.4*↓	10.6*↘

beste Teiler: 49.2 (3.), 99.4 (10.), 131.3 (4.)
 Trefferkreis: 9.76 mm
 Trefferlage: 0.54 mm rechts, 0.90 mm tief

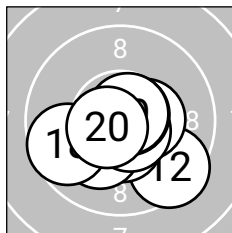
**Serie 2: 103.4** (98)

10.5*↘	9.5↘	10.4*→	10.5*↓	10.2*↙
10.6*↘	10.7*↗	9.7←	10.7*↗	10.6*←

beste Teiler: 55.2 (19.), 57.4 (17.), 79.2 (16.)
 Trefferkreis: 10.26 mm
 Trefferlage: 0.16 mm rechts, 0.75 mm tief

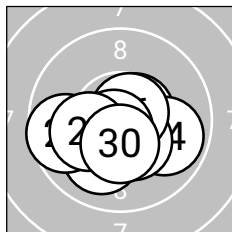
**Serie 3: 103.5** (98)

10.1↙	10.8*↓	10.6*↗	9.9↘	10.4*↘
10.7*↗	9.7←	10.7*↙	10.2*←	10.4*↓

beste Teiler: 50.0 (22.), 63.6 (28.), 68.1 (26.)
 Trefferkreis: 10.16 mm
 Trefferlage: 0.16 mm links, 0.69 mm tief

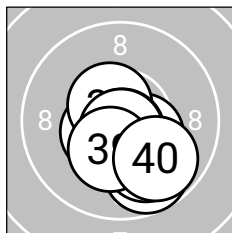
**Serie 4: 103.4** (98)

10.5*↓	10.5*↙	9.8↘	10.4*↘	10.6*↖
10.0↘	10.7*↓	10.7*↓	10.3*↙	9.9↘

beste Teiler: 55.9 (37.), 56.2 (38.), 100.9 (35.)
 Trefferkreis: 8.51 mm
 Trefferlage: 0.39 mm rechts, 1.09 mm tief

Ergebnis: 415.8 (397)
Serien: 100.9 103.9 105.8 105.2
Zähler: 37 3 0 0 0 0 0 0 0 0
Innenzehner: 31
Weiteste: 446 (6.), 352 (8.), 332 (3.)
beste Teiler: 9.4 (25.), 17.8 (7.), 36.2 (21.)
Trefferkreis: 10.78 mm
Trefferlage: 0.24 mm links, 0.31 mm hoch

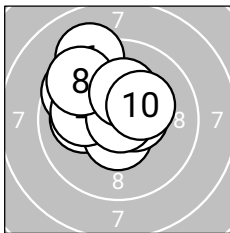
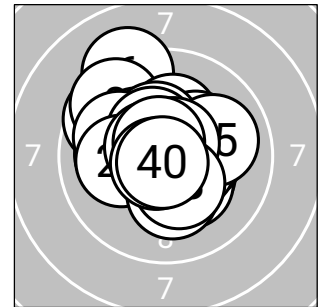

Serie 1: 100.9 (97)

10.1 ←	10.5* ↓	9.6 ↙	10.1 ←	10.5* →
9.2 ↗	10.9* ↗	9.5 ↘	10.2* ↑	10.3* ↗

beste Teiler: 17.8 (7.), 104.5 (5.), 105.0 (2.)
Trefferkreis: 9.93 mm
Trefferlage: 0.86 mm links, 1.09 mm hoch

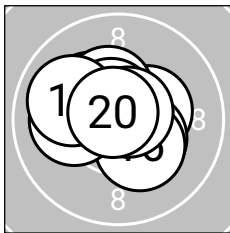

Serie 2: 103.9 (100)

10.2* ↙	10.4* →	10.4* ↗	10.4* ↘	10.6* ↗
10.3* ↘	10.1 ←	10.7* ↗	10.0 ←	10.8* ↙

beste Teiler: 44.2 (20.), 60.0 (18.), 87.2 (15.)
Trefferkreis: 8.55 mm
Trefferlage: 0.28 mm links, 0.30 mm hoch

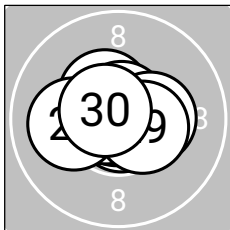

Serie 3: 105.8 (100)

10.8* ↘	10.4* ↗	10.8* ↑	10.7* ↑	10.9* ←
10.3* →	10.7* ←	10.1 ←	10.5* →	10.6* ↙

beste Teiler: 9.4 (25.), 36.2 (21.), 42.0 (23.)
Trefferkreis: 8.23 mm
Trefferlage: 0.11 mm links, 0.16 mm hoch

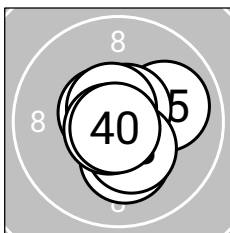

Serie 4: 105.2 (100)

10.6* ↙	10.7* ↓	10.4* ↘	10.2* ↓	10.0 →
10.7* ↗	10.7* ↗	10.4* ↘	10.7* ↙	10.8* ↘

beste Teiler: 36.2 (40.), 58.5 (32.), 59.8 (39.)
Trefferkreis: 7.96 mm
Trefferlage: 0.26 mm rechts, 0.31 mm tief



Ergebnis: **414.0** (397)
 Serien: 103.7 105.0 103.1 102.2
 Zähler: 37 3 0 0 0 0 0 0 0 0 0
 Innenzehner: 28
 Weitest: 340 (9.), 260 (10.), 254 (31.)
 beste Teiler: 24.3 (11.), 33.9 (16.), 34.8 (3.)
 Trefferkreis: 9.84 mm
 Trefferlage: 0.62 mm rechts, 0.07 mm hoch

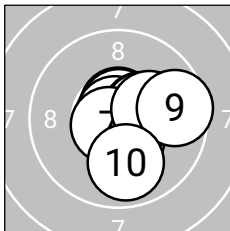
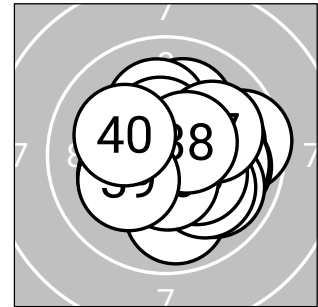

Serie 1: 103.7 (98)

10.6*↑	10.7*↑	10.8*↖	10.4*→	10.3*→
10.5*↓	10.7*↙	10.2*→	9.6→	9.9↓

beste Teiler: 34.8 (3.), 67.1 (7.), 69.1 (2.)
 Trefferkreis: 8.89 mm
 Trefferlage: 0.81 mm rechts, 0.01 mm tief

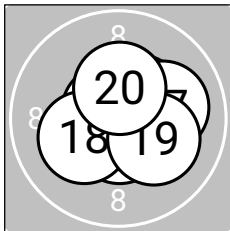

Serie 2: 105.0 (100)

10.9*↗	10.7*↖	10.6*↓	10.4*↗	10.7*↘
10.8*↘	10.1→	10.2*↙	10.2*↘	10.4*↑

beste Teiler: 24.3 (11.), 33.9 (16.), 62.8 (12.)
 Trefferkreis: 8.59 mm
 Trefferlage: 0.38 mm rechts, 0.01 mm hoch

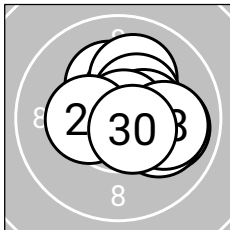

Serie 3: 103.1 (100)

10.3*↑	10.1↗	10.4*↗	10.4*→	10.0→
10.8*↗	10.1→	10.0→	10.4*←	10.6*↘

beste Teiler: 35.6 (26.), 92.6 (30.), 131.2 (24.)
 Trefferkreis: 8.51 mm
 Trefferlage: 0.88 mm rechts, 0.29 mm hoch

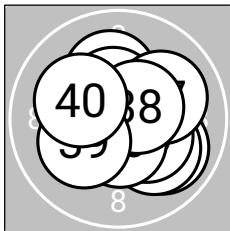

Serie 4: 102.2 (99)

9.9↘	10.1↘	10.3*↘	10.1↑	10.5*↑
10.5*↓	10.0→	10.5*↗	10.2*↙	10.1↖

beste Teiler: 107.3 (36.), 108.2 (38.), 123.5 (35.)
 Trefferkreis: 9.07 mm
 Trefferlage: 0.41 mm rechts, 0.01 mm tief



LG 40 ZR

StandNr: 120

Humer, Karin #70819084

Senioren_1w

Wertung

StartNr: 205

01.03.2026 15:25

SG_Matrei_a._Br.

SG Matrei a. Br. 2

Ergebnis: **418.7** (398)
 Serien: 104.9 104.4 104.6 104.8
 Zähler: 38 2 0 0 0 0 0 0 0 0 0
 Innenzehner: 32
 Weitester: 305 (12.), 254 (39.), 250 (2.)
 beste Teiler: 28.7 (17.), 43.0 (29.), 48.7 (6.)
 Trefferkreis: 9.76 mm
 Trefferlage: 0.09 mm rechts, 0.27 mm tief

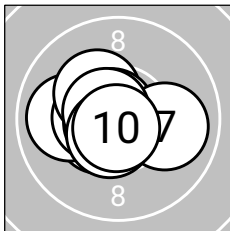
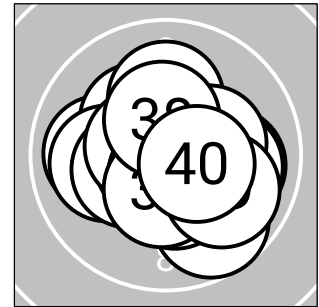

Serie 1: 104.9 (100)

10.5*↙	10.0←	10.5*←	10.3*↖	10.7*↙
10.8*↘	10.0→	10.7*↘	10.6*↘	10.8*↓

beste Teiler: 48.7 (6.), 49.2 (10.), 61.0 (5.)
 Trefferkreis: 9.42 mm
 Trefferlage: 0.54 mm links, 0.02 mm tief

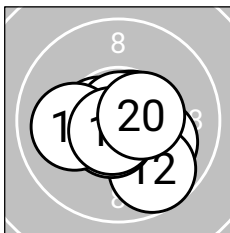

Serie 2: 104.4 (99)

10.1↘	9.7↘	10.7*↗	10.6*↘	10.7*←
10.6*←	10.8*↗	10.0←	10.7*↘	10.5*→

beste Teiler: 28.7 (17.), 57.0 (15.), 62.7 (19.)
 Trefferkreis: 9.06 mm
 Trefferlage: 0.10 mm rechts, 0.43 mm tief

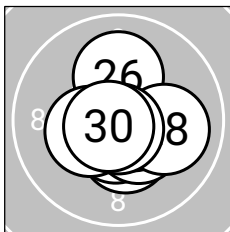

Serie 3: 104.6 (100)

10.4*↓	10.6*↓	10.4*↘	10.7*→	10.6*→
10.1↑	10.3*↙	10.0→	10.8*↓	10.7*↙

beste Teiler: 43.0 (29.), 57.1 (30.), 71.1 (24.)
 Trefferkreis: 8.48 mm
 Trefferlage: 0.30 mm rechts, 0.31 mm tief

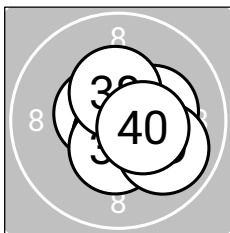

Serie 4: 104.8 (99)

10.6*↙	10.7*↓	10.3*→	10.6*↓	10.7*↘
10.7*↘	10.4*↓	10.4*↑	9.9↘	10.5*→

beste Teiler: 65.4 (36.), 74.0 (32.), 74.7 (35.)
 Trefferkreis: 8.10 mm
 Trefferlage: 0.50 mm rechts, 0.31 mm tief



LG 40 ZR

StandNr: 121

Amort, Monika #70819083

Senioren_1w

Wertung

StartNr: 206

01.03.2026 15:34

SG_Matrei_a._Br.

SG Matrei a. Br. 2

Ergebnis: **415.8** (397)
 Serien: 105.1 103.3 103.5 103.9
 Zähler: 38 1 1 0 0 0 0 0 0 0
 Innenzehner: 33
 Weitestе: 523 (22.), 258 (32.), 241 (16.)
 beste Teiler: 3.1 (27.), 34.1 (7.), 41.0 (29.)
 Trefferkreis: 11.27 mm
 Trefferlage: 0.10 mm rechts, 0.26 mm hoch

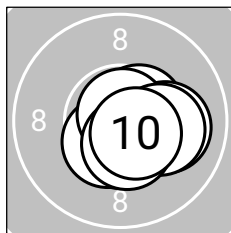
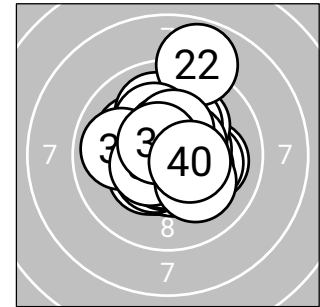
**Serie 1: 105.1** (100)

10.5*↗	10.5*↓	10.8*↗	10.1↗	10.6*↘
10.5*↙	10.8*↗	10.2*↗	10.5*↓	10.6*↘

beste Teiler: 34.1 (7.), 41.4 (3.), 85.1 (5.)
 Trefferkreis: 7.43 mm
 Trefferlage: 0.67 mm rechts, 0.42 mm tief

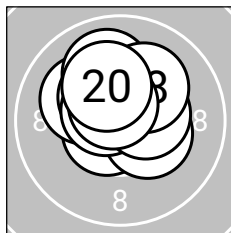
**Serie 2: 103.3** (100)

10.6*↙	10.3*↘	10.1↖	10.4*↖	10.6*↙
10.0↗	10.4*↗	10.1↗	10.6*↘	10.2*↖

beste Teiler: 83.6 (11.), 87.9 (15.), 89.5 (19.)
 Trefferkreis: 8.20 mm
 Trefferlage: 0.19 mm links, 0.83 mm hoch

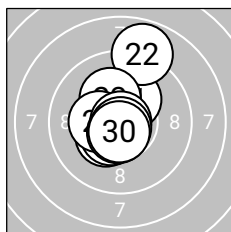
**Serie 3: 103.5** (98)

10.2*↗	8.9↗	10.2*↖	10.4*↙	10.5*↙
10.3*↖	10.9*↗	10.6*↓	10.8*↓	10.7*↓

beste Teiler: 3.1 (27.), 41.0 (29.), 71.5 (30.)
 Trefferkreis: 11.07 mm
 Trefferlage: 0.19 mm links, 0.46 mm hoch

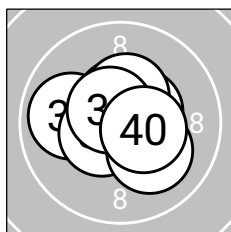
**Serie 4: 103.9** (99)

10.5*↑	9.9↖	10.4*↘	10.5*↙	10.5*↗
10.1↘	10.6*↗	10.4*↑	10.6*↖	10.4*↗

beste Teiler: 84.6 (39.), 88.2 (37.), 106.3 (31.)
 Trefferkreis: 8.96 mm
 Trefferlage: 0.13 mm rechts, 0.17 mm hoch

Ergebnis: **411.1 (393)**
Serien: 103.5 102.9 103.3 101.4
Zähler: 33 7 0 0 0 0 0 0 0 0
Innenzehner: 26
Weiteste: 361 (23.), 352 (32.), 313 (39.)
beste Teiler: 43.4 (21.), 49.5 (7.), 51.0 (35.)
Trefferkreis: 10.71 mm
Trefferlage: 0.19 mm links, 0.77 mm hoch

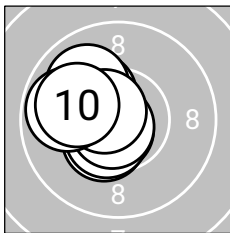
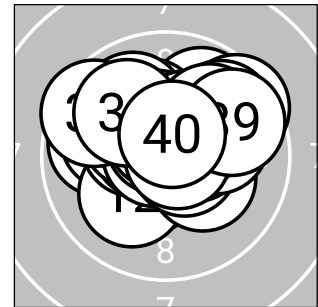

Serie 1: 103.5 (99)

10.4*↖	10.2*↖	10.7*↖	10.5*↖	10.5*↖
10.0↖	10.8*↖	10.6*↖	9.8↖	10.0↖

beste Teiler: 49.5 (7.), 63.5 (3.), 86.6 (8.)
Trefferkreis: 7.48 mm
Trefferlage: 1.17 mm links, 0.25 mm hoch

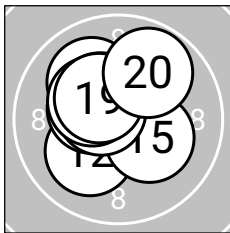

Serie 2: 102.9 (99)

10.7*↖	10.1↖	10.0↖	10.4*↖	10.2*↖
10.4*↖	10.6*↖	10.3*↖	10.4*↖	9.8↗

beste Teiler: 51.1 (11.), 97.0 (17.), 142.1 (14.)
Trefferkreis: 9.40 mm
Trefferlage: 0.56 mm links, 0.57 mm hoch

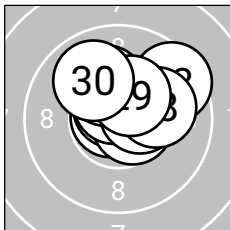

Serie 3: 103.3 (98)

10.8*↖	10.7*↖	9.5↗	10.6*↗	10.6*↖
10.5*↗	10.2*↖	10.1↗	10.4*↗	9.9↖

beste Teiler: 43.4 (21.), 69.8 (22.), 85.0 (24.)
Trefferkreis: 8.89 mm
Trefferlage: 0.47 mm rechts, 0.96 mm hoch

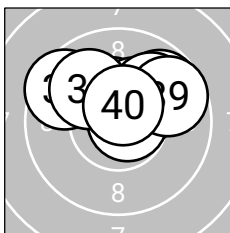

Serie 4: 101.4 (97)

10.4*↗	9.5↖	10.4*↖	10.3*↗	10.7*↗
9.8↗	10.0↗	10.0↖	9.7↗	10.6*↖

beste Teiler: 51.0 (35.), 95.8 (40.), 143.4 (33.)
Trefferkreis: 10.33 mm
Trefferlage: 0.47 mm rechts, 1.30 mm hoch



Ergebnis: **416.3** (398)
 Serien: 102.6 104.8 103.8 105.1
 Zähler: 38 2 0 0 0 0 0 0 0 0
 Innenzehner: 33
 Weitest: 328 (4.), 300 (5.), 231 (13.)
 beste Teiler: 8.0 (18.), 45.6 (31.), 56.3 (35.)
 Trefferkreis: 10.15 mm
 Trefferlage: 0.08 mm links, 0.01 mm hoch

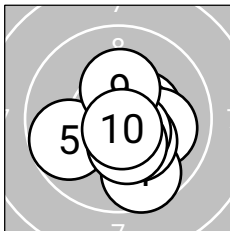
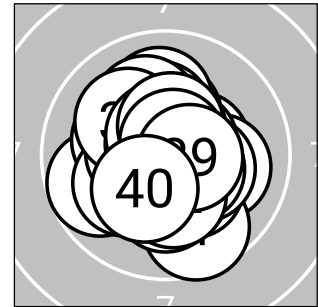

Serie 1: 102.6 (98)

10.4*↗	10.5*↗	10.1↗	9.6↘	9.8↖
10.3*↘	10.5*↘	10.4*↘	10.3*↑	10.7*↘

beste Teiler: 61.6 (10.), 101.8 (7.), 109.0 (2.)
 Trefferkreis: 9.68 mm
 Trefferlage: 0.56 mm rechts, 0.65 mm tief

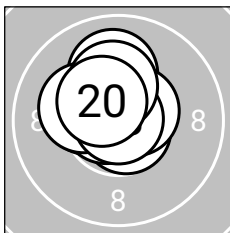

Serie 2: 104.8 (100)

10.3*↖	10.7*↘	10.0↑	10.7*↗	10.6*↗
10.7*↖	10.2*↖	10.9*↑	10.3*↑	10.4*↖

beste Teiler: 8.0 (18.), 56.5 (12.), 61.8 (16.)
 Trefferkreis: 7.39 mm
 Trefferlage: 0.37 mm links, 0.69 mm hoch

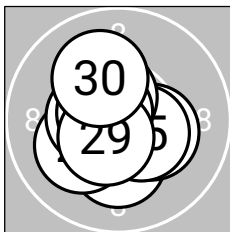

Serie 3: 103.8 (100)

10.2*↓	10.3*↖	10.1↖	10.3*↗	10.5*↘
10.5*↖	10.5*↖	10.7*↖	10.6*↖	10.1↖

beste Teiler: 72.9 (28.), 98.8 (29.), 114.7 (27.)
 Trefferkreis: 8.39 mm
 Trefferlage: 0.41 mm links, 0.22 mm tief

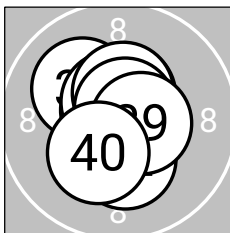

Serie 4: 105.1 (100)

10.8*↖	10.3*↓	10.1↖	10.5*↑	10.7*↖
10.6*↖	10.5*↑	10.7*↗	10.6*↗	10.3*↘

beste Teiler: 45.6 (31.), 56.3 (35.), 60.9 (38.)
 Trefferkreis: 8.12 mm
 Trefferlage: 0.14 mm links, 0.25 mm hoch



Ergebnis: **411.7 (394)**
 Serien: 102.5 103.5 103.2 102.5
 Zähler: 35 4 1 0 0 0 0 0 0 0
 Innenzehner: 31
 Weitestе: 541 (2.), 456 (24.), 384 (38.)
 beste Teiler: 34.6 (1.), 35.8 (21.), 43.8 (33.)
 Trefferkreis: 13.54 mm
 Trefferlage: 0.23 mm links, 0.00 mm

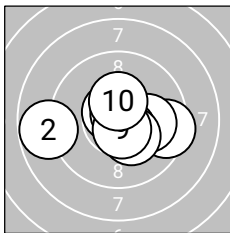
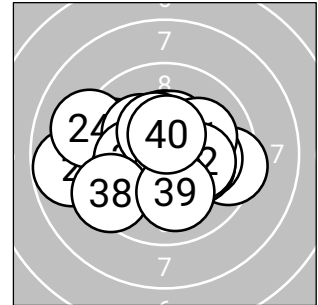

Serie 1: 102.5 (97)

10.8*↘ 8.8← 10.6*↖ 9.5→ 10.8*↑
 10.1→ 10.6*↘ 10.3*↘ 10.6*↓ 10.4*↑

beste Teiler: 34.6 (1.), 49.0 (5.), 78.1 (9.)
 Trefferkreis: 13.54 mm
 Trefferlage: 0.22 mm rechts, 0.21 mm tief

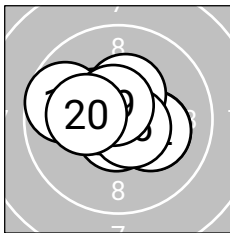

Serie 2: 103.5 (99)

10.2*↘ 10.2*↘ 10.7*↓ 10.4*↑ 10.5*←
 10.6*↘ 10.4*← 9.7← 10.6*↑ 10.2*←

beste Teiler: 64.9 (13.), 81.5 (16.), 82.8 (19.)
 Trefferkreis: 9.51 mm
 Trefferlage: 0.28 mm links, 0.19 mm hoch

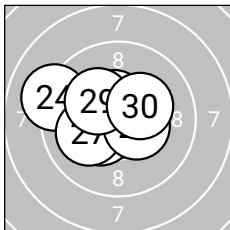

Serie 3: 103.2 (99)

10.8*↗ 10.7*↙ 10.7*↖ 9.1← 10.5*↑
 10.4*↙ 10.1← 10.4*↘ 10.2*↖ 10.3*↗

beste Teiler: 35.8 (21.), 55.2 (23.), 60.0 (22.)
 Trefferkreis: 10.42 mm
 Trefferlage: 0.68 mm links, 0.25 mm hoch

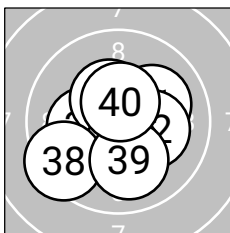

Serie 4: 102.5 (99)

10.1↗ 10.2*↘ 10.8*↖ 10.6*↖ 10.2*←
 10.4*↖ 10.3*↓ 9.4← 10.0↓ 10.5*↑

beste Teiler: 43.8 (33.), 98.4 (34.), 113.5 (40.)
 Trefferkreis: 10.49 mm
 Trefferlage: 0.20 mm links, 0.26 mm tief



Ergebnis: **411.6** (393)
 Serien: 102.2 104.7 100.0 104.7
 Zähler: 33 7 0 0 0 0 0 0 0 0
 Innenzehner: 29
 Weitest: 410 (23.), 405 (30.), 368 (7.)
 beste Teiler: 31.4 (32.), 40.6 (37.), 53.8 (34.)
 Trefferkreis: 12.29 mm
 Trefferlage: 0.05 mm links, 0.09 mm tief

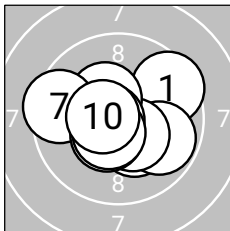
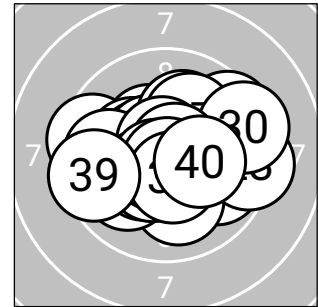

Serie 1: 102.2 (97)

9.5↗	10.3*↘	9.8↘	10.4*↘	10.4*↖
10.7*↖	9.5↖	10.5*↖	10.5*↖	10.6*↖

beste Teiler: 64.7 (6.), 96.8 (10.), 102.0 (9.)
 Trefferkreis: 11.31 mm
 Trefferlage: 0.01 mm rechts, 0.13 mm tief

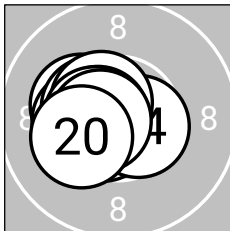

Serie 2: 104.7 (100)

10.3*↖	10.6*↖	10.3*↖	10.6*↗	10.5*↖
10.5*↖	10.6*↖	10.5*↖	10.6*↖	10.2*↖

beste Teiler: 80.7 (19.), 86.4 (12.), 90.1 (17.)
 Trefferkreis: 7.23 mm
 Trefferlage: 0.92 mm links, 0.00 mm

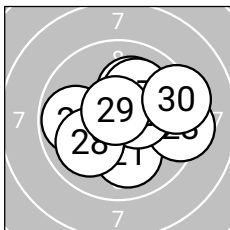

Serie 3: 100.0 (97)

10.1↓	10.2*↗	9.3→	10.4*↗	10.1↗
9.8↖	10.1↗	10.0↖	10.7*↖	9.3→

beste Teiler: 65.5 (29.), 131.8 (24.), 198.0 (22.)
 Trefferkreis: 11.40 mm
 Trefferlage: 0.86 mm rechts, 0.30 mm hoch

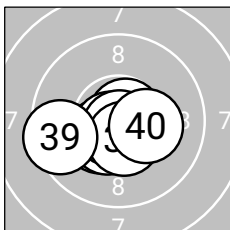

Serie 4: 104.7 (99)

10.4*↖	10.8*↗	10.5*↗	10.7*↗	10.5*↖
10.7*↖	10.8*↓	10.5*↓	9.5↖	10.3*↗

beste Teiler: 31.4 (32.), 40.6 (37.), 53.8 (34.)
 Trefferkreis: 9.75 mm
 Trefferlage: 0.18 mm links, 0.52 mm tief



LG 40 ZR

StandNr: 126

Kavelar, Christine #70819296

Senioren_1w

Wertung

StartNr: 211

01.03.2026 15:25

SG_Bruckhäusl

SG Bruckhäusl 2

Ergebnis: **410.3** (393)
 Serien: 103.8 102.5 101.7 102.3
 Zähler: 33 7 0 0 0 0 0 0 0 0 0
 Innenzehner: 28
 Weitest: 362 (23.), 360 (24.), 336 (31.)
 beste Teiler: 19.2 (28.), 42.7 (29.), 80.2 (13.)
 Trefferkreis: 10.85 mm
 Trefferlage: 0.46 mm links, 0.26 mm hoch

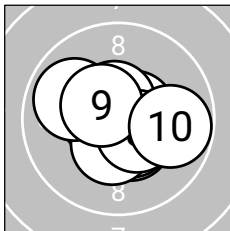
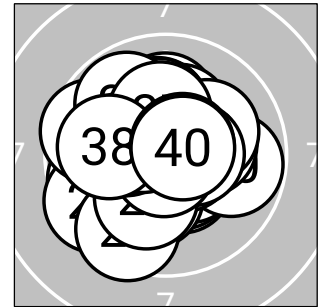

Serie 1: 103.8 (98)

10.4*↘	10.6*←	10.5*↘	10.4*↓	10.6*↗
9.9↙	10.6*↑	10.5*↗	10.5*↖	9.8↘

beste Teiler: 82.0 (2.), 93.1 (5.), 93.6 (7.)
 Trefferkreis: 9.93 mm
 Trefferlage: 0.13 mm rechts, 0.14 mm tief

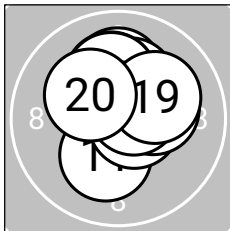

Serie 2: 102.5 (100)

10.2*↓	10.1↑	10.6*↗	10.2*↑	10.2*↗
10.1↑	10.6*↗	10.2*↑	10.1↗	10.2*↖

beste Teiler: 80.2 (13.), 88.8 (17.), 177.6 (15.)
 Trefferkreis: 8.56 mm
 Trefferlage: 0.28 mm rechts, 0.89 mm hoch

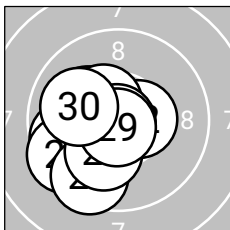

Serie 3: 101.7 (97)

9.7↙	10.5*↗	9.5↙	9.5↓	10.2*↓
10.2*↖	10.4*↖	10.9*↓	10.8*↓	10.0↙

beste Teiler: 19.2 (28.), 42.7 (29.), 116.1 (22.)
 Trefferkreis: 9.17 mm
 Trefferlage: 1.23 mm links, 0.60 mm tief

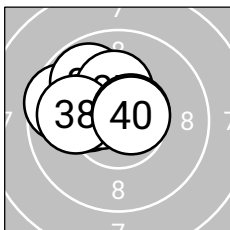

Serie 4: 102.3 (98)

9.6↙	10.5*↖	10.3*↖	9.8↖	10.2*↖
10.5*↖	10.2*↑	10.0←	10.6*↗	10.6*↗

beste Teiler: 80.2 (40.), 83.8 (39.), 108.2 (32.)
 Trefferkreis: 8.51 mm
 Trefferlage: 1.06 mm links, 0.90 mm hoch



Ergebnis: **410.9** (390)
 Serien: 103.2 102.6 103.1 102.0
 Zähler: 33 4 3 0 0 0 0 0 0 0
 Innenzehner: 32
 Weitester: 662 (33.), 619 (34.), 546 (19.)
 beste Teiler: 23.0 (35.), 26.4 (1.), 35.8 (37.)
 Trefferkreis: 16.69 mm
 Trefferlage: 0.05 mm rechts, 0.34 mm tief

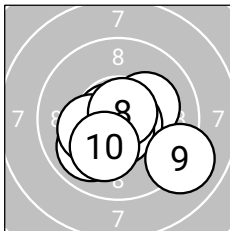
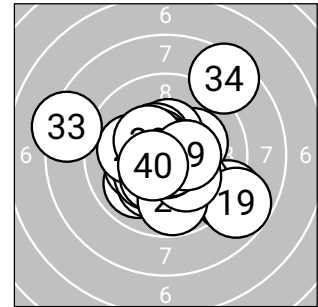

Serie 1: 103.2 (98)

10.8*↗	9.9↙	10.7*←	10.2*↖	10.2*↗
10.7*↘	10.6*↓	10.8*↗	9.1↘	10.2*↙

beste Teiler: 26.4 (1.), 48.8 (8.), 54.1 (3.)
 Trefferkreis: 10.52 mm
 Trefferlage: 0.19 mm rechts, 0.64 mm tief

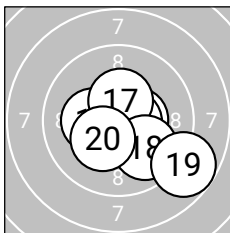

Serie 2: 102.6 (97)

10.6*↓	10.5*→	10.6*→	10.5*↖	10.7*↙
10.3*←	10.4*↑	9.9↘	8.8↘	10.3*↖

beste Teiler: 64.3 (15.), 79.4 (11.), 79.6 (13.)
 Trefferkreis: 11.47 mm
 Trefferlage: 0.47 mm rechts, 0.69 mm tief

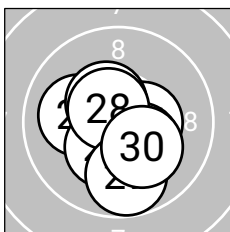

Serie 3: 103.1 (99)

10.5*↖	10.5*↓	10.1←	10.3*↖	10.4*→
10.3*↘	10.4*↖	10.6*↖	9.8↓	10.2*↘

beste Teiler: 90.6 (28.), 102.3 (22.), 112.4 (21.)
 Trefferkreis: 8.76 mm
 Trefferlage: 0.07 mm links, 0.64 mm tief

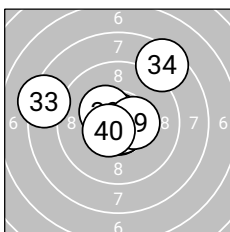

Serie 4: 102.0 (96)

10.7*↓	10.7*↖	8.3←	8.5↗	10.9*→
10.8*↘	10.8*↖	10.4*↖	10.4*→	10.5*↖

beste Teiler: 23.0 (35.), 35.8 (37.), 45.6 (36.)
 Trefferkreis: 15.08 mm
 Trefferlage: 0.35 mm links, 0.59 mm hoch



LG 40 ZR

StandNr: 128

Pfurtscheller, Barbara #70818822

Senioren_1w

Wertung

StartNr: 213

01.03.2026 15:25

SG_Fulpmes

Ergebnis: **420.1 (400)**
 Serien: 105.0 105.3 104.3 105.5
 Zähler: 40 0 0 0 0 0 0 0 0 0 0
 Innenzehner: 36
 Weitester: 234 (38.), 224 (30.), 211 (27.)
 beste Teiler: 17.0 (35.), 38.6 (1.), 43.0 (14.)
 Trefferkreis: 8.54 mm
 Trefferlage: 0.17 mm rechts, 0.15 mm tief

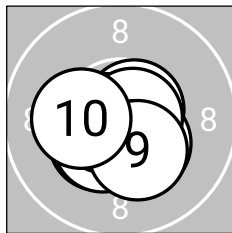
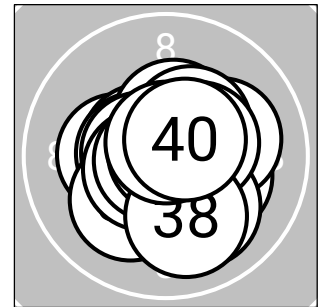
**Serie 1: 105.0 (100)**

10.8*↓	10.5*←	10.6*↗	10.4*↙	10.4*↙
10.7*←	10.4*↘	10.7*↗	10.3*↓	10.2*←

beste Teiler: 38.6 (1.), 56.5 (8.), 68.8 (6.)
 Trefferkreis: 7.44 mm
 Trefferlage: 0.22 mm links, 0.47 mm tief

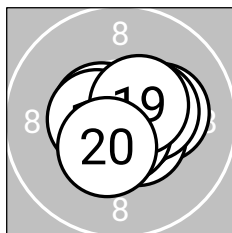
**Serie 2: 105.3 (100)**

10.7*↖	10.2*→	10.5*↘	10.8*↘	10.6*↖
10.4*→	10.7*↓	10.5*←	10.5*↗	10.4*↙

beste Teiler: 43.0 (14.), 52.4 (17.), 60.4 (11.)
 Trefferkreis: 7.45 mm
 Trefferlage: 0.22 mm rechts, 0.00 mm

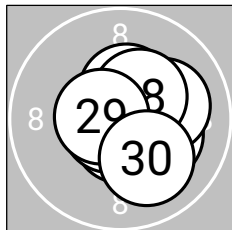
**Serie 3: 104.3 (100)**

10.6*↓	10.2*↘	10.7*←	10.6*↗	10.6*↗
10.4*↗	10.1*→	10.4*↗	10.6*←	10.1*↘

beste Teiler: 58.6 (23.), 76.0 (25.), 79.0 (21.)
 Trefferkreis: 7.81 mm
 Trefferlage: 0.54 mm rechts, 0.10 mm hoch

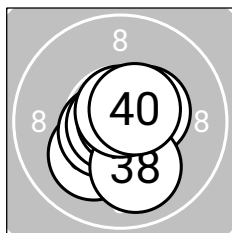
**Serie 4: 105.5 (100)**

10.1*↙	10.8*→	10.6*←	10.8*←	10.9*↗
10.5*↗	10.4*↗	10.0*↓	10.8*↑	10.6*↗

beste Teiler: 17.0 (35.), 44.0 (34.), 47.0 (32.)
 Trefferkreis: 7.79 mm
 Trefferlage: 0.17 mm rechts, 0.22 mm tief

Ergebnis: **411.3** (391)
 Serien: 103.2 102.1 102.7 103.3
 Zähler: 31 9 0 0 0 0 0 0 0 0
 Innenzehner: 24
 Weitestе: 368 (33.), 325 (10.), 306 (15.)
 beste Teiler: 27.0 (35.), 43.0 (31.), 44.5 (6.)
 Trefferkreis: 11.21 mm
 Trefferlage: 0.67 mm rechts, 0.23 mm tief

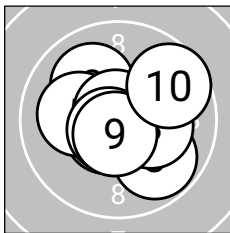
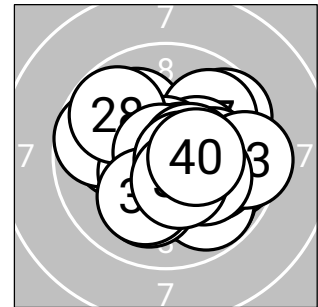

Serie 1: 103.2 (98)

10.7*→	10.0↖	9.8↘	10.6*↙	10.1←
10.8*↖	10.7*↙	10.2*→	10.6*↓	9.7↗

beste Teiler: 44.5 (6.), 63.1 (1.), 72.8 (7.)
 Trefferkreis: 9.79 mm
 Trefferlage: 0.21 mm rechts, 0.01 mm hoch

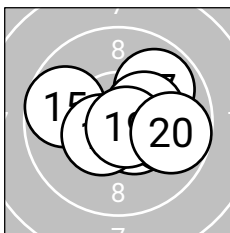

Serie 2: 102.1 (96)

10.6*→	10.2*→	10.5*↘	9.9→	9.7←
10.5*↙	9.9↗	10.3*→	10.7*↘	9.8→

beste Teiler: 54.4 (19.), 100.2 (11.), 113.4 (13.)
 Trefferkreis: 10.58 mm
 Trefferlage: 0.94 mm rechts, 0.02 mm hoch

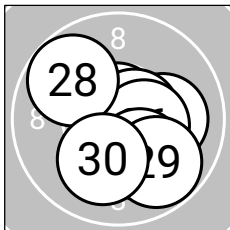

Serie 3: 102.7 (98)

10.1→	10.7*↖	10.6*↘	10.6*→	10.5*↓
10.4*→	10.1↘	9.8↖	9.8↘	10.1↙

beste Teiler: 53.7 (22.), 82.0 (24.), 86.3 (23.)
 Trefferkreis: 10.28 mm
 Trefferlage: 0.48 mm rechts, 0.51 mm tief

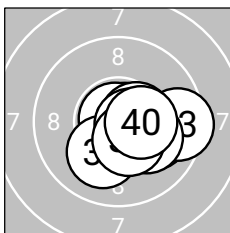

Serie 4: 103.3 (99)

10.8*→	10.0→	9.5→	10.2*↘	10.8*↖
10.5*→	10.1↙	10.6*→	10.4*↘	10.4*→

beste Teiler: 27.0 (35.), 43.0 (31.), 79.3 (38.)
 Trefferkreis: 9.43 mm
 Trefferlage: 1.07 mm rechts, 0.46 mm tief



LG 40 ZR

StandNr: 130

Mümmeler-Dadak, Claudia #70819222

Senioren_1w

Wertung

StartNr: 215

01.03.2026 15:26

SG_Fügenberg

SG Fügenberg 1

Ergebnis: **414.5** (394)
 Serien: 102.7 104.0 104.5 103.3
 Zähler: 34 6 0 0 0 0 0 0 0 0 0
 Innenzehner: 32
 Weitest: 379 (18.), 358 (9.), 307 (34.)
 beste Teiler: 37.2 (13.), 41.0 (25.), 46.0 (5.)
 Trefferkreis: 11.35 mm
 Trefferlage: 0.11 mm links, 0.19 mm hoch

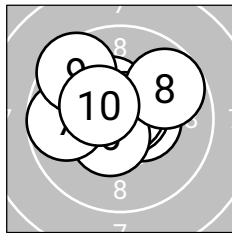
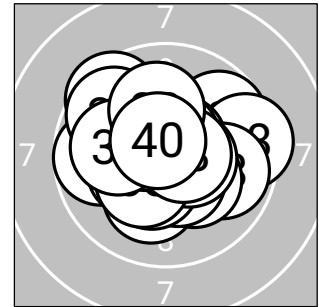
**Serie 1: 102.7** (97)

10.5*↖	10.5*→	10.4*↖	10.7*↗	10.8*↗
10.5*↙	9.7←	9.7↗	9.5↖	10.4*↖

beste Teiler: 46.0 (5.), 59.1 (4.), 110.3 (1.)
 Trefferkreis: 10.32 mm
 Trefferlage: 0.41 mm links, 0.65 mm hoch

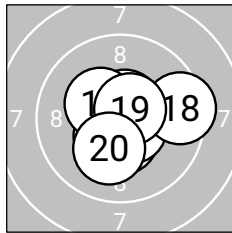
**Serie 2: 104.0** (99)

10.5*↓	10.4*↙	10.8*↑	10.6*↗	10.6*↗
10.6*↘	10.3*↖	9.4→	10.6*↗	10.2*↙

beste Teiler: 37.2 (13.), 79.6 (14.), 84.1 (19.)
 Trefferkreis: 9.77 mm
 Trefferlage: 0.31 mm rechts, 0.07 mm tief

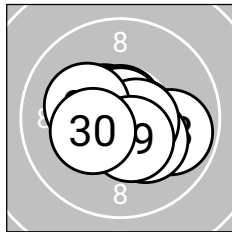
**Serie 3: 104.5** (99)

10.6*↖	10.6*→	9.9→	10.7*↑	10.8*↑
10.3*↘	10.6*→	10.2*↖	10.5*↘	10.3*↖

beste Teiler: 41.0 (25.), 53.0 (24.), 85.9 (27.)
 Trefferkreis: 9.10 mm
 Trefferlage: 0.22 mm rechts, 0.18 mm tief

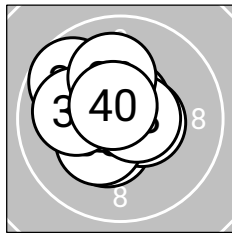
**Serie 4: 103.3** (99)

10.4*↙	10.5*→	10.3*↙	9.7↖	10.5*↖
10.6*↗	10.0←	10.6*→	10.1↑	10.6*↖

beste Teiler: 77.4 (40.), 82.2 (36.), 83.0 (38.)
 Trefferkreis: 8.59 mm
 Trefferlage: 0.58 mm links, 0.39 mm hoch

Ergebnis: **413.1** (393)
 Serien: 104.6 103.8 102.9 101.8
 Zähler: 34 5 1 0 0 0 0 0 0 0
 Innenzehner: 32
 Weitester: 510 (34.), 299 (30.), 294 (21.)
 beste Teiler: 33.1 (33.), 66.6 (4.), 69.2 (20.)
 Trefferkreis: 11.34 mm
 Trefferlage: 0.02 mm links, 0.26 mm tief

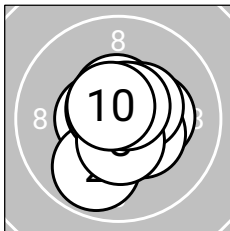
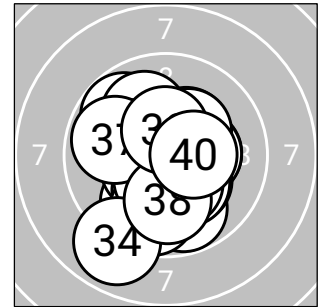

Serie 1: 104.6 (99)

10.5*←	9.9↙	10.3*→	10.7*↖	10.4*↗
10.5*↑	10.5*↗	10.5*↓	10.6*↗	10.7*↖

beste Teiler: 66.6 (4.), 75.2 (10.), 77.1 (9.)
 Trefferkreis: 8.36 mm
 Trefferlage: 0.14 mm rechts, 0.07 mm tief

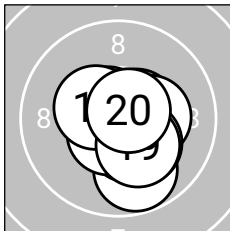

Serie 2: 103.8 (99)

10.5*↗	10.3*→	9.8↘	10.4*↘	10.6*↖
10.6*↙	10.4*↖	10.3*↗	10.2*↘	10.7*↗

beste Teiler: 69.2 (20.), 76.3 (15.), 93.1 (16.)
 Trefferkreis: 8.46 mm
 Trefferlage: 0.46 mm rechts, 0.53 mm tief

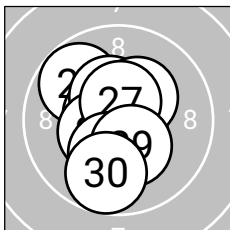

Serie 3: 102.9 (98)

9.8↖	10.6*←	10.6*↘	10.4*↖	10.3*↗
10.4*↖	10.5*↑	10.2*↓	10.3*↘	9.8↘

beste Teiler: 81.4 (23.), 87.3 (22.), 102.7 (27.)
 Trefferkreis: 9.71 mm
 Trefferlage: 0.33 mm links, 0.15 mm tief

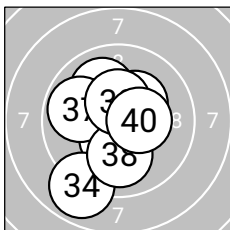

Serie 4: 101.8 (97)

10.4*↙	10.3*↗	10.8*↑	8.9↙	10.7*↘
10.0↖	9.9↖	10.0↓	10.4*↑	10.4*→

beste Teiler: 33.1 (33.), 71.4 (35.), 129.0 (39.)
 Trefferkreis: 11.31 mm
 Trefferlage: 0.35 mm links, 0.27 mm tief

LG 40 ZR

StandNr: 132

Lettenbichler, Elisabeth #70819223

Senioren_1w

Wertung

StartNr: 217

01.03.2026 15:47

SG_Breitenbach

SG Breitenbach 1

Ergebnis: **406.4** (387)
 Serien: 103.7 104.1 104.7 93.9
 Zähler: 36 3 0 0 0 0 0 0 0 0 1
 Innenzehner: 33
 Weitestе: 6173 (35.), 297 (6.), 289 (7.)
 beste Teiler: 42.4 (32.), 49.8 (27.), 56.8 (31.)
 Trefferkreis: 69.06 mm
 Trefferlage: 0.82 mm rechts, 1.03 mm tief

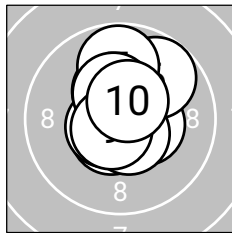
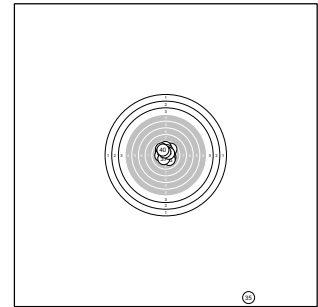
**Serie 1: 103.7** (98)

10.4*➔	10.6*↙	10.6*↙	10.6*↘	10.3*↗
9.8↗	9.8↗	10.4*↗	10.7*↙	10.5*↗

beste Teiler: 71.5 (9.), 89.0 (3.), 94.5 (4.)
 Trefferkreis: 8.50 mm
 Trefferlage: 0.14 mm rechts, 0.61 mm hoch

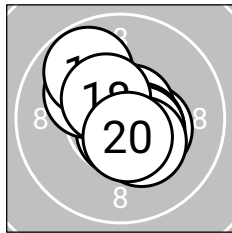
**Serie 2: 104.1** (99)

10.4*➔	10.7*↗	10.7*↓	10.5*➔	10.5*➔
10.1↙	9.8↙	10.5*↙	10.3*↘	10.6*↘

beste Teiler: 63.0 (13.), 66.4 (12.), 100.0 (20.)
 Trefferkreis: 8.91 mm
 Trefferlage: 0.13 mm rechts, 0.07 mm hoch

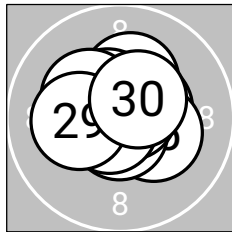
**Serie 3: 104.7** (100)

10.2*↗	10.5*↙	10.3*↙	10.5*➔	10.3*➔
10.7*↓	10.8*↗	10.7*↙	10.2*←	10.5*↗

beste Teiler: 49.8 (27.), 58.8 (28.), 61.1 (26.)
 Trefferkreis: 8.08 mm
 Trefferlage: 0.01 mm links, 0.34 mm hoch

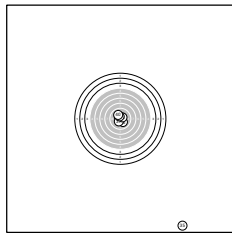
**Serie 4: 93.9** (90)

10.7*↘	10.8*↓	10.6*↙	10.4*↙	0.0↘
10.1↘	10.3*↙	10.4*↗	10.5*↗	10.1↙

beste Teiler: 42.4 (32.), 56.8 (31.), 80.6 (33.)
 Trefferkreis: 68.43 mm
 Trefferlage: 3.04 mm rechts, 5.16 mm tief

Ergebnis: **419.8** (398)
 Serien: 102.3 105.6 106.9 105.0
 Zähler: 38 2 0 0 0 0 0 0 0 0
 Innenzehner: 34
 Weitester: 278 (8.), 263 (36.), 245 (10.)
 beste Teiler: 4.1 (20.), 6.0 (21.), 12.6 (28.)
 Trefferkreis: 9.58 mm
 Trefferlage: 0.01 mm rechts, 0.22 mm hoch

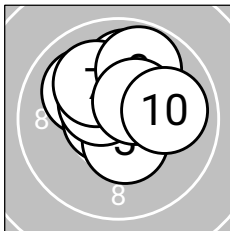
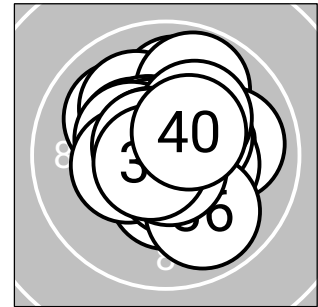

Serie 1: 102.3 (99)

10.0 ↖	10.7* ←	10.5* ↓	10.0 ↑	10.3* ↗
10.5* ↖	10.1 ↖	9.8 ↗	10.4* ↗	10.0 →

beste Teiler: 66.0 (2.), 118.5 (3.), 124.4 (6.)
 Trefferkreis: 8.80 mm
 Trefferlage: 0.16 mm rechts, 1.07 mm hoch

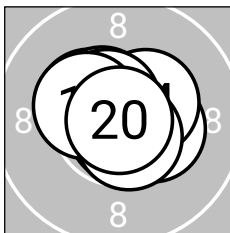

Serie 2: 105.6 (100)

10.4* →	10.6* ↗	10.4* ↖	10.4* ↗	10.5* ↖
10.8* ↓	10.6* ↖	10.4* ↖	10.6* ↓	10.9* →

beste Teiler: 4.1 (20.), 41.2 (16.), 81.5 (19.)
 Trefferkreis: 7.44 mm
 Trefferlage: 0.03 mm rechts, 0.28 mm hoch

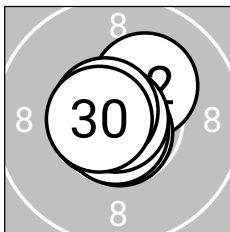

Serie 3: 106.9 (100)

10.9* ↓	10.2* ↗	10.7* ←	10.7* ↓	10.7* ←
10.7* ←	10.8* ↓	10.9* ←	10.7* ↖	10.6* ←

beste Teiler: 6.0 (21.), 12.6 (28.), 49.4 (27.)
 Trefferkreis: 6.92 mm
 Trefferlage: 0.23 mm links, 0.08 mm hoch

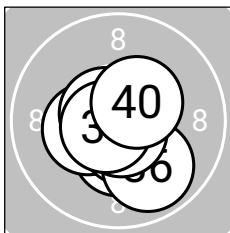

Serie 4: 105.0 (99)

10.5* ↓	10.4* ↓	10.3* ←	10.8* →	10.6* ↓
9.9 ↓	10.7* ↓	10.7* ↖	10.7* ↖	10.4* ↗

beste Teiler: 44.0 (34.), 52.2 (37.), 65.7 (39.)
 Trefferkreis: 8.13 mm
 Trefferlage: 0.09 mm rechts, 0.55 mm tief



Ergebnis: 416.1 (398)
Serien: 104.6 103.6 104.7 103.2
Zähler: 38 2 0 0 0 0 0 0 0 0
Innenzehner: 34
Weiteste: 272 (7.), 253 (35.), 236 (39.)
beste Teiler: 8.9 (9.), 32.2 (3.), 57.6 (29.)
Trefferkreis: 9.13 mm
Trefferlage: 0.14 mm rechts, 0.05 mm tief

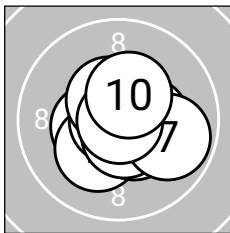
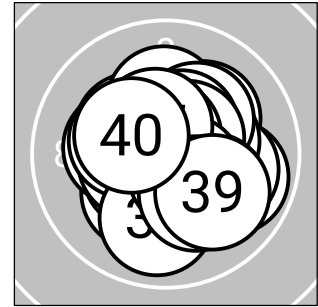

Serie 1: 104.6 (99)

10.4*←	10.2*↙	10.8*←	10.4*→	10.5*↘
10.6*↘	9.9*→	10.5*↗	10.9*↘	10.4*↗

beste Teiler: 8.9 (9.), 32.2 (3.), 86.1 (6.)
Trefferkreis: 8.41 mm
Trefferlage: 0.26 mm rechts, 0.22 mm tief

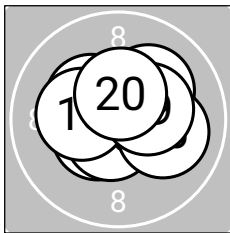

Serie 2: 103.6 (100)

10.5*↙	10.1*↗	10.5*↖	10.6*←	10.6*↘
10.0*→	10.3*↖	10.2*←	10.3*→	10.5*↑

beste Teiler: 76.3 (14.), 82.7 (15.), 110.9 (13.)
Trefferkreis: 8.55 mm
Trefferlage: 0.09 mm links, 0.25 mm hoch

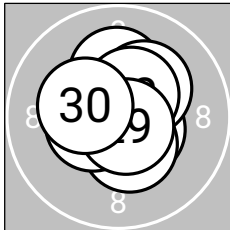

Serie 3: 104.7 (100)

10.7*↘	10.5*↘	10.2*↑	10.7*←	10.4*↘
10.5*←	10.2*↗	10.5*↗	10.7*↘	10.3*←

beste Teiler: 57.6 (29.), 63.0 (24.), 67.1 (21.)
Trefferkreis: 7.84 mm
Trefferlage: 0.06 mm rechts, 0.16 mm hoch

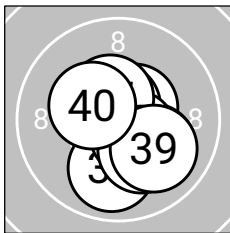

Serie 4: 103.2 (99)

10.5*↗	10.6*←	10.7*↑	10.0*↘	9.9*↓
10.5*↘	10.5*↖	10.2*↘	10.0*↘	10.3*←

beste Teiler: 69.3 (33.), 81.5 (32.), 104.2 (31.)
Trefferkreis: 8.42 mm
Trefferlage: 0.34 mm rechts, 0.42 mm tief

