

LG 40 ZR

StandNr: 111

Pfandler, Elisabeth #70819303

Senioren_2w

Wertung

StartNr: 244

01.03.2026 16:55

SG_Zams

SG Zams 1

Ergebnis: **414.8** (399)
 Serien: 103.6 104.2 104.1 102.9
 Zähler: 39 1 0 0 0 0 0 0 0 0
 Innenzehner: 33
 Weitester: 336 (10.), 249 (13.), 240 (40.)
 beste Teiler: 33.2 (20.), 50.6 (29.), 63.9 (39.)
 Trefferkreis: 10.12 mm
 Trefferlage: 0.37 mm links, 0.05 mm hoch

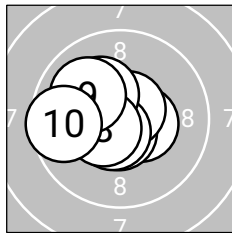
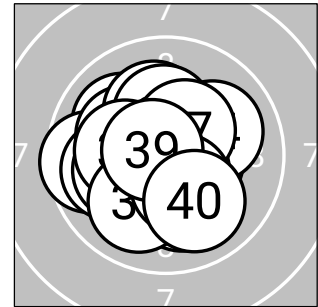
**Serie 1: 103.6** (99)

10.5*→	10.7*↖	10.2*↖	10.6*↓	10.7*↗
10.6*↘	10.2*↖	10.5*↖	10.0↖	9.6↖

beste Teiler: 64.3 (2.), 71.4 (5.), 79.4 (4.)
 Trefferkreis: 9.04 mm
 Trefferlage: 0.81 mm links, 0.14 mm hoch

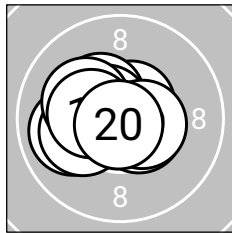
**Serie 2: 104.2** (100)

10.5*→	10.6*↗	10.0↖	10.2*↖	10.4*↖
10.6*↖	10.2*↖	10.4*↖	10.5*→	10.8*↓

beste Teiler: 33.2 (20.), 86.8 (12.), 88.2 (16.)
 Trefferkreis: 8.05 mm
 Trefferlage: 0.67 mm links, 0.08 mm hoch

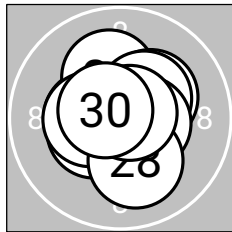
**Serie 3: 104.1** (100)

10.4*↖	10.4*↖	10.2*↑	10.3*↗	10.4*↗
10.4*↖	10.5*→	10.1↓	10.8*↗	10.6*↖

beste Teiler: 50.6 (29.), 80.0 (30.), 112.5 (27.)
 Trefferkreis: 8.63 mm
 Trefferlage: 0.04 mm links, 0.16 mm hoch

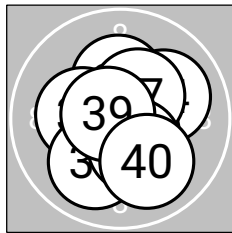
**Serie 4: 102.9** (100)

10.4*↖	10.2*↑	10.2*↖	10.0↗	10.0↘
10.6*↘	10.4*↗	10.4*↘	10.7*↖	10.0↘

beste Teiler: 63.9 (39.), 87.2 (36.), 138.4 (37.)
 Trefferkreis: 9.02 mm
 Trefferlage: 0.02 mm rechts, 0.16 mm tief

LG 40 ZR

StandNr: 112

Wagner, Andrea #70819237

Senioren_2w

Wertung

StartNr: 245

01.03.2026 16:54

SG_Westendorf

SG Westendorf 1

Ergebnis: **414.1** (394)
 Serien: 104.3 103.4 103.1 103.3
 Zähler: 34 6 0 0 0 0 0 0 0 0
 Innenzehner: 33
 Weitestе: 447 (38.), 349 (26.), 330 (31.)
 beste Teiler: 13.0 (37.), 22.1 (20.), 33.2 (13.)
 Trefferkreis: 11.09 mm
 Trefferlage: 0.54 mm rechts, 0.22 mm hoch

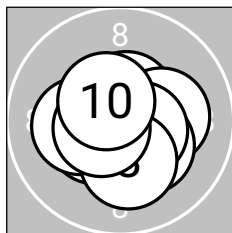
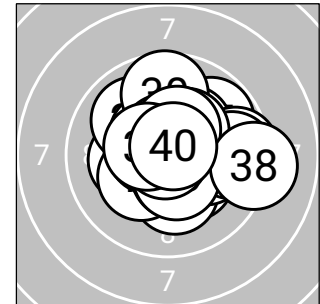
**Serie 1: 104.3** (100)

10.6*↗	10.4*↖	10.7*↘	10.2*↗	10.3*↘
10.6*↘	10.2*↖	10.2*↘	10.6*↖	10.5*↖

beste Teiler: 60.1 (3.), 93.0 (9.), 97.4 (6.)
 Trefferkreis: 8.28 mm
 Trefferlage: 0.06 mm rechts, 0.27 mm tief

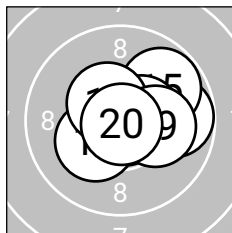
**Serie 2: 103.4** (98)

9.8→	10.5*↗	10.8*↘	10.2*↗	9.8↗
10.2*↖	10.5*↗	10.5*↖	10.2*↗	10.9*↘

beste Teiler: 22.1 (20.), 33.2 (13.), 105.4 (12.)
 Trefferkreis: 9.14 mm
 Trefferlage: 0.91 mm rechts, 0.23 mm hoch

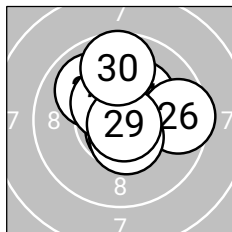
**Serie 3: 103.1** (98)

10.7*↗	10.7*↘	10.4*↗	10.3*↗	10.0↖
9.6→	10.4*↖	10.5*↘	10.8*↘	9.7↗

beste Teiler: 33.2 (29.), 57.9 (21.), 59.6 (22.)
 Trefferkreis: 9.93 mm
 Trefferlage: 0.45 mm rechts, 0.63 mm hoch

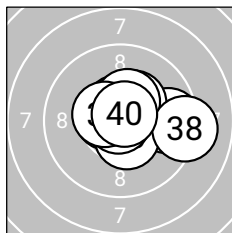
**Serie 4: 103.3** (98)

9.6→	10.6*↗	10.3*↗	10.6*↖	10.5*↘
10.4*↗	10.9*↖	9.2→	10.5*↖	10.7*↗

beste Teiler: 13.0 (37.), 53.8 (40.), 91.2 (34.)
 Trefferkreis: 10.09 mm
 Trefferlage: 0.76 mm rechts, 0.29 mm hoch

Ergebnis: 411.3 (394)
Serien: 101.3 103.6 103.6 102.8
Zähler: 34 6 0 0 0 0 0 0 0 0
Innenzehner: 26
Weiteste: 467 (1.), 384 (26.), 353 (17.)
beste Teiler: 26.0 (27.), 43.6 (11.), 56.6 (16.)
Trefferkreis: 13.00 mm
Trefferlage: 0.07 mm links, 0.14 mm tief

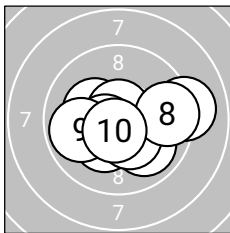
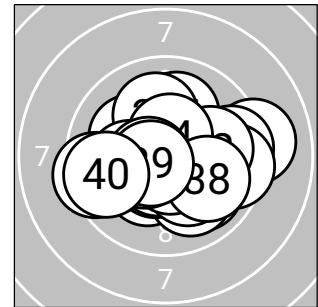

Serie 1: 101.3 (97)

9.1 →	10.2* ←	10.0 ↘	10.3* ↙	10.4* ↘
10.7* ↑	10.5* ←	9.6 →	9.9 ←	10.6* ↘

beste Teiler: 58.0 (6.), 80.6 (10.), 104.2 (7.)
Trefferkreis: 11.87 mm
Trefferlage: 0.42 mm rechts, 0.39 mm tief

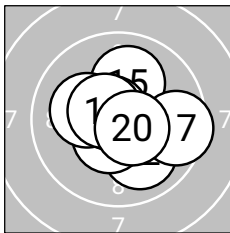

Serie 2: 103.6 (99)

10.8* ←	10.0 ↘	10.5* ↙	10.6* →	10.1 ↑
10.7* ←	9.5 →	10.2* ←	10.6* ←	10.6* ↘

beste Teiler: 43.6 (11.), 56.6 (16.), 96.5 (19.)
Trefferkreis: 9.99 mm
Trefferlage: 0.29 mm rechts, 0.01 mm tief

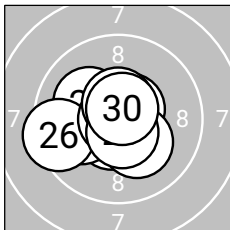

Serie 3: 103.6 (99)

10.6* ↙	10.0 ←	10.1 ←	10.6* →	10.2* ↘
9.4 ←	10.8* ←	10.6* ↑	10.6* ↘	10.7* ↑

beste Teiler: 26.0 (27.), 67.4 (30.), 85.7 (29.)
Trefferkreis: 9.42 mm
Trefferlage: 0.62 mm links, 0.15 mm tief

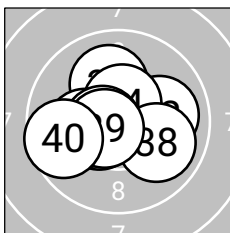

Serie 4: 102.8 (99)

10.1 ↑	10.0 →	10.7* ←	10.5* ↑	10.5* ←
10.2* ←	10.6* ←	10.0 ↘	10.6* ←	9.6 ←

beste Teiler: 66.0 (33.), 88.1 (39.), 93.1 (37.)
Trefferkreis: 10.16 mm
Trefferlage: 0.42 mm links, 0.02 mm tief



Ergebnis: **413.0** (394)
 Serien: 99.8 105.2 102.9 105.1
 Zähler: 34 6 0 0 0 0 0 0 0 0
 Innenzehner: 27
 Weitest: 403 (8.), 351 (4.), 340 (25.)
 beste Teiler: 26.9 (33.), 41.3 (39.), 41.4 (38.)
 Trefferkreis: 11.93 mm
 Trefferlage: 0.05 mm rechts, 0.10 mm tief

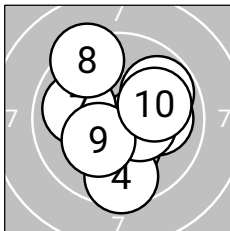
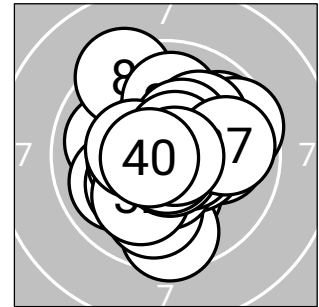

Serie 1: 99.8 (97)
 10.0➔ 10.3*⚡ 10.3*⚡ 9.5⚡ 10.4*➔
 9.8➔ 10.0⚡ 9.3⚡ 10.2*⚡ 10.0➔
 beste Teiler: 135.0 (5.), 166.7 (2.), 174.9 (3.)
 Trefferkreis: 11.87 mm
 Trefferlage: 0.23 mm rechts, 0.15 mm tief

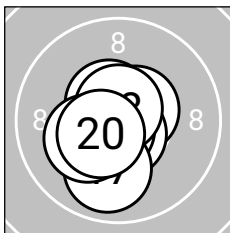

Serie 2: 105.2 (99)
 10.7*⚡ 10.5*➔ 10.7*⚡ 10.7*⬆ 10.6*⚡
 10.7*⚡ 9.9⚡ 10.7*⬆ 10.2*⚡ 10.5*⚡
 beste Teiler: 51.7 (11.), 58.1 (16.), 58.2 (14.)
 Trefferkreis: 7.90 mm
 Trefferlage: 0.33 mm links, 0.25 mm tief

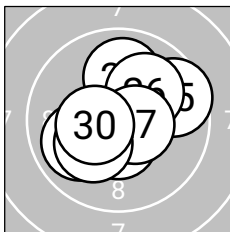

Serie 3: 102.9 (99)
 10.7*⚡ 10.5*⚡ 10.8*➔ 10.0⬆ 9.6➔
 10.1➔ 10.6*➔ 10.0⚡ 10.2*⚡ 10.4*⚡
 beste Teiler: 50.9 (23.), 53.7 (21.), 100.4 (27.)
 Trefferkreis: 10.40 mm
 Trefferlage: 0.17 mm rechts, 0.05 mm hoch

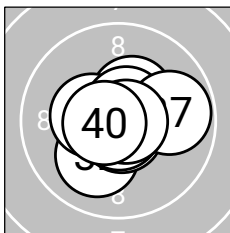

Serie 4: 105.1 (99)
 10.4*⬆ 10.1⚡ 10.8*⚡ 10.7*⚡ 10.4*⚡
 10.6*⬆ 9.8➔ 10.8*⚡ 10.8*➔ 10.7*⚡
 beste Teiler: 26.9 (33.), 41.3 (39.), 41.4 (38.)
 Trefferkreis: 9.03 mm
 Trefferlage: 0.13 mm rechts, 0.06 mm tief



Ergebnis: **417.3** (396)
 Serien: 104.4 103.9 103.1 105.9
 Zähler: 36 4 0 0 0 0 0 0 0 0
 Innenzehner: 34
 Weitester: 331 (27.), 327 (18.), 279 (29.)
 beste Teiler: 13.3 (20.), 13.3 (36.), 28.0 (25.)
 Trefferkreis: 9.70 mm
 Trefferlage: 0.03 mm links, 0.01 mm hoch

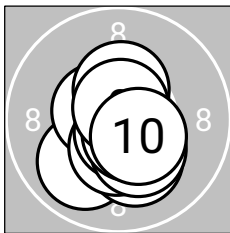
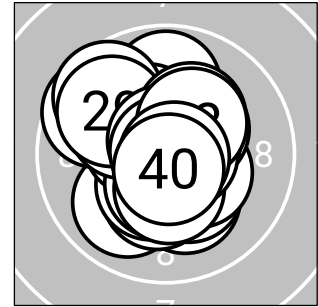

Serie 1: 104.4 (100)

10.0 ↘	10.2* ↘	10.6* ↘	10.4* ↓	10.7* ↓
10.4* ↑	10.3* ↘	10.6* ↘	10.7* ↑	10.5* ↘

beste Teiler: 59.0 (9.), 60.7 (5.), 83.6 (8.)
 Trefferkreis: 8.29 mm
 Trefferlage: 0.11 mm rechts, 0.59 mm tief

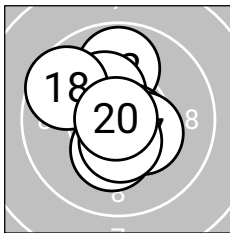

Serie 2: 103.9 (98)

10.8* →	9.8 ↑	10.3* ↘	10.3* ↓	10.6* ↘
10.7* ↘	10.4* ↘	9.6 ↘	10.5* ↓	10.9* ↘

beste Teiler: 13.3 (20.), 37.6 (11.), 71.5 (16.)
 Trefferkreis: 9.26 mm
 Trefferlage: 0.10 mm links, 0.12 mm hoch

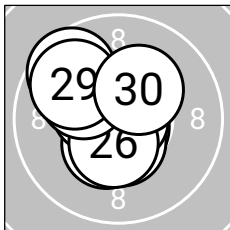

Serie 3: 103.1 (98)

10.4* ↘	10.7* ↘	10.5* ↓	10.5* ↘	10.8* →
10.5* ↓	9.6 ↘	10.1 ↘	9.8 ↘	10.2* ↗

beste Teiler: 28.0 (25.), 53.8 (22.), 113.9 (23.)
 Trefferkreis: 8.79 mm
 Trefferlage: 0.64 mm links, 0.33 mm hoch

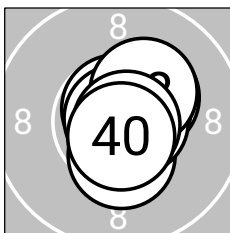

Serie 4: 105.9 (100)

10.3* ↗	10.4* ↓	10.5* ↗	10.7* ↑	10.6* ↗
10.9* ↑	10.7* →	10.3* ↗	10.8* →	10.7* ↓

beste Teiler: 13.3 (36.), 36.4 (39.), 56.5 (34.)
 Trefferkreis: 7.31 mm
 Trefferlage: 0.49 mm rechts, 0.19 mm hoch

Ergebnis: 416.8 (395)
Serien: 104.5 104.2 103.1 105.0
Zähler: 35 5 0 0 0 0 0 0 0 0
Innenzehner: 33
Weiteste: 318 (25.), 304 (26.), 290 (30.)
beste Teiler: 22.0 (18.), 24.0 (31.), 25.0 (22.)
Trefferkreis: 9.78 mm
Trefferlage: 0.05 mm links, 0.44 mm hoch

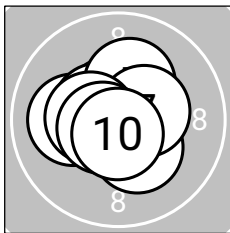
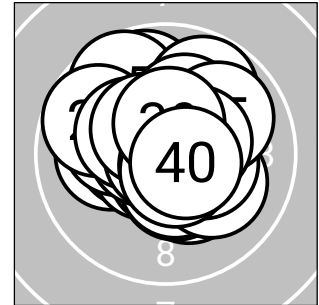

Serie 1: 104.5 (100)

10.1 ←	10.6* ↖	10.5* ↖	10.7* ↗	10.2* ↗
10.3* ↘	10.4* →	10.4* ←	10.6* ↖	10.7* ↓

beste Teiler: 59.1 (4.), 70.1 (10.), 86.7 (9.)
Trefferkreis: 8.29 mm
Trefferlage: 0.26 mm links, 0.16 mm hoch

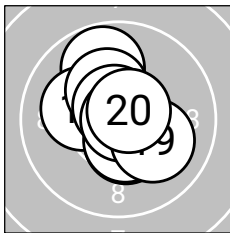

Serie 2: 104.2 (99)

10.4* ↓	9.8 ↑	10.6* ↑	10.2* ←	10.3* ↖
10.5* ↓	10.7* ↖	10.9* →	10.1 ↘	10.7* ↗

beste Teiler: 22.0 (18.), 70.2 (17.), 72.4 (20.)
Trefferkreis: 9.22 mm
Trefferlage: 0.03 mm links, 0.35 mm hoch

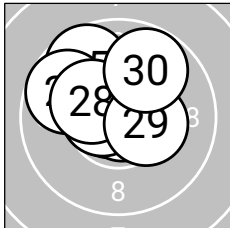

Serie 3: 103.1 (97)

10.8* ←	10.9* ↘	10.4* ↖	10.6* →	9.7 ↖
9.7 ↖	10.6* ←	10.3* ↖	10.3* →	9.8 ↗

beste Teiler: 25.0 (22.), 43.2 (21.), 85.3 (27.)
Trefferkreis: 9.22 mm
Trefferlage: 0.41 mm links, 0.82 mm hoch

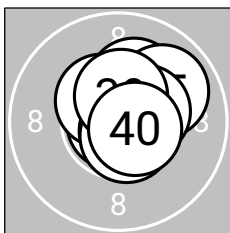

Serie 4: 105.0 (99)

10.9* ←	10.8* →	10.4* ↖	10.2* ↗	9.9 ↗
10.7* ↘	10.6* ↘	10.4* →	10.5* ↑	10.6* →

beste Teiler: 24.0 (31.), 39.5 (32.), 58.4 (36.)
Trefferkreis: 7.56 mm
Trefferlage: 0.51 mm rechts, 0.45 mm hoch



Ergebnis: **400.3** (387)
 Serien: 101.3 97.1 101.9 100.0
 Zähler: 27 13 0 0 0 0 0 0 0 0
 Innenzehner: 17
 Weitester: 468 (11.), 453 (36.), 433 (8.)
 beste Teiler: 90.3 (31.), 98.0 (9.), 118.6 (39.)
 Trefferkreis: 13.68 mm
 Trefferlage: 0.62 mm rechts, 0.59 mm hoch

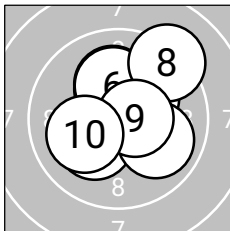
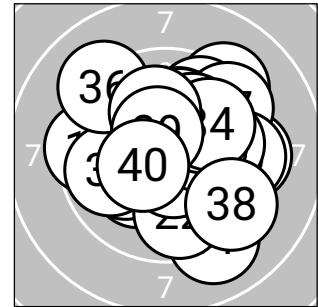

Serie 1: 101.3 (99)

10.2*↑	10.2*↗	10.1↑	10.5*↑	10.2*↖
10.2*↑	10.0↘	9.2↗	10.6*→	10.1↖

beste Teiler: 98.0 (9.), 120.5 (4.), 177.1 (1.)
 Trefferkreis: 10.86 mm
 Trefferlage: 0.33 mm rechts, 0.79 mm hoch

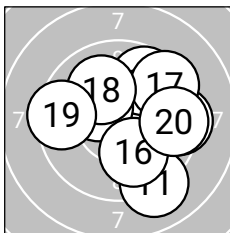

Serie 2: 97.1 (94)

9.1↘	10.2*↑	9.7↗	9.4→	10.3*↖
10.0↘	9.4↗	10.0↖	9.5←	9.5→

beste Teiler: 156.7 (15.), 185.3 (12.), 229.6 (18.)
 Trefferkreis: 12.60 mm
 Trefferlage: 1.01 mm rechts, 0.36 mm hoch

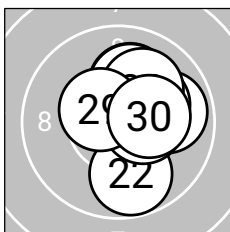

Serie 3: 101.9 (98)

9.9→	9.8↘	10.2*↗	10.5*↑	10.1↑
10.1↑	10.4*→	10.1↗	10.5*↖	10.3*→

beste Teiler: 119.2 (29.), 119.8 (24.), 135.0 (27.)
 Trefferkreis: 9.37 mm
 Trefferlage: 0.99 mm rechts, 0.66 mm hoch

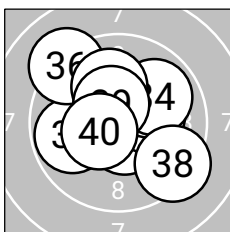

Serie 4: 100.0 (96)

10.6*↘	10.2*→	10.0↗	9.9↗	9.8←
9.1↖	10.1↑	9.3↘	10.5*↖	10.5*↖

beste Teiler: 90.3 (31.), 118.6 (39.), 123.0 (40.)
 Trefferkreis: 13.02 mm
 Trefferlage: 0.14 mm rechts, 0.54 mm hoch



Ergebnis: 416.1 (395)
Serien: 104.6 104.0 103.3 104.2
Zähler: 35 5 0 0 0 0 0 0 0 0
Innenzehner: 33
Weiteste: 280 (23.), 277 (16.), 258 (10.)
beste Teiler: 33.5 (26.), 41.2 (35.), 46.1 (3.)
Trefferkreis: 9.80 mm
Trefferlage: 0.09 mm rechts, 0.23 mm tief

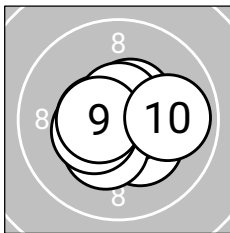
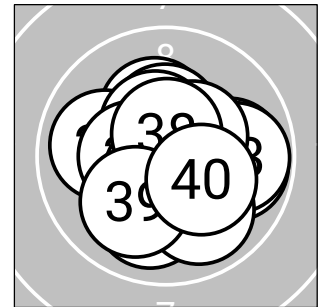

Serie 1: 104.6 (99)

10.3*↘	10.6*←	10.8*→	10.5*↗	10.7*↑
10.5*↙	10.3*↘	10.4*←	10.6*←	9.9→

beste Teiler: 46.1 (3.), 74.1 (5.), 100.0 (9.)
Trefferkreis: 8.40 mm
Trefferlage: 0.02 mm rechts, 0.23 mm tief

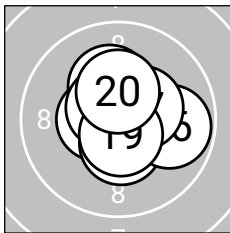

Serie 2: 104.0 (99)

10.2*↑	10.7*←	10.5*←	10.4*↓	10.4*→
9.8→	10.4*↗	10.6*↖	10.6*↓	10.4*↑

beste Teiler: 70.7 (12.), 82.2 (19.), 85.6 (18.)
Trefferkreis: 8.48 mm
Trefferlage: 0.27 mm rechts, 0.18 mm hoch

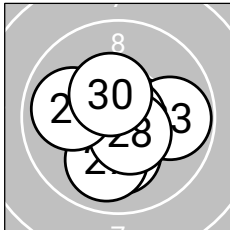

Serie 3: 103.3 (98)

10.6*→	10.6*←	9.8→	10.5*↖	10.2*↓
10.8*→	10.0↓	10.5*↘	9.9←	10.4*↖

beste Teiler: 33.5 (26.), 85.1 (21.), 99.5 (22.)
Trefferkreis: 9.80 mm
Trefferlage: 0.01 mm links, 0.31 mm tief

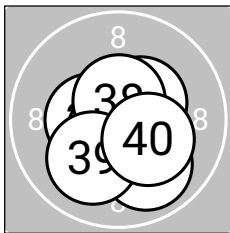

Serie 4: 104.2 (99)

10.5*↙	10.5*↘	10.4*←	9.9↘	10.8*→
10.4*↗	10.7*↘	10.6*↑	10.1↙	10.3*↘

beste Teiler: 41.2 (35.), 75.9 (37.), 91.0 (38.)
Trefferkreis: 8.12 mm
Trefferlage: 0.10 mm rechts, 0.56 mm tief



LG 40 ZR

StandNr: 119

Kreisser, Christine #70819146

Senioren_2w

Wertung

StartNr: 252

01.03.2026 17:09

SG_Bad-Häring

SG Bad-Häring 1

Ergebnis: **416.1** (397)
 Serien: 103.8 104.6 103.9 103.8
 Zähler: 37 3 0 0 0 0 0 0 0 0
 Innenzehner: 31
 Weitester: 305 (30.), 282 (26.), 280 (31.)
 beste Teiler: 6.0 (36.), 43.2 (21.), 47.1 (18.)
 Trefferkreis: 9.47 mm
 Trefferlage: 0.32 mm links, 0.22 mm tief

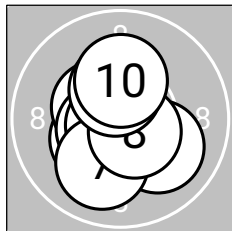
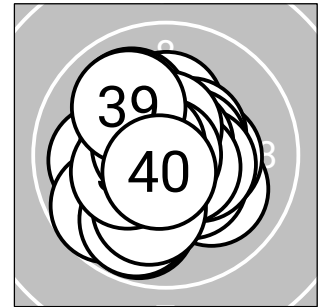
**Serie 1: 103.8** (100)

10.3*↓	10.3*↙	10.5*↖	10.1↘	10.6*↗
10.8*↘	10.0↓	10.6*↘	10.4*↑	10.2*↑

beste Teiler: 50.8 (6.), 93.5 (8.), 98.4 (5.)
 Trefferkreis: 8.68 mm
 Trefferlage: 0.26 mm links, 0.34 mm tief

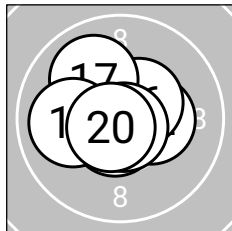
**Serie 2: 104.6** (100)

10.7*↓	10.3*→	10.4*↖	10.5*↖	10.7*↖
10.5*↗	10.0↖	10.8*↘	10.0←	10.7*↘

beste Teiler: 47.1 (18.), 54.0 (15.), 65.7 (20.)
 Trefferkreis: 8.52 mm
 Trefferlage: 0.42 mm links, 0.26 mm hoch

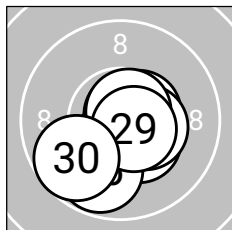
**Serie 3: 103.9** (98)

10.8*↗	10.6*↘	10.4*↓	10.4*↘	10.5*↗
9.8↓	10.4*↘	10.7*↗	10.6*↘	9.7↘

beste Teiler: 43.2 (21.), 62.2 (28.), 81.0 (22.)
 Trefferkreis: 8.55 mm
 Trefferlage: 0.17 mm rechts, 0.70 mm tief

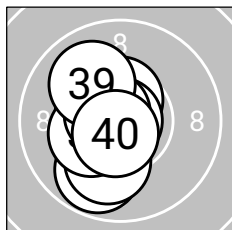
**Serie 4: 103.8** (99)

9.8↓	10.4*↖	10.5*↑	10.5*↖	10.1↓
10.9*↖	10.3*↖	10.6*↖	10.0↖	10.7*↘

beste Teiler: 6.0 (36.), 71.8 (40.), 76.9 (38.)
 Trefferkreis: 8.96 mm
 Trefferlage: 0.78 mm links, 0.09 mm tief

Ergebnis: 413.2 (397)
Serien: 104.1 101.9 104.6 102.6
Zähler: 37 3 0 0 0 0 0 0 0 0
Innenzehner: 30
Weiteste: 443 (16.), 385 (35.), 267 (31.)
beste Teiler: 17.4 (10.), 48.8 (27.), 60.8 (39.)
Trefferkreis: 11.27 mm
Trefferlage: 0.49 mm links, 0.28 mm hoch

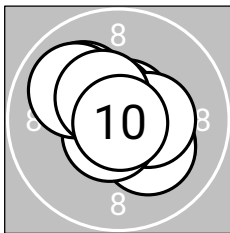
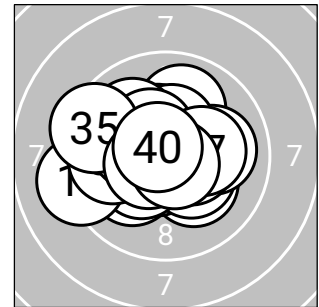

Serie 1: 104.1 (100)

10.2*↘	10.7*↗	10.6*↖	10.2*↘	10.4*↔
10.6*↙	10.1↖	10.0↖	10.4*↖	10.9*↘

beste Teiler: 17.4 (10.), 69.4 (2.), 78.5 (6.)
Trefferkreis: 8.86 mm
Trefferlage: 0.05 mm links, 0.18 mm hoch

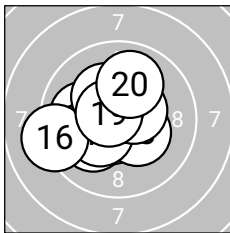

Serie 2: 101.9 (99)

10.1↖	10.6*↙	10.3*↘	10.0↖	10.3*↖
9.2↖	10.5*↗	10.2*↖	10.7*↖	10.0↗

beste Teiler: 74.8 (19.), 90.7 (12.), 120.5 (17.)
Trefferkreis: 10.71 mm
Trefferlage: 0.84 mm links, 0.01 mm hoch

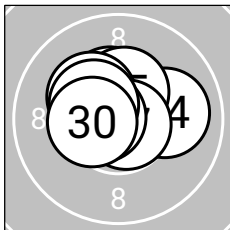

Serie 3: 104.6 (100)

10.6*↖	10.4*↗	10.7*↗	10.0↔	10.4*↗
10.3*↖	10.8*↘	10.6*↖	10.4*↖	10.4*↖

beste Teiler: 48.8 (27.), 74.8 (23.), 86.4 (28.)
Trefferkreis: 8.28 mm
Trefferlage: 0.26 mm links, 0.52 mm hoch

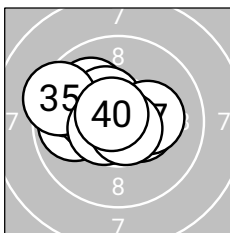

Serie 4: 102.6 (98)

9.9↖	10.3*↖	10.0↖	10.4*↖	9.4↖
10.4*↔	10.2*↔	10.6*↖	10.7*↘	10.7*↖

beste Teiler: 60.8 (39.), 60.8 (40.), 95.7 (38.)
Trefferkreis: 10.01 mm
Trefferlage: 0.80 mm links, 0.42 mm hoch



Ergebnis: **408.1** (389)
 Serien: 98.8 101.5 103.7 104.1
 Zähler: 29 11 0 0 0 0 0 0 0 0
 Innenzehner: 24
 Weitester: 370 (3.), 358 (7.), 333 (6.)
 beste Teiler: 51.6 (37.), 72.4 (24.), 78.4 (34.)
 Trefferkreis: 9.43 mm
 Trefferlage: 1.49 mm rechts, 0.30 mm hoch

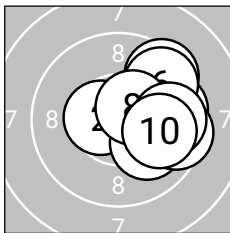
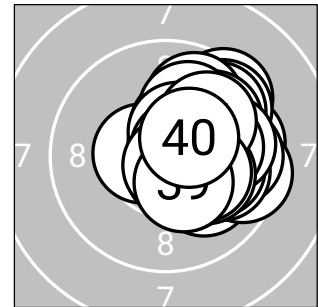

Serie 1: 98.8 (93)

9.8➔ 10.5*← 9.5↗ 10.1↘ 9.7➔
 9.6↗ 9.5➔ 10.5*↗ 9.7➔ 9.9➔

beste Teiler: 106.6 (2.), 114.2 (8.), 222.0 (4.)
 Trefferkreis: 9.43 mm
 Trefferlage: 2.18 mm rechts, 0.32 mm hoch

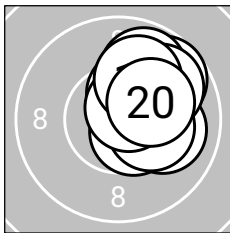

Serie 2: 101.5 (97)

9.7↗ 10.0➔ 10.6*↘ 10.4*↗ 10.3*➔
 9.8↗ 10.6*↗ 9.9↗ 10.0↗ 10.2*↗

beste Teiler: 80.7 (17.), 99.6 (13.), 146.7 (14.)
 Trefferkreis: 7.71 mm
 Trefferlage: 1.42 mm rechts, 0.94 mm hoch

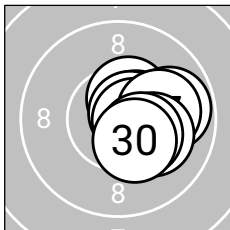

Serie 3: 103.7 (99)

10.5*↗ 10.5*↗ 10.5*↗ 10.7*↗ 9.8➔
 10.6*➔ 10.1➔ 10.2*↘ 10.4*↘ 10.4*↘

beste Teiler: 72.4 (24.), 84.2 (26.), 101.2 (23.)
 Trefferkreis: 7.24 mm
 Trefferlage: 1.29 mm rechts, 0.02 mm hoch

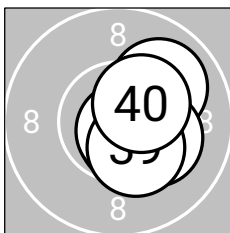

Serie 4: 104.1 (100)

10.5*➔ 10.4*↘ 10.3*↗ 10.6*↘ 10.6*➔
 10.0↗ 10.7*↘ 10.2*↘ 10.4*↘ 10.4*↗

beste Teiler: 51.6 (37.), 78.4 (34.), 84.3 (35.)
 Trefferkreis: 7.45 mm
 Trefferlage: 1.06 mm rechts, 0.06 mm tief

Ergebnis: **416.7** (398)
 Serien: 105.0 102.9 103.5 105.3
 Zähler: 38 2 0 0 0 0 0 0 0 0
 Innenzehner: 33
 Weitester: 272 (11.), 254 (4.), 242 (18.)
 beste Teiler: 34.0 (1.), 50.6 (28.), 56.3 (38.)
 Trefferkreis: 9.10 mm
 Trefferlage: 0.31 mm rechts, 0.18 mm hoch

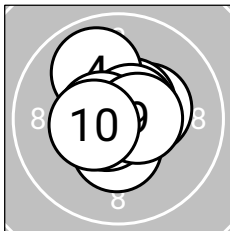
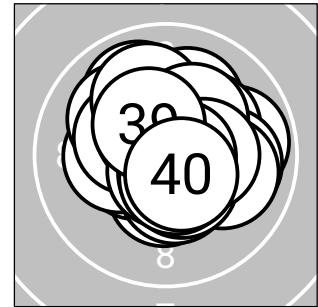

Serie 1: 105.0 (99)

10.8*↑	10.3*↗	10.6*↗	9.9↖	10.4*↓
10.7*↙	10.6*↗	10.6*↖	10.6*↗	10.5*↖

beste Teiler: 34.0 (1.), 66.7 (6.), 78.6 (7.)
 Trefferkreis: 8.33 mm
 Trefferlage: 0.01 mm links, 0.25 mm hoch

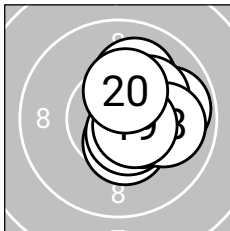

Serie 2: 102.9 (99)

9.9→	10.4*↓	10.4*→	10.6*↓	10.1↗
10.4*→	10.2*↗	10.0→	10.6*→	10.3*↑

beste Teiler: 92.0 (14.), 95.4 (19.), 129.5 (13.)
 Trefferkreis: 7.94 mm
 Trefferlage: 1.22 mm rechts, 0.19 mm hoch

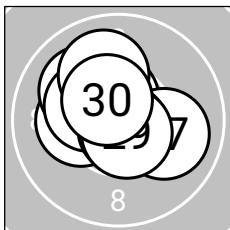

Serie 3: 103.5 (100)

10.4*↖	10.2*↖	10.5*↑	10.1↖	10.3*↖
10.0↑	10.0→	10.8*↓	10.7*↓	10.5*↖

beste Teiler: 50.6 (28.), 75.7 (29.), 105.5 (23.)
 Trefferkreis: 8.99 mm
 Trefferlage: 0.46 mm links, 0.53 mm hoch

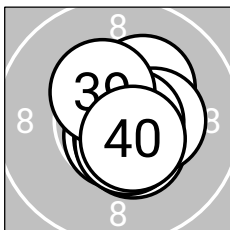

Serie 4: 105.3 (100)

10.3*↗	10.7*↓	10.5*↓	10.5*↓	10.6*↓
10.6*↓	10.4*→	10.7*→	10.4*↖	10.6*↓

beste Teiler: 56.3 (38.), 64.6 (32.), 79.6 (35.)
 Trefferkreis: 7.24 mm
 Trefferlage: 0.50 mm rechts, 0.22 mm tief

LG 40 ZR

StandNr: 123

Felderer, Maria-Luise #70817343

Senioren_2w

Wertung

StartNr: 256

01.03.2026 17:00

SG_Breitenbach

SG Breitenbach 1

Ergebnis: **413.9** (394)
 Serien: 103.2 104.7 104.7 101.3
 Zähler: 34 6 0 0 0 0 0 0 0 0
 Innenzehner: 30
 Weitester: 497 (35.), 336 (1.), 330 (25.)
 beste Teiler: 7.8 (14.), 11.4 (27.), 20.8 (40.)
 Trefferkreis: 12.05 mm
 Trefferlage: 0.18 mm links, 0.39 mm tief

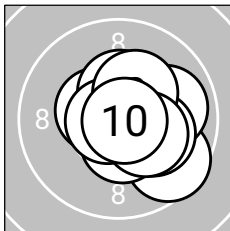
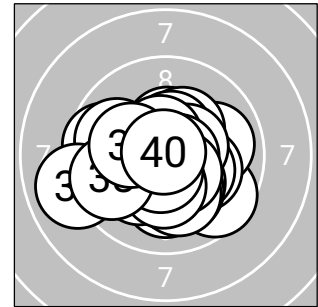

Serie 1: 103.2 (98)

9.6 ↘	9.9 →	10.5* ↓	10.2** ↘	10.5** ↖
10.4* ↑	10.7* ↖	10.3* ↗	10.3** ↘	10.8** →

beste Teiler: 34.4 (10.), 56.0 (7.), 115.1 (3.)
 Trefferkreis: 9.00 mm
 Trefferlage: 0.82 mm rechts, 0.12 mm tief

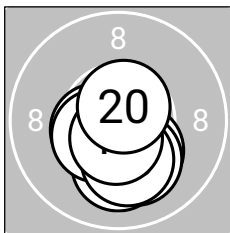

Serie 2: 104.7 (100)

10.1 ↓	10.5* ↖	10.3* ↘	10.9* ↖	10.8* ↓
10.5* ↖	10.1 ↓	10.2* ↓	10.6* ↓	10.7* ↗

beste Teiler: 7.8 (14.), 33.8 (15.), 71.8 (20.)
 Trefferkreis: 7.32 mm
 Trefferlage: 0.01 mm rechts, 0.91 mm tief

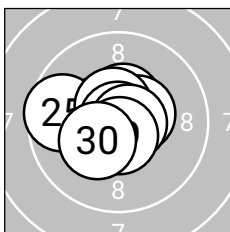

Serie 3: 104.7 (99)

10.5* ↖	10.5* ↑	10.5* ↑	10.5* →	9.6 ↖
10.6* ↑	10.9* ↑	10.7** →	10.6* ↓	10.3* ↖

beste Teiler: 11.4 (27.), 59.3 (28.), 79.3 (29.)
 Trefferkreis: 8.84 mm
 Trefferlage: 0.34 mm links, 0.28 mm hoch

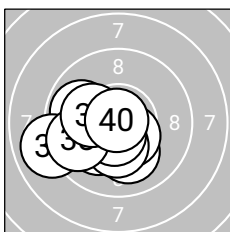

Serie 4: 101.3 (97)

10.1 ↓	10.5* ↘	10.1 ↖	9.9 ↖	9.0 ↖
10.3* ↓	10.6* ↓	9.7 ↖	10.2** ↖	10.9** ↖

beste Teiler: 20.8 (40.), 85.3 (37.), 118.8 (32.)
 Trefferkreis: 9.98 mm
 Trefferlage: 1.24 mm links, 0.82 mm tief



Ergebnis: 412.9 (395)
Serien: 102.7 103.9 103.4 102.9
Zähler: 35 5 0 0 0 0 0 0 0 0
Innenzehner: 28
Weiteste: 344 (9.), 306 (32.), 300 (5.)
beste Teiler: 21.9 (3.), 22.8 (37.), 26.9 (2.)
Trefferkreis: 10.22 mm
Trefferlage: 0.03 mm links, 0.42 mm hoch

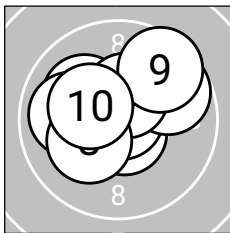
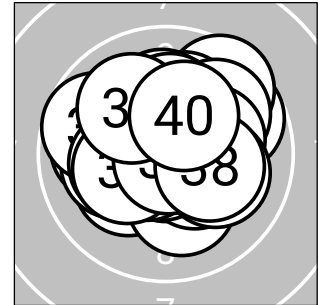

Serie 1: 102.7 (97)

10.7* \downarrow 10.8* \leftarrow 10.9* \rightarrow 10.1 \leftarrow 9.8 \rightarrow
 10.4* \uparrow 9.9 \leftarrow 10.2* \leftarrow 9.6 \rightarrow 10.3* \leftarrow

beste Teiler: 21.9 (3.), 26.9 (2.), 74.2 (1.)
Trefferkreis: 9.86 mm
Trefferlage: 0.17 mm links, 0.61 mm hoch

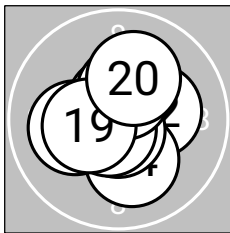

Serie 2: 103.9 (100)

10.6* \rightarrow 10.2* \rightarrow 10.1 \leftarrow 10.1 \downarrow 10.7* \downarrow
 10.6* \uparrow 10.7* \leftarrow 10.4* \uparrow 10.4* \leftarrow 10.1 \uparrow

beste Teiler: 53.0 (15.), 63.7 (17.), 76.6 (16.)
Trefferkreis: 8.65 mm
Trefferlage: 0.00 mm , 0.14 mm hoch

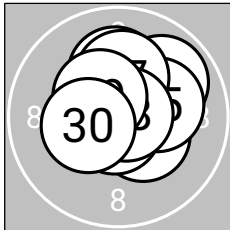

Serie 3: 103.4 (99)

10.2* \rightarrow 9.9 \rightarrow 10.4* \rightarrow 10.8* \downarrow 10.2* \rightarrow
 10.1 \uparrow 10.2* \uparrow 10.8* \rightarrow 10.4* \leftarrow 10.4* \leftarrow

beste Teiler: 39.5 (28.), 50.9 (24.), 130.9 (29.)
Trefferkreis: 8.56 mm
Trefferlage: 0.41 mm rechts, 0.69 mm hoch

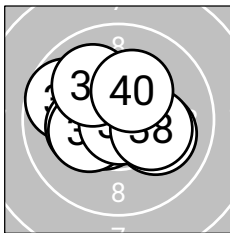

Serie 4: 102.9 (99)

10.6* \leftarrow 9.7 \leftarrow 10.6* \uparrow 10.1 \rightarrow 10.2* \leftarrow
 10.3* \leftarrow 10.9* \downarrow 10.2* \rightarrow 10.0 \leftarrow 10.3* \uparrow

beste Teiler: 22.8 (37.), 91.5 (31.), 98.6 (33.)
Trefferkreis: 9.75 mm
Trefferlage: 0.38 mm links, 0.25 mm hoch

